

# **Screening for Environmental Hazards at Sites with Contaminated Soil and Groundwater**

## **Volume 2: Background Documentation for the Development of Tier 1 Environmental Action Levels**

### **Appendix 6**

Prepared by:

**Hawai'i Department of Health  
Environmental Management Division  
2385 Waimano Home Road  
Pearl City, Hawai'i 96782**

**Draft Spring 2024**

**Contacts:**

Roger Brewer  
Hawai'i Department of Health  
Environmental Management Division  
Hazard Evaluation and Emergency Response  
Telephone: 1-808-586-4249  
E-mail: roger.brewer@doh.hawaii.gov  
<http://hawaii.gov/health/environmental/hazard/index.html>

OR

Roxanne Kwan  
Hawai'i Department of Health  
Environmental Management Division  
Solid and Hazard Waste Branch  
Telephone: 1-808-586-4226  
E-mail: roxanne.kwan@doh.hawaii.gov

**DISCLAIMER**

This document, *Evaluation of Environmental Hazards at Sites with Contaminated Soil and Groundwater* (Spring 2024), is a technical report prepared by staff of the Hawai'i Department of Health (HDOH), Environmental Management Division. The document updates and replaces the Summer 2017 edition of the same document. A summary of the Spring 2024 updates is provided in Appendix 9.

The document provides guidance for identification and evaluation of environmental hazards associated with contaminated soil and groundwater. The Environmental Action Levels (EALs) presented in this document and the accompanying text are specifically *not* intended to serve as: 1) a stand-alone decision making tool, 2) guidance for the preparation of baseline environmental risk assessments, 3) a rule to determine if a waste is hazardous under the state or federal regulations, or 4) a rule to determine when the release of hazardous substances must be reported to the HDOH.

The information presented in this document is not final action. HDOH reserves the right to change this information at any time without public notice. This document is not intended, nor can it be relied upon, to create any rights enforceable by any party in litigation in areas associated with HDOH. HDOH may elect to follow the information provided herein or act at a variance with the information, based on an analysis of site-specific circumstances.

This document will be periodically updated. Please send comments, edits, etc. in writing to the above contact. This document is not copyrighted. Copies may be freely made and distributed. It is cautioned, however, that reference to the action levels presented in this document without adequate review of the accompanying narrative could result in misinterpretation and misuse of the information. Comments and suggestions for updates are welcome at any time.

## VOLUME 2: BACKGROUND DOCUMENTATION FOR THE DEVELOPMENT OF TIER 1 SOIL AND GROUNDWATER ACTION LEVELS

### APPENDICES

- 1 DEVELOPMENT OF TIER 1 LOOKUP TABLES
- 2 SUMMARY OF HUMAN HEALTH RISK-BASED EQUATIONS AND DEFAULT INPUT PARAMETER VALUES; USEPA REGIONAL SCREENING LEVELS USER'S GUIDE (MAY 2016)
- 3 RELEVANT PORTIONS OF *USER'S GUIDE FOR THE JOHNSON AND ETTINGER (1991) MODEL FOR SUBSURFACE VAPOR INTRUSION INTO BUILDINGS*; SENSITIVITY ANALYSIS OF *JOHNSON AND ETTINGER (1991) MODEL*
- 4 EXAMPLE PRINTOUTS OF VAPOR INTRUSION MODELS
- 5 DEVELOPMENT OF SOIL LEACHING SCREENING LEVELS
- 6 DEVELOPMENT OF CARBON RANGE AND TOTAL PETROLEUM HYDROCARBON RISK-BASED ACTION LEVELS
- 7 DETERMINATION OF GROUNDWATER UTILITY (HDOH 1995)
- 8 SUPPLEMENTAL HDOH TECHNICAL GUIDANCE DOCUMENTS
- 9 UPDATES TO 2011 EHE GUIDANCE DOCUMENT

### GLOSSARY OF TERMS

AWQC: Aquatic Water Quality Criteria  
CCC: Criterion for Continuous Concentration  
CCM: Criterion for Maximum Concentration  
EPA: Environmental Protection Agency  
ESL: Environmental Screening Level  
FVC: Final Chronic Value  
HDOH: Hawai'i Department of Health  
HH: Human Health-consumption of aquatic organisms  
LOEL: Lowest-Observed-Effects Level  
MADEP: Massachusetts Department of Environmental Protection  
MCL: Maximum Concentration Level  
MOEE: Ontario Ministry of Environment and Energy  
MTBE: Methyl tert-Butyl Ethylene  
PCE: Tetrachloroethylene  
PRG: Preliminary Remediation Goals  
RBSL: Risk-Based Screening Level  
RSL: Regional Screening Level  
RWQCB: Regional Water Quality Control Board  
TPH: Total Petroleum Hydrocarbons  
USEPA: U.S. Environmental Protection Agency  
USDOE: U.S. Department of Energy

# APPENDIX 6

## DEVELOPMENT OF CARBON RANGE AND TOTAL PETROLEUM HYDROCARBON RISK-BASED ACTION LEVELS

- Chemistry and Toxicity of Petroleum Fuels (HDOH 2024)
- JP-5 Water-Fuel Study Laboratory Report (HIDOH 2023b)
- Chemistry and Toxicity of Petroleum Vapors (Brewer et al (2013)
- Common TPH questions (HDOH 2012)
- 2002 Massachusetts VPH-EPH Guidance
- Overview of gasoline composition (NEIWPC, 2003)
- Use of TPH Action Levels (HDOH 2024)
- Forensic Drinking Water Characterization (Newfields January 2024)

# **HDOH Laboratory Study of the Chemistry and Toxicity of Petroleum Fuels -Summary Text and Tables-**

## Methods

### 1.0 Introduction

A detailed laboratory study of the benzene, toluene, ethylbenzene, xylene, methylnaphthalene and naphthalene (BTEXMN) and carbon range makeup of several gasolines, middle distillates and heavy oils was carried out by Newfields Environmental (Newfields 2022) on behalf of the Hawaii Department of Health (HDOH). A copy of the report is included as an attachment to this appendix. Descriptive summaries of the data are provided in Section 6 of Appendix 1. Detailed summaries for each fuel type are provided in Tables 1-5 below. The results are used in subsequent, detailed tables to describe calculation of weighted, Total Petroleum Hydrocarbon (TPH) toxicity factors for gasoline, diesel and Bunker C (Fuel Oil #6). The resulting toxicity factors are utilized to calculate risk-based action levels for TPH associated with gasolines, middle distillate fuels and residual fuels in Appendix 1 of the EHE guidance.

### 2.0 Predicted Makeup of Dissolved-Phase Petroleum Fuels in Water

The carbon range and BTEXMN makeup of dissolved-phase fuel in water that is in contact with fresh product can be estimated based on the weight percent and effective solubility of compounds in the parent fuel mixture. The effective solubility of individual components of a fuel is calculated in accordance with Raoult's Law as (after O'Reilly et al. 2001):

$$C_i = x_i \times S_i \quad \text{Eq 1)}$$

where:

$C_i$  = Effective solubility of the compound;

$x_i$  = Mole fraction; and

$S_i$  = Pure component solubility.

The mole fraction reflects the ratio of the number of moles of one component of a solution to the total number of moles representing all of the components, in this case TPH carbon ranges and BTEXMN, and is calculated as

$$x_i = \left[ \frac{\frac{w_i \times 0.01}{MW_i}}{\frac{1}{MW_{ave}}} \right] \quad \text{Eq 2)}$$

where:

$w_i$  = Weight percent of the constituent in the mixture (converted to a fraction);

$MW_i$  = Average molecular weight of the constituent; and

$MW_{ave}$  = Average molecular weight of the mixture.

The equation assumes that the total mass of the fuel is equal to one mole.

Equations 1 and 2 can be simplified to:

$$C_i = \left( \frac{w_i \times 0.01}{MW_i} \times MW_{ave} \right) \times S_i \quad \text{Eq 3)}$$

Physiochemical constants for BTEXMN and carbon range compounds, including molecular weights, are provided in Table 7. Default molecular weights assigned to individual fuel types are provided in the footnotes to Table A for each fuel in attached summary tables. This equation can be used to calculate effective solubilities for BTEXMN and carbon ranges based on published data for various fuel types. The effective solubilities are assumed to reflect the relative makeup of dissolved-phase hydrocarbons in water that is in direct contact with fresh product.

### 3.0 Calculation of Weighted Toxicity Factors

#### *Weighted Harmonic Means*

Selected toxicity factors for BTEXMN and individual carbon range compounds are noted in Table 6. The harmonic mean weighted to the relative proportion of targeted compounds in a mixture is used to calculate weighted toxicity factors for dissolved-phase mixtures (ORDEQ 2003). Use of the harmonic mean rather than arithmetic average biases the results to the more toxic component of the mixture. Weighted toxicity factors for non-degraded compounds consider only the non-BTEXMN carbon range fraction of the mixture. Remaining BTEXMN compounds are assumed to be tested for and assessed separately. The weighted toxicity of degraded mixtures is, in contrast, based on the relative proportion of the combined carbon range and BTEXMN compounds in the original mixture.

#### *Weighted Toxicity Factors*

Weighted, oral Reference Doses (RfDs) are calculated as:

$$\text{Weighted RfD}_{\text{oral}} \text{ (mg/kg-day)} = \frac{1}{\left[ \frac{(\% \text{ Fraction A})}{\text{Fraction A RfD}_{\text{oral}}} + \frac{(\% \text{ Fraction B})}{\text{Fraction B RfD}_{\text{oral}}} + \text{etc.} \right]} \quad \text{Eq 4)}$$

where:

% Fraction “X” = Percent makeup of the subject carbon range fraction +/- BTEXMN relative to the total concentration of measured carbon ranges;

Fraction “X” Toxicity Factor = Toxicity factor assigned to subject carbon range fraction +/- BTEXMN.

Weighted toxicity factors for dermal exposure are calculated using a similar approach:

$$\text{Weighted RfD}_{\text{dermal}} \text{ (mg/kg-day)} = \frac{1}{\left[ \frac{(\% \text{ Fraction A})}{\text{Fraction A RfD}_{\text{dermal}}} + \frac{(\% \text{ Fraction B})}{\text{Fraction B RfD}_{\text{dermal}}} + \text{etc.} \right]} \quad \text{Eq 5)}$$

Dermal toxicity factors for non-degraded mixtures focus on more soluble and less volatile, C13+ aromatic compounds. Calculation of weighted, dermal toxicity factors for degraded mixtures again requires consideration of combined, original carbon range and BTEXMN mixture.

Weighted Reference Concentrations (RfCs) applicable to the inhalation exposure focus on volatile aromatic and aliphatic carbon ranges but were otherwise calculated in a similar manner:

$$\text{Weighted RfC} \text{ (}\mu\text{g/m}^3\text{)} = \frac{1}{\left[ \frac{(\% \text{ Fraction A})}{\text{Fraction A RfC}} + \frac{(\% \text{ Fraction B})}{\text{Fraction B RfC}} + \text{etc.} \right]} \quad \text{Eq 6)}$$

Inhalation toxicity factors for non-degraded compounds focus on the relative makeup of volatile, C5-C12 aliphatic and C9-C12 aromatic carbon ranges in the dissolved-phase mixture. Inhalation toxicity factors are again not calculated for since degraded carbon range and BTEXMN compounds are assumed to be of low volatility.

## References

ATSDR, 1995, Toxicological Profile for Gasoline: Agency for Toxic Substances and Disease Registry, June 1995.

CountryMark, 2021, No. 6 Fuel Oil, Material Safety Data Sheet: Countrymark Refining and Logistics, LLC, December 2012.

Gustafson, J.B., Tell, J.G. and D. Orem, 1997. Selection of Representative TPH Fractions Based on Fate and Transport Considerations: Total Petroleum Hydrocarbon Working Group Series; Association for Environmental Health and Sciences: Amherst, MA, USA, Volume 3. ISBN 1-884-940-12-9.

IARC, 1989, IARC Monographs on the Evaluation of Carcinogenic Risks to Humans: International Agency for Research on Cancer, No. 45., Lyon, France.  
<https://www.ncbi.nlm.nih.gov/books/NBK531265/>

Newfields, 2022, Supplemental Analytical Data in Support of Hawaii Department of Health Fuel Study: Newfields Environmental, October 28, 2022.

NRC, 1996, Permissible Exposure Levels for Selected Military Fuel Vapors: National Research Council, Subcommittee on Permissible Exposure Levels for Military Fuels, National Academies Press, Washington, D.C.

ORDEQ, 2003, Risk-Based Decision Making for the Remediation of Petroleum- Contaminated Sites: Oregon Department of Environmental Quality, Environmental Cleanup and Tanks Program, September 2003.

O'Reilly, K.T., McGaw, R.I and W.G. Rixey, 2001, Predicting the Effect of Hydrocarbon and Hydrocarbon-Impacted Soil on Groundwater: American Petroleum Institute, September 2001, Bulletin No. 14.

USEPA, 2023, Regional Screening Levels: U.S. Environmental Protection Agency, November 2023, prepared by Oak Ridge National Laboratories, <https://www.epa.gov/risk/regional-screening-levels-rsls-generic-tables>



# Fuel Study Data Summary

Table 1. Unadjusted fuel makeup data reported for fuel samples (Newfields 2022).

Analytes	GASOLINE 87			GASOLINE 87 (Duplicate)			GASOLINE 91			GASOLINE 93			HEATING FUEL		
	mg/kg	Flag	RL	mg/kg	Flag	RL	mg/kg	Flag	RL	mg/kg	Flag	RL	mg/kg	Flag	RL
Benzene	9,120	D		9,230	D		8,770	D		8,810	D		31	JD	
Toluene	50,200	D		49,400	D		47,600	D		50,200	D		110	D	
Ethylbenzene	11,800	D		11,600	D		10,600	D		11,300	D		344	D	
Xylenes	63,200			62,100			57,100			60,100			2,347		
1-Methylnapthalene	488	D		577	D		473	D		407	D		1,280	D	
2-Methylnapthalene	1,040	D		1,250	D		1,010	D		882	D		2,180	D	
Naphthalene	1,850	D		2,090	D		1,790	D		1,540	D		790	D	
<b>Total BTEXMN:</b>	<b>137,698</b>			<b>136,247</b>			<b>127,343</b>			<b>133,239</b>			<b>7,082</b>		
C5-C6 Aliphatics	170,700		94	163,393		94	190,941		98	183,440		88		U	98
>C6-C8 Aliphatics	180,170		94	175,110		94	179,301		98	172,496		88	1,059		98
>C8-C10 Aliphatics	36,595		3,130	42,871		3,130	38,359		3,210	33,345		2,930	23,794		2,940
>C10-C12 Aliphatics	11,737		3,130	13,428		3,130	11,464		3,210	9,562		2,930	80,983		2,940
>C12-C16 Aliphatics	2,667	J	3,130	2,843	J	3,130	2,275	J	3,210	2,069	J	2,930	203,122		2,940
>C16-C21 Aliphatics		U	3,130		U	3,130		U	3,210		U	2,930	166,328		2,940
>C21-C32 Aliphatics		U	3,130		U	3,130		U	3,210		U	2,930	33,481		2,940
>C8-C10 Aromatics	73,977		3,130	74,732		3,130	62,778		3,210	65,763		2,930	6,507		2,940
>C10-C12 Aromatics	26,981		3,130	27,755		3,130	22,066		3,210	24,006		2,930	30,293		2,940
>C12-C16 Aromatics	4,315		3,130	4,564		3,130	3,524		3,210	3,847		2,930	111,016		2,940
>C16-C21 Aromatics		U	3,130		U	3,130		U	3,210		U	2,930	82,640		2,940
>C21-C32 Aromatics		U	3,130		U	3,130		U	3,210		U	2,930	15,036		2,940
<sup>1</sup> Total Carbon Ranges:	<b>507,143</b>			<b>504,696</b>			<b>510,709</b>			<b>494,527</b>			<b>754,259</b>		
<b>Total BTEXMN + Carbon Ranges:</b>	<b>644,841</b>			<b>640,943</b>			<b>638,052</b>			<b>627,766</b>			<b>761,342</b>		
<b>Unaccounted Mass:</b>	<b>355,159</b>			<b>359,057</b>			<b>361,948</b>			<b>372,234</b>			<b>238,658</b>		
<sup>1</sup> Percent Unaccounted Mass for Total Data:	<b>36%</b>			<b>36%</b>			<b>36%</b>			<b>37%</b>			<b>24%</b>		
<sup>2</sup> Percent Unaccounted Carbon Range Mass:	<b>70%</b>			<b>71%</b>			<b>71%</b>			<b>75%</b>			<b>32%</b>		

Table 1 (cont.). Unadjusted fuel makeup data reported for fuel samples (Newfields 2022).

Analytes	ROAD DIESEL			JP-5			JP-8			BUNKER C			WASTE OIL (AUTO)		
	mg/kg	Flag	RL	mg/kg	Flag	RL	mg/kg	Flag	RL	mg/kg	Flag	RL	mg/kg	Flag	RL
Benzene	90	JD		40	JD		129	JD		11	JBD		11	B	
Toluene	674	D		252	D		3,070	D		8.3	JD		248		
Ethylbenzene	1,600	D		492	D		5,400	D		5.5	JD		161		
Xylenes	11,630			2,495			36,900			35			988		
1-Methylnapthalene	896	D		4,810	D		4,680	D		913	D		506		
2-Methylnapthalene	1,650	D		6,900	D		7,550	D		1,620	D		945		
Napthalene	560	D		3,490	D		4,050	D		1,120	D		386		
<b>Total BTEXMN:</b>	<b>17,100</b>			<b>18,479</b>			<b>61,779</b>			<b>3,713</b>			<b>3,245</b>		
C5-C6 Aliphatics	553		91	378		200	3,250		200		U	37	110		9.9
>C6-C8 Aliphatics	4,410		91	3,134		200	29,433		200		U	37	494		9.9
>C8-C10 Aliphatics	31,373		2,950	60,460		1,650	151,534		1,650		U	3,190		U	2,950
>C10-C12 Aliphatics	61,092		2,950	278,612		1,650	180,422		1,650	14,228		3,190		U	2,950
>C12-C16 Aliphatics	196,045		2,950	315,662		1,650	234,688		1,650	51,074		3,190	1,822	J	2,950
>C16-C21 Aliphatics	212,713		2,950	2,264		1,650	20,794		1,650	68,425		3,190	9,434		2,950
>C21-C32 Aliphatics	35,117		2,950		U	1,650		U	1,650	182,967		3,190	652,672		2,950
>C8-C10 Aromatics	22,417		2,950	7,506		1,650	30,291		1,650		U	3,190	2,177	J	2,950
>C10-C12 Aromatics	42,287		2,950	55,836		1,650	39,115		1,650	6,891		3,190	3,629		2,950
>C12-C16 Aromatics	110,031		2,950	90,500		1,650	73,316		1,650	30,159		3,190	4,970		2,950
>C16-C21 Aromatics	75,319		2,950	1,696		1,650	5,797		1,650	37,074		3,190	6,738		2,950
>C21-C32 Aromatics	12,839		2,950		U	1,650		U	1,650	84,564		3,190	60,655		2,950
<b><sup>1</sup>Total Carbon Ranges:</b>	<b>804,196</b>			<b>816,049</b>			<b>768,640</b>			<b>475,383</b>			<b>742,702</b>		
<b>Total BTEXMN + Carbon Ranges:</b>	<b>821,296</b>			<b>834,527</b>			<b>830,419</b>			<b>479,096</b>			<b>745,947</b>		
<b>Unaccounted Mass:</b>	<b>178,704</b>			<b>165,473</b>			<b>169,581</b>			<b>520,904</b>			<b>254,053</b>		
<b><sup>1</sup>Percent Unaccounted Mass for Total Data:</b>	<b>18%</b>			<b>17%</b>			<b>17%</b>			<b>52%</b>			<b>25%</b>		
<b><sup>2</sup>Percent Unaccounted Carbon Range Mass:</b>	<b>22%</b>			<b>20%</b>			<b>22%</b>			<b>110%</b>			<b>34%</b>		

**Notes:**

Laboratory Data Flags: D = Sample Diluted; J = Concentration below the Method Reporting Limit (RL); U = Not detected.

1. Percent unaccounted mass necessary for sum of BTEXMN and total carbon range data to be 1,000,000 mg/kg.
2. Percent unaccounted mass attributable to carbon range data error assuming that BTEXMN data are accurate.

Table 2. <sup>1</sup>Adjustment of fuel makeup data to account for unreported carbon range mass (refer to Table 1).

Analytes	GASOLINE 87 (mg/kg)	GASOLINE 87 (Dup) (mg/kg)	GASOLINE 91 (mg/kg)	GASOLINE 93 (mg/kg)	HEATING FUEL (mg/kg)
Benzene	9,120	9,230	8,770	8,810	31
Toluene	50,200	49,400	47,600	50,200	110
Ethylbenzene	11,800	11,600	10,600	11,300	344
Xylenes	63,200	62,100	57,100	60,100	2,347
1-Methylnaphthalene	488	577	473	407	1,280
2-Methylnaphthalene	1,040	1,250	1,010	882	2,180
Naphthalene	1,850	2,090	1,790	1,540	790
<b>Total BTEXMN:</b>	<b>137,698</b>	<b>136,247</b>	<b>127,343</b>	<b>133,239</b>	<b>7,082</b>
C5-C6 Aliphatics	290,244	279,636	326,264	321,517	ND (<98)
>C6-C8 Aliphatics	306,346	299,689	306,375	302,334	1,394
>C8-C10 Aliphatics	62,223	73,371	65,545	58,444	31,323
>C10-C12 Aliphatics	19,957	22,982	19,589	16,759	106,607
>C12-C16 Aliphatics	4,534	4,866	3,888	3,627	267,393
>C16-C21 Aliphatics	ND (<3,130)	ND (<3,130)	ND (<3,210)	ND (<2,930)	218,956
>C21-C32 Aliphatics	ND (<3,130)	ND (<3,130)	ND (<3,210)	ND (<2,930)	44,075
>C8-C10 Aromatics	125,785	127,898	107,270	115,263	8,566
>C10-C12 Aromatics	45,876	47,500	37,705	42,075	39,878
>C12-C16 Aromatics	7,337	7,811	6,021	6,742	146,143
>C16-C21 Aromatics	ND (<3,130)	ND (<3,130)	ND (<3,210)	ND (<2,930)	108,788
>C21-C32 Aromatics	ND (<3,130)	ND (<3,130)	ND (<3,210)	ND (<2,930)	19,794
<b><sup>1</sup>Total Carbon Ranges:</b>	<b>862,302</b>	<b>863,753</b>	<b>872,657</b>	<b>866,761</b>	<b>992,918</b>
<b>Total BTEXMN + Carbon Ranges:</b>	<b>1,000,000</b>	<b>1,000,000</b>	<b>1,000,000</b>	<b>1,000,000</b>	<b>1,000,000</b>

**Notes**

1. Raw data noted in Table 1 adjusted in consultation with Newfields Environmental to generate a total hydrocarbon concentration of 1,000,000 mg/kg for each sample. BTEXMN data reported by laboratory assumed accurate. Unaccounted mass assumed to be related to error in reported concentration of carbon ranges. Relative proportion of carbon ranges assumed to be reasonably accurate. Individual carbon range data adjusted upwards based on the calculated "Percent Unaccounted Carbon Range Mass" (Unaccounted Mass/Total Carbon Ranges) to normalize data to 1,000,000 mg/kg (100%) total mass.

Table 2 (cont.). <sup>1</sup>Adjustment of fuel makeup data to account for unreported carbon range mass (refer to Table 1).

Analytes	ROAD DIESEL (mg/kg)	JP-5 (mg/kg)	JP-8 (mg/kg)	BUNKER C (mg/kg)	WASTE OIL (AUTO) (mg/kg)
Benzene	90	40	129	11	11
Toluene	674	252	3,070	8.3	248
Ethylbenzene	1,600	492	5,400	5.5	161
Xylenes	11,630	2,495	36,900	35	988
1-Methylnaphthalene	896	4,810	4,680	913	506
2-Methylnaphthalene	1,650	6,900	7,550	1,620	945
Naphthalene	560	3,490	4,050	1,120	386
<b>Total BTEXMN:</b>	<b>17,100</b>	<b>18,479</b>	<b>61,779</b>	<b>3,713</b>	<b>3,245</b>
C5-C6 Aliphatics	676	455	3,967	ND (<37)	148
>C6-C8 Aliphatics	5,390	3,769	35,926	ND (<37)	663
>C8-C10 Aliphatics	38,344	72,720	184,966	ND (<3,190)	ND (<2,950)
>C10-C12 Aliphatics	74,668	335,107	220,228	29,818	ND (<2,950)
>C12-C16 Aliphatics	239,609	379,670	286,465	107,040	2,445
>C16-C21 Aliphatics	259,981	2,724	25,382	143,402	12,661
>C21-C32 Aliphatics	42,921	ND (<1,650)	ND (<1,650)	383,455	875,929
>C8-C10 Aromatics	27,399	9,028	36,974	ND (<3,190)	2,922
>C10-C12 Aromatics	51,684	67,158	47,745	14,442	4,870
>C12-C16 Aromatics	134,481	108,851	89,492	63,205	6,671
>C16-C21 Aromatics	92,056	2,040	7,076	77,699	9,043
>C21-C32 Aromatics	15,692	ND (<1,650)	ND (<1,650)	177,227	81,403
<b><sup>1</sup>Total Carbon Ranges:</b>	<b>982,900</b>	<b>981,522</b>	<b>938,221</b>	<b>996,287</b>	<b>996,755</b>
<b>Total BTEXMN + Carbon Ranges:</b>	<b>1,000,000</b>	<b>1,000,000</b>	<b>1,000,000</b>	<b>1,000,000</b>	<b>1,000,000</b>

**Notes**

1. Raw data noted in Table 1 adjusted in consultation with Newfields Environmental to generate a total hydrocarbon concentration of 1,000,000 mg/kg for each sample. BTEXMN data reported by laboratory assumed accurate. Unaccounted mass assumed to be related to error in reported concentration of carbon ranges. Relative proportion of carbon ranges assumed to be reasonably accurate. Individual carbon range data adjusted upwards based on the calculated "Percent Unaccounted Carbon Range Mass" (Unaccounted Mass/Total Carbon Ranges) to normalize data to 1,000,000 mg/kg (100%) total mass.

Table 3. Default BTEXMN and carbon range makeup of petroleum fuels (refer to Table 2).

<b>Analytes</b>	<b><sup>1</sup>Gasoline</b>	<b><sup>2</sup>Diesel</b>	<b>Bunker C</b>
Benzene	0.90%	0.01%	0.00%
Toluene	4.9%	0.07%	0.00%
Ethylbenzene	1.1%	0.16%	0.00%
Xylenes	6.1%	1.2%	0.00%
1-Methylnapthalene	0.05%	0.09%	0.09%
2-Methylnapthalene	0.10%	0.17%	0.16%
Napthalene	0.18%	0.06%	0.11%
<b>Total BTEXMN:</b>	<b>13%</b>	<b>1.7%</b>	<b>0.37%</b>
C5-C6 Aliphatics	30%	0.07%	-
>C6-C8 Aliphatics	30%	0.54%	-
>C8-C10 Aliphatics	6.5%	3.8%	-
>C10-C12 Aliphatics	2.0%	7.5%	3.0%
>C12-C16 Aliphatics	0.42%	24%	11%
>C16-C21 Aliphatics	-	26%	14%
>C21-C32 Aliphatics	-	4.3%	38%
>C8-C10 Aromatics	12%	2.7%	-
>C10-C12 Aromatics	4.3%	5.2%	1.4%
>C12-C16 Aromatics	0.70%	13%	6.3%
>C16-C21 Aromatics	-	9.2%	7.8%
>C21-C32 Aromatics	-	1.6%	18%
<b><sup>1</sup>Total Carbon Ranges:</b>	<b>87%</b>	<b>98.3%</b>	<b>99.6%</b>
<b>Total BTEXMN + Carbon Ranges:</b>	<b>100%</b>	<b>100%</b>	<b>100%</b>

**Notes**

1. Average gasoline composition of types tested.
2. Diesel #1.

Table 4. Selected, default BTEXMN and toxicity-based, carbon range makeup of gasolines, diesel and Bunker C (refer to Table 3).

<b>Analytes</b>	<b><sup>1</sup>Gasolines</b>	<b><sup>2</sup>Middle Distillates</b>	<b><sup>3</sup>Residual Fuels</b>
Benzene	0.90%	0.01%	0.00%
Toluene	4.9%	0.07%	0.00%
Ethylbenzene	1.1%	0.16%	0.00%
Xylenes	6.1%	1.2%	0.00%
1-Methylnaphthalene	0.05%	0.09%	0.09%
2-Methylnaphthalene	0.10%	0.17%	0.16%
Naphthalene	0.18%	0.06%	0.11%
<b>Total BTEXMN:</b>	<b>13%</b>	<b>1.7%</b>	<b>0.37%</b>
C5-C8 Aliphatics	61%	0.61%	-
>C8-C18 Aliphatics	8.9%	61%	28%
>C18-C32 Aliphatics	-	4.3%	38%
>C8-C32 Aromatics	17%	32%	33%
<b><sup>1</sup>Total Carbon Ranges:</b>	<b>87%</b>	<b>98.3%</b>	<b>99.6%</b>
<b>Total BTEXMN + Carbon Ranges:</b>	<b>100%</b>	<b>100%</b>	<b>100%</b>

**Notes**

1. Based on average composition of gasolines.
2. Based on composition of diesel.
3. Based on composition of Bunker C.

Table 5. Default carbon range makeup of petroleum fuels used to develop TPH soil EALs for gasolines, middle distillates and residual fuels (refer to Table 4).

<b>Analytes</b>	<b>Gasolines</b>	<b>Middle Distillates</b>	<b>Residual Fuels</b>
C5-C8 Aliphatics	70%	0.62%	-
>C8-C18 Aliphatics	10%	62%	28%
>C18-C32 Aliphatics	-	4.4%	38%
>C8-C32 Aromatics	20%	33%	33%
<b>Total Carbon Ranges:</b>	<b>100%</b>	<b>100%</b>	<b>100%</b>

Table 6. Selected physiochemical constants and toxicity factors for BTEXMN and TPH carbon ranges.

<sup>1</sup> Chemical/ Carbon Range	Molecular Weight	<sup>2</sup> Vapor Pressure (mmHg)	Solubility in Water (µg/L)	Henry's Constant (unitless)	Partition Coeff, k <sub>oc</sub> (cm <sup>3</sup> /g)	Diffusion Coefficient (cm <sup>2</sup> /s)		
						air	water	
<b>Benzene</b>	78	95	1,790	0.23	146	0.09	1.0E-05	
<b>Toluene</b>	92	28	526	0.27	234	0.08	9.2E-06	
<b>Ethylbenzene</b>	106	9.6	169	0.32	446	0.07	8.5E-06	
<b>Xylenes (total)</b>	106	8.0	106	0.27	383	0.07	8.5E-06	
<b>Naphthalene</b>	128	0.085	31	0.018	1,544	0.06	8.4E-06	
<b>Volatile Carbon Ranges</b>	<b>C5-C8 Aliphatics</b>	93	76	11,000	54	2,265	0.08	1 x 10 <sup>-5</sup>
	<b>&gt;C8-C12 Aliphatics</b>	120	2.2	51,000	0.33	1,778	0.07	1 x 10 <sup>-5</sup>
	<b>C9-C10 Aromatics</b>	170	0.11	10	4,900	680,000	0.07	5 x 10 <sup>-6</sup>
<b>Nonvolatile Carbon Ranges</b>	<b>&gt;C12-C18 Aliphatics</b>	280	0.0008	0.0015	110	4.0 x 10 <sup>8</sup>	-	-
	<b>&gt;C18-C36 Aliphatics</b>	120	2.2	51,000	0.33	1,778	0.07	1 x 10 <sup>-5</sup>
	<b>&gt;C10-C22 Aromatics</b>	150	0.024	5,800	0.03	5,000	0.06	1 x 10 <sup>-5</sup>

**Notes**

1. BTEXMN constants from USEPA (2023). Solubility based on a temperature of 25°C. Carbon range constants from Massachusetts Department of Environmental Protection (MADEP 2002) except constants from C19-C36 aliphatics (Gustafson et al., 1997; based on EC>16-35 aliphatics in Table 7 of document).
2. Carbon range vapor pressures converted from atmospheres (1atm = 760 mmHg).



Table 7. <sup>1</sup>Toxicity factors selected for BTEXMN and targeted carbon ranges.

<b>Chemical/ Carbon Range</b>	<b>RfD<sub>Oral</sub> (mg/kg-day)</b>	<b>RfD<sub>Dermal</sub> (mg/kg-day)</b>	<b>RfC<sub>Inh</sub> (µg/m<sup>3</sup>)</b>
Benzene	0.004	0.004	0.03
Toluene	0.08	0.08	5
Ethylbenzene	0.1	0.1	1
Xylenes (total)	0.2	0.2	0.1
1-Methylnaphthalene	0.07	0.07	0.28
2-Methylnaphthalene	0.004	0.004	0.016
Naphthalene	0.02	0.02	0.003
C6-C8 aliphatics	0.005	0.005	400
C9-C18 aliphatics	0.01	0.01	100
C19+ aliphatics	3.0	3.0	nv
C9+ aromatics	0.01	0.01	60

**Notes**

1. Toxicity factors for BTEXMN from USEPA Regional Screening Level guidance (USEPA 2023). Toxicity factors for carbon ranges selected from USEPA PPRTV guidance (USEPA 2022).

# **GASOLINE**

Table A. Effective solubility and predicted relative makeup of dissolved-phase gasoline.

Chemical/ Carbon Range	<sup>1</sup> Molecular Weight	<sup>1</sup> Pure Component Solubility (mg/L)	<sup>2</sup> Weight % in Fuel	<sup>3</sup> Effective Solubility (mg/L)	<sup>4</sup> Predicted Relative BTEXMN + Carbon Range Makeup of Dissolved-Phase Hydrocarbons	<sup>5</sup> Predicted Relative Carbon Range Makeup of Dissolved-Phase Hydrocarbons	<sup>6</sup> Predicted Relative Carbon Range Makeup of Volatile Dissolved-Phase Hydrocarbons
Benzene	78	1790	0.90%	22	25%		
Toluene	92	526	4.9%	30	34%		
Ethylbenzene	106	169	1.1%	2.0	2.2%		
Xylenes	106	178	6.1%	11	12%		
1-Methylnaphthalene	142	25.8	0.05%	0.01	0.01%		
2-Methylnaphthalene	142	24.6	0.10%	0.02	0.02%		
Naphthalene	128	31	0.18%	0.05	0.05%		
C5-C6 Aliphatics	81	36	30%	15	16%	60%	60%
>C6-C8 Aliphatics	100	5.4	30%	1.8	2.0%	7.3%	7.3%
>C8-C10 Aliphatics	130	0.43	6.5%	0.02	0.03%	0.10%	0.10%
>C10-C12 Aliphatics	160	0.034	2.0%	0.000	0.001%	0.00%	0.00%
>C12-C16 Aliphatics	200	0.00076	0.42%	0.000002	0.000002%	0.00%	
>C16-C21 Aliphatics	270	0.0000025	-	-	-	-	
>C21-C32 Aliphatics	400	1.5E-11	-	-	-	-	
>C8-C10 Aromatics	120	65	12%	7.0	7.7%	29%	29%
>C10-C12 Aromatics	130	25	4.3%	0.9	1.0%	3.7%	3.7%
>C12-C16 Aromatics	150	5.8	0.70%	0.03	0.03%	0.12%	
>C16-C21 Aromatics	190	0.65	-	-	-	-	
>C21-C32 Aromatics	240	0.0066	-	-	-	0.00%	
<b>Sum BTEXMN:</b>			<b>13%</b>	<b>66</b>	<b>100%</b>	<b>100%</b>	<b>100%</b>
<b>Sum Carbon Ranges:</b>			<b>87%</b>	<b>24</b>			
<b>Sum BTEXMN + Carbon Ranges:</b>			<b>100%</b>	<b>90</b>			

**Table A (cont.). Effective solubility and predicted relative makeup of dissolved-phase gasoline.**

**Notes**

1. BTEXMN constants from USEPA (2023). Solubility based on a temperature of 25°C. Carbon range constants from Massachusetts Department of Environmental Protection (MADEP 2002) except constants from C19-C36 Aliphatics (Gustafson et al., 1997; based on EC>16-35 aliphatics in Table 7).
2. Based on average composition of gasolines reported by Newfields (2022).
3. Effective Solubility = Compound Solubility x [(Compound Weight % in Fuel x (Molecular Weight Fuel/Molecular Weight Compound)). Assumes average molecular weight for gasoline of 108 (ATSDR 1995).
4. Predicted makeup of dissolved-phase hydrocarbons = (Compound Effective Solubility/Sum Total Effective Solubilities).
5. Reflects predicted makeup of all dissolved-phase carbon ranges.
6. Reflects predicted makeup of volatile dissolved-phase carbon ranges.

Table B. <sup>1</sup>Predicted relative makeup of dissolved-phase gasoline in terms of toxicity-based carbon ranges.

Chemical/ Carbon Range	Relative Weight Percent Makeup of Neat Fuel	Predicted Makeup of Dissolved-Phase Hydrocarbons (mg/L)	Predicted Relative Makeup of Dissolved-Phase Hydrocarbons
<b>Total BTEXMN:</b>	13%	66	73%
<b>Total Carbon Ranges:</b>	87%	24	27%
<b>Benzene</b>	0.90%	22	25%
<b>Toluene</b>	4.9%	30	34%
<b>Ethylbenzene</b>	1.1%	2.0	2.2%
<b>Xylenes</b>	6.1%	11	12%
<b>1-Methylnaphthalene</b>	0.05%	0.01	0.01%
<b>2-Methylnaphthalene</b>	0.10%	0.02	0.02%
<b>Naphthalene</b>	0.18%	0.05	0.05%
<b>C5-C8 Aliphatics</b>	61%	16	18%
<b>&gt;C8-C18 Aliphatics</b>	8.9%	0.02	0.03%
<b>&gt;C18-C32 Aliphatics</b>	0.00%	0.00	0.00%
<b>&gt;C8 Aromatics</b>	17%	8	8.8%
<b>Sum:</b>	<b>100%</b>	<b>90</b>	<b>100%</b>

**Notes**

1. Refer to Table A.

Table C. Relative makeup of dissolved-phase gasoline with respect to specific media and exposure pathways.

Chemical/ Carbon Range	<sup>1</sup> Relative Carbon Range Makeup of Dissolved-Phase Hydrocarbons (ingestion)	<sup>2</sup> Relative Carbon Range Makeup of Dissolved-Phase Hydrocarbons (dermal)	<sup>3</sup> Relative Carbon Range Makeup of Volatile Dissolved-Phase Hydrocarbons (inhalation)	<sup>4</sup> Relative CR+BTEXMN Makeup of Dissolved-Phase Hydrocarbons (ingestion)	<sup>5</sup> Relative CR+BTEXMN Makeup of Dissolved-Phase Hydrocarbons (dermal)
<b>Total BTEXMN:</b>				73%	89%
<b>Total Carbon Ranges:</b>				27%	11%
<b>Benzene</b>				25%	30%
<b>Toluene</b>				34%	41%
<b>Ethylbenzene</b>				2.2%	2.6%
<b>Xylenes</b>				12%	15%
<b>1-Methylnaphthalene</b>				0.01%	0.01%
<b>2-Methylnaphthalene</b>				0.02%	0.03%
<b>Naphthalene</b>				0.05%	0.06%
<b>C5-C8 Aliphatics</b>	67%		68%	18%	
<b>&gt;C8-C18 Aliphatics</b>	0.10%		0.10%	0.03%	
<b>&gt;C18-C32 Aliphatics</b>	0.00%	0.00%		0.00%	0.00%
<b>&gt;C8 Aromatics</b>	32%	100%	32%	8.8%	11%
<b>Sum:</b>	<b>100%</b>	<b>100%</b>	<b>100%</b>	<b>100%</b>	<b>100%</b>

**Notes**

1. Relative makeup of dissolved-phase carbon ranges used for derivation of oral TPH toxicity factor for non-degraded TPH noted in Table E.
2. Relative makeup of dissolved-phase carbon ranges used to derive dermal uptake factor values in Table D and weighted dermal toxicity factor for non-degraded TPH noted in Table E (volatile aliphatic compounds excluded).
3. Relative makeup of dissolved-phase, volatile carbon range compounds used to derive weighted inhalation toxicity factor for non-degraded TPH noted in Table E.
4. Combined dissolved-phase carbon range and BTEXMN components used to derive weighted oral toxicity factor for degraded TPH noted in Table E.
5. Combined carbon range and BTEXMN components used to derive dermal uptake factor values in Table C and weighted dermal toxicity factor for degraded TPH noted in Table E.

Table D. Dermal absorption factors weighted for the default carbon range makeup of dissolved-phase gasoline.

<b>Chemical</b>	<b>B (unitless)</b>	<b><math>\tau_{event}</math> (hr/event)</b>	<b><math>t^*</math> (hr)</b>	<b>KP (cm/hr)</b>	<b>Basis</b>
Benzene	0.05	0.29	0.69	0.01	USEPA (2004, 2023) default benzene values
Toluene	0.11	0.35	0.83	0.03	USEPA (2004, 2023) default toluene values
Ethylbenzene	0.20	0.41	0.99	0.05	USEPA (2004, 2023) default ethylbenzene values
Xylenes (Total)	0.20	0.41	0.99	0.05	USEPA (2004, 2023) default naphthalene values
Naphthalene	0.20	0.55	1.3	0.05	USEPA (2004, 2023) default naphthalene values
1-Methylnaphthalene	0.43	0.66	1.6	0.09	USEPA (2004, 2023) default 1-methylnaphthalene values
C6-C8 Aliphatics	0.95	0.33	1.3	0.26	USEPA (2023) default Aliphatic Low values
>C8-C12 Aliphatics	7.4	0.55	2.5	1.70	USEPA (2023) default Aliphatic Medium values
>C12-C18 Aliphatics	7.4	0.55	2.5	1.70	USEPA (2023) default Aliphatic Medium values
>C18 Aliphatics	9.8	0.95	4.3	1.96	USEPA (2023) default Aliphatic High values
>C8-C12 Aromatics	0.334	0.495	1.189	0.079	USEPA (2023) default Aromatics Medium values
>C12-C22 Aromatics	0.334	0.495	1.189	0.079	USEPA (2023) default Aromatics Medium values
TPH (JP-5) Undegraded	0.334	0.495	1.189	0.079	<sup>1</sup> Calculated based on predicted carbon range makeup of dissolved-phase, undegraded TPH
TPH (JP-5) Degraded	0.093	0.346	0.830	0.026	<sup>1</sup> Calculated based on predicted carbon range + BTEXMN makeup of dissolved-phase, degraded TPH
TPH (JP-5) 50:50 Degradation	0.145	0.407	0.977	0.039	<sup>1</sup> Calculated based on 50:50 mixture of undegraded and degraded TPH

Notes:

1. Refer to Table B for a summary of the predicted carbon range and BTEXMN makeup of dissolved-phase TPH-related compounds in water that is in contact with fresh fuel.

Table E. Weighted toxicity factors calculated for TPH associated with neat and dissolved-phase gasoline.

Fuel Type	<sup>1</sup> Carbon Range Only (Fuel)		<sup>2</sup> Carbon Ranges Only (Dissolved)			<sup>3</sup> Carbon Ranges + BTEXMN		<sup>4</sup> 50:50 Mixture Degraded:Undegraded Plume		
	Oral/Dermal RfD (mg/kg-day)	Inhalation RfC (mg/m <sup>3</sup> )	Oral RfD (mg/kg-day)	Dermal RfD (mg/kg-day)	Inhalation RfC (mg/m <sup>3</sup> )	Oral RfD (mg/kg-day)	Dermal RfD (mg/kg-day)	Oral RfD (mg/kg-day)	Dermal RfD (mg/kg-day)	Inhalation RfC (mg/m <sup>3</sup> )
Gasoline	0.006	0.190	0.0060	0.010	0.140	0.009	0.011	0.007	0.010	0.140

**Notes**

1. Oral and dermal Reference Doses (RfDs) and inhalation Reference Concentration (RfC) weighted with respect to carbon range makeup for gasolines (excludes BTEXMN). Based on relative carbon range makeup of fuel and fuel vapors (refer to Table 1 and Section 6 of Appendix 1).
2. Oral and dermal Reference Doses (RfDs) and inhalation Reference Concentration (RfC) weighted with respect to dissolved-phase carbon range makeup of gasoline in water (refer to Table C; excludes BTEXMN). Undegraded BTEXMN assessed separately. Considers ingestion of drinking water, inhalation of vapors during water use and dermal contact during bathing. Volatile aliphatic compounds assumed lost during water use and not considered for dermal contact.
3. Oral and dermal Reference Doses (RfDs) for dissolved carbon ranges plus BTEXMN weighted with respect to makeup noted in Table C. Intended to reflect toxicity of partially oxidized and non-volatile hydrocarbons in water. Considers ingestion of drinking water and dermal contact during bathing. Degraded compounds assumed to not be significantly volatile and not available for exposure via inhalation. Degraded aliphatic compounds assumed to remain in water and be available for dermal absorption during bathing.
4. Oral and dermal Reference Doses (RfDs) and inhalation Reference Concentration (RfC) weighted with respect to 50:50 mixture of undegraded carbon ranges and degraded mixture of nonvolatile carbon range plus BTEXMN. Includes consideration of ingestion of drinking water, inhalation of vapors during water use and dermal contact during bathing.



# Diesel

Table A. Effective solubility and predicted relative makeup of dissolved-phase diesel.

Chemical/ Carbon Range	<sup>1</sup> Molecular Weight	<sup>1</sup> Pure Component Solubility (mg/L)	<sup>2</sup> Weight % in Fuel	<sup>3</sup> Effective Solubility (mg/L)	<sup>4</sup> Predicted Relative BTEXMN + Carbon Range Makeup of Dissolved-Phase Hydrocarbons	<sup>5</sup> Predicted Relative Carbon Range Makeup of Dissolved-Phase Hydrocarbons	<sup>6</sup> Predicted Relative Carbon Range Makeup of Volatile Dissolved-Phase Hydrocarbons
Benzene	78	1790	0.01%	0.41	3.5%		
Toluene	92	526	0.07%	0.76	6.5%		
Ethylbenzene	106	169	0.16%	0.51	4.3%		
Xylenes	106	178	1.16%	3.87	33%		
1-Methylnaphthalene	142	25.8	0.09%	0.03	0.27%		
2-Methylnaphthalene	142	24.6	0.17%	0.06	0.48%		
Naphthalene	128	31	0.06%	0.03	0.23%		
C5-C6 Aliphatics	81	36	0.07%	0.06	0.50%	0.97%	1.2%
>C6-C8 Aliphatics	100	5.4	0.54%	0.1	0.49%	0.94%	1.1%
>C8-C10 Aliphatics	130	0.43	3.8%	0.03	0.21%	0.41%	0.50%
>C10-C12 Aliphatics	160	0.034	7.5%	0.003	0.03%	0.05%	0.06%
>C12-C16 Aliphatics	200	0.00076	24%	0.0002	0.002%	0.003%	0.00%
>C16-C21 Aliphatics	270	0.0000025	26%	0.000000	0.000004%	0.00%	
>C21-C32 Aliphatics	400	1.5E-11	4.29%	3.2E-13	-	0.00%	
>C8-C10 Aromatics	120	65	2.7%	2.9	25%	48%	58%
>C10-C12 Aromatics	130	25	5.2%	2.0	17%	32%	39%
>C12-C16 Aromatics	150	5.8	13%	1.03	8.7%	17%	
>C16-C21 Aromatics	190	0.65	9.2%	0.06	0.53%	1.0%	
>C21-C32 Aromatics	240	0.0066	1.6%	0.0E+00	-	0.00%	
<b>Sum BTEXMN:</b>			<b>1.7%</b>	<b>5.7</b>	<b>100%</b>	<b>100%</b>	<b>100%</b>
<b>Sum Carbon Ranges:</b>			<b>98%</b>	<b>6.1</b>			
<b>Sum BTEXMN + Carbon Ranges:</b>			<b>100%</b>	<b>12</b>			

Table A (cont.). Effective solubility and predicted relative makeup of dissolved-phase diesel.

**Notes**

1. BTEXMN constants from USEPA (2023). Solubility based on a temperature of 25°C. Carbon range constants from Massachusetts Department of Environmental Protection (MADEP 2002) except constants from C19-C36 Aliphatics (Gustafson et al., 1997; based on EC>16-35 aliphatics in Table 7).
2. Based on average composition of gasolines reported by Newfields (2022).
3. Effective Solubility = Compound Solubility x [(Compound Weight % in Fuel x (Molecular Weight Fuel/Molecular Weight Compound)). Assumes average molecular weight for diesel of 201 (NRC 1996).
4. Predicted makeup of dissolved-phase hydrocarbons = (Compound Effective Solubility/Sum Total Effective Solubilities).
5. Reflects predicted makeup of all dissolved-phase carbon ranges.
6. Reflects predicted makeup of volatile dissolved-phase carbon ranges.

Table B. <sup>1</sup>Predicted relative makeup of dissolved-phase diesel in terms of toxicity-based carbon ranges.

<b>Chemical/ Carbon Range</b>	<b>Relative Weight Percent Makeup of Neat Fuel</b>	<b>Predicted Makeup of Dissolved-Phase Hydrocarbons (mg/L)</b>	<b>Predicted Relative Makeup of Dissolved-Phase Hydrocarbons</b>
<b>Total BTEXMN:</b>	1.7%	5.7	48%
<b>Total Carbon Ranges:</b>	98%	6.1	52%
<b>Benzene</b>	0.01%	0.41	3.5%
<b>Toluene</b>	0.07%	0.76	6.5%
<b>Ethylbenzene</b>	0.16%	0.51	4.28%
<b>Xylenes</b>	1.2%	3.9	33%
<b>1-Methylnaphthalene</b>	0.09%	0.03	0.3%
<b>2-Methylnaphthalene</b>	0.17%	0.06	0.48%
<b>Naphthalene</b>	0.06%	0.03	0.2%
<b>C5-C8 Aliphatics</b>	0.61%	0.12	1.0%
<b>&gt;C8-C18 Aliphatics</b>	61%	0.03	0.24%
<b>&gt;C18-C32 Aliphatics</b>	4.3%	0.00	0.00%
<b>&gt;C8 Aromatics</b>	32%	6.0	51%
<b>Sum:</b>	<b>100%</b>	<b>12</b>	<b>100%</b>

**Notes**

1. Refer to Table A.

Table C. Relative makeup of dissolved-phase diesel with respect to specific media and exposure pathways.

Chemical/ Carbon Range	<sup>1</sup> Relative Carbon Range Makeup of Dissolved-Phase Hydrocarbons (ingestion)	<sup>2</sup> Relative Carbon Range Makeup of Dissolved-Phase Hydrocarbons (dermal)	<sup>3</sup> Relative Carbon Range Makeup of Volatile Dissolved-Phase Hydrocarbons (inhalation)	<sup>4</sup> Relative CR+BTEXMN Makeup of Dissolved-Phase Hydrocarbons (ingestion)	<sup>5</sup> Relative CR+BTEXMN Makeup of Dissolved-Phase Hydrocarbons (dermal)
<b>Total BTEXMN:</b>				48%	49%
<b>Total Carbon Ranges:</b>				52%	51%
<b>Benzene</b>				3.5%	3.5%
<b>Toluene</b>				6.5%	6.5%
<b>Ethylbenzene</b>				4.3%	4.3%
<b>Xylenes</b>				33%	33%
<b>1-Methylnaphthalene</b>				0.27%	0.28%
<b>2-Methylnaphthalene</b>				0.48%	0.49%
<b>Naphthalene</b>				0.23%	0.23%
<b>C5-C8 Aliphatics</b>	1.9%		2.3%	1.0%	
<b>&gt;C8-C18 Aliphatics</b>	0.46%		0.56%	0.24%	
<b>&gt;C18-C32 Aliphatics</b>	0.00%	0.00%		0.00%	0.00%
<b>&gt;C8 Aromatics</b>	98%	100%	97%	51%	51%
<b>Sum:</b>	<b>100%</b>	<b>100%</b>	<b>100%</b>	<b>100%</b>	<b>100%</b>

**Notes**

1. Relative makeup of dissolved-phase carbon ranges used for derivation of oral TPH toxicity factor for non-degraded TPH noted in Table E.
2. Relative makeup of dissolved-phase carbon ranges used to derive dermal uptake factor values in Table D and weighted dermal toxicity factor for non-degraded TPH noted in Table E (volatile aliphatic compounds excluded).
3. Relative makeup of dissolved-phase, volatile carbon range compounds used to derive weighted inhalation toxicity factor for non-degraded TPH noted in Table E.
4. Combined dissolved-phase carbon range and BTEXMN components used to derive weighted oral toxicity factor for degraded TPH noted in Table E.
5. Combined carbon range and BTEXMN components used to derive dermal uptake factor values in Table C and weighted dermal toxicity factor for degraded TPH noted in Table E.

Table D. Dermal absorption factors weighted for the default carbon range makeup of dissolved-phase diesel.

<b>Chemical</b>	<b>B (unitless)</b>	<b><math>\tau_{event}</math> (hr/event)</b>	<b><math>t^*</math> (hr)</b>	<b>KP (cm/hr)</b>	<b>Basis</b>
Benzene	0.05	0.29	0.69	0.01	USEPA (2004, 2023) default benzene values
Toluene	0.11	0.35	0.83	0.03	USEPA (2004, 2023) default toluene values
Ethylbenzene	0.20	0.41	0.99	0.05	USEPA (2004, 2023) default ethylbenzene values
Xylenes (Total)	0.20	0.41	0.99	0.05	USEPA (2004, 2023) default naphthalene values
Naphthalene	0.20	0.55	1.3	0.05	USEPA (2004, 2023) default naphthalene values
1-Methylnaphthalene	0.43	0.66	1.6	0.09	USEPA (2004, 2023) default 1-methylnaphthalene values
C6-C8 Aliphatics	0.95	0.33	1.3	0.26	USEPA (2023) default Aliphatic Low values
>C8-C12 Aliphatics	7.4	0.55	2.5	1.70	USEPA (2023) default Aliphatic Medium values
>C12-C18 Aliphatics	7.4	0.55	2.5	1.70	USEPA (2023) default Aliphatic Medium values
>C18 Aliphatics	9.8	0.95	4.3	1.96	USEPA (2023) default Aliphatic High values
>C8-C12 Aromatics	0.334	0.495	1.189	0.079	USEPA (2023) default Aromatics Medium values
>C12-C22 Aromatics	0.334	0.495	1.189	0.079	USEPA (2023) default Aromatics Medium values
TPH (diesel) Undegraded	0.334	0.495	0.495	0.495	<sup>1</sup> Calculated based on predicted carbon range makeup of dissolved-phase, undegraded TPH
TPH (diesel) Degraded	0.212	0.440	1.057	0.054	<sup>1</sup> Calculated based on predicted carbon range + BTEXMN makeup of dissolved-phase, degraded TPH
TPH (diesel) 50:50 Degradation	0.259	0.466	0.675	0.097	<sup>1</sup> Calculated based on 50:50 mixture of undegraded and degraded TPH

Notes:

1. Refer to Table B for a summary of the predicted carbon range and BTEXMN makeup of dissolved-phase TPH-related compounds in water that is in contact with fresh fuel.

Table E. Weighted toxicity factors calculated for TPH associated with neat and dissolved-phase diesel.

Fuel Type	<sup>1</sup> Carbon Range Only (Fuel)		<sup>2</sup> Carbon Ranges Only (Dissolved)			<sup>3</sup> Carbon Ranges + BTEXMN		<sup>4</sup> 50:50 Mixture Degraded:Undegraded Plume		
	Oral/Dermal RfD (mg/kg-day)	Inhalation RfC (mg/m <sup>3</sup> )	Oral RfD (mg/kg-day)	Dermal RfD (mg/kg-day)	Inhalation RfC (mg/m <sup>3</sup> )	Oral RfD (mg/kg-day)	Dermal RfD (mg/kg-day)	Oral RfD (mg/kg-day)	Dermal RfD (mg/kg-day)	Inhalation RfC (mg/m <sup>3</sup> )
Diesel	0.010	0.123	0.010	0.010	0.061	0.015	0.015	0.012	0.012	0.061

**Notes**

1. Oral and dermal Reference Doses (RfDs) and inhalation Reference Concentration (RfC) weighted with respect to carbon range makeup for diesel (excludes BTEXMN). Based on relative carbon range makeup of fuel and fuel vapors(refer to Table 1 and Section 6 of Appendix 1).
2. Oral and dermal Reference Doses (RfDs) and inhalation Reference Concentration (RfC) weighted with respect to dissolved-phase carbon range makeup of diesel in water (refer to Table C; excludes BTEXMN). Undegraded BTEXMN assessed separately. Considers ingestion of drinking water, inhalation of vapors during water use and dermal contact during bathing. Volatile aliphatic compounds assumed lost during water use and not considered for dermal contact.
3. Oral and dermal Reference Doses (RfDs) for dissolved carbon ranges plus BTEXMN weighted with respect to makeup noted in Table C. Intended to reflect toxicity of partially oxidized and non-volatile hydrocarbons in water. Considers ingestion of drinking water and dermal contact during bathing. Degraded compounds assumed to not be significantly volatile and not available for exposure via inhalation. Degraded aliphatic compounds assumed to remain in water and be available for dermal absorption during bathing.
4. Oral and dermal Reference Doses (RfDs) and inhalation Reference Concentration (RfC) weighted with respect to 50:50 mixture of undegraded carbon ranges and degraded mixture of nonvolatile carbon range plus BTEXMN. Includes consideration of ingestion of drinking water, inhalation of vapors during water use and dermal contact during bathing.

# Bunker C



Table A. Effective solubility and predicted relative makeup of dissolved-phase Bunker C.

Chemical/ Carbon Range	<sup>1</sup> Molecular Weight	<sup>1</sup> Pure Component Solubility (mg/L)	<sup>2</sup> Weight % in Fuel	<sup>3</sup> Effective Solubility (mg/L)	<sup>4</sup> Predicted Relative BTEXMN + Carbon Range Makeup of Dissolved-Phase Hydrocarbons	<sup>5</sup> Predicted Relative Carbon Range Makeup of Dissolved-Phase Hydrocarbons	<sup>6</sup> Predicted Relative Carbon Range Makeup of Volatile Dissolved-Phase Hydrocarbons
Benzene	78	1790	0.001%	0.17	3.9%		
Toluene	92	526	0.001%	0.03	0.72%		
Ethylbenzene	106	169	0.001%	0.01	0.13%		
Xylenes	106	178	0.004%	0.04	0.90%		
1-Methylnaphthalene	142	25.8	0.09%	0.11	2.5%		
2-Methylnaphthalene	142	24.6	0.16%	0.18	4.3%		
Naphthalene	128	31	0.11%	0.18	4.1%		
C5-C6 Aliphatics	81	36	-	-	-		
>C6-C8 Aliphatics	100	5.4	-	-	-		
>C8-C10 Aliphatics	130	0.43	-	-	-		
>C10-C12 Aliphatics	160	0.034	3.0%	0.004	0.10%	0.12%	0.23%
>C12-C16 Aliphatics	200	0.00076	11%	0.0003	0.006%	0.01%	
>C16-C21 Aliphatics	270	0.0000025	14%	0.0	0.00002%	0.00%	
>C21-C32 Aliphatics	400	1.5E-11	38%	9.3E-12	0.0000000002%	0.00%	
>C8-C10 Aromatics	120	65	-	-	-		0.00%
>C10-C12 Aromatics	130	25	1.4%	1.8	42%	51%	99.8%
>C12-C16 Aromatics	150	5.8	6.3%	1.59	37%	44%	
>C16-C21 Aromatics	190	0.65	7.8%	0.2	4.0%	4.8%	
>C21-C32 Aromatics	240	0.0066	18%	-	-	0.09%	
<b>Sum BTEXMN:</b>			<b>0.37%</b>	<b>0.71</b>	<b>100%</b>	<b>100%</b>	<b>100%</b>
<b>Sum Carbon Ranges:</b>			<b>100%</b>	<b>3.6</b>			
<b>Sum BTEXMN + Carbon Ranges:</b>			<b>100%</b>	<b>4.3</b>			

Table A (cont.). Effective solubility and predicted relative makeup of dissolved-phase Bunker C.

**Notes**

1. BTEXMN constants from USEPA (2023). Solubility based on a temperature of 25°C. Carbon range constants from Massachusetts Department of Environmental Protection (MADEP 2002) except constants from C19-C36 Aliphatics (Gustafson et al., 1997; based on EC>16-35 aliphatics in Table 7).
2. Based on average composition of gasolines reported by Newfields (2022).
3. Effective Solubility = Compound Solubility x [(Compound Weight % in Fuel x (Molecular Weight Fuel/Molecular Weight Compound)). Assumes average molecular weight for Bunker C of 600 (IARC 1989, CountryMark 2021).
4. Predicted makeup of dissolved-phase hydrocarbons = (Compound Effective Solubility/Sum Total Effective Solubilities).
5. Reflects predicted makeup of all dissolved-phase carbon ranges.
6. Reflects predicted makeup of volatile dissolved-phase carbon ranges.

Table B. <sup>1</sup>Predicted relative makeup of dissolved-phase Bunker C in terms of toxicity-based carbon ranges.

<b>Chemical/ Carbon Range</b>	<b>Relative Weight Percent Makeup of Neat Fuel</b>	<b>Predicted Makeup of Dissolved-Phase Hydrocarbons (mg/L)</b>	<b>Predicted Relative Makeup of Dissolved-Phase Hydrocarbons</b>
<b>Total BTEXMN:</b>	0.37%	0.71	17%
<b>Total Carbon Ranges:</b>	99.63%	3.6	83%
<b>Benzene</b>	0.00%	0.17	3.9%
<b>Toluene</b>	0.00%	0.03	0.72%
<b>Ethylbenzene</b>	0.00%	0.01	0.13%
<b>Xylenes</b>	0.00%	0.04	1%
<b>1-Methylnaphthalene</b>	0.09%	0.11	2.5%
<b>2-Methylnaphthalene</b>	0.16%	0.18	4.3%
<b>Naphthalene</b>	0.11%	0.18	4.1%
<b>C5-C8 Aliphatics</b>	0.00%	0.00	0.00%
<b>&gt;C8-C18 Aliphatics</b>	28%	0.00	0.00%
<b>&gt;C18-C32 Aliphatics</b>	38%	0.00	0.00%
<b>&gt;C8 Aromatics</b>	33%	3.6	83%
<b>Sum:</b>	<b>100%</b>	<b>4.3</b>	<b>100%</b>

**Notes**

1. Refer to Table A.

Table C. Relative makeup of dissolved-phase Bunker C with respect to specific media and exposure pathways.

<b>Chemical/ Carbon Range</b>	<b><sup>1</sup>Relative Carbon Range Makeup of Dissolved- Phase Hydrocarbons (ingestion)</b>	<b><sup>2</sup>Relative Carbon Range Makeup of Dissolved- Phase Hydrocarbons (dermal)</b>	<b><sup>3</sup>Relative Carbon Range Makeup of Volatile Dissolved-Phase Hydrocarbons (inhalation)</b>	<b><sup>4</sup>Relative CR+BTEXMN Makeup of Dissolved-Phase Hydrocarbons (ingestion)</b>	<b><sup>5</sup>Relative CR+BTEXMN Makeup of Dissolved-Phase Hydrocarbons (dermal)</b>
<b>Total BTEXMN:</b>				17%	17%
<b>Total Carbon Ranges:</b>				83%	83%
<b>Benzene</b>				3.9%	3.9%
<b>Toluene</b>				0.72%	0.72%
<b>Ethylbenzene</b>				0.13%	0.13%
<b>Xylenes</b>				0.90%	0.90%
<b>1-Methylnaphthalene</b>				2.5%	2.5%
<b>2-Methylnaphthalene</b>				4.3%	4.3%
<b>Naphthalene</b>				4.1%	4.1%
<b>C5-C8 Aliphatics</b>	0.00%		0.00%	0.00%	
<b>&gt;C8-C18 Aliphatics</b>	0.12%		0.23%	0.10%	
<b>&gt;C18-C32 Aliphatics</b>	0.00%	0.0%		0.00%	0.00%
<b>&gt;C8 Aromatics</b>	99.88%	100%	100%	83%	83%
<b>Sum:</b>	<b>100%</b>	<b>100%</b>	<b>100%</b>	<b>100%</b>	<b>100%</b>

**Notes**

1. Relative makeup of dissolved-phase carbon ranges used for derivation of oral TPH toxicity factor for non-degraded TPH noted in Table E.
2. Relative makeup of dissolved-phase carbon ranges used to derive dermal uptake factor values in Table D and weighted dermal toxicity factor for non-degraded TPH noted in Table E (volatile aliphatic compounds excluded).
3. Relative makeup of dissolved-phase, volatile carbon range compounds used to derive weighted inhalation toxicity factor for non-degraded TPH noted in Table E.
4. Combined dissolved-phase carbon range and BTEXMN components used to derive weighted oral toxicity factor for degraded TPH noted in Table E.
5. Combined carbon range and BTEXMN components used to derive dermal uptake factor values in Table C and weighted dermal toxicity factor for degraded TPH noted in Table E.

Table D. Dermal absorption factors weighted for the default carbon range makeup of dissolved-phase Bunker C.

<b>Chemical</b>	<b>B (unitless)</b>	<b><math>\tau_{event}</math> (hr/event)</b>	<b><math>t^*</math> (hr)</b>	<b>KP (cm/hr)</b>	<b>Basis</b>
Benzene	0.05	0.29	0.69	0.01	USEPA (2004, 2023) default benzene values
Toluene	0.11	0.35	0.83	0.03	USEPA (2004, 2023) default toluene values
Ethylbenzene	0.20	0.41	0.99	0.05	USEPA (2004, 2023) default ethylbenzene values
Xylenes (Total)	0.20	0.41	0.99	0.05	USEPA (2004, 2023) default naphthalene values
Naphthalene	0.20	0.55	1.3	0.05	USEPA (2004, 2023) default naphthalene values
1-Methylnaphthalene	0.43	0.66	1.6	0.09	USEPA (2004, 2023) default 1-methylnaphthalene values
C6-C8 Aliphatics	0.95	0.33	1.3	0.26	USEPA (2023) default Aliphatic Low values
>C8-C12 Aliphatics	7.4	0.55	2.5	1.70	USEPA (2023) default Aliphatic Medium values
>C12-C18 Aliphatics	7.4	0.55	2.5	1.70	USEPA (2023) default Aliphatic Medium values
>C18 Aliphatics	9.8	0.95	4.3	1.96	USEPA (2023) default Aliphatic High values
>C8-C12 Aromatics	0.334	0.495	1.189	0.079	USEPA (2023) default Aromatics Medium values
>C12-C22 Aromatics	0.334	0.495	1.189	0.079	USEPA (2023) default Aromatics Medium values
TPH (Bunker C) Undegraded	0.334	0.495	1.189	0.079	<sup>1</sup> Calculated based on predicted carbon range makeup of dissolved-phase, undegraded TPH
TPH (Bunker C) Degraded	0.267	0.490	1.175	0.066	<sup>1</sup> Calculated based on predicted carbon range + BTEXMN makeup of dissolved-phase, degraded TPH
TPH (Bunker C) 50:50 Degradation	0.297	0.493	1.182	0.072	<sup>1</sup> Calculated based on 50:50 mixture of undegraded and degraded TPH

Notes:

1. Refer to Table B for a summary of the predicted carbon range and BTEXMN makeup of dissolved-phase TPH-related compounds in water that is in contact with fresh fuel.

Table E. Weighted toxicity factors calculated for TPH associated with neat and dissolved-phase Bunker C.

Fuel Type	<sup>1</sup> Carbon Range Only (Fuel)		<sup>2</sup> Carbon Ranges Only (Dissolved)			<sup>3</sup> Carbon Ranges + BTEXMN		<sup>4</sup> 50:50 Mixture Degraded:Undegraded Plume		
	Oral/Dermal RfD (mg/kg-day)	Inhalation RfC (mg/m <sup>3</sup> )	Oral RfD (mg/kg-day)	Dermal RfD (mg/kg-day)	Inhalation RfC (mg/m <sup>3</sup> )	Oral RfD (mg/kg-day)	Dermal RfD (mg/kg-day)	Oral RfD (mg/kg-day)	Dermal RfD (mg/kg-day)	Inhalation RfC (mg/m <sup>3</sup> )
Bunker C	0.016	0.123	0.0100	0.0100	0.0601	0.0094	0.0094	0.0097	0.0097	0.0601

**Notes**

1. Oral and dermal Reference Doses (RfDs) weighted with respect to carbon range makeup for Bunker C (excludes BTEXMN). Based on relative carbon range makeup of fuel and fuel vapors(refer to Table 1 and Section 6 of Appendix 1). Inhalation Reference Concentration (RfC) assumed identical to diesel vapors.
2. Oral and dermal Reference Doses (RfDs) and inhalation Reference Concentration (RfC) weighted with respect to dissolved-phase carbon range makeup of Bunker C in water (refer to Table C; excludes BTEXMN). Undegraded BTEXMN assessed separately. Considers ingestion of drinking water, inhalation of vapors during water use and dermal contact during bathing. Volatile aliphatic compounds assumed lost during water use and not considered for dermal contact.
3. Oral and dermal Reference Doses (RfDs) for dissolved carbon ranges plus BTEXMN weighted with respect to makeup noted in Table C. Intended to reflect toxicity of partially oxidized and non-volatile hydrocarbons in water. Considers ingestion of drinking water and dermal contact during bathing. Degraded compounds assumed to not be significantly volatile and not available for exposure via inhalation. Degraded aliphatic compounds assumed to remain in water and be available for dermal absorption during bathing.
4. Oral and dermal Reference Doses (RfDs) and inhalation Reference Concentration (RfC) weighted with respect to 50:50 mixture of undegraded carbon ranges and degraded mixture of nonvolatile carbon range plus BTEXMN. Includes consideration of ingestion of drinking water, inhalation of vapors during water use and dermal contact during bathing.



October 28<sup>th</sup>, 2022

Roger Brewer  
Hawaii Department of Health  
919 Ala Moana Boulevard  
Honolulu, HI 96813

Cc: Eric M. Jensen  
Tetra Tech, Inc.  
Honolulu, HI 96813

Dr. Brewer,

This memo provides supplemental analytical data in support of the fuel study conducted by Alpha Analytical and NewFields Environmental Forensics on behalf of the Hawaii Department of Health. The fuel variants considered in this study were obtained from NewFields' forensic reference material library. More information on the reference fuels can be provided upon request. This study included the analysis of the following fuel variants:

Fuel Category	Fuel Variant
Gasolines	E10 87 Octane E10 91 Octane E10 93 Octane
Middle Distillates	Heating Fuel Road Diesel JP-5 JP-8
Residual Fuels	Waste Oil (auto) Bunker C

Alpha Analytical tested the fuel samples for volatile petroleum hydrocarbons (VPH) by Massachusetts Department of Environmental Protection (MADEP) VPH Method 2.1, and volatile paraffins, isoparaffins, aromatics, naphthenes and olefins (PIANO) by a modification of EPA Method 8260D. Using open column chromatography, the fuel samples were separated into aliphatic (F1), and aromatic (F2) fractions. The aliphatic, aromatic, and the whole extracts were then analyzed for total petroleum hydrocarbons (TPH C<sub>9</sub>-C<sub>44</sub>) by EPA Method 8015D. The Alpha data can be found attached to this report. Newfields, using Agilent's EnviroQuant™ data processing software further analyzed the VPH (C<sub>5</sub>-C<sub>8</sub>), and TPH (C<sub>8</sub>-C<sub>32</sub>) raw data to generate concentrations for the following carbon ranges from the aliphatic, aromatic and combined extracts:

Carbon Range		
C5-C6 Aliphatics	>C8-C10 Aromatics	>C8-C10 Combined
>C6-C8 Aliphatics	>C10-C12 Aromatics	>C10-C12 Combined
>C8-C10 Aliphatics	>C12-C16 Aromatics	>C12-C16 Combined
>C10-C12 Aliphatics	>C16-C21 Aromatics	>C16-C21 Combined
>C12-C16 Aliphatics	>C21-C32 Aromatics	>C21-C32 Combined
>C16-C21 Aliphatics		
>C21-C32 Aliphatics		

This report includes carbon range concentrations (mg/kg<sub>oil</sub>), flame ionization detector (FID) chromatograms (aliphatic, aromatic, and combined extracts), and the detailed raw data quantitation reports that record the integration of each carbon range. I am available to discuss this data further at your convenience.

Sincerely,

A handwritten signature in black ink, appearing to read "Eric Litman".

Eric Litman, M.S.  
Senior Consultant  
NewFields Environmental Forensics

Attached:

- Attachment A: Carbon Range Data Report
- Attachment B: FID Chromatograms - Whole Extract
- Attachment C: FID Chromatograms Aliphatic Fraction
- Attachment D: FID Chromatograms Aromatic Fraction
- Attachment E: FID Chromatograms VPH
- Attachment F: Quantitation Raw Data Reports
- Attachment G: Alpha Analytical Data Package L2240634



## Attachment A: Carbon Range Data Report

Project Name: Hawaii DOH - Fuel Study

	Duplicate			
Client ID	GASOLINE 87	GASOLINE 87	GASOLINE 91	GASOLINE 93
Matrix	OIL	OIL	OIL	OIL
Reference Method	VPH/8015D(M)	VPH/8015D(M)	VPH/8015D(M)	VPH/8015D(M)
Batch ID	WG1676301	WG1676301	WG1676301	WG1676301
Date Collected	7/26/2022	7/26/2022	7/26/2022	7/26/2022
Date Received	7/29/2022	7/29/2022	7/29/2022	7/29/2022
Date Prepped	8/17/2022	8/17/2022	8/17/2022	8/17/2022
Date Analyzed	8/18/2022	8/18/2022	8/18/2022	8/18/2022
Sample Size(wet)	0.1054	0.1054	0.1027	0.1125
% Solid	100	100	100	100
File ID	f1708172220	f1708172220	f1708172224	f1708172226
Lab ID Combined:	L2240634-01	WG1676301-4	L2240634-04	L2240634-07
Lab ID F1:	L2240634-02	WG1676456-4	L2240634-05	L2240634-08
Lab ID F2:	L2240634-03	WG1676458-4	L2240634-06	L2240634-09
Units	mg/kg	mg/kg	mg/kg	mg/kg

Fraction	Analytes	Result	Q	RL	Result	Q	RL	Result	Q	RL	Result	Q	RL
Aliphatic	C5-C6 Aliphatics	23,395		22,500	23,910		22,500	23,948		21,900	16,578	J	21,400
Aliphatic	>C6-C8 Aliphatics	40,765		22,500	35,492		22,500	34,839		21,900	22,557		21,400
Aliphatic	>C8-C10 Aliphatics	36,595		3,130	42,871		3,130	38,359		3,210	33,345		2,930
Aliphatic	>C10-C12 Aliphatics	11,737		3,130	13,428		3,130	11,464		3,210	9,562		2,930
Aliphatic	>C12-C16 Aliphatics	2,667	J	3,130	2,843	J	3,130	2,275	J	3,210	2,069	J	2,930
Aliphatic	>C16-C21 Aliphatics		U	3,130		U	3,130		U	3,210		U	2,930
Aliphatic	>C21-C32 Aliphatics		U	3,130		U	3,130		U	3,210		U	2,930
Aromatic	>C8-C10 Aromatics	73,977		3,130	74,732		3,130	62,778		3,210	65,763		2,930
Aromatic	>C10-C12 Aromatics	26,981		3,130	27,755		3,130	22,066		3,210	24,006		2,930
Aromatic	>C12-C16 Aromatics	4,315		3,130	4,564		3,130	3,524		3,210	3,847		2,930
Aromatic	>C16-C21 Aromatics		U	3,130		U	3,130		U	3,210		U	2,930
Aromatic	>C21-C32 Aromatics		U	3,130		U	3,130		U	3,210		U	2,930
Combined	>C8-C10 Combined	182,369		6,260	173,957		6,260	163,348		6,430	163,372		5,870
Combined	>C10-C12 Combined	56,742		6,260	53,742		6,260	46,601		6,430	47,722		5,870
Combined	>C12-C16 Combined	10,283		6,260	9,868		6,260	8,099		6,430	8,118		5,870
Combined	>C16-C21 Combined		U	6,260		U	6,260		U	6,430		U	5,870
Combined	>C21-C32 Combined		U	6,260		U	6,260		U	6,430		U	5,870

Project Name: Hawaii DOH - Fi

Client ID	HEATING FUEL	ROAD DIESEL	JP-5	JP-8
Matrix	OIL	OIL	OIL	OIL
Reference Method	VPH/8015D(M)	VPH/8015D(M)	VPH/8015D(M)	VPH/8015D(M)
Batch ID	WG1676301	WG1676301	WG1676301	WG1676301
Date Collected	7/26/2022	7/26/2022	7/26/2022	7/26/2022
Date Received	7/29/2022	7/29/2022	7/29/2022	7/29/2022
Date Prepped	8/17/2022	8/17/2022	8/17/2022	8/17/2022
Date Analyzed	8/18/2022	8/18/2022	8/18/2022	8/18/2022
Sample Size(wet)	0.1122	0.1118	0.02	0.02
% Solid	100	100	100	100
File ID	f1708172228	f1708172230	f1708172232	f1708172240
Lab ID Combined:	L2240634-10	L2240634-13	L2240634-16	L2240634-19
Lab ID F1:	L2240634-11	L2240634-14	L2240634-17	L2240634-20
Lab ID F2:	L2240634-12	L2240634-15	L2240634-18	L2240634-21
Units	mg/kg	mg/kg	mg/kg	mg/kg

Fraction	Analytes	Result	Q	RL	Result	Q	RL	Result	Q	RL	Result	Q	RL
Aliphatic	C5-C6 Aliphatics		U	8,550		U	5,990		U	1,650		U	1,650
Aliphatic	>C6-C8 Aliphatics	1,526	J	8,550	1,406	J	5,990		U	1,650	780	J	1,650
Aliphatic	>C8-C10 Aliphatics	23,794		2,940	31,373		2,950	60,460		1,650	151,534		1,650
Aliphatic	>C10-C12 Aliphatics	80,983		2,940	61,092		2,950	278,612		1,650	180,422		1,650
Aliphatic	>C12-C16 Aliphatics	203,122		2,940	196,045		2,950	315,662		1,650	234,688		1,650
Aliphatic	>C16-C21 Aliphatics	166,328		2,940	212,713		2,950	2,264		1,650	20,794		1,650
Aliphatic	>C21-C32 Aliphatics	33,481		2,940	35,117		2,950		U	1,650		U	1,650
Aromatic	>C8-C10 Aromatics	6,507		2,940	22,417		2,950	7,506		1,650	30,291		1,650
Aromatic	>C10-C12 Aromatics	30,293		2,940	42,287		2,950	55,836		1,650	39,115		1,650
Aromatic	>C12-C16 Aromatics	111,016		2,940	110,031		2,950	90,500		1,650	73,316		1,650
Aromatic	>C16-C21 Aromatics	82,640		2,940	75,319		2,950	1,696		1,650	5,797		1,650
Aromatic	>C21-C32 Aromatics	15,036		2,940	12,839		2,950		U	1,650		U	1,650
Combined	>C8-C10 Combined	49,868		5,880	84,424		5,900	106,536		6,600	285,428		6,600
Combined	>C10-C12 Combined	152,064		5,880	137,585		5,900	440,808		6,600	295,541		6,600
Combined	>C12-C16 Combined	357,797		5,880	363,823		5,900	460,178		6,600	364,544		6,600
Combined	>C16-C21 Combined	263,613		5,880	317,428		5,900		U	6,600	29,586		6,600
Combined	>C21-C32 Combined	56,726		5,880	52,789		5,900		U	6,600		U	6,600

Project Name: Hawaii DOH - Fi

Client ID	BUNKER C	WASTE OIL (AUTO)
Matrix	OIL	OIL
Reference Method	VPH/8015D(M)	VPH/8015D(M)
Batch ID	WG1676301	WG1682983
Date Collected	7/26/2022	7/26/2022
Date Received	7/29/2022	7/29/2022
Date Prepped	8/17/2022	9/2/2022
Date Analyzed	8/18/2022	9/7/2022
Sample Size(wet)	0.1035	0.1119
% Solid	100	100
File ID	f1708172244	f1709062236
Lab ID Combined:	L2240634-25	L2240634-32
Lab ID F1:	L2240634-26	L2240634-33
Lab ID F2:	L2240634-27	L2240634-34
Units	mg/kg	mg/kg

Fraction	Analytes	Result	Q	RL	Result	Q	RL
Aliphatic	C5-C6 Aliphatics		U	855		U	248
Aliphatic	>C6-C8 Aliphatics		U	855	597		248
Aliphatic	>C8-C10 Aliphatics		U	3,190		U	2,950
Aliphatic	>C10-C12 Aliphatics	14,228		3,190		U	2,950
Aliphatic	>C12-C16 Aliphatics	51,074		3,190	1,822	J	2,950
Aliphatic	>C16-C21 Aliphatics	68,425		3,190	9,434		2,950
Aliphatic	>C21-C32 Aliphatics	182,967		3,190	652,672		2,950
Aromatic	>C8-C10 Aromatics		U	3,190	2,177	J	2,950
Aromatic	>C10-C12 Aromatics	6,891		3,190	3,629		2,950
Aromatic	>C12-C16 Aromatics	30,159		3,190	4,970		2,950
Aromatic	>C16-C21 Aromatics	37,074		3,190	6,738		2,950
Aromatic	>C21-C32 Aromatics	84,564		3,190	60,655		2,950
Combined	>C8-C10 Combined		U	12,800	3,762	J	5,900
Combined	>C10-C12 Combined	59,346		12,800	5,203	J	5,900
Combined	>C12-C16 Combined	189,840		12,800	7,246		5,900
Combined	>C16-C21 Combined	222,386		12,800	15,089		5,900
Combined	>C21-C32 Combined	568,242		12,800	622,151		5,900

Attachment B: FID Chromatograms - Whole Extract

File :C:\Projects\Hawaii DOH\2. Laboratory Data\Alpha\Carbon Range  
... Study\L2240634\TPH\NF TPH\f1708172220.D  
Operator : FID17:WR  
Instrument : FID17  
Acquired : 18 Aug 2022 1:41 am using AcqMethod FID17A.M  
Sample Name: L2240634-01,42,,  
Misc Info : WG1676467,WG1676301,ICAL18753

Whole Extract  
GASOLINE 87  
L2240634-01  
Product

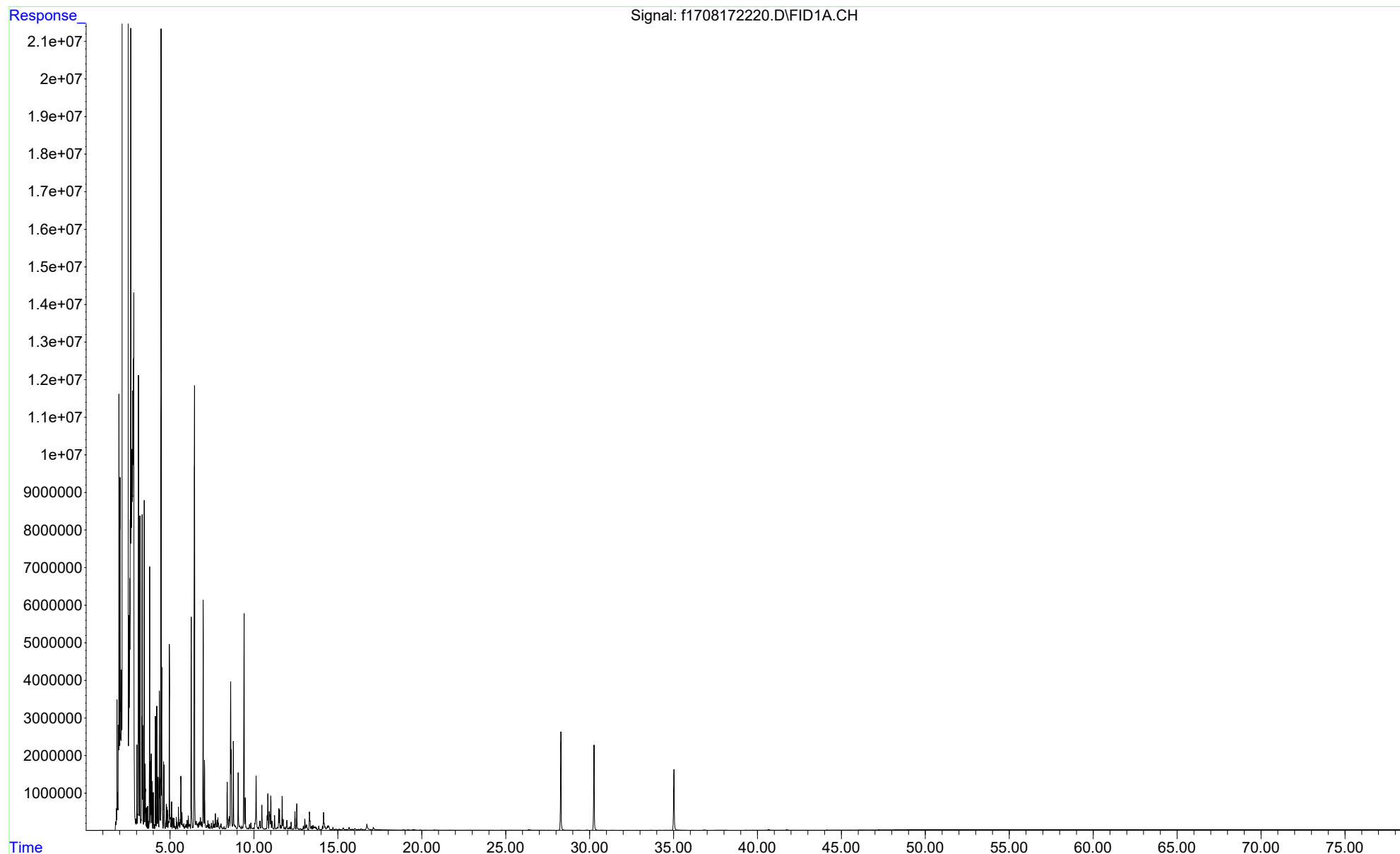

File :C:\Projects\Hawaii DOH\2. Laboratory Data\Alpha\Carbon Range  
... Study\L2240634\TPH\NF TPH\f1708172222.D  
Operator : FID17:WR  
Instrument : FID17  
Acquired : 18 Aug 2022 3:10 am using AcqMethod FID17A.M  
Sample Name: WG1676301-4,42,,  
Misc Info : WG1676467,WG1676301,ICAL18753

Whole Extract  
GASOLINE 87 Duplicate  
L2240634-01  
Product

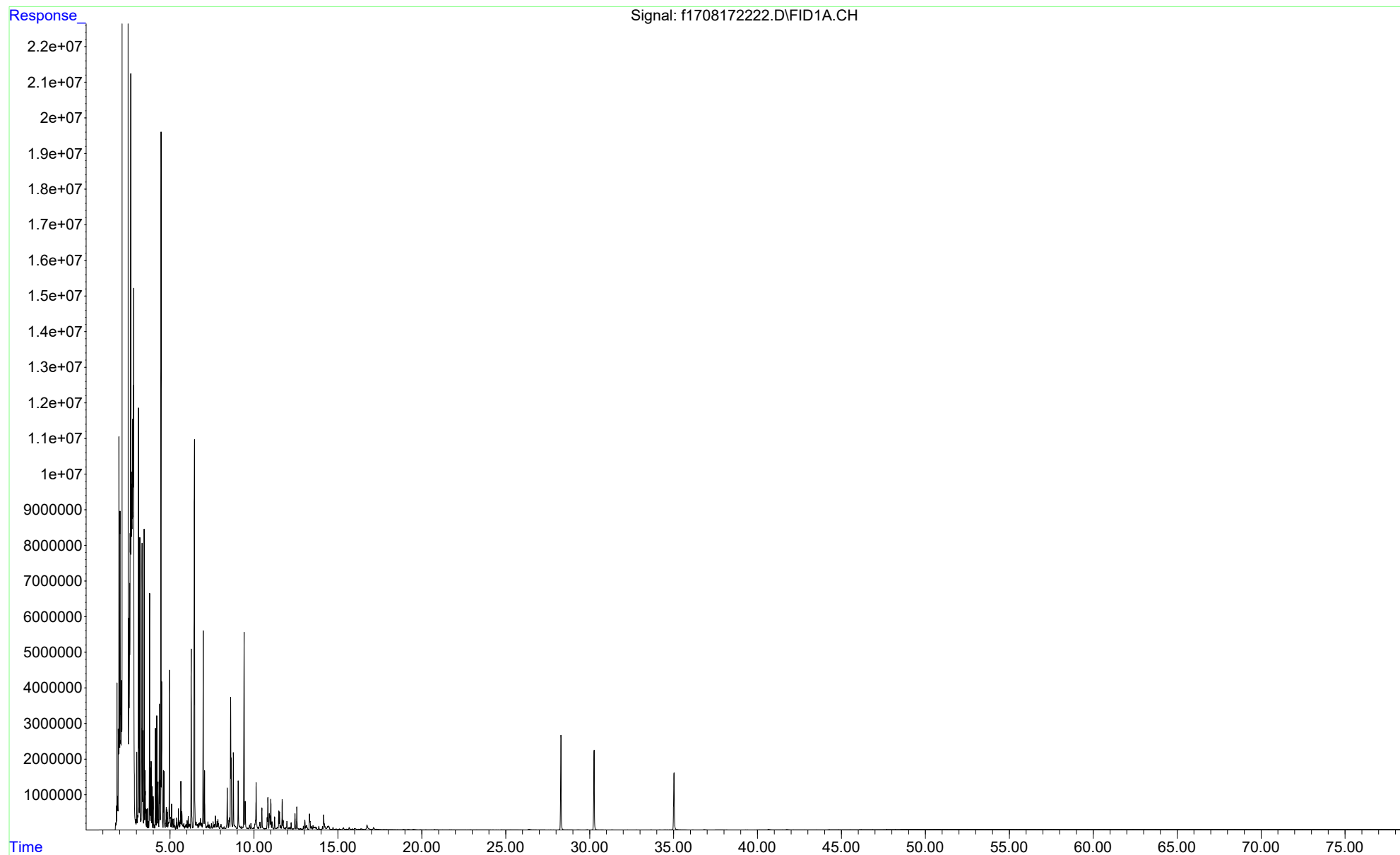

File :C:\Projects\Hawaii DOH\2. Laboratory Data\Alpha\Carbon Range  
... Study\L2240634\TPH\NF TPH\f1708172224.D  
Operator : FID17:WR  
Instrument : FID17  
Acquired : 18 Aug 2022 4:40 am using AcqMethod FID17A.M  
Sample Name: L2240634-04,42,,  
Misc Info : WG1676467,WG1676301,ICAL18753

Whole Extract  
GASOLINE 91  
L2240634-04  
Product

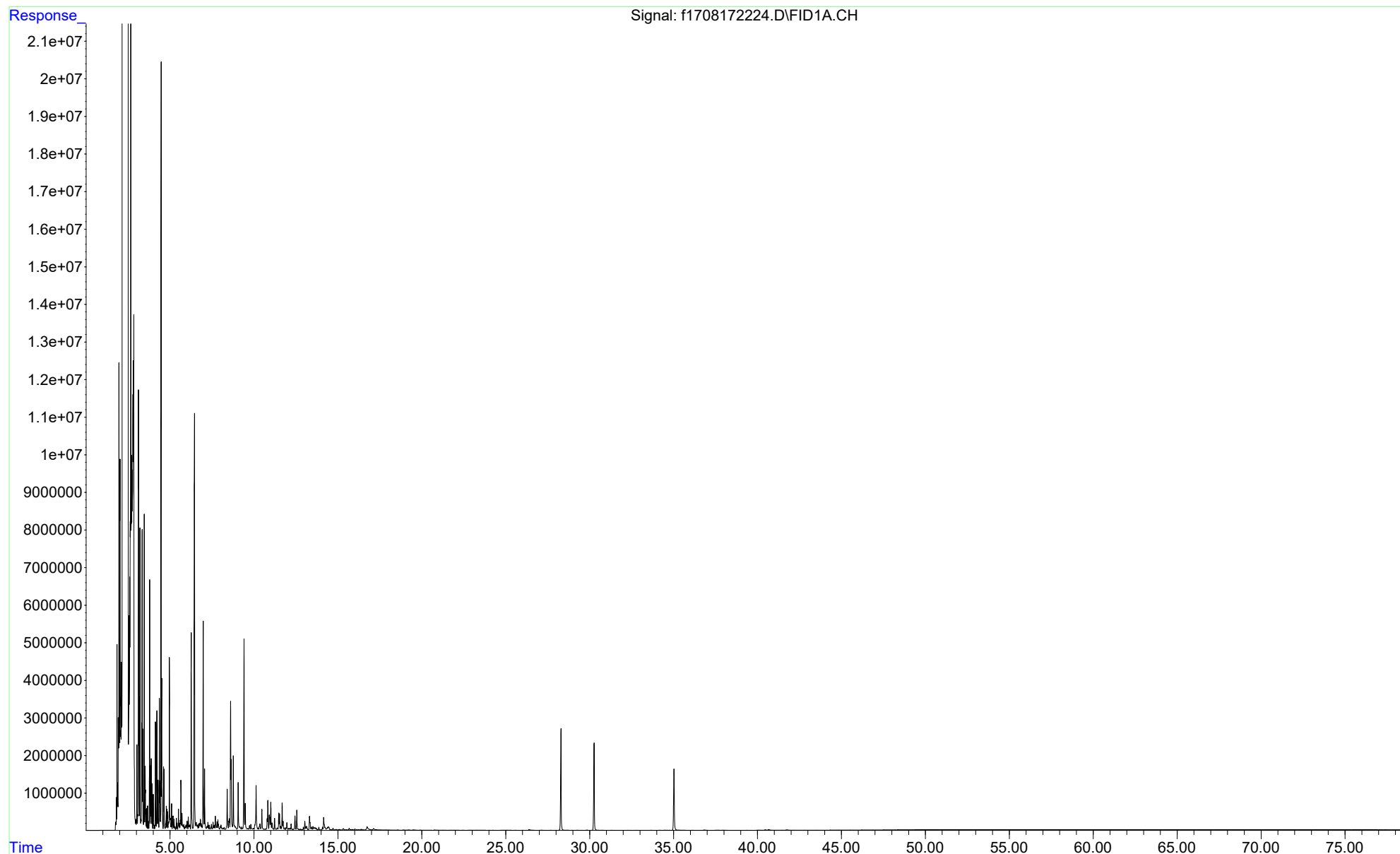



File :C:\Projects\Hawaii DOH\2. Laboratory Data\Alpha\Carbon Range  
... Study\L2240634\TPH\NF TPH\f1708172226.D  
Operator : FID17:WR  
Instrument : FID17  
Acquired : 18 Aug 2022 6:10 am using AcqMethod FID17A.M  
Sample Name: L2240634-07,42,,  
Misc Info : WG1676467,WG1676301,ICAL18753

Whole Extract  
GASOLINE 93  
L2240634-07  
Product

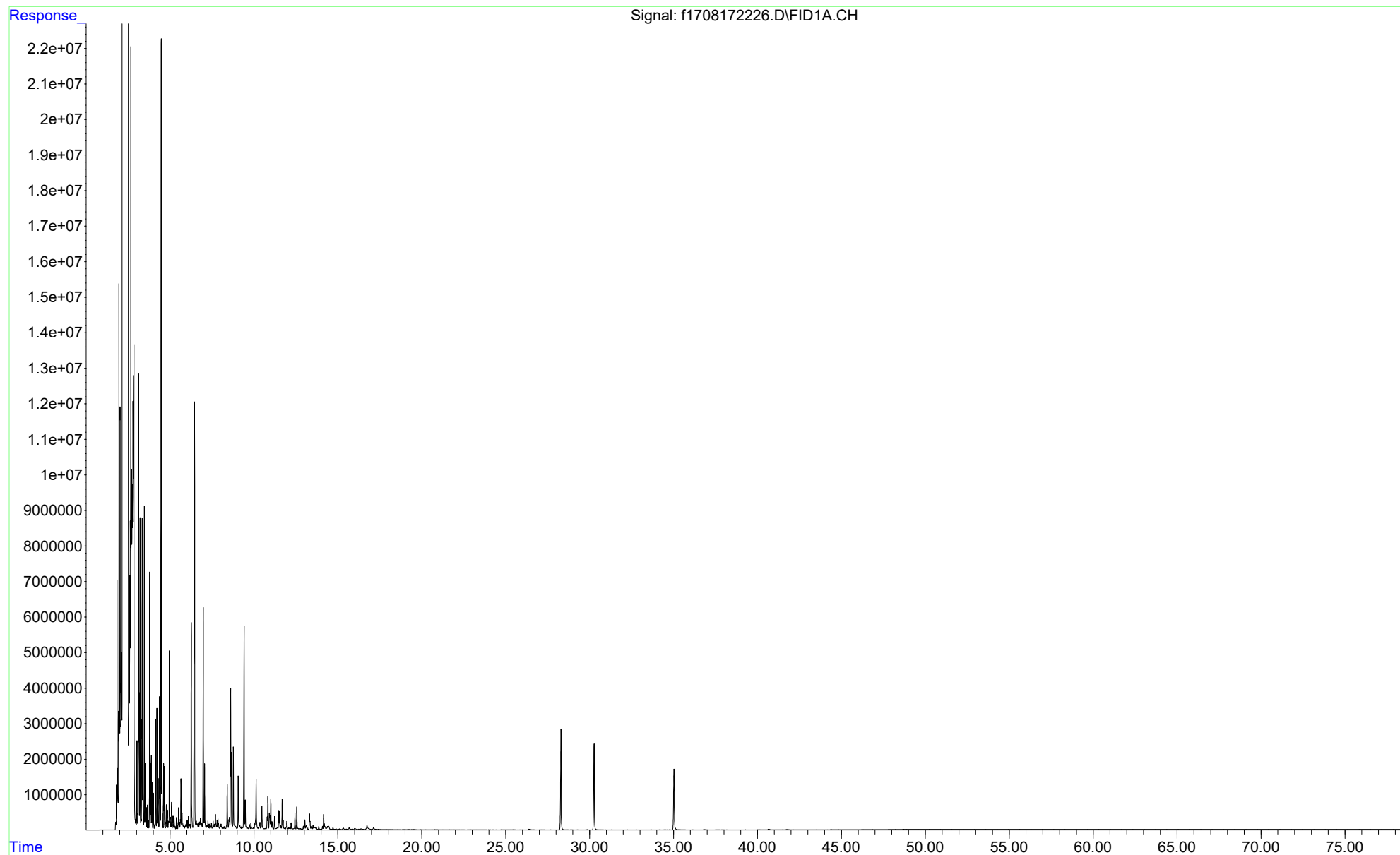

File :C:\Projects\Hawaii DOH\2. Laboratory Data\Alpha\Carbon Range  
... Study\L2240634\TPH\NF TPH\f1708172228.D  
Operator : FID17:WR  
Instrument : FID17  
Acquired : 18 Aug 2022 7:40 am using AcqMethod FID17A.M  
Sample Name: L2240634-10,42,,  
Misc Info : WG1676467,WG1676301,ICAL18753

Whole Extract  
HEATING FUEL  
L2240634-10  
Product

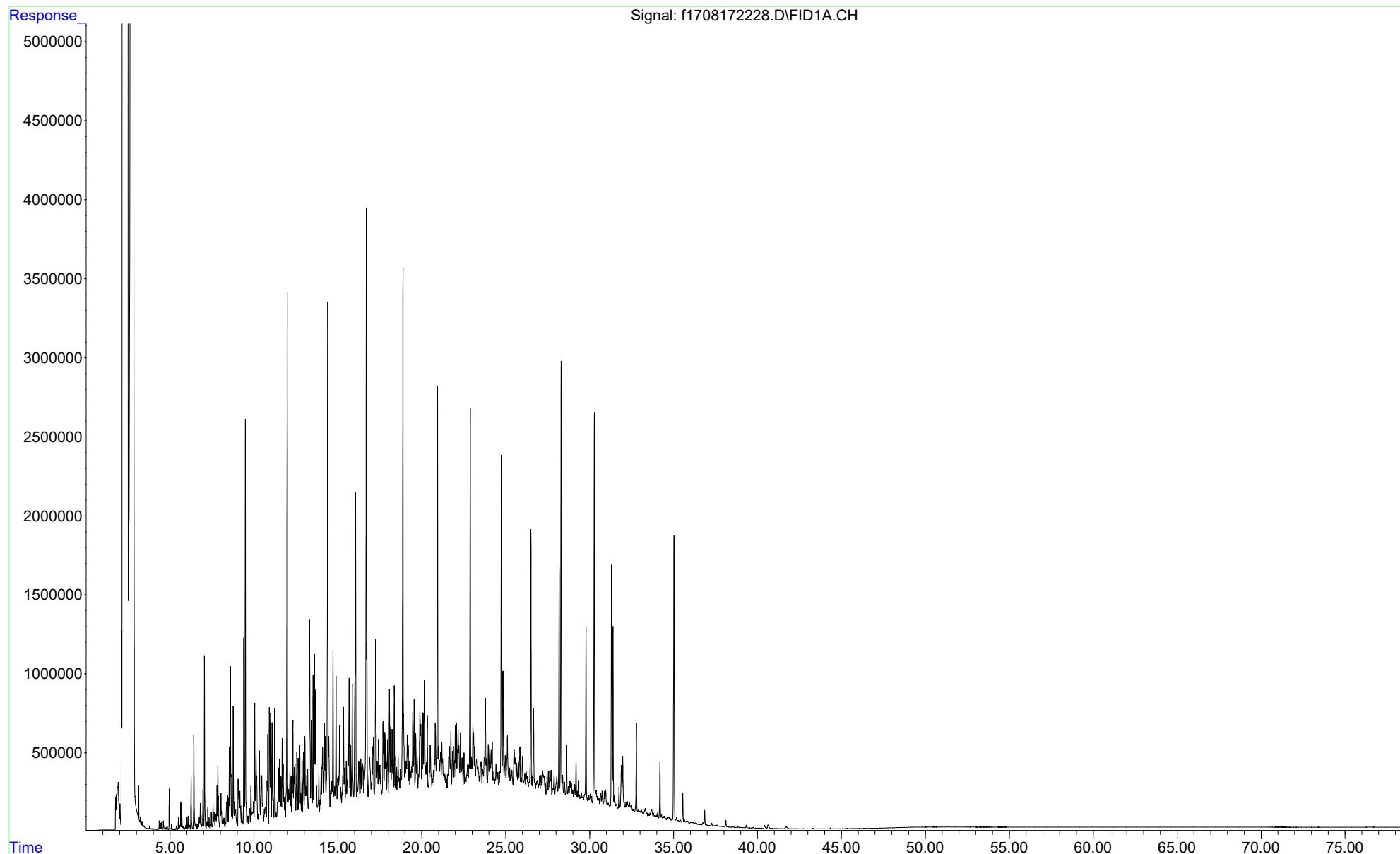

File :C:\Projects\Hawaii DOH\2. Laboratory Data\Alpha\Carbon Range  
... Study\L2240634\TPH\NF TPH\f1708172230.D  
Operator : FID17:WR  
Instrument : FID17  
Acquired : 18 Aug 2022 9:10 am using AcqMethod FID17A.M  
Sample Name: L2240634-13,42,,  
Misc Info : WG1676467,WG1676301,ICAL18753

Whole Extract  
ROAD DIESEL  
L2240634-13  
Product

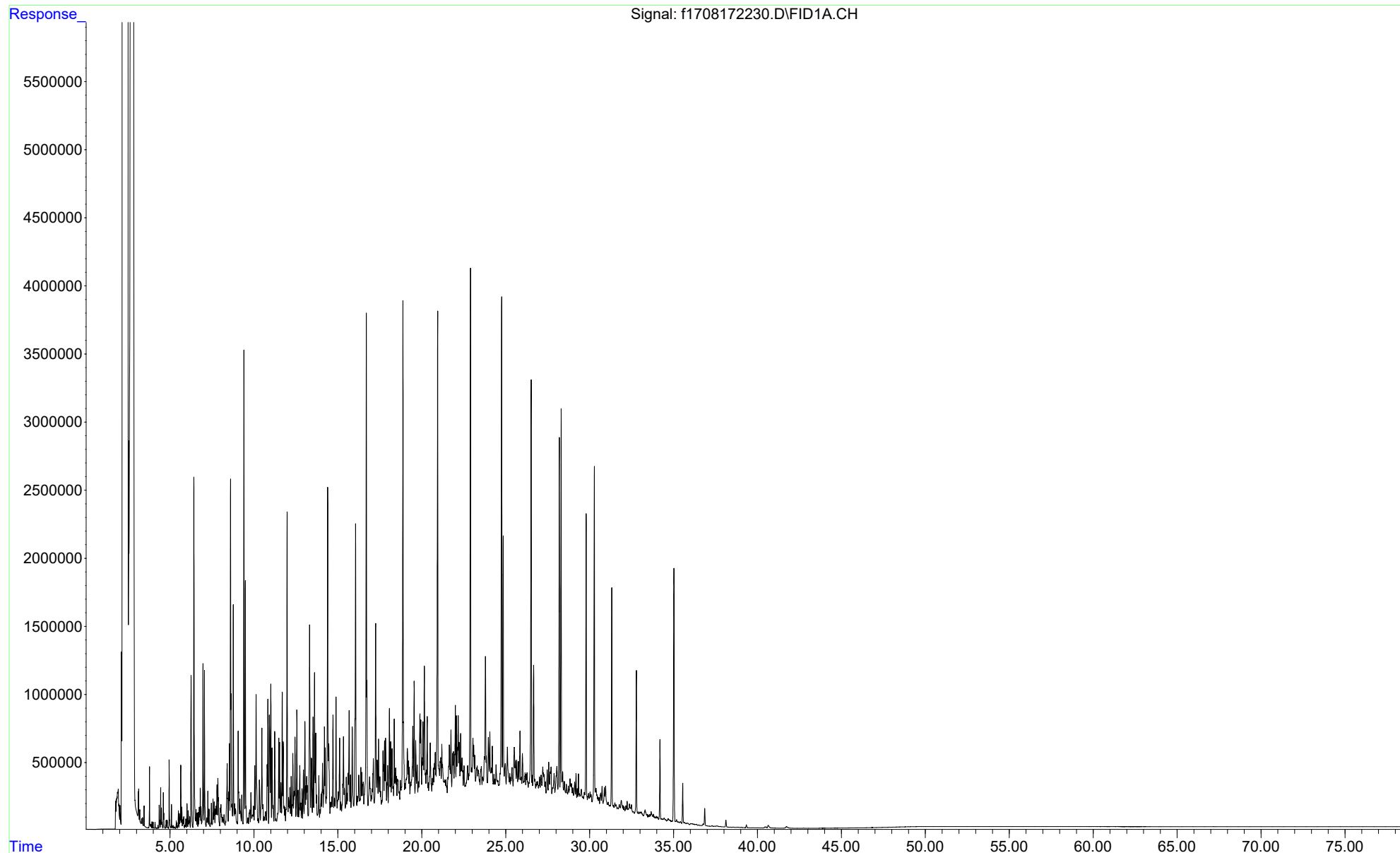

File :C:\Projects\Hawaii DOH\2. Laboratory Data\Alpha\Carbon Range  
... Study\L2240634\TPH\NF TPH\f1708172232.D  
Operator : FID17:WR  
Instrument : FID17  
Acquired : 18 Aug 2022 10:41 am using AcqMethod FID17A.M  
Sample Name: L2240634-16,42,,  
Misc Info : WG1676467,WG1676301,ICAL18753

Whole Extract  
JP-5  
L2240634-16  
Product

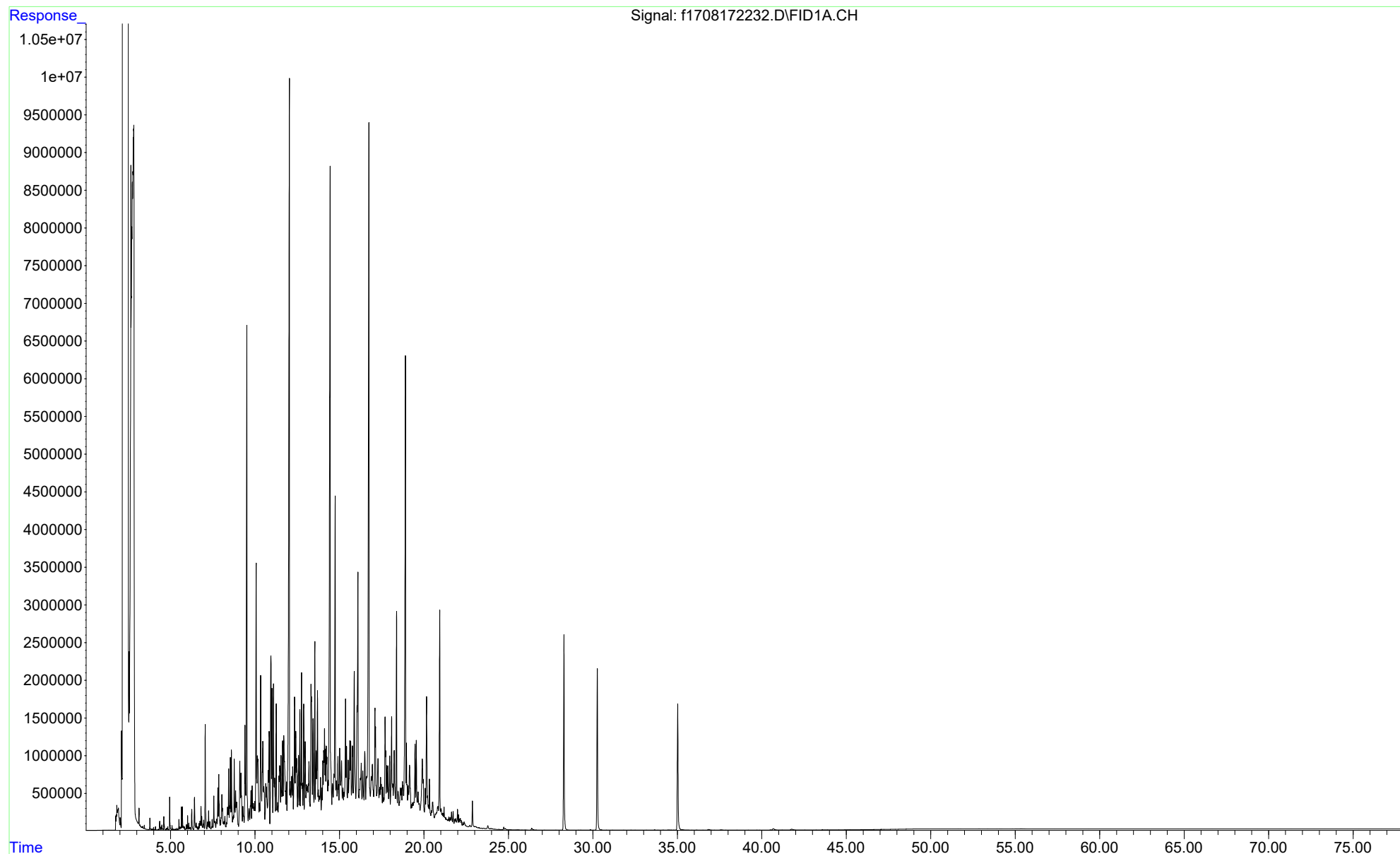

File :C:\Projects\Hawaii DOH\2. Laboratory Data\Alpha\Carbon Range  
... Study\L2240634\TPH\NF TPH\f1708172240.D  
Operator : FID17:WR  
Instrument : FID17  
Acquired : 18 Aug 2022 16:46 pm using AcqMethod FID17A.M  
Sample Name: L2240634-19,42,,  
Misc Info : WG1676467,WG1676301,ICAL18753

Whole Extract  
JP-8  
L2240634-19  
Product

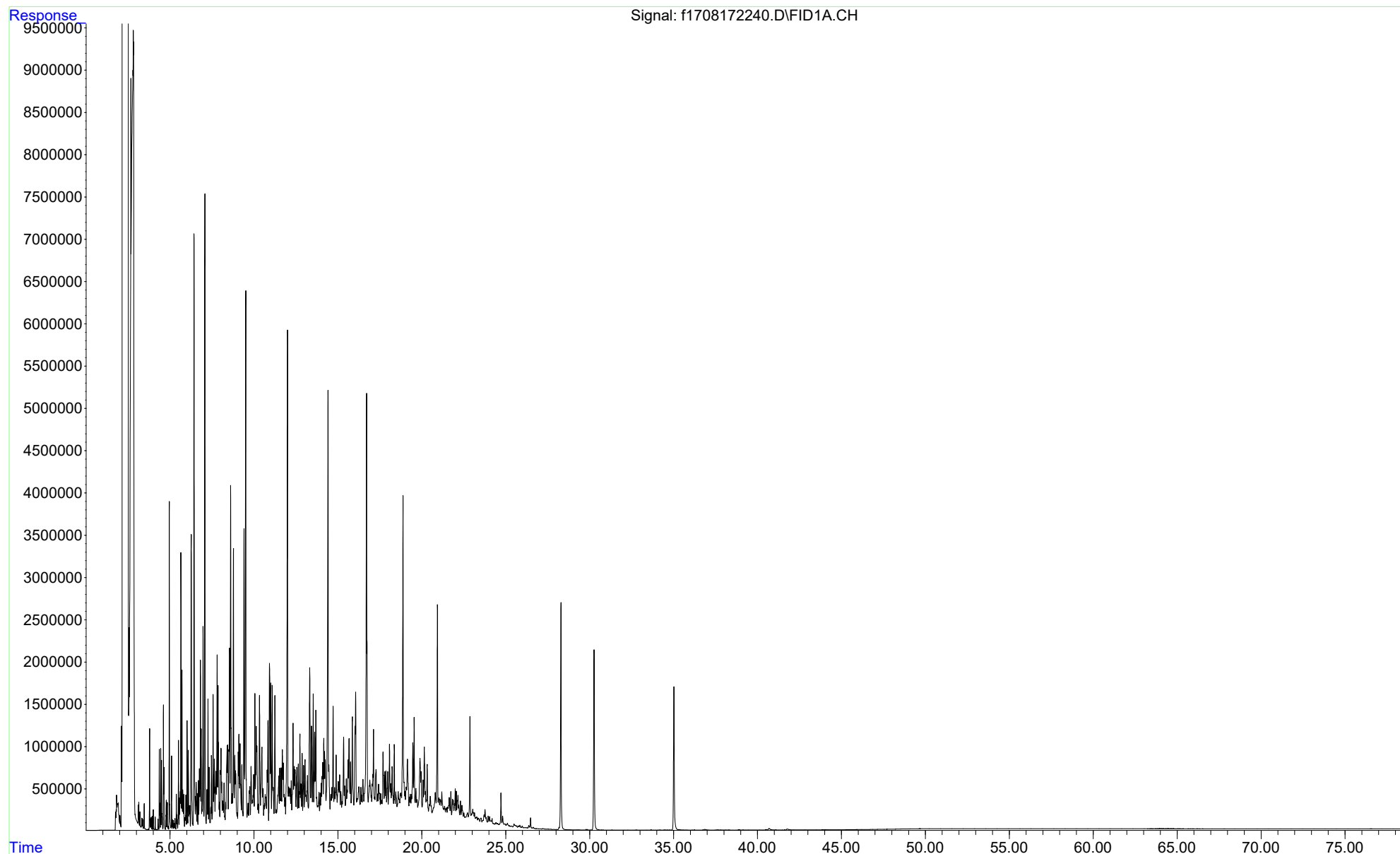

File :C:\Projects\Hawaii DOH\2. Laboratory Data\Alpha\Carbon Range  
... Study\L2240634\TPH\NF TPH\f1708172244.D  
Operator : FID17:WR  
Instrument : FID17  
Acquired : 18 Aug 2022 19:48 pm using AcqMethod FID17A.M  
Sample Name: L2240634-25,42,,  
Misc Info : WG1676467,WG1676301,ICAL18753

Whole Extract  
BUNKER C  
L2240634-25  
Product

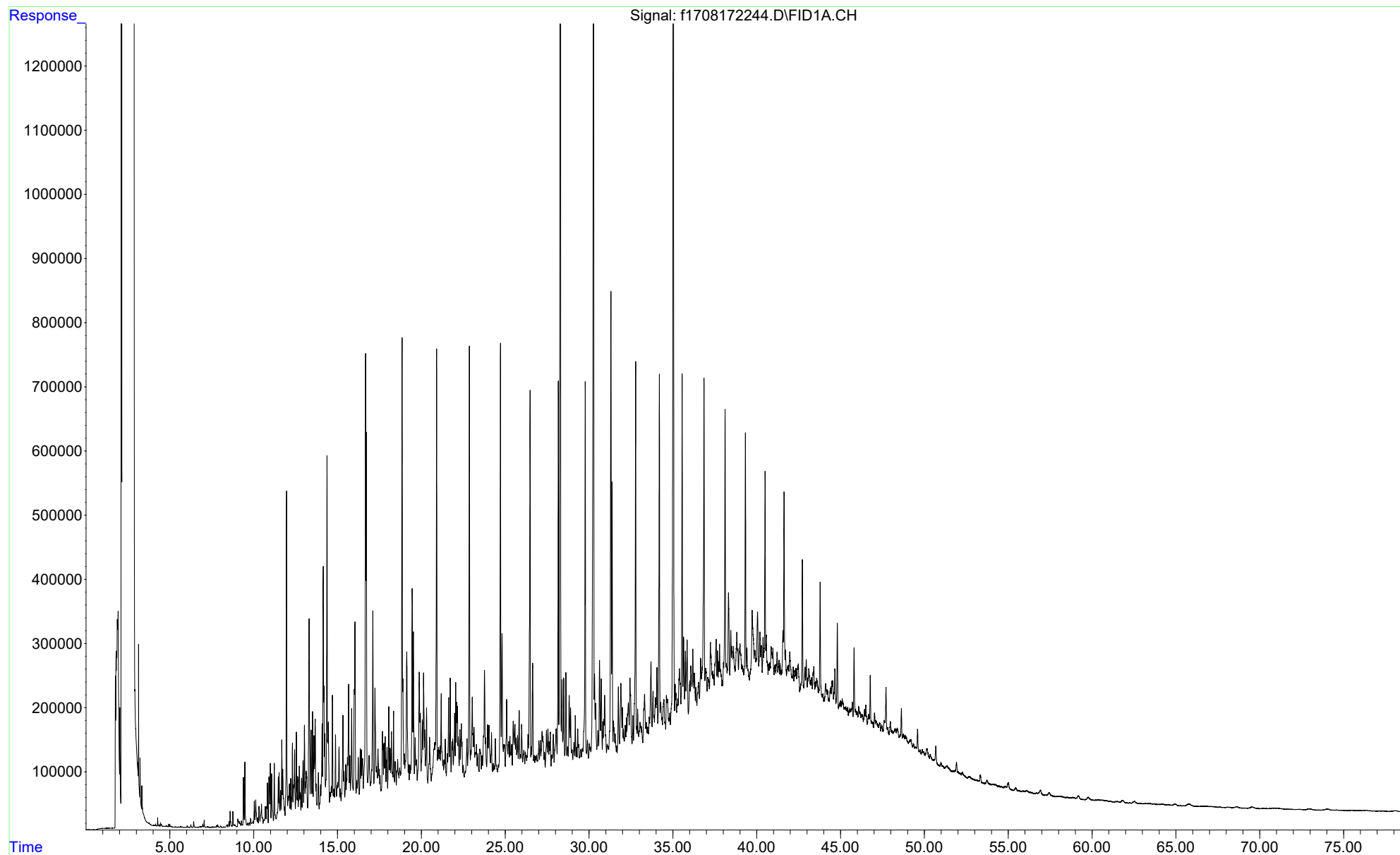

File :C:\Projects\Hawaii DOH\2. Laboratory Data\Alpha\Carbon Range  
... Study\L2240634\TPH\NF TPH\f1709062236.D  
Operator : FID17:WR  
Instrument : FID17  
Acquired : 07 Sep 2022 16:05 pm using AcqMethod FID17A.M  
Sample Name: L2240634-32,42,,  
Misc Info : WG1684077,WG1682983,ICAL18753

Whole Extract  
WASTE OIL (AUTO)  
L2240634-32  
Product

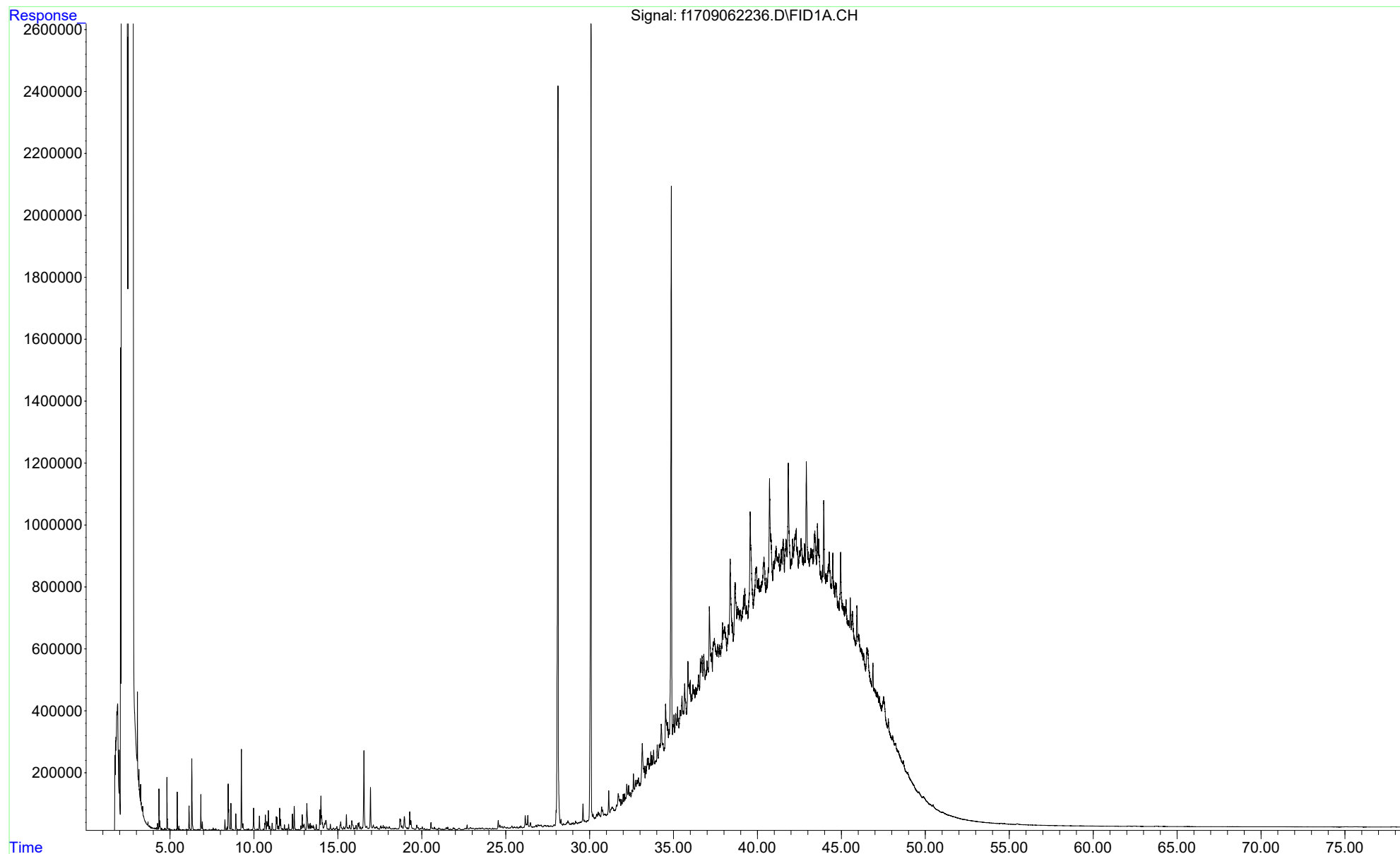

File :C:\Projects\Hawaii DOH\2. Laboratory Data\Alpha\Carbon Range  
... Study\L2240634\TPH\NF TPH\f1708172212.D  
Operator : FID17:WR  
Instrument : FID17  
Acquired : 17 Aug 2022 19:40 pm using AcqMethod FID17A.M  
Sample Name: WG1676301-1,42,,  
Misc Info : WG1676467,WG1676301,ICAL18753

Whole Extract  
Method Blank

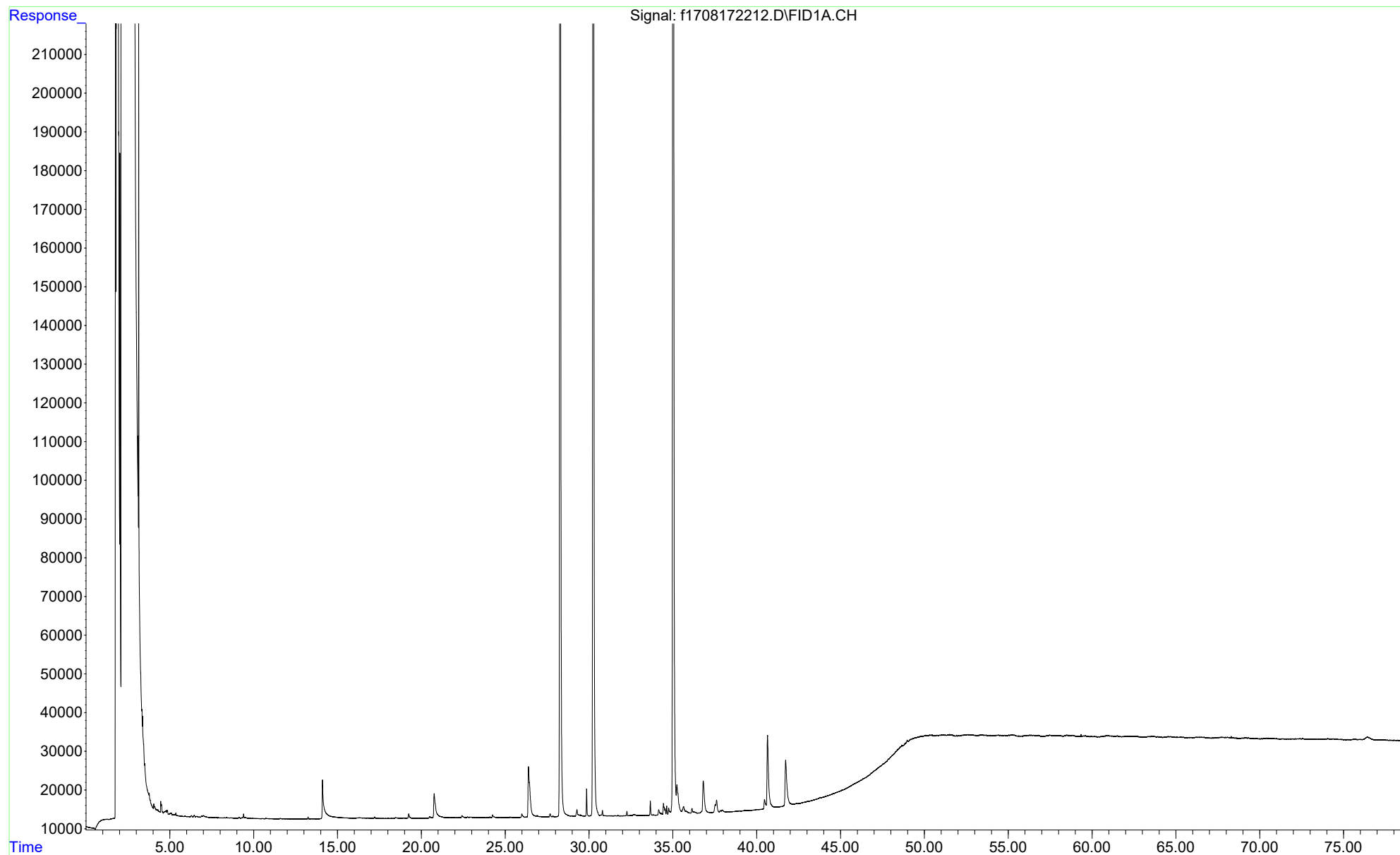



File :C:\Projects\Hawaii DOH\2. Laboratory Data\Alpha\Carbon Range  
... Study\L2240634\TPH\NF TPH\f1708172210.D  
Operator : FID17:WR  
Instrument : FID17  
Acquired : 17 Aug 2022 18:10 pm using AcqMethod FID17A.M  
Sample Name: IB1708172201F  
Misc Info :

Whote Extract  
Instrument Blank

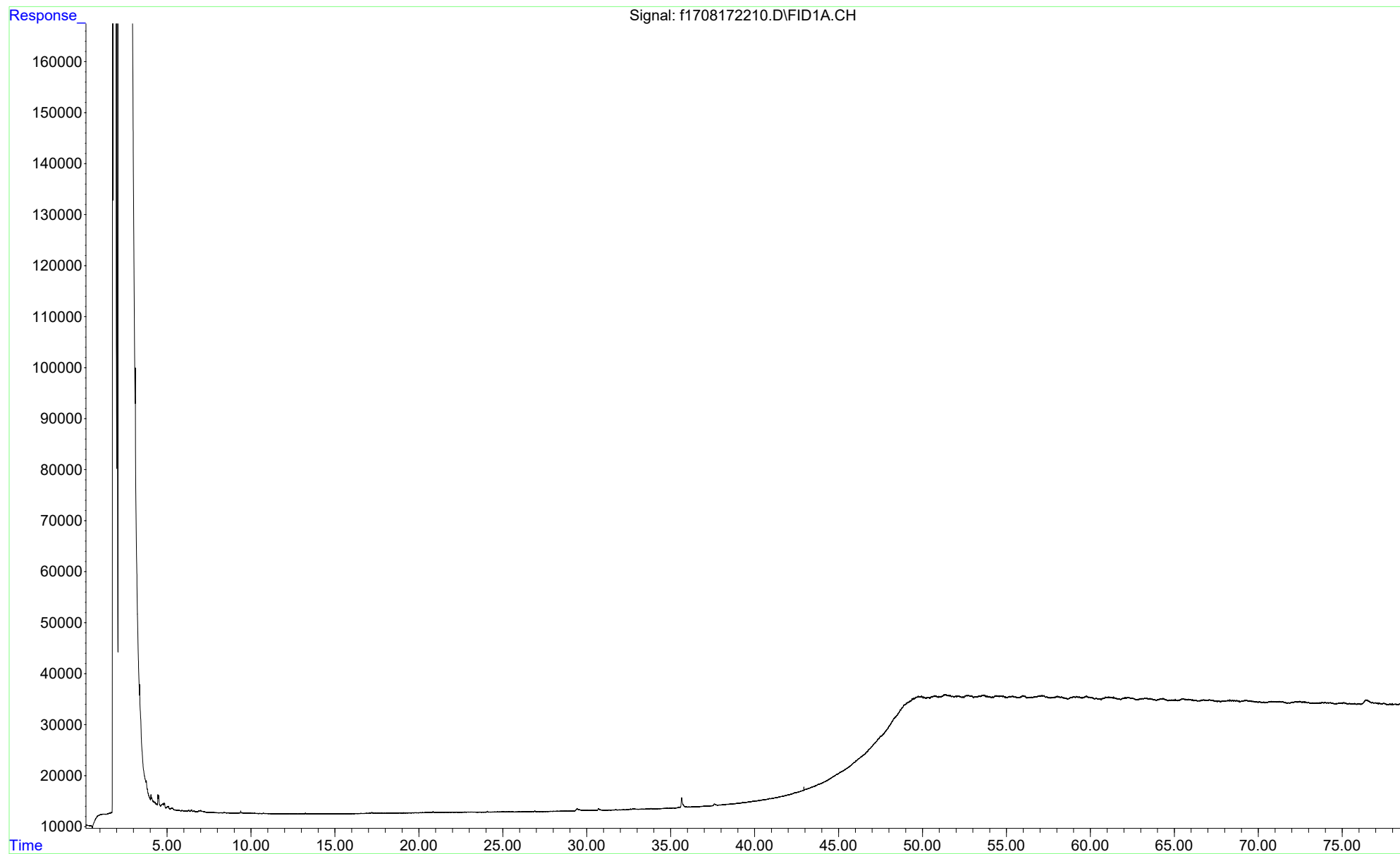

File :C:\Projects\Hawaii DOH\2. Laboratory Data\Alpha\Carbon Range  
... Study\L2240634\TPH\NF TPH\f1708172238.D  
Operator : FID17:WR  
Instrument : FID17  
Acquired : 18 Aug 2022 15:14 pm using AcqMethod FID17A.M  
Sample Name: IB1708172202F  
Misc Info :

Whote Extract  
Instrument Blank

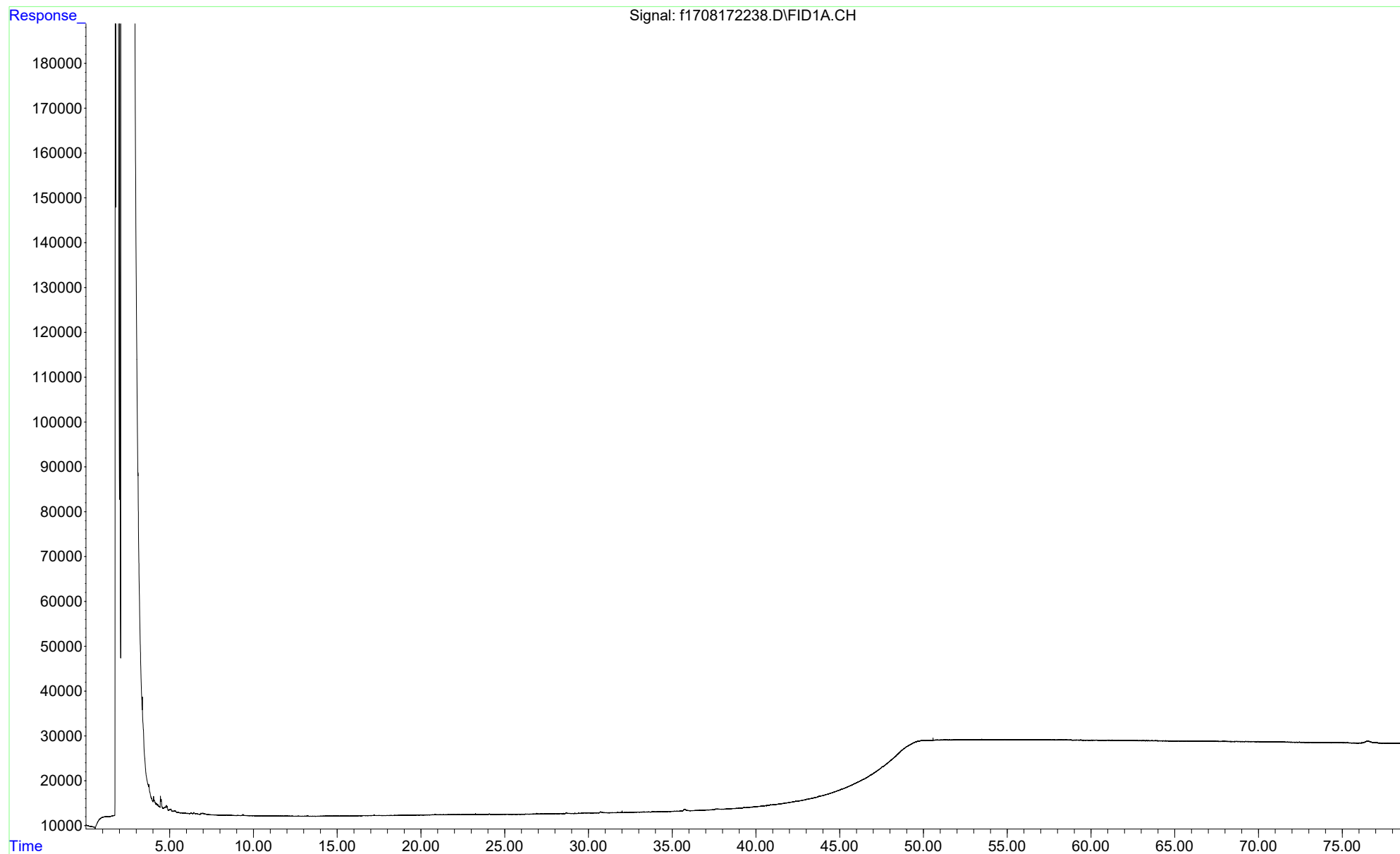

## Attachment C: FID Chromatograms Aliphatic Fraction

File :C:\Projects\Hawaii DOH\2. Laboratory Data\Alpha\Carbon Range  
... Study\L2240634\TPH\NF TPH\f1708172260.D  
Operator : FID17:WR  
Instrument : FID17  
Acquired : 19 Aug 2022 7:48 am using AcqMethod FID17A.M  
Sample Name: L2240634-02,42,,  
Misc Info : WG1676467,WG1676456,ICAL18753

F1-Aliphatic  
GASOLINE 87 F1  
L2240634-02  
Product

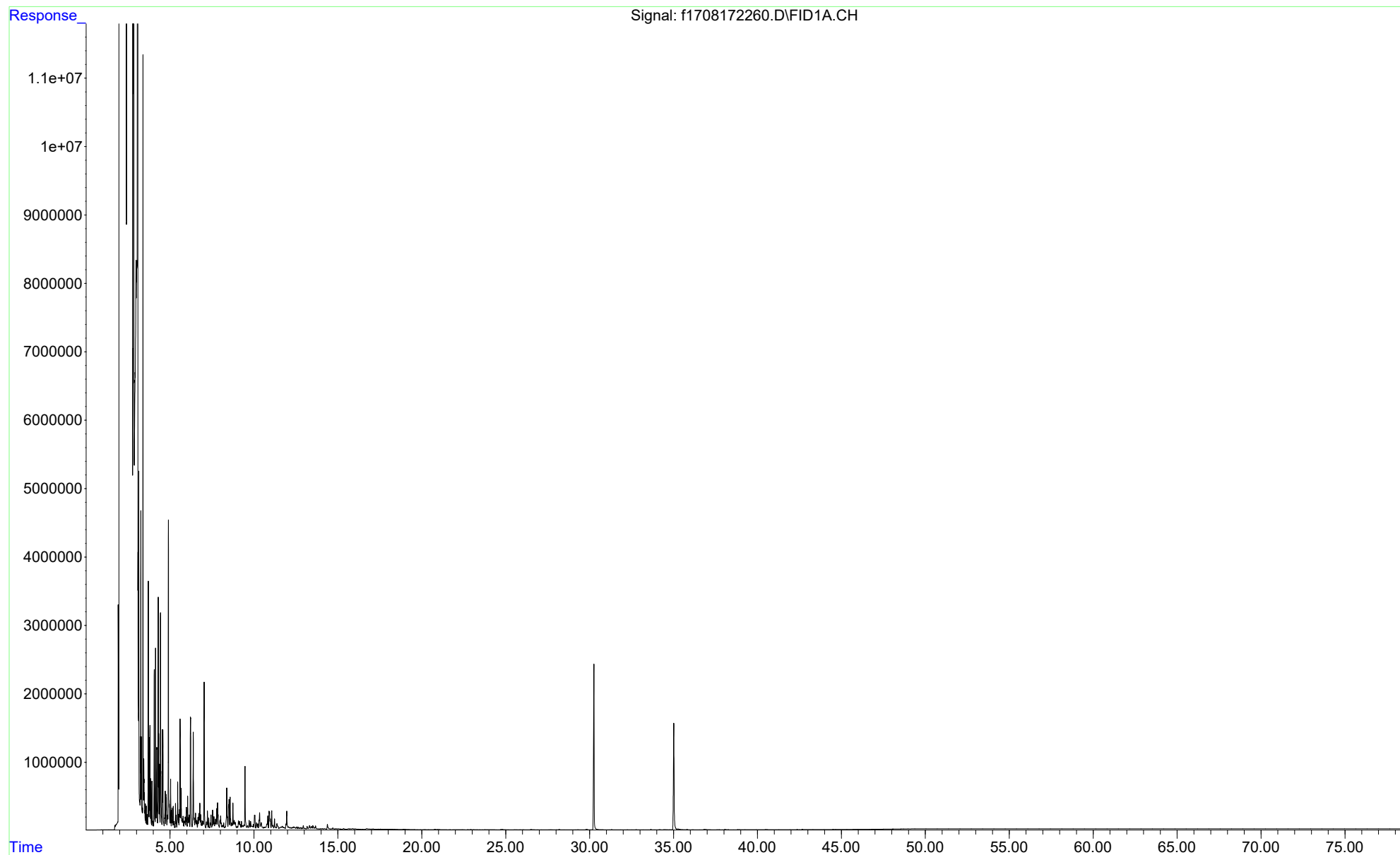

File :C:\Projects\Hawaii DOH\2. Laboratory Data\Alpha\Carbon Range  
... Study\L2240634\TPH\NF TPH\f1708172262.D  
Operator : FID17:WR  
Instrument : FID17  
Acquired : 19 Aug 2022 9:18 am using AcqMethod FID17A.M  
Sample Name: WG1676456-4,42,,  
Misc Info : WG1676467,WG1676456,ICAL18753

F1-Aliphatic  
GASOLINE 87 F1 Duplicate  
L2240634-02  
Product

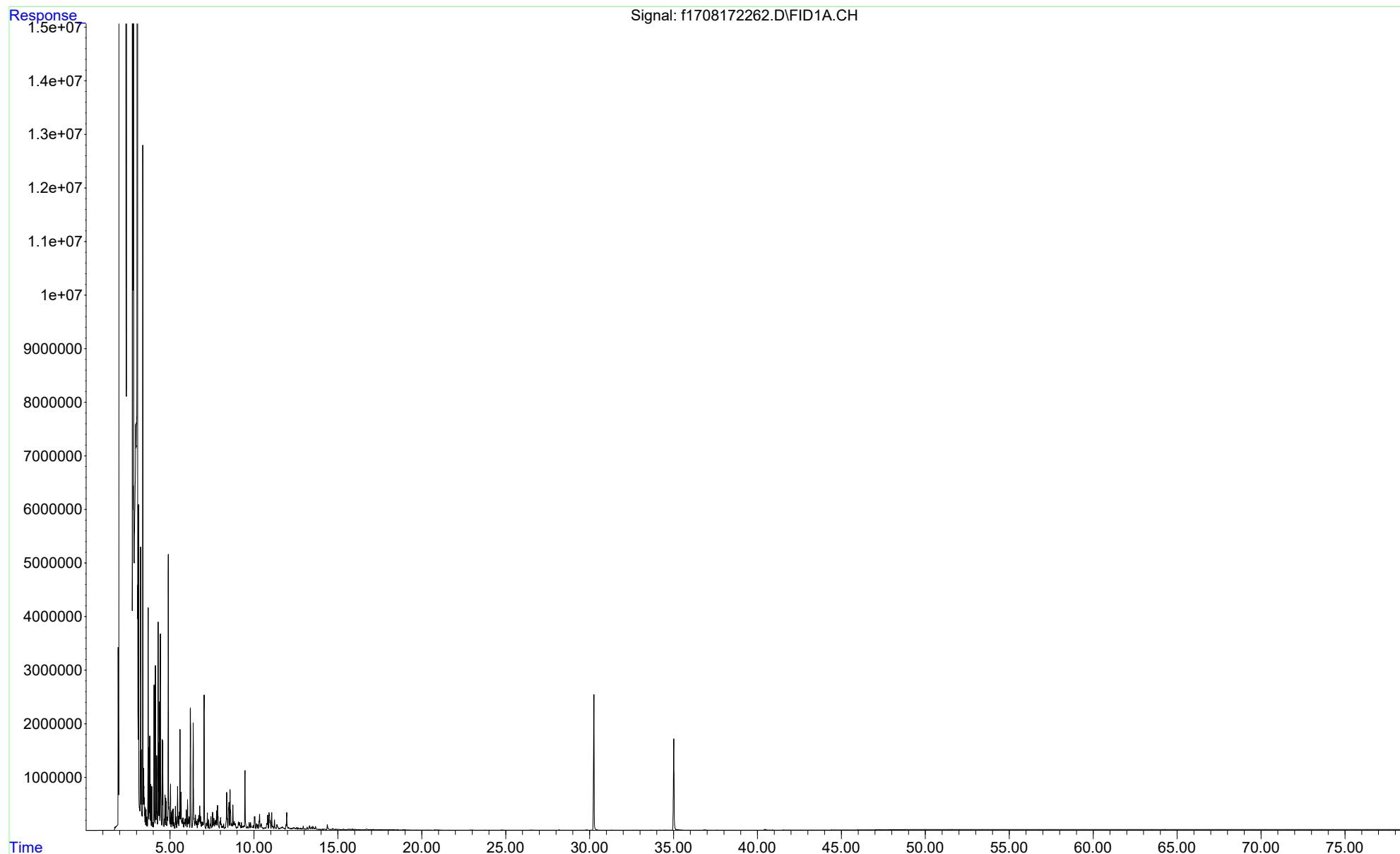

File :C:\Projects\Hawaii DOH\2. Laboratory Data\Alpha\Carbon Range  
... Study\L2240634\TPH\NF TPH\f1708172264.D  
Operator : FID17:WR  
Instrument : FID17  
Acquired : 19 Aug 2022 10:49 am using AcqMethod FID17A.M  
Sample Name: L2240634-05,42,,  
Misc Info : WG1676467,WG1676456,ICAL18753

F1-Aliphatic  
GASOLINE 91 F1  
L2240634-05  
Product

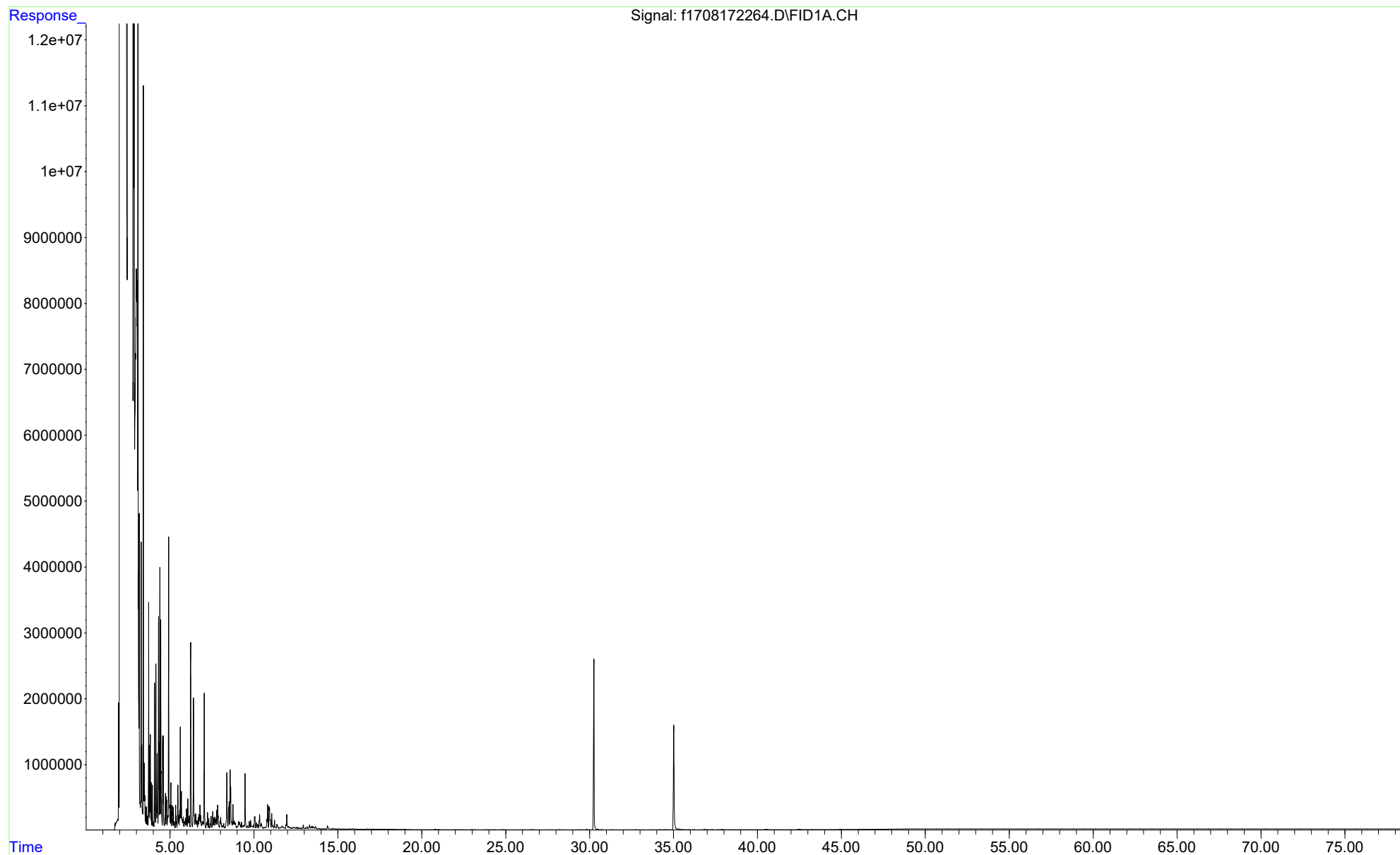

File :C:\Projects\Hawaii DOH\2. Laboratory Data\Alpha\Carbon Range  
... Study\L2240634\TPH\NF TPH\f1708172266.D  
Operator : FID17:WR  
Instrument : FID17  
Acquired : 19 Aug 2022 12:21 pm using AcqMethod FID17A.M  
Sample Name: L2240634-08,42,,  
Misc Info : WG1676467,WG1676456,ICAL18753

F1-Aliphatic  
GASOLINE 93 F1  
L2240634-08  
Product

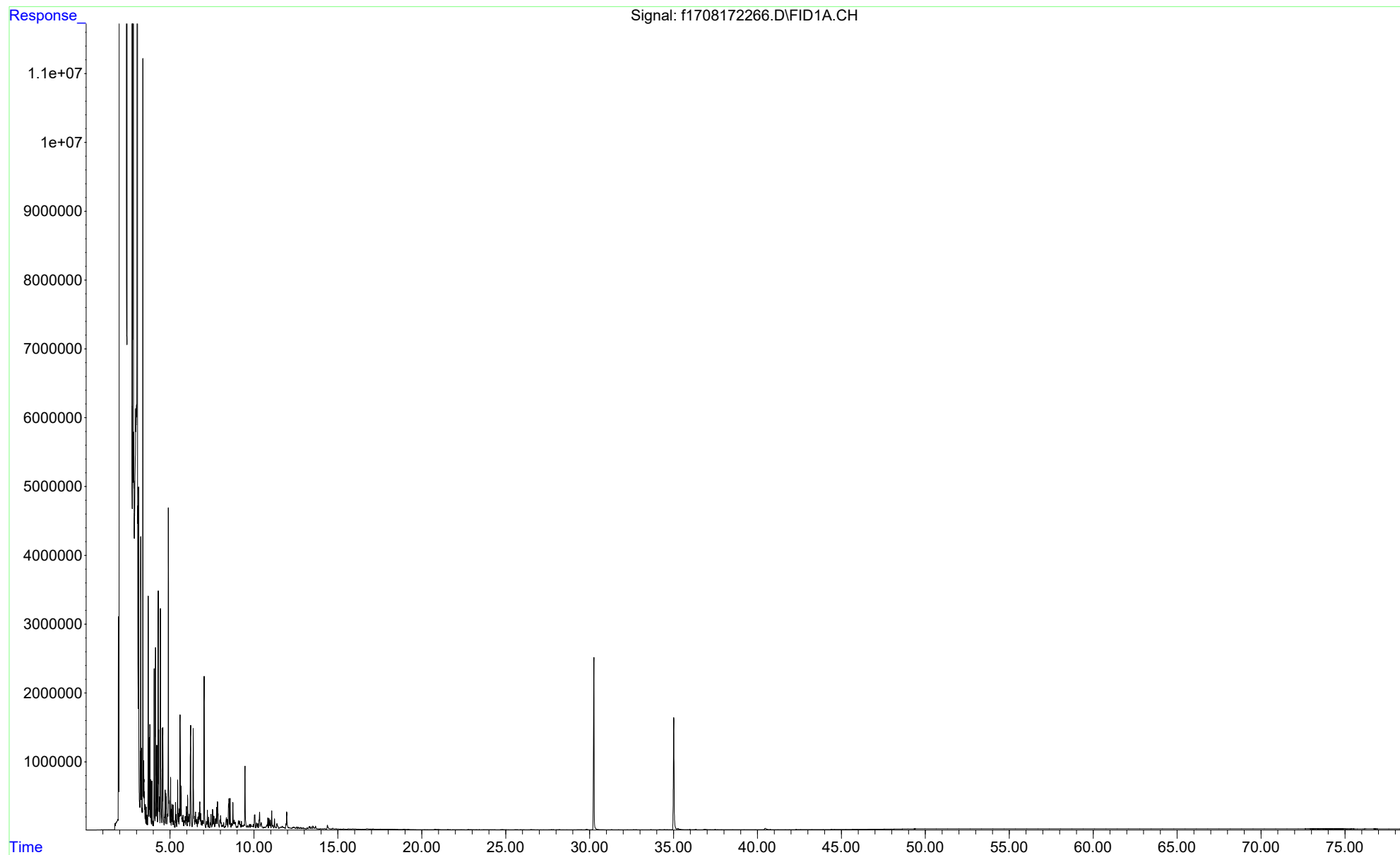

File :C:\Projects\Hawaii DOH\2. Laboratory Data\Alpha\Carbon Range  
... Study\L2240634\TPH\NF TPH\f1708172268.D  
Operator : FID17:WR  
Instrument : FID17  
Acquired : 19 Aug 2022 13:52 pm using AcqMethod FID17A.M  
Sample Name: L2240634-11,42,,  
Misc Info : WG1676467,WG1676456,ICAL18753

F1-Aliphatic  
HEATING FUEL F1  
L2240634-11  
Product

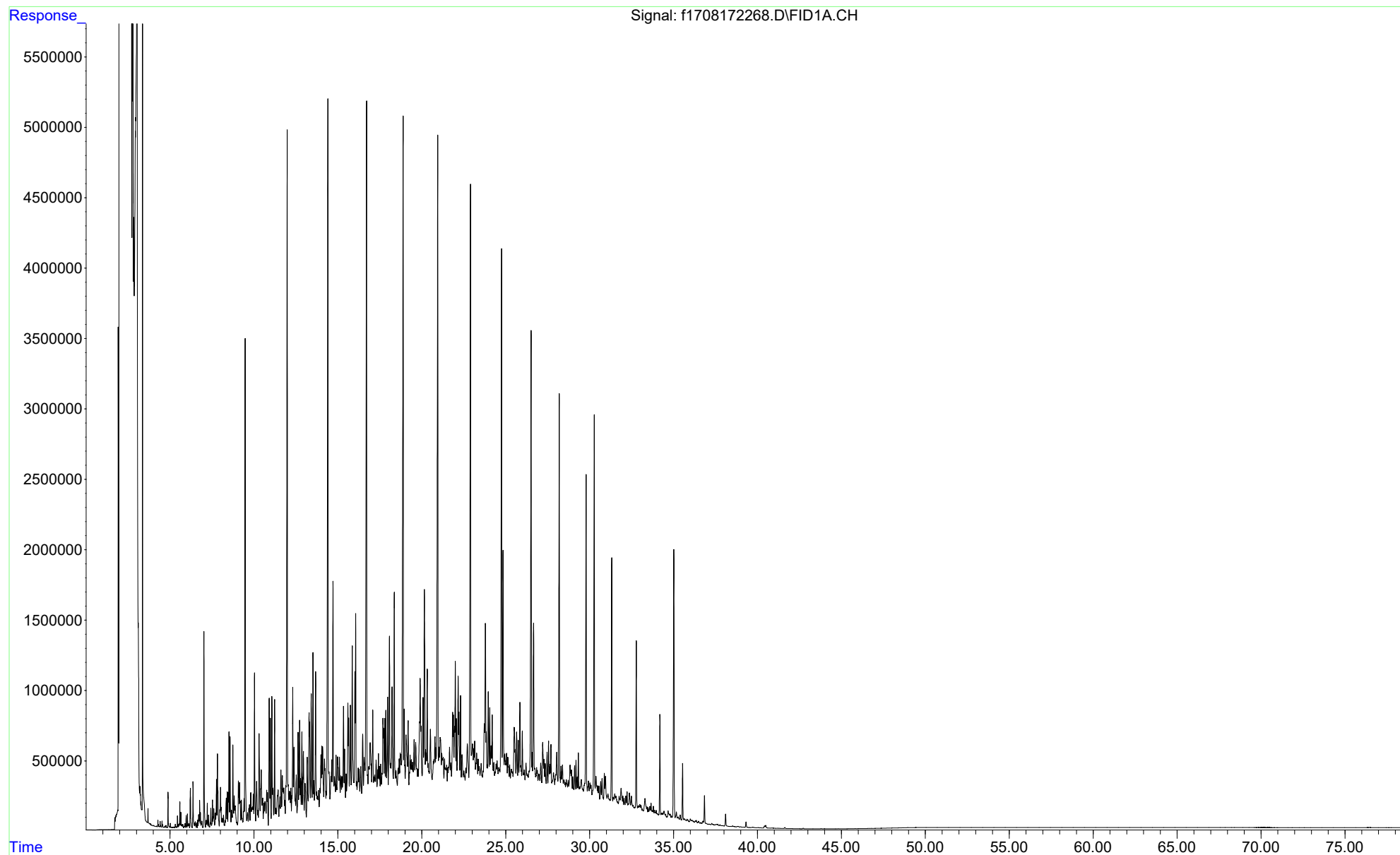



File :C:\Projects\Hawaii DOH\2. Laboratory Data\Alpha\Carbon Range  
... Study\L2240634\TPH\NF TPH\f1708172270.D  
Operator : FID17:WR  
Instrument : FID17  
Acquired : 19 Aug 2022 15:24 pm using AcqMethod FID17A.M  
Sample Name: L2240634-14,42,,  
Misc Info : WG1676467,WG1676456,ICAL18753

F1-Aliphatic  
ROAD DIESEL F1  
L2240634-14  
Product

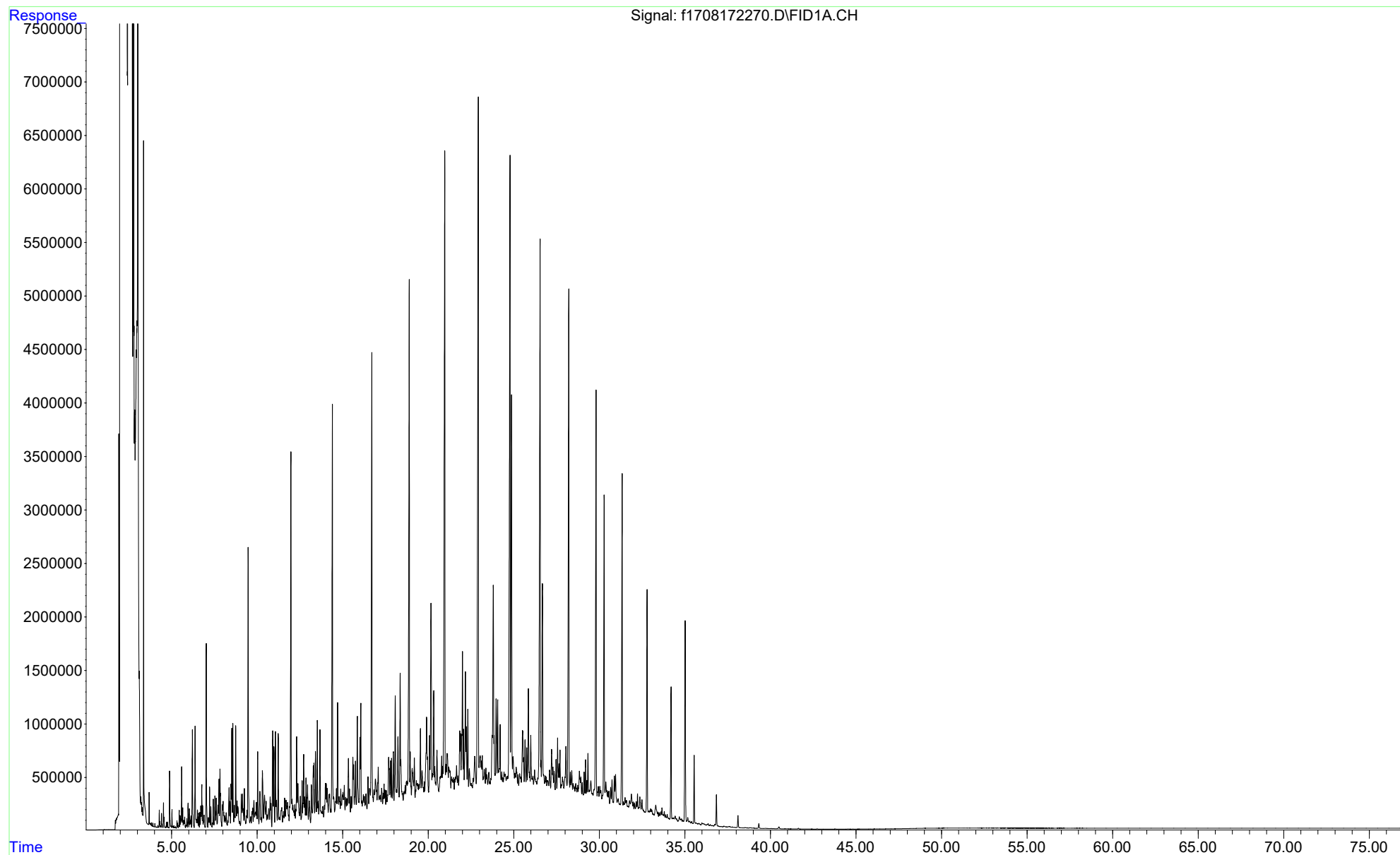

File :C:\Projects\Hawaii DOH\2. Laboratory Data\Alpha\Carbon Range  
... Study\L2240634\TPH\NF TPH\f1708172278.D  
Operator : FID17:WR  
Instrument : FID17  
Acquired : 19 Aug 2022 21:29 pm using AcqMethod FID17A.M  
Sample Name: L2240634-17,42,,  
Misc Info : WG1676467,WG1676456,ICAL18753

F1-Aliphatic  
JP-5  
L2240634-17  
Product

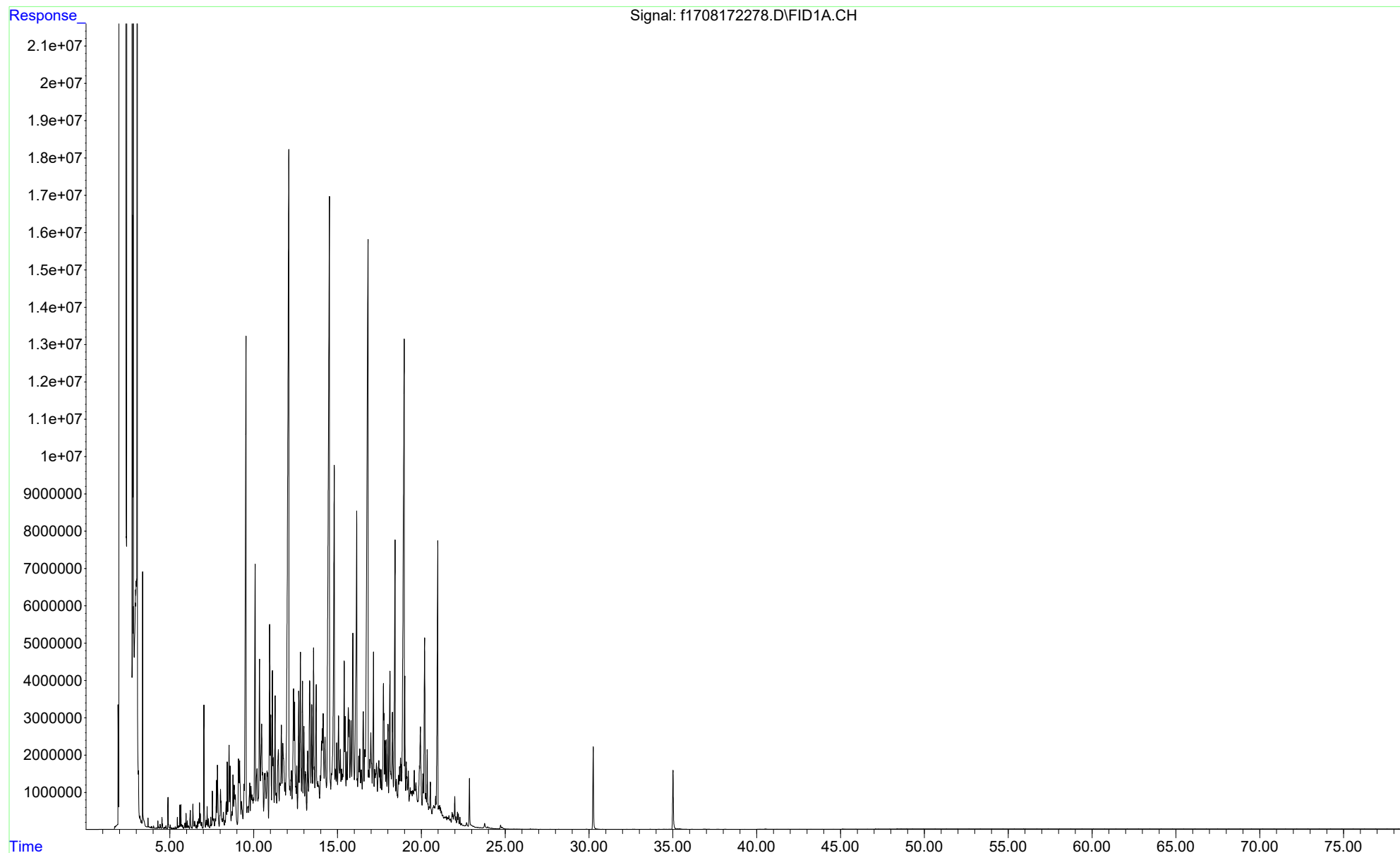

File :C:\Projects\Hawaii DOH\2. Laboratory Data\Alpha\Carbon Range  
... Study\L2240634\TPH\NF TPH\f1708172280.D  
Operator : FID17:WR  
Instrument : FID17  
Acquired : 19 Aug 2022 23:00 pm using AcqMethod FID17A.M  
Sample Name: L2240634-20,42,,  
Misc Info : WG1676467,WG1676456,ICAL18753

F1-Aliphatic  
JP-8  
L2240634-20  
Product

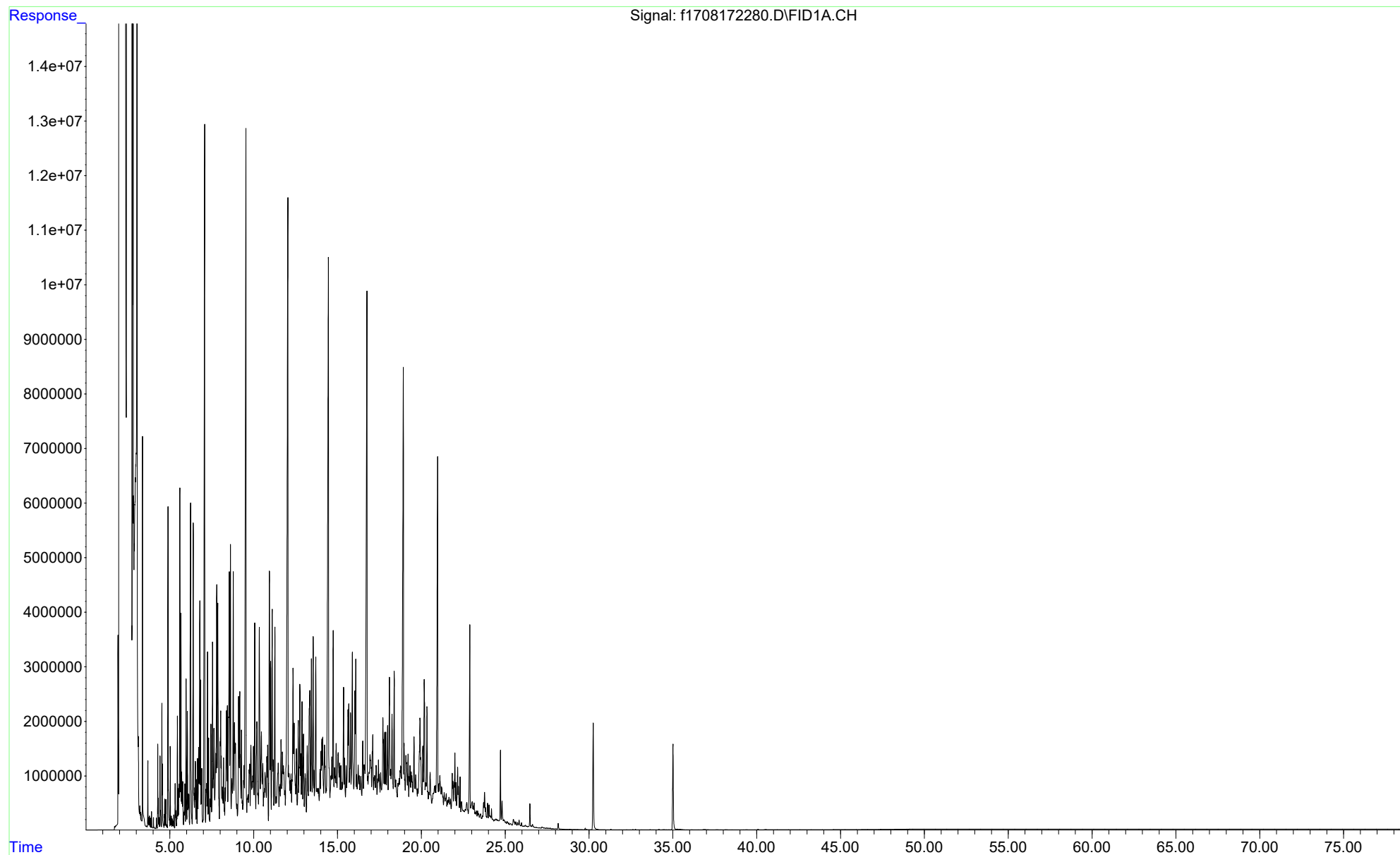

File :C:\Projects\Hawaii DOH\2. Laboratory Data\Alpha\Carbon Range  
... Study\L2240634\TPH\NF TPH\f1708172284.D  
Operator : FID17:WR  
Instrument : FID17  
Acquired : 20 Aug 2022 2:01 am using AcqMethod FID17A.M  
Sample Name: L2240634-26,42,,  
Misc Info : WG1676467,WG1676456,ICAL18753

F1-Aliphatic  
BUNKER C  
L2240634-26  
Product

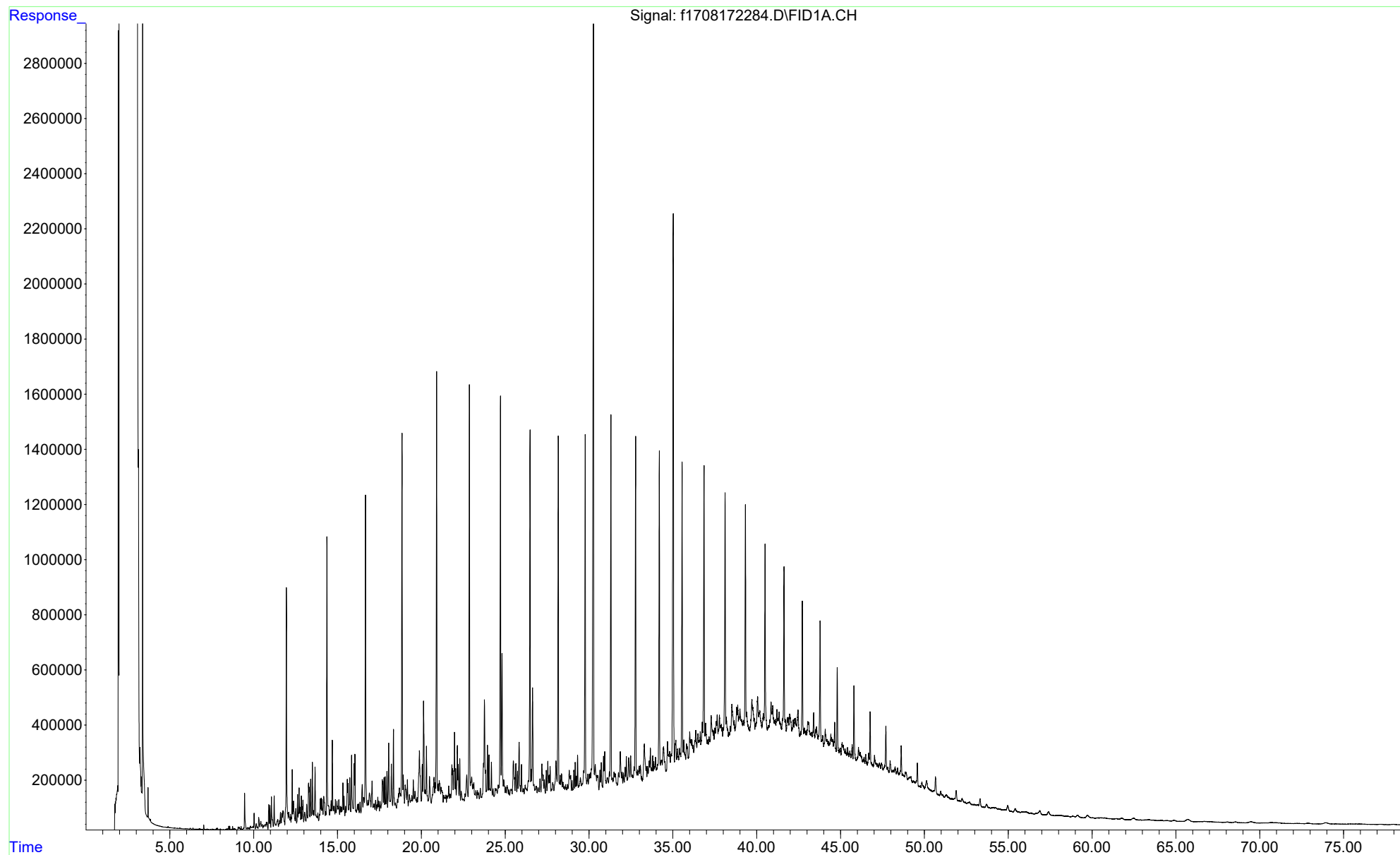

File :C:\Projects\Hawaii DOH\2. Laboratory Data\Alpha\Carbon Range  
... Study\L2240634\TPH\NF TPH\f1709062244.D  
Operator : FID17:WR  
Instrument : FID17  
Acquired : 07 Sep 2022 22:05 pm using AcqMethod FID17A.M  
Sample Name: L2240634-33,42,,  
Misc Info : WG1684077,WG1682989,ICAL18753

F1-Aliphatic  
WASTE OIL (AUTO) F1  
L2240634-33  
Product

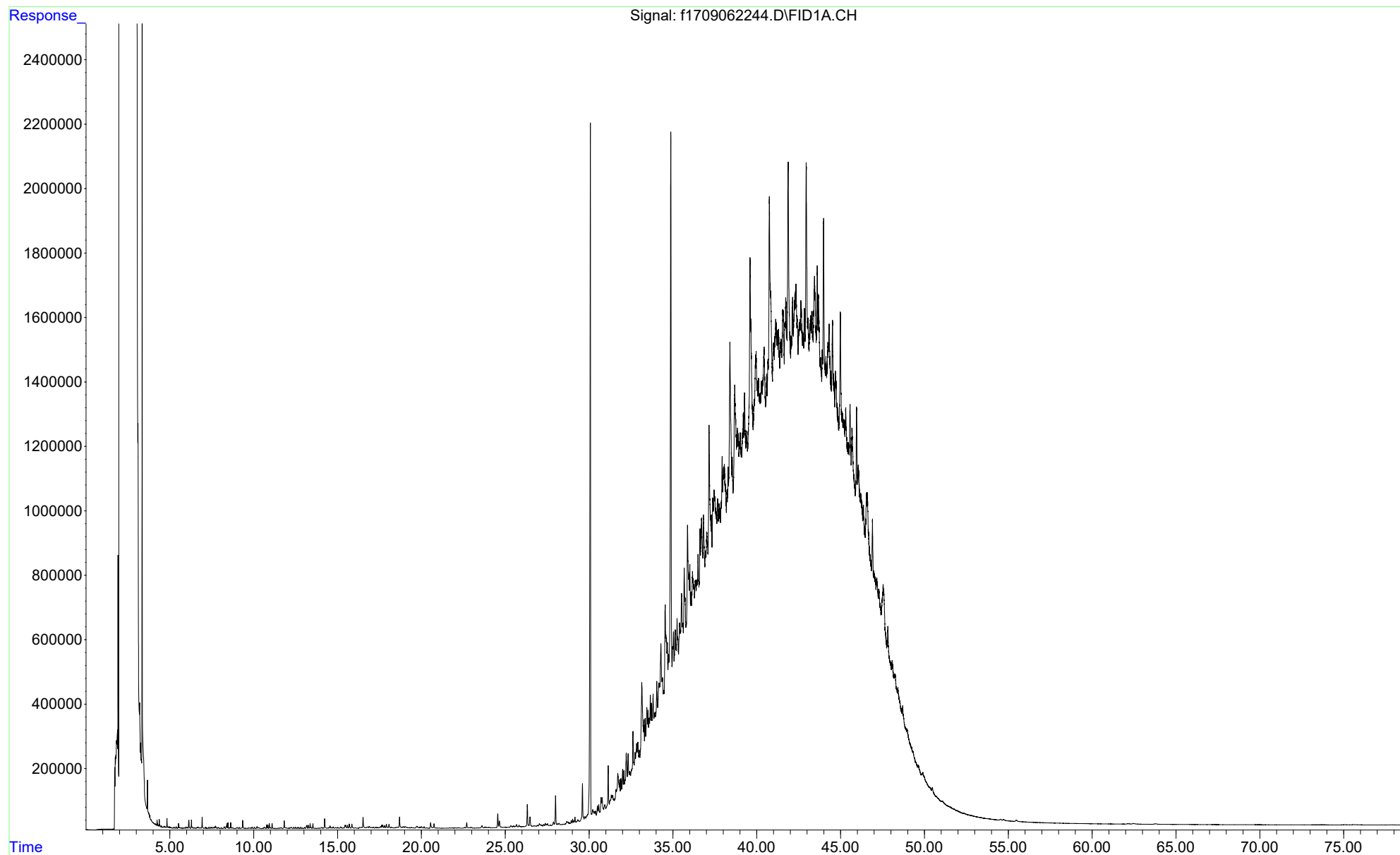

File :C:\Projects\Hawaii DOH\2. Laboratory Data\Alpha\Carbon Range  
... Study\L2240634\TPH\NF TPH\f1708172252.D  
Operator : FID17:WR  
Instrument : FID17  
Acquired : 19 Aug 2022 1:49 am using AcqMethod FID17A.M  
Sample Name: WG1676456-1,42,,  
Misc Info : WG1676467,WG1676456,ICAL18753

F1-Aliphatic  
Method Blank

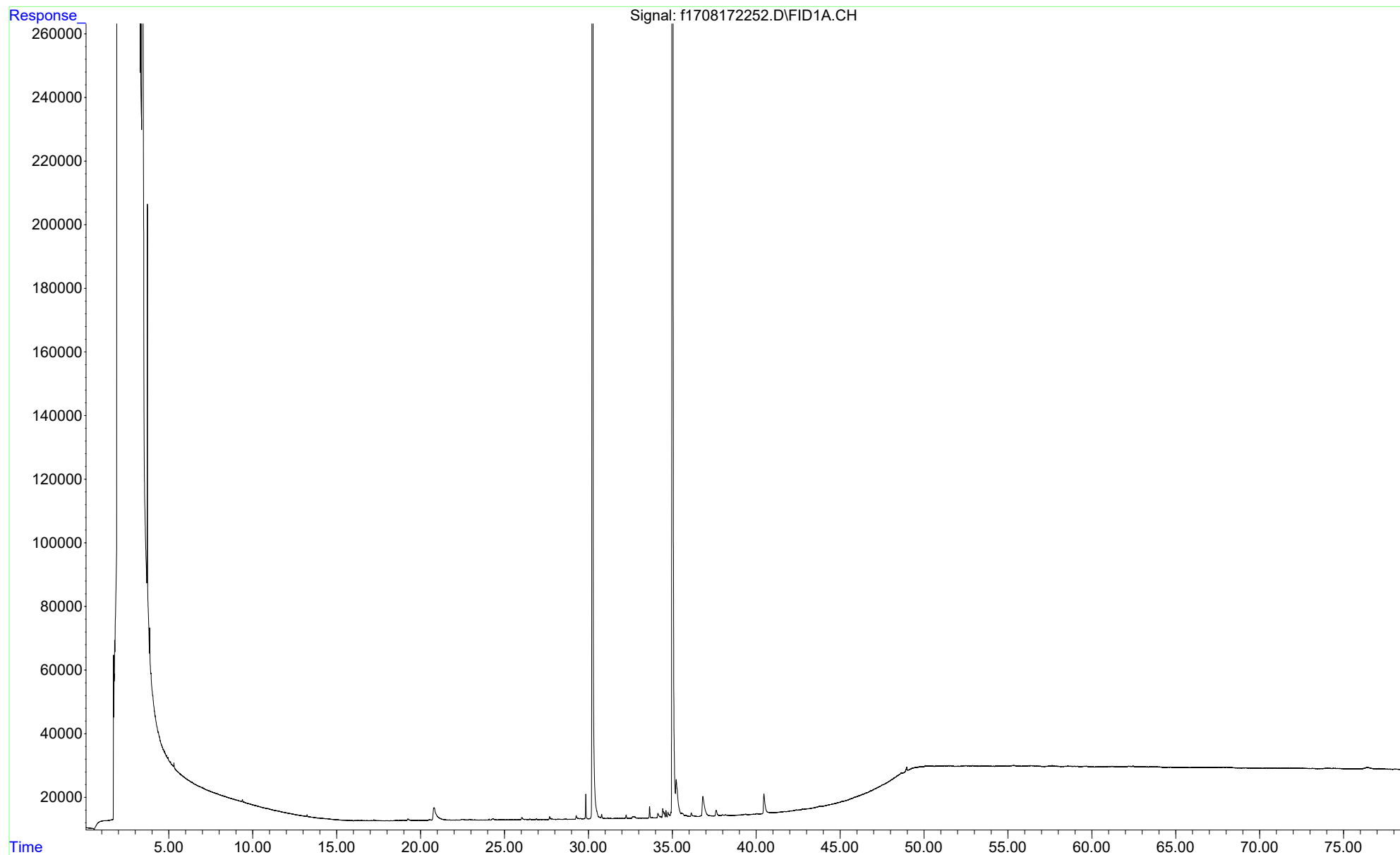

File :C:\Projects\Hawaii DOH\2. Laboratory Data\Alpha\Carbon Range  
... Study\L2240634\TPH\NF TPH\f1708172250.D  
Operator : FID17:WR  
Instrument : FID17  
Acquired : 19 Aug 2022 0:19 am using AcqMethod FID17A.M  
Sample Name: IB1708172203F  
Misc Info :

F1-Aliphatic  
Instrument Blank

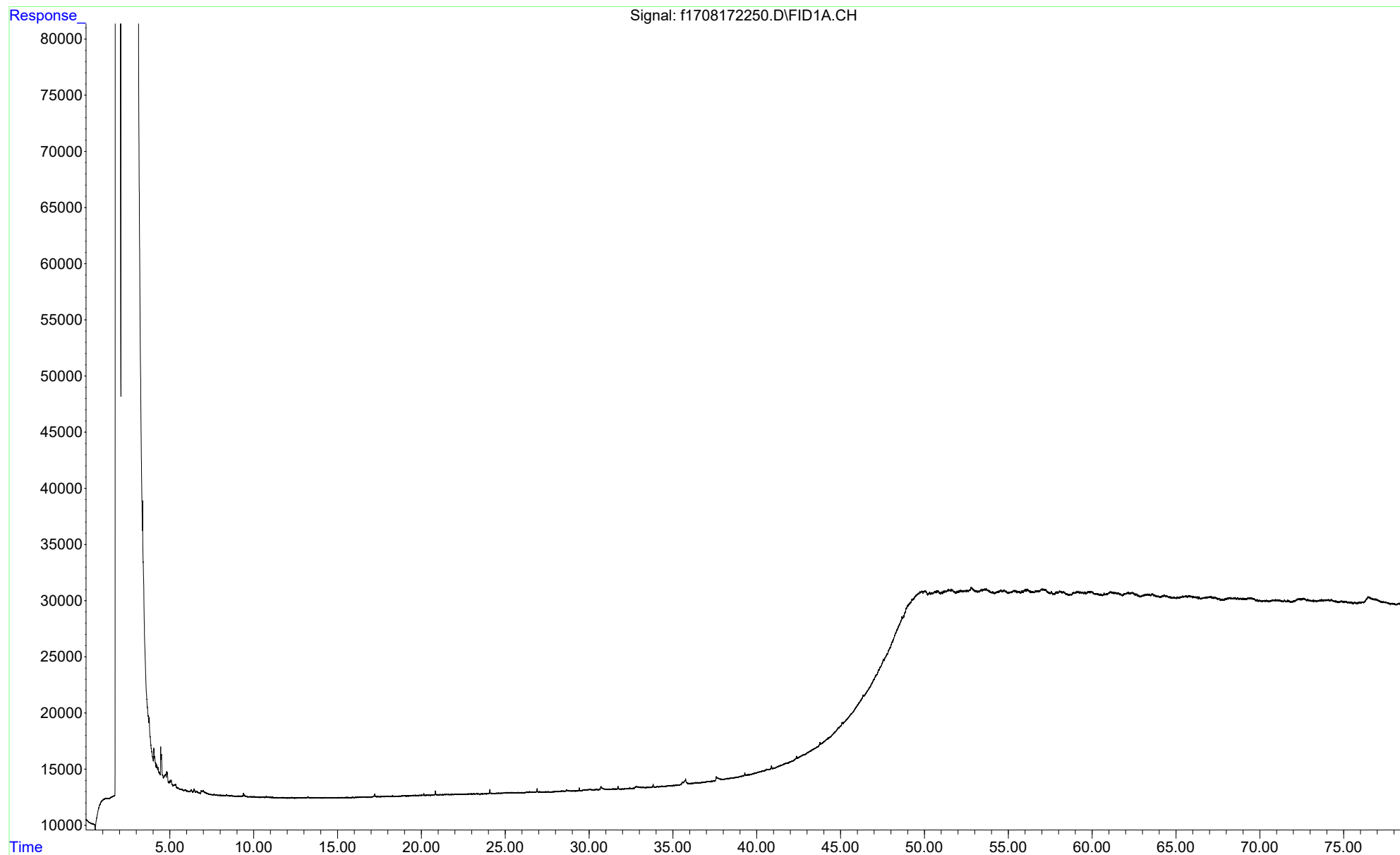

File :C:\Projects\Hawaii DOH\2. Laboratory Data\Alpha\Carbon Range  
... Study\L2240634\TPH\NF TPH\f1708172276.D  
Operator : FID17:WR  
Instrument : FID17  
Acquired : 19 Aug 2022 19:58 pm using AcqMethod FID17A.M  
Sample Name: IB1708172204F  
Misc Info :

F1-Aliphatic  
Instrument Blank

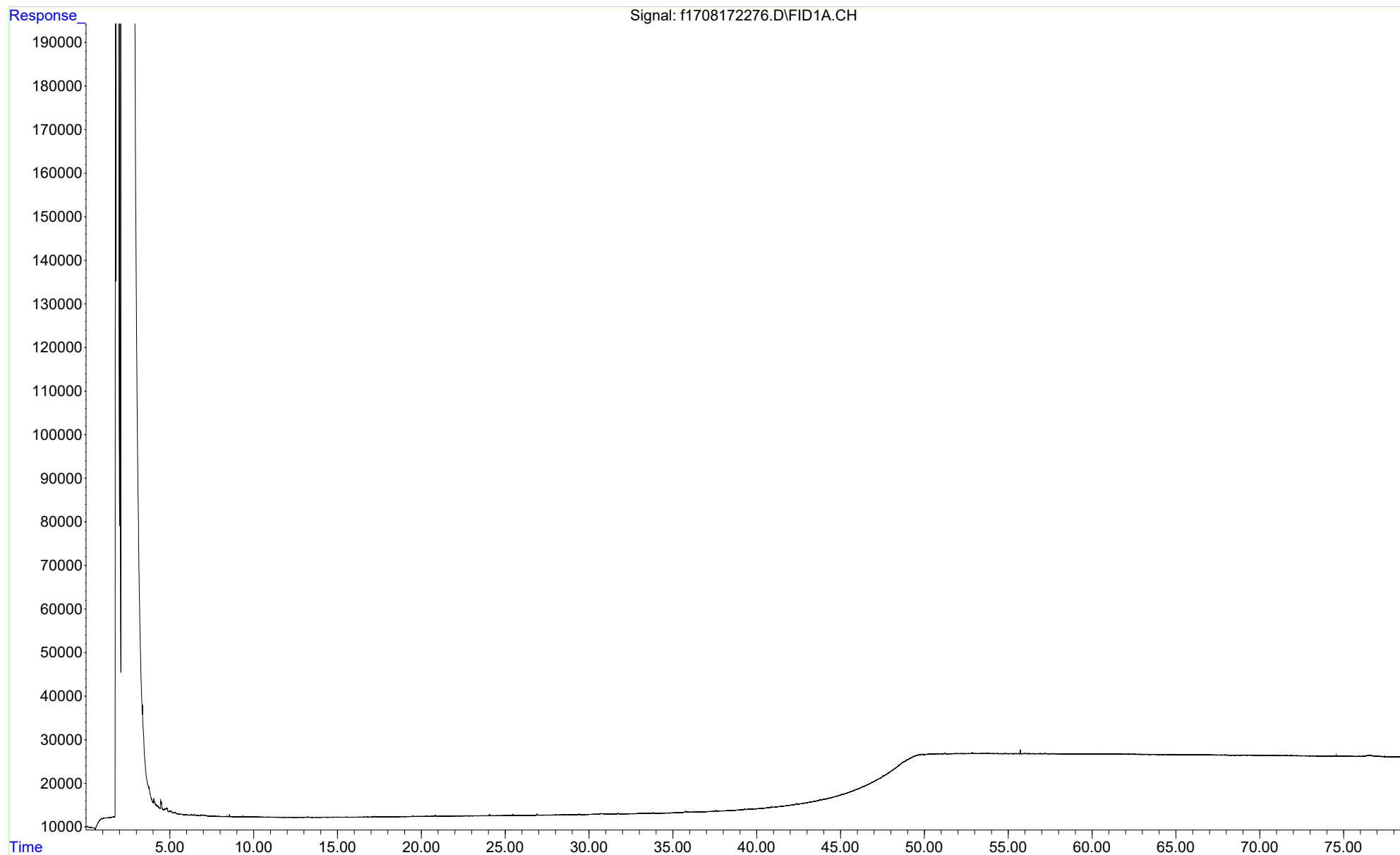



## Attachment D: FID Chromatograms Aromatic Fraction

File :C:\Projects\Hawaii DOH\2. Laboratory Data\Alpha\Carbon Range  
... Study\L2240634\TPH\Alpha TPH\f1708242224.D  
Operator : FID17:WR  
Instrument : FID17  
Acquired : 25 Aug 2022 19:02 pm using AcqMethod FID17A.M  
Sample Name: L2240634-03,42,,  
Misc Info : WG1679263,WG1676458,ICAL18753

F2-Aromatic  
GASOLINE 87 F2  
L2240634-03  
Product

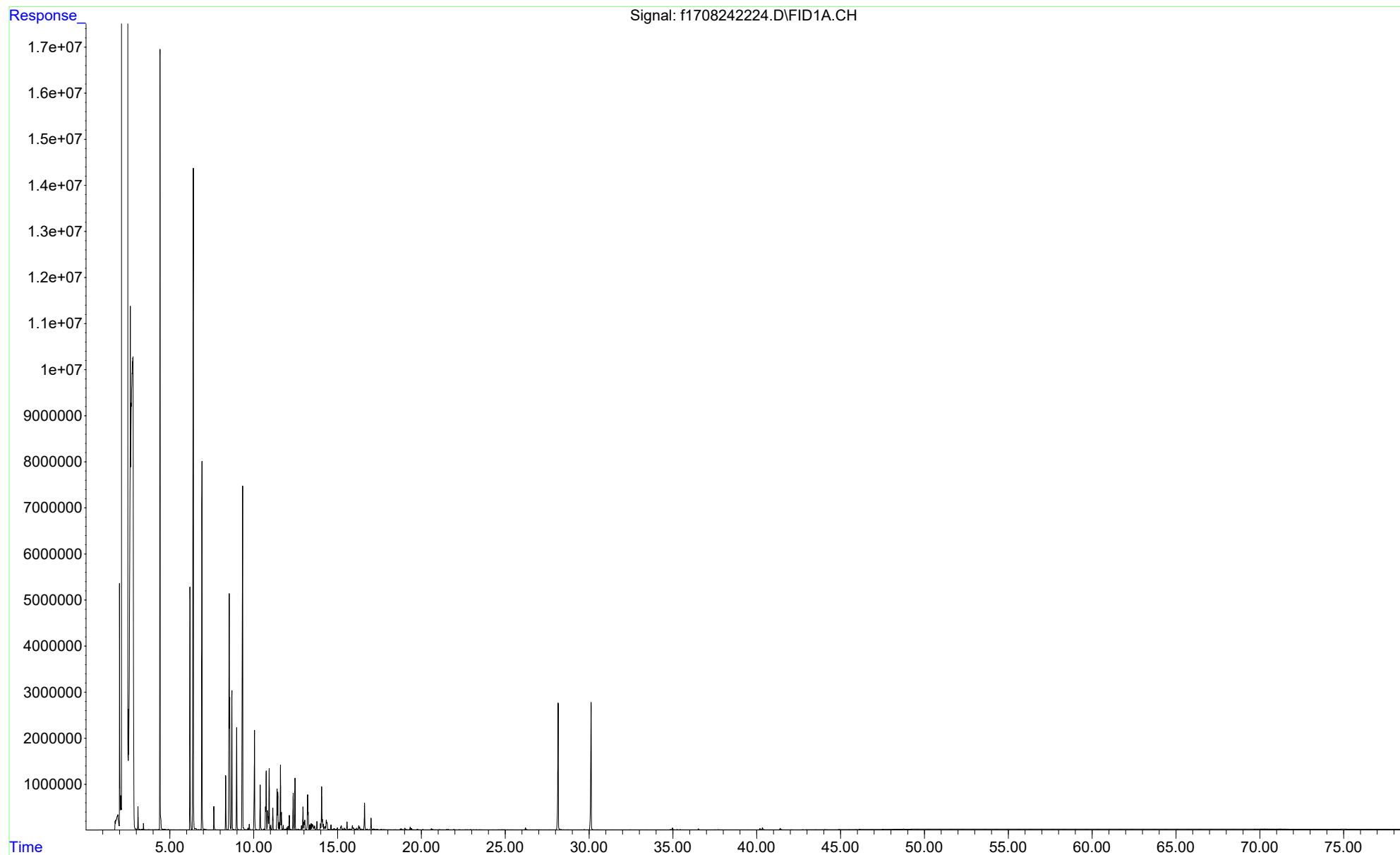

File :C:\Projects\Hawaii DOH\2. Laboratory Data\Alpha\Carbon Range  
... Study\L2240634\TPH\Alpha TPH\f1708242226.D  
Operator : FID17:WR  
Instrument : FID17  
Acquired : 25 Aug 2022 20:32 pm using AcqMethod FID17A.M  
Sample Name: WG1676458-4,42,,  
Misc Info : WG1679263,WG1676458,ICAL18753

F2-Aromatic  
GASOLINE 87 F2 Duplicate  
L2240634-03  
Product

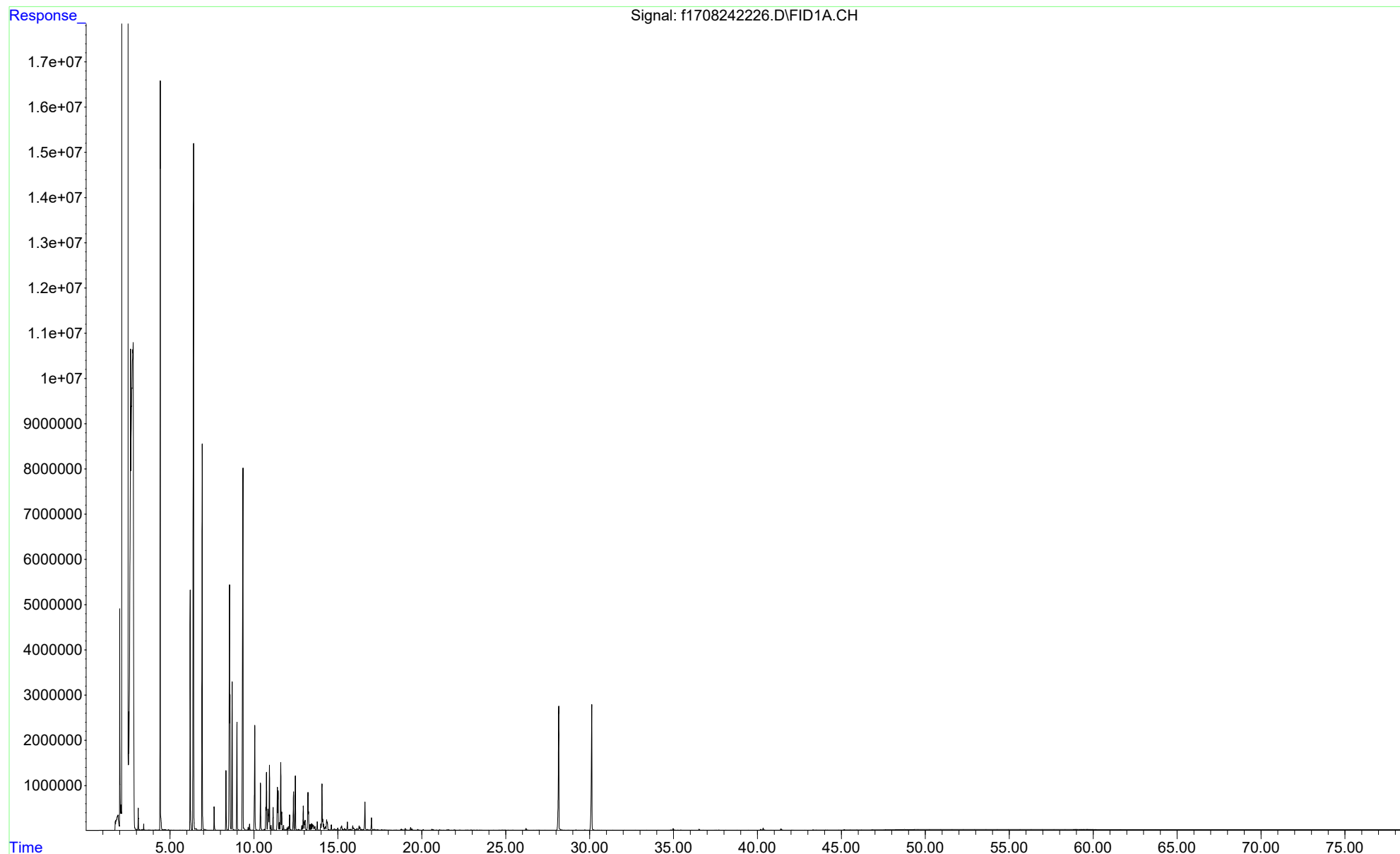

File :C:\Projects\Hawaii DOH\2. Laboratory Data\Alpha\Carbon Range  
... Study\L2240634\TPH\Alpha TPH\f1708242228.D  
Operator : FID17:WR  
Instrument : FID17  
Acquired : 25 Aug 2022 22:03 pm using AcqMethod FID17A.M  
Sample Name: L2240634-06,42,,  
Misc Info : WG1679263,WG1676458,ICAL18753

F2-Aromatic  
GASOLINE 91 F2  
L2240634-06  
Product

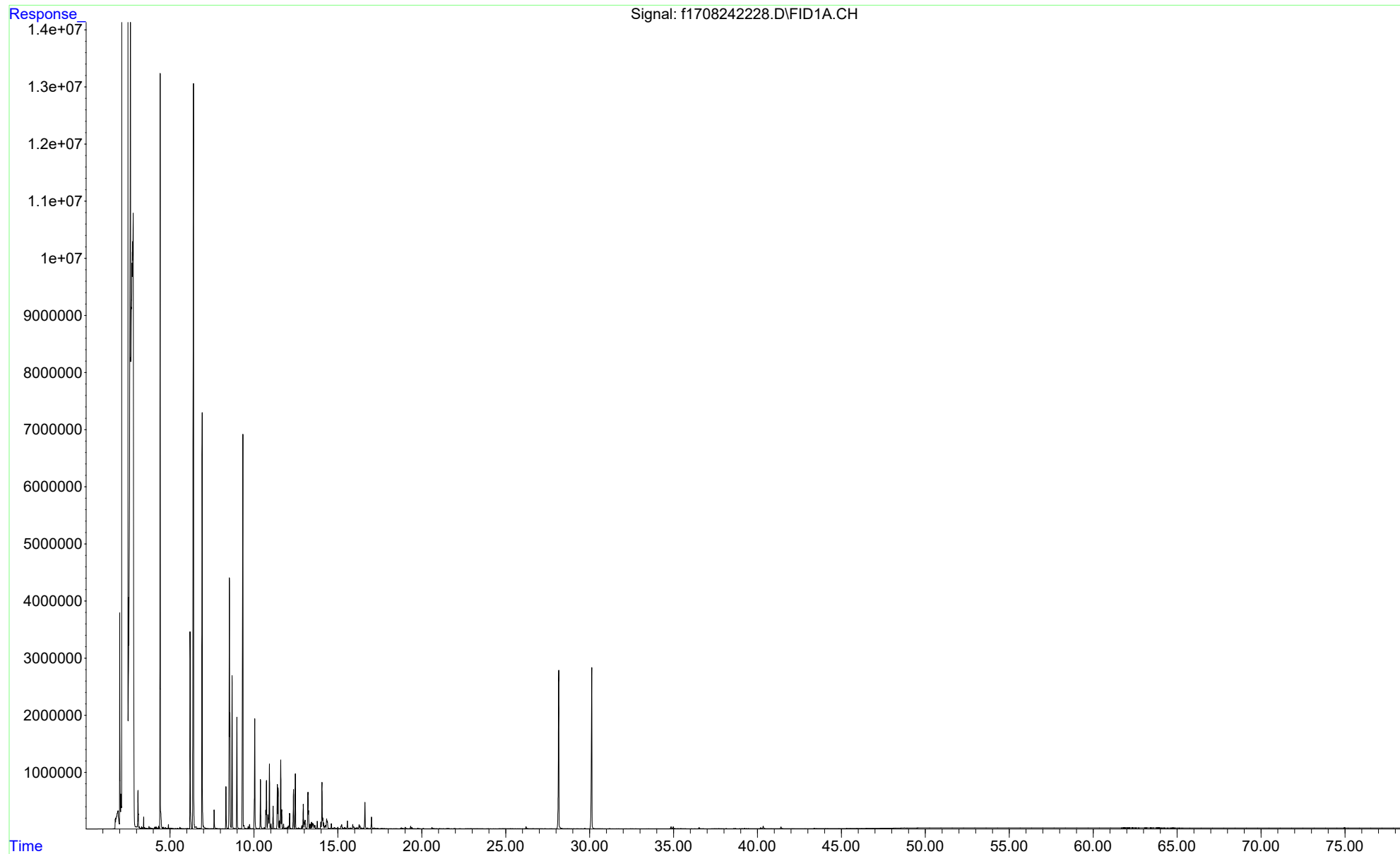

File :C:\Projects\Hawaii DOH\2. Laboratory Data\Alpha\Carbon Range  
... Study\L2240634\TPH\Alpha TPH\f1708242230.D  
Operator : FID17:WR  
Instrument : FID17  
Acquired : 25 Aug 2022 23:34 pm using AcqMethod FID17A.M  
Sample Name: L2240634-09,42,,  
Misc Info : WG1679263,WG1676458,ICAL18753

F2-Aromatic  
GASOLINE 93 F2  
L2240634-09  
Product

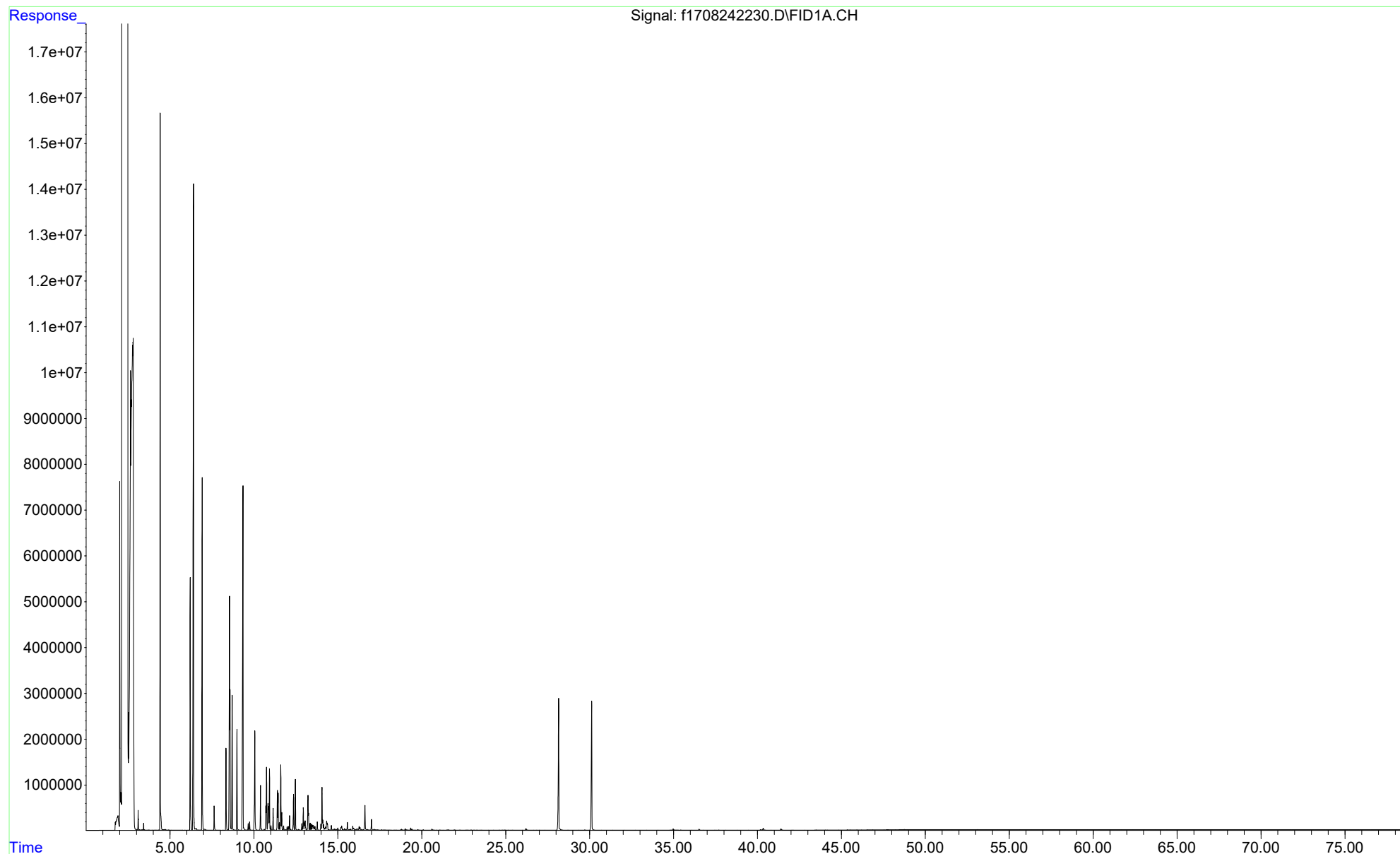

File :C:\Projects\Hawaii DOH\2. Laboratory Data\Alpha\Carbon Range  
... Study\L2240634\TPH\Alpha TPH\f1708242232.D  
Operator : FID17:WR  
Instrument : FID17  
Acquired : 26 Aug 2022 1:04 am using AcqMethod FID17A.M  
Sample Name: L2240634-12,42,,  
Misc Info : WG1679263,WG1676458,ICAL18753

F2-Aromatic  
HEATING FUEL F2  
L2240634-12  
Product

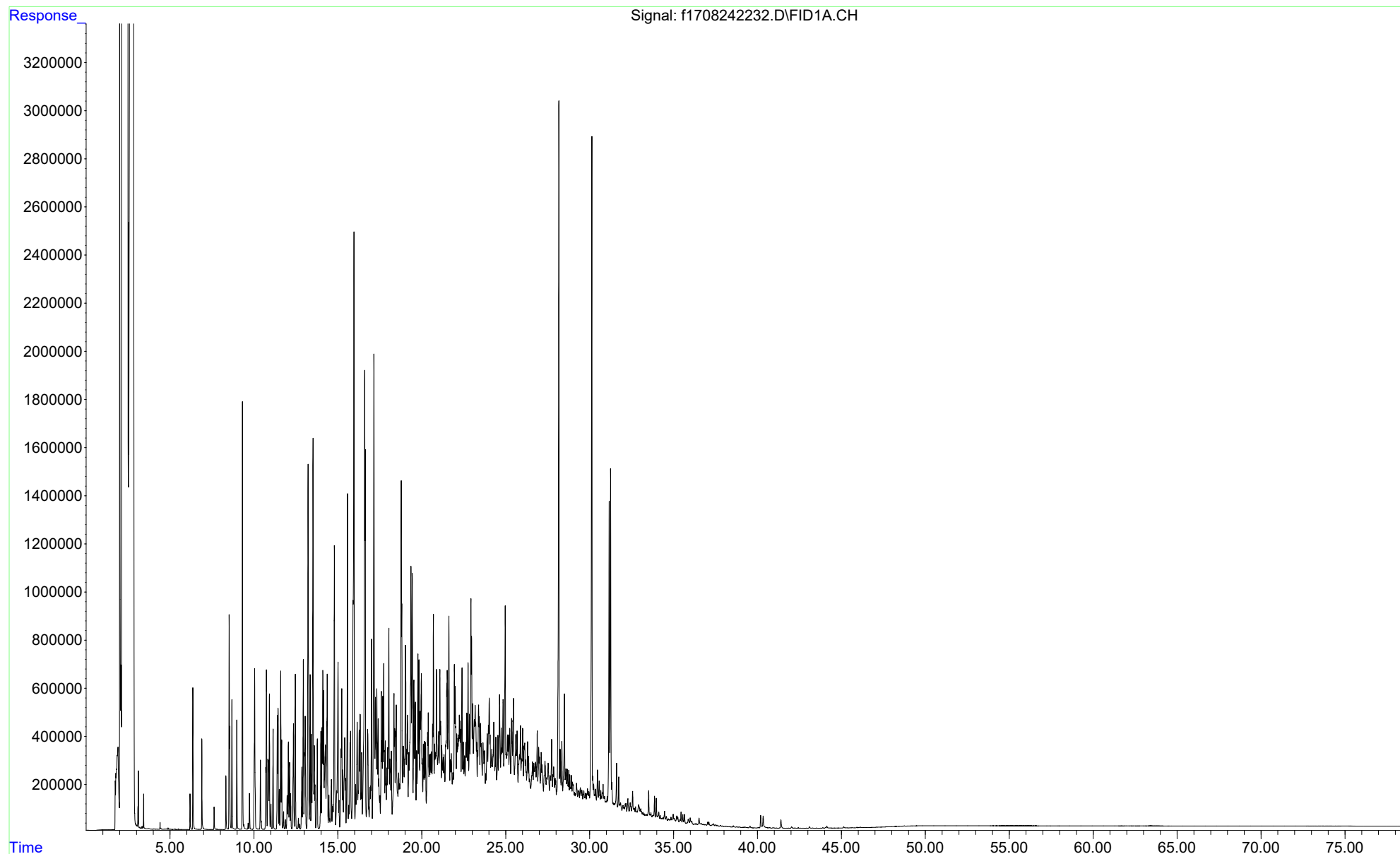

File :C:\Projects\Hawaii DOH\2. Laboratory Data\Alpha\Carbon Range  
... Study\L2240634\TPH\Alpha TPH\f1708242234.D  
Operator : FID17:WR  
Instrument : FID17  
Acquired : 26 Aug 2022 2:34 am using AcqMethod FID17A.M  
Sample Name: L2240634-15,42,,  
Misc Info : WG1679263,WG1676458,ICAL18753

F2-Aromatic  
ROAD DIESEL F2  
L2240634-15  
Product

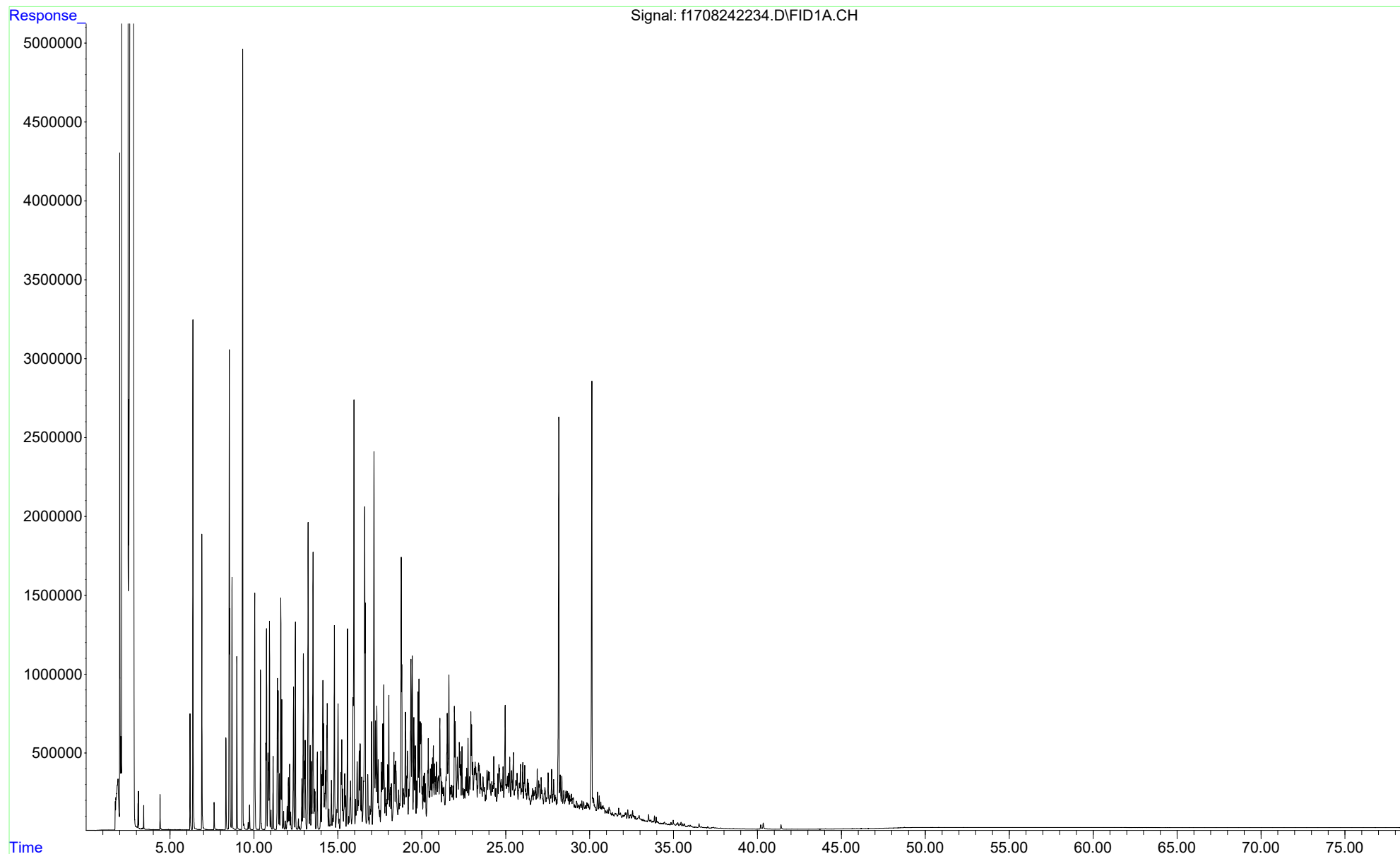

File :C:\Projects\Hawaii DOH\2. Laboratory Data\Alpha\Carbon Range  
... Study\L2240634\TPH\Alpha TPH\f1708242236.D  
Operator : FID17:WR  
Instrument : FID17  
Acquired : 26 Aug 2022 4:05 am using AcqMethod FID17A.M  
Sample Name: L2240634-18,42,,  
Misc Info : WG1679263,WG1676458,ICAL18753

F2-Aromatic  
JP-5 F2  
L2240634-18  
Product

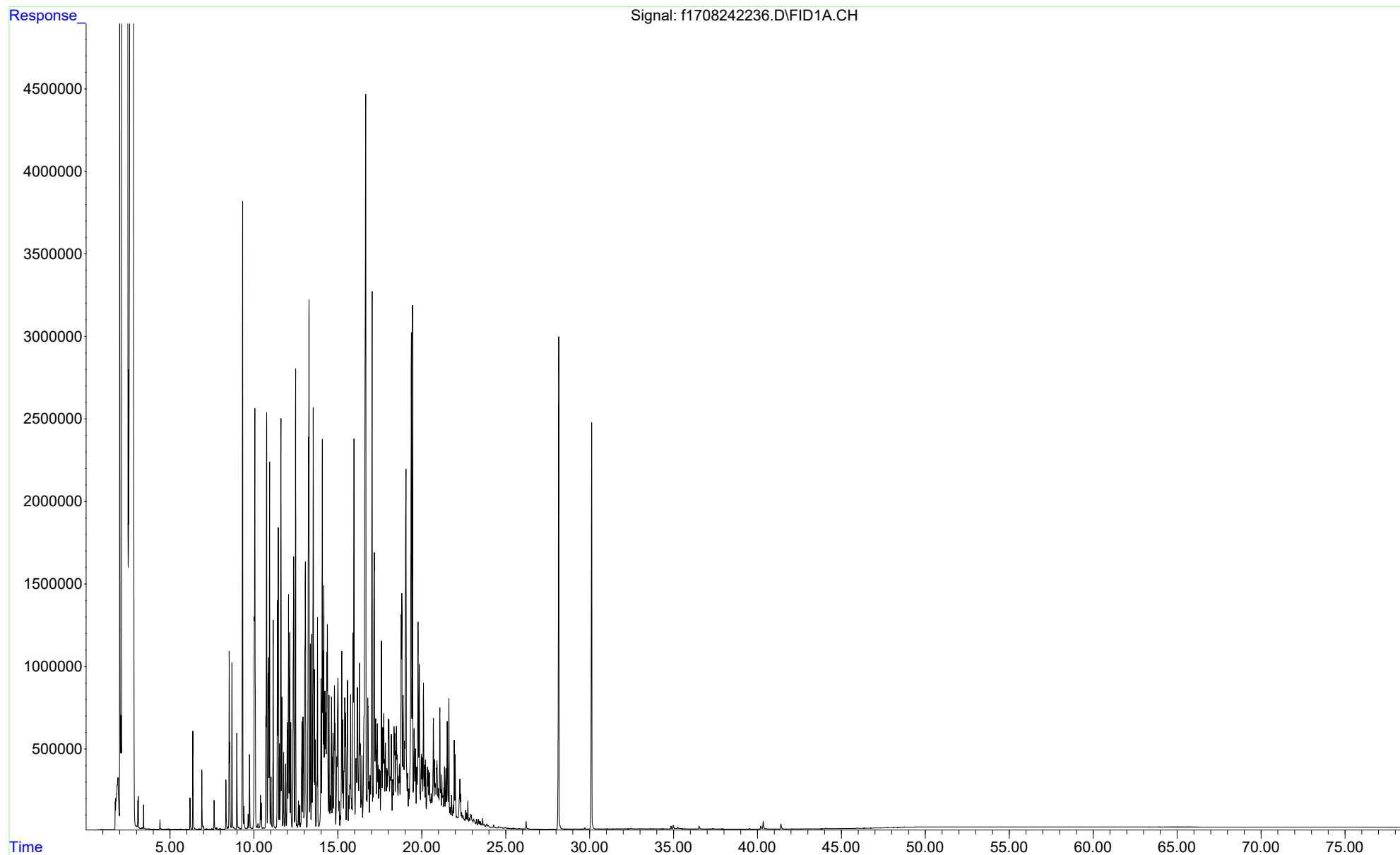



File :C:\Projects\Hawaii DOH\2. Laboratory Data\Alpha\Carbon Range  
... Study\L2240634\TPH\Alpha TPH\f1708242238.D  
Operator : FID17:WR  
Instrument : FID17  
Acquired : 26 Aug 2022 5:35 am using AcqMethod FID17A.M  
Sample Name: L2240634-21,42,,  
Misc Info : WG1679263,WG1676458,ICAL18753

F2-Aromatic  
JP-8 F2  
L2240634-21  
Product

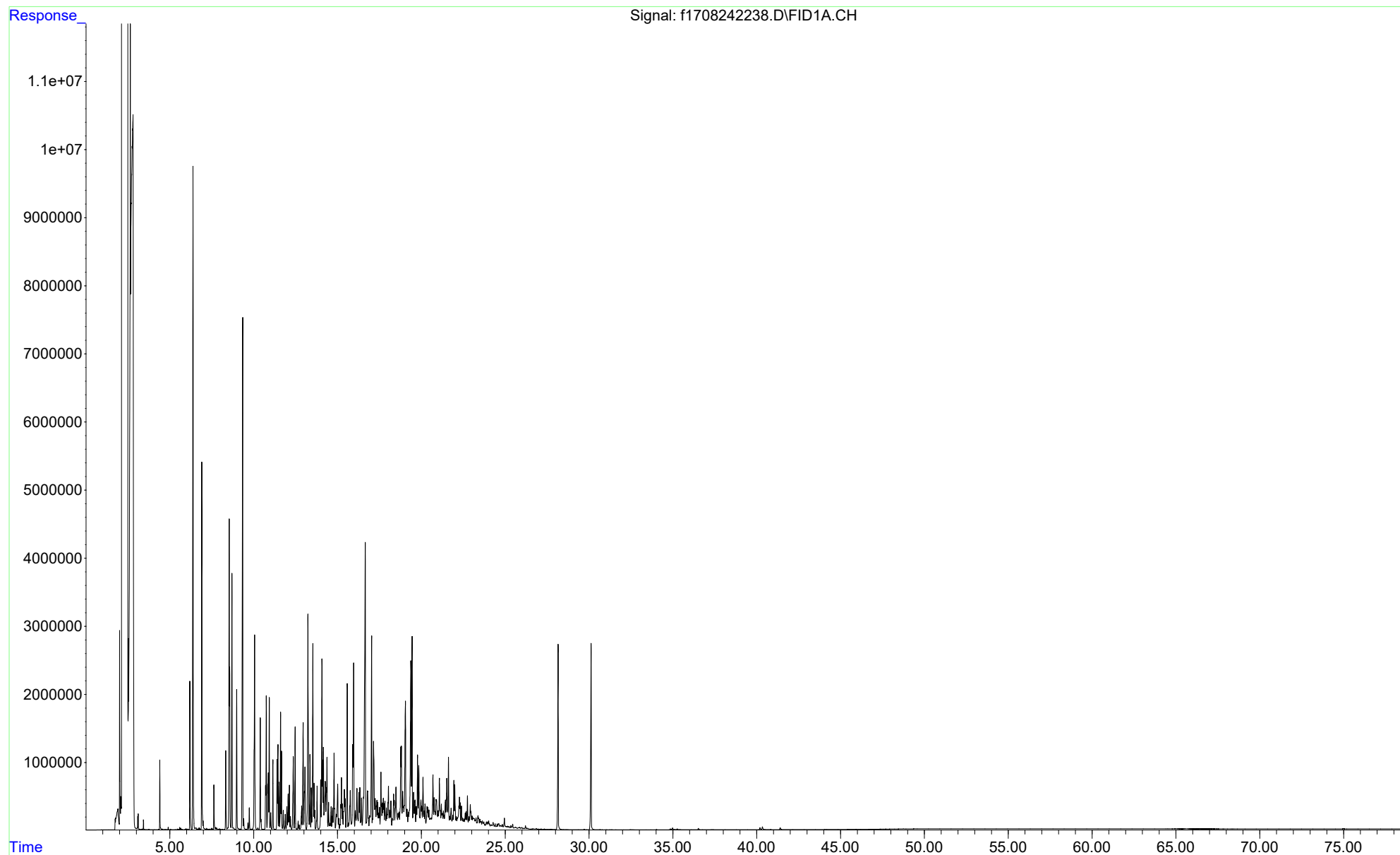

File :C:\Projects\Hawaii DOH\2. Laboratory Data\Alpha\Carbon Range  
... Study\L2240634\TPH\Alpha TPH\f1708242240.D  
Operator : FID17:WR  
Instrument : FID17  
Acquired : 26 Aug 2022 7:05 am using AcqMethod FID17A.M  
Sample Name: L2240634-27,42,,  
Misc Info : WG1679263,WG1676458,ICAL18753

F2-Aromatic  
BUNKER C F2  
L2240634-27  
Product

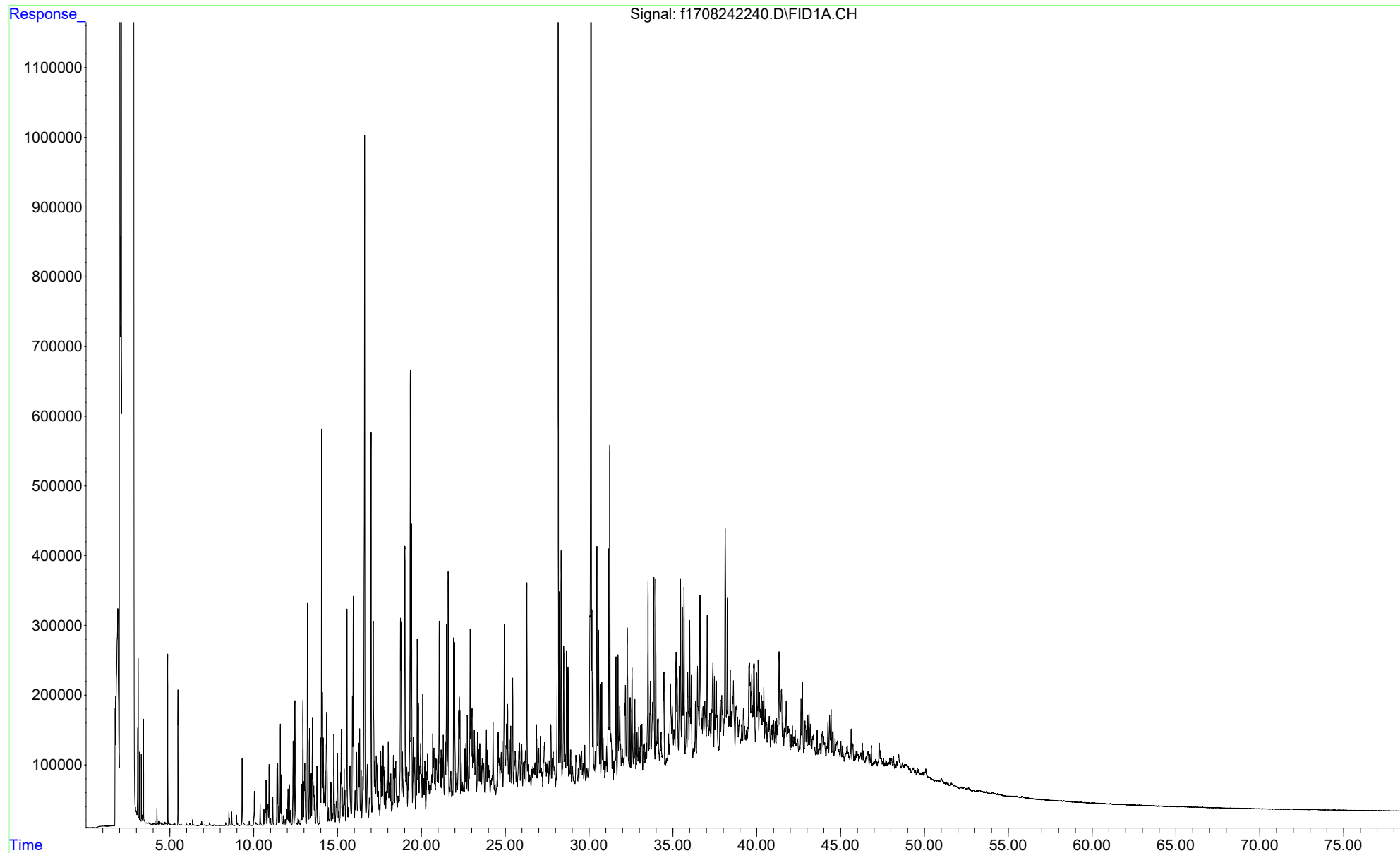

File :C:\Projects\Hawaii DOH\2. Laboratory Data\Alpha\Carbon Range  
... Study\L2240634\TPH\Alpha TPH\f1709062240.D  
Operator : FID17:WR  
Instrument : FID17  
Acquired : 07 Sep 2022 19:05 pm using AcqMethod FID17A.M  
Sample Name: L2240634-34,42,,  
Misc Info : WG1684077,WG1682993,ICAL18753

F2-Aromatic  
WASTE OIL (AUTO) F2  
L2240634-34  
Product

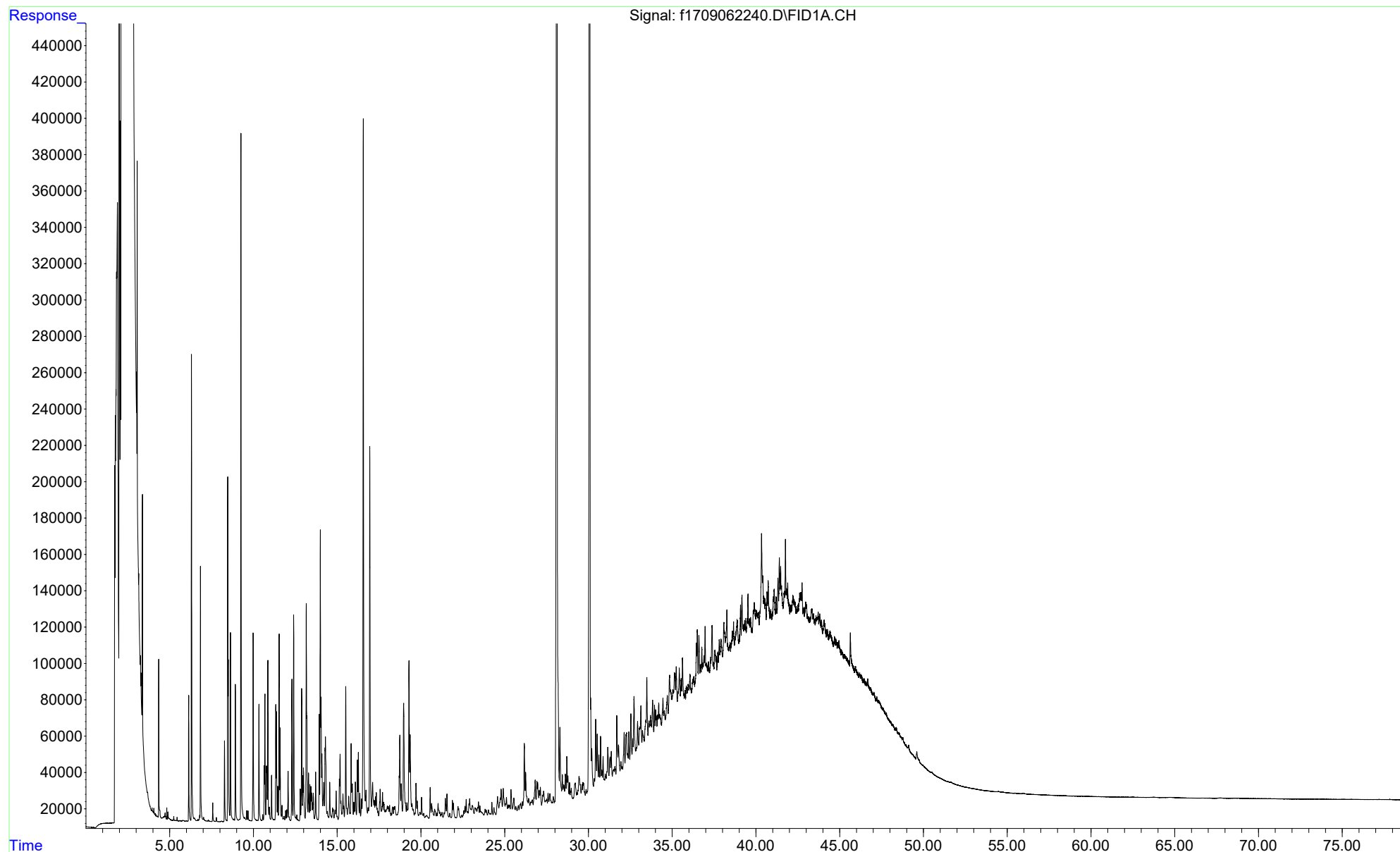

File :C:\Projects\Hawaii DOH\2. Laboratory Data\Alpha\Carbon Range  
... Study\L2240634\TPH\Alpha TPH\f1708242212.D  
Operator : FID17:WR  
Instrument : FID17  
Acquired : 25 Aug 2022 9:53 am using AcqMethod FID17A.M  
Sample Name: WG1676458-1,42,,  
Misc Info : WG1679263,WG1676458,ICAL18753

F2-Aromatic  
Method Blank

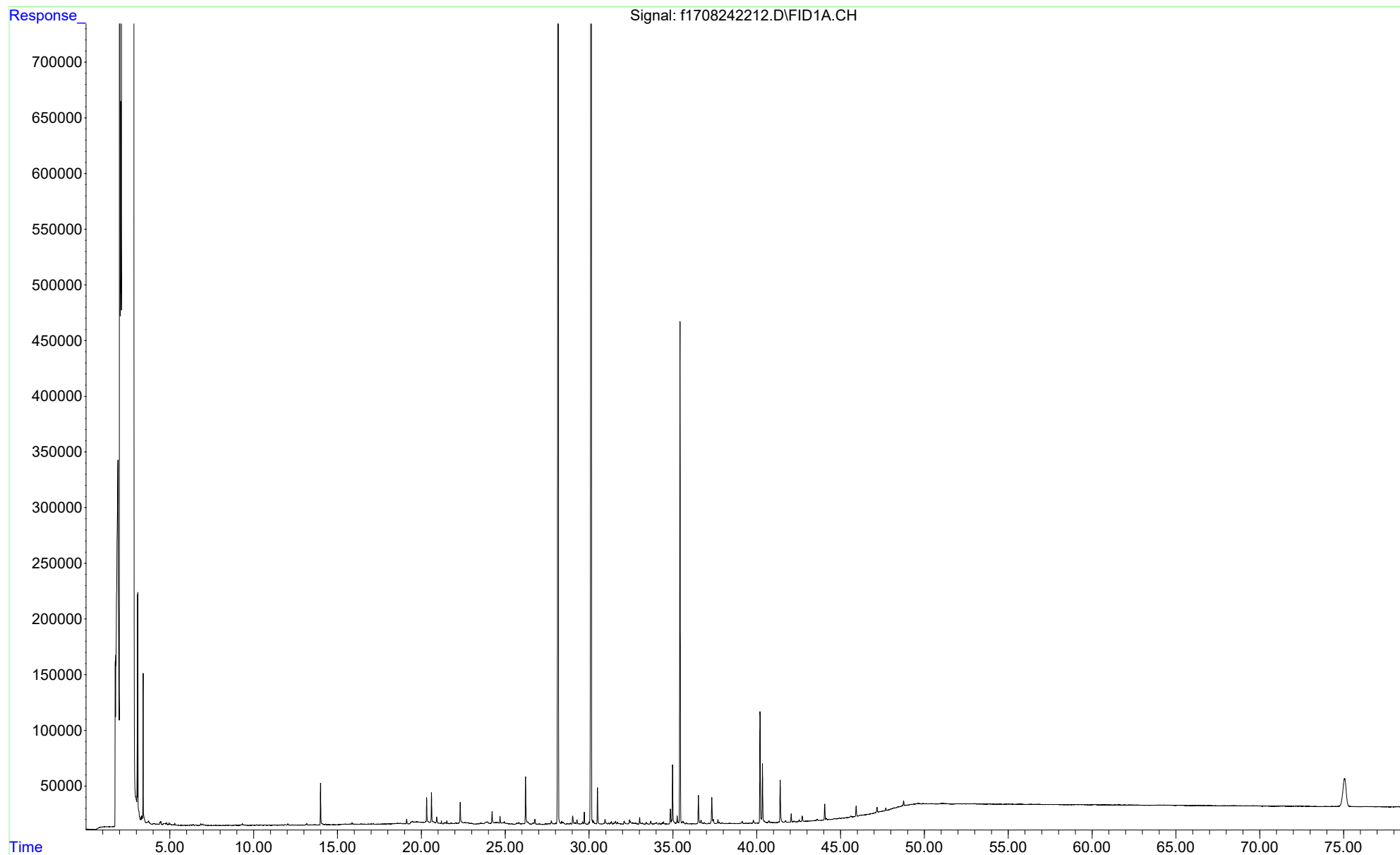

File :C:\Projects\Hawaii DOH\2. Laboratory Data\Alpha\Carbon Range  
... Study\L2240634\TPH\Alpha TPH\f1708242220.D  
Operator : FID17:WR  
Instrument : FID17  
Acquired : 25 Aug 2022 15:59 pm using AcqMethod FID17A.M  
Sample Name: IB1708242202F  
Misc Info :

F2-Aromatic  
Instrument Blank

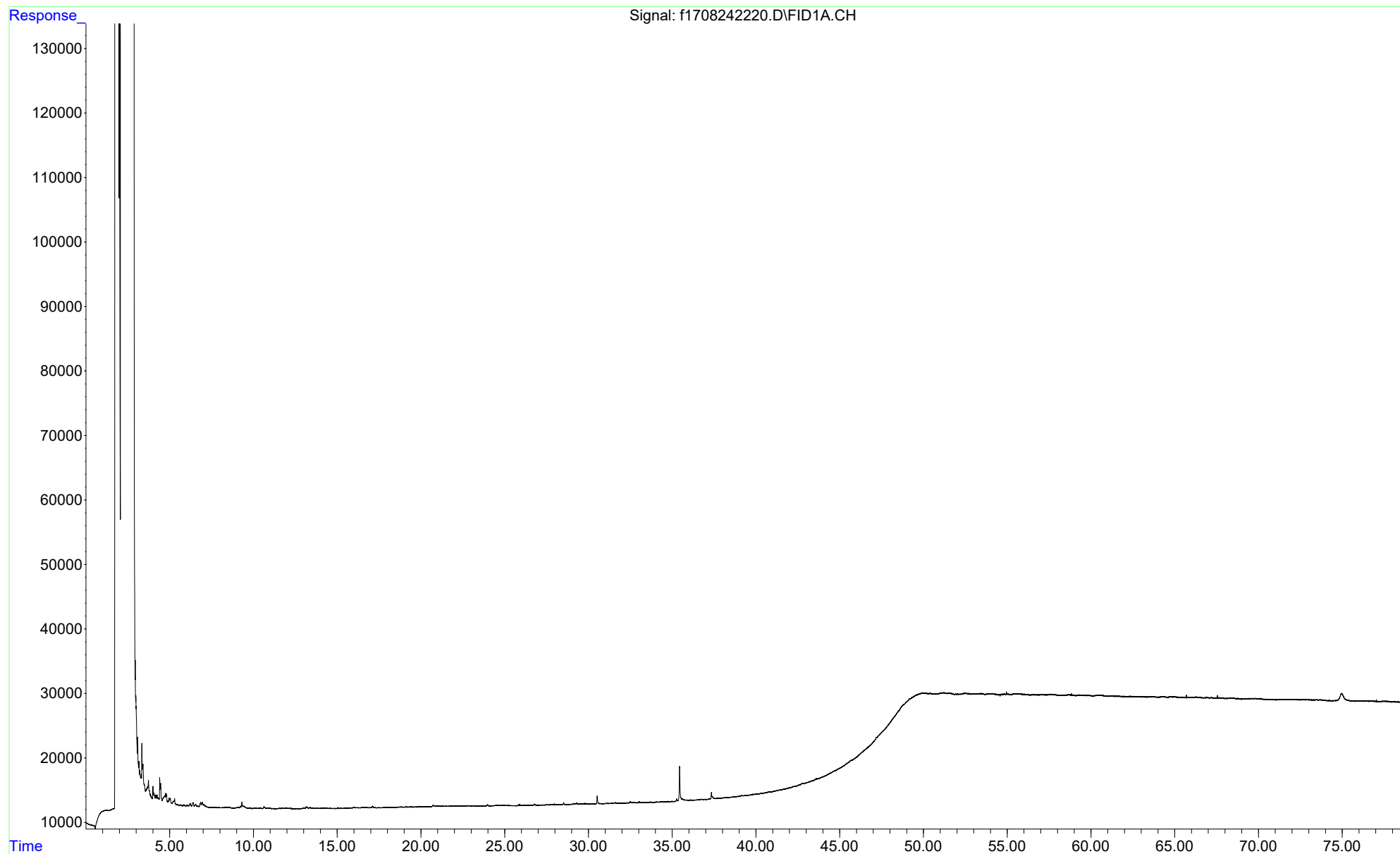

Attachment E: VPH Chromatograms and  
Quantification Reports

Quantitation Report (QT Reviewed)

Data Path : C:\Projects\Hawaii DOH\2. Laboratory Data\Alpha\Carbon Range Study\L2240634\VPH\NF Data\Aliphatic Dat:  
 Data File : P220902A05.D  
 Signal(s) : FID2B.ch  
 Acq On : 2 Sep 2022 11:00 am  
 Operator : PVPH:BAD  
 Sample : WG1684889-4,41,10,1,0.100,,  
 Misc : WG1684889,ICAL19300,VPH-50  
 ALS Vial : 5 Sample Multiplier: 1

Integration File: autoint1.e  
 Quant Time: Sep 16 09:08:53 2022  
 Quant Method : C:\Projects\Aquiver Hawaii\2. Laboratory Data\Alpha\Carbon Range Study\L2240634\VPH\NF Data\NF Ali  
 ... .09152022.m  
 Quant Title : VPH ALIPHATIC  
 QLast Update : Fri Sep 16 09:02:50 2022  
 Response via : Initial Calibration  
 Integrator: ChemStation

Volume Inj. :  
 Signal Phase :  
 Signal Info :

Compound	R.T.	Response	Conc	Units
System Monitoring Compounds				
8) s 2,5-Dibromotoluene-FID	22.455	10942410	270.693	
Spiked Amount	250.000	Recovery = 108.28%		
Target Compounds				
9) A1 C5-C8 Aliphatics	5.404f	30443172	270.398	m
10) A2 C5 - C6 Aliphatics	5.626f	9158246	81.344	m
11) A2 > C6 - C8 Aliphatics	7.578f	4966763	44.115	m
12) A1 > C8-C10 Aliphatics	13.678	1462338	11.735	m
13) A2 C8 - C10 Aliphatics	13.678	1419622	11.392	m
14) A2 > C10 - C12 Aliphatics	18.050f	3457053	27.742	m

(f)=RT Delta > 1/2 Window (m)=manual int.

Quantitation Report (QT Reviewed)

Data Path : C:\Projects\Hawaii DOH\2. Laboratory Data\Alpha\Carbon Range Study\L2240634\VPH\NF Data\Aliphatic Da  
Data File : P220902A05.D  
Signal(s) : FID2B.ch  
Acq On : 2 Sep 2022 11:00 am  
Operator : PVPH:BAD  
Sample : WG1684889-4,41,10,1,0.100,,  
Misc : WG1684889,ICAL19300,VPH-50  
ALS Vial : 5 Sample Multiplier: 1

Integration File: autoint1.e  
Quant Time: Sep 16 09:08:53 2022  
Quant Method : C:\Projects\Aquiver Hawaii\2. Laboratory Data\Alpha\Carbon Range Study\L2240634\VPH\NF Data\NF A  
... .09152022.m  
Quant Title : VPH ALIPHATIC  
QLast Update : Fri Sep 16 09:02:50 2022  
Response via : Initial Calibration  
Integrator: ChemStation

Volume Inj. :  
Signal Phase :  
Signal Info :

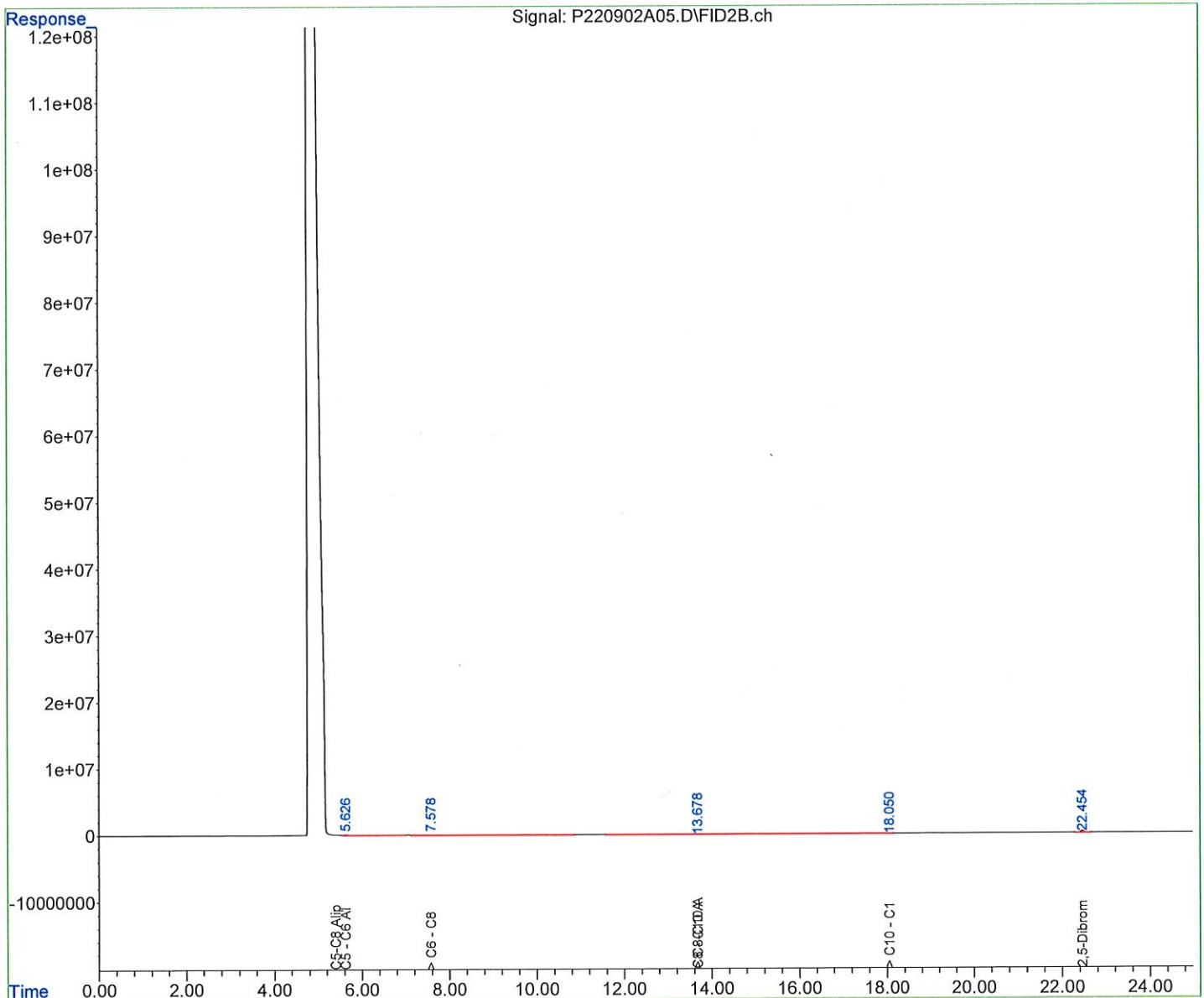



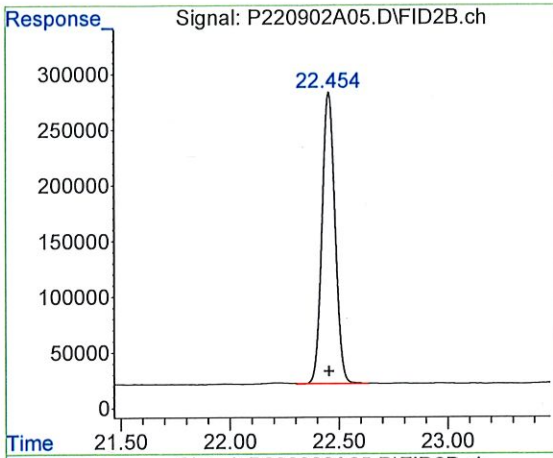

#8 2,5-Dibromotoluene-FID

R.T.: 22.455 min  
 Delta R.T.: 0.001 min  
 Response: 10942410  
 Conc: 270.69

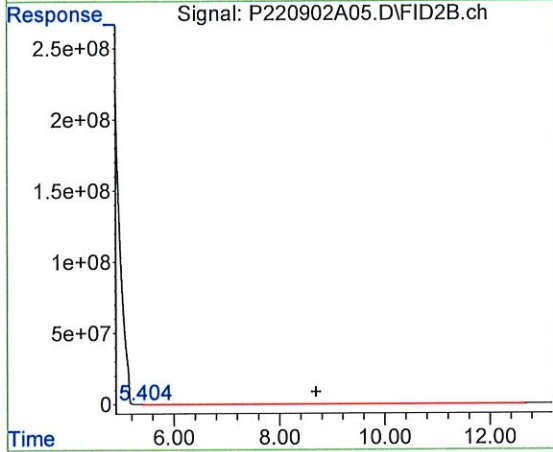

#9 C5-C8 Aliphatics

R.T.: 5.404 min  
 Delta R.T.: -3.290 min  
 Response: 30443172  
 Conc: 270.40 m

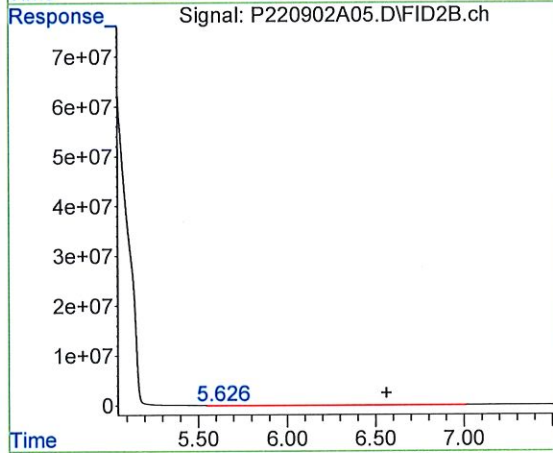

#10 C5 - C6 Aliphatics

R.T.: 5.626 min  
 Delta R.T.: -0.935 min  
 Response: 9158246  
 Conc: 81.34 m

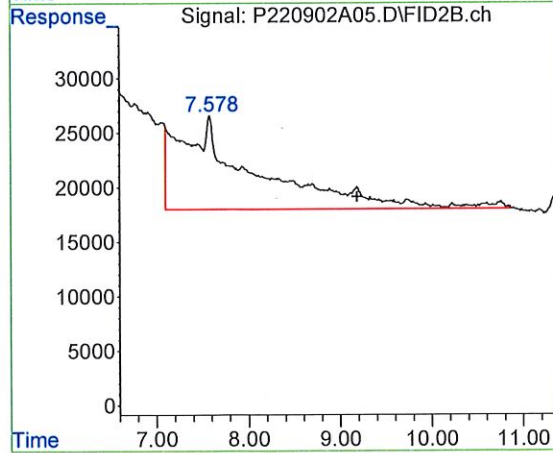

#11 > C6 - C8 Aliphatics

R.T.: 7.578 min  
 Delta R.T.: -1.608 min  
 Response: 4966763  
 Conc: 44.11 m

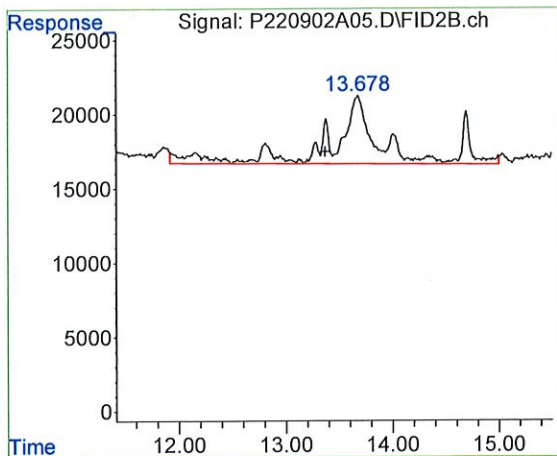

#12 > C8-C10 Aliphatics

R.T.: 13.678 min  
Delta R.T.: 0.307 min  
Response: 1462338  
Conc: 11.74 m

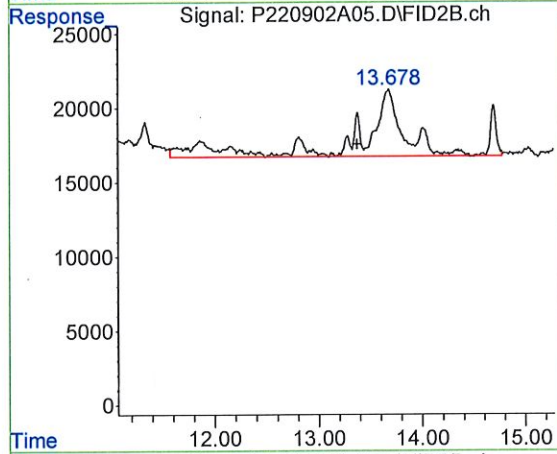

#13 C8 - C10 Aliphatics

R.T.: 13.678 min  
Delta R.T.: 0.304 min  
Response: 1419622  
Conc: 11.39 m

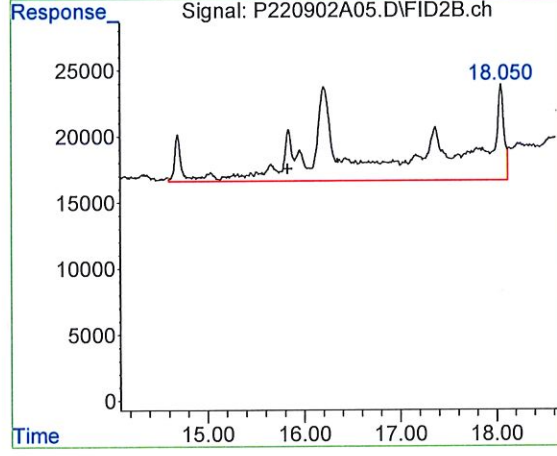

#14 > C10 - C12 Aliphatics

R.T.: 18.050 min  
Delta R.T.: 2.220 min  
Response: 3457053  
Conc: 27.74 m

Quantitation Report (QT Reviewed)

Data Path : C:\Projects\Hawaii DOH\2. Laboratory Data\Alpha\Carbon Range Study\L2240634\VPH\NF Data\Aliphatic Dat  
Data File : P220902A21.D  
Signal(s) : FID2B.ch  
Acq On : 2 Sep 2022 7:24 pm  
Operator : PVPH:BAD  
Sample : I2240634-01d,41,10,1.11,0.0002,,w  
Misc : WG1684889,ICAL19300,VPH-50  
ALS Vial : 21 Sample Multiplier: 1

Integration File: autoint1.e  
Quant Time: Oct 20 12:41:34 2022  
Quant Method : C:\Projects\Aquiver Hawaii\2. Laboratory Data\Alpha\Carbon Range Study\L2240634\VPH\NF Data\NF Ali  
... .09152022.m  
Quant Title : VPH ALIPHATIC  
QLast Update : Fri Sep 16 09:02:50 2022  
Response via : Initial Calibration  
Integrator: ChemStation

Volume Inj. :  
Signal Phase :  
Signal Info :

Compound	R.T.	Response	Conc	Units
----------	------	----------	------	-------

System Monitoring Compounds

Target Compounds

9) A1 C5-C8 Aliphatics	11.330f	304347979	2703.231	m
10) A2 C5 - C6 Aliphatics	5.656f	60440510	536.835	m
11) A2 > C6 - C8 Aliphatics	9.189	121166480	1076.206	m
12) A1 > C8-C10 Aliphatics	11.330f	255768658	2052.512	m
13) A2 C8 - C10 Aliphatics	11.330f	254301055	2040.735	m
14) A2 > C10 - C12 Aliphatics	15.830	74746720	599.833	m

(f)=RT Delta > 1/2 Window

(m)=manual int.

Quantitation Report (QT Reviewed)

Data Path : C:\Projects\Hawaii DOH\2. Laboratory Data\Alpha\Carbon Range Study\L2240634\VPH\NF Data\Aliphatic Da  
Data File : P220902A21.D  
Signal(s) : FID2B.ch  
Acq On : 2 Sep 2022 7:24 pm  
Operator : PVPH:BAD  
Sample : I2240634-01d,41,10,1.11,0.0002,,w  
Misc : WG1684889,ICAL19300,VPH-50  
ALS Vial : 21 Sample Multiplier: 1

Integration File: autoint1.e  
Quant Time: Oct 20 12:41:34 2022  
Quant Method : C:\Projects\Aquiver Hawaii\2. Laboratory Data\Alpha\Carbon Range Study\L2240634\VPH\NF Data\NF A  
... .09152022.m  
Quant Title : VPH ALIPHATIC  
QLast Update : Fri Sep 16 09:02:50 2022  
Response via : Initial Calibration  
Integrator: ChemStation

Volume Inj. :  
Signal Phase :  
Signal Info :

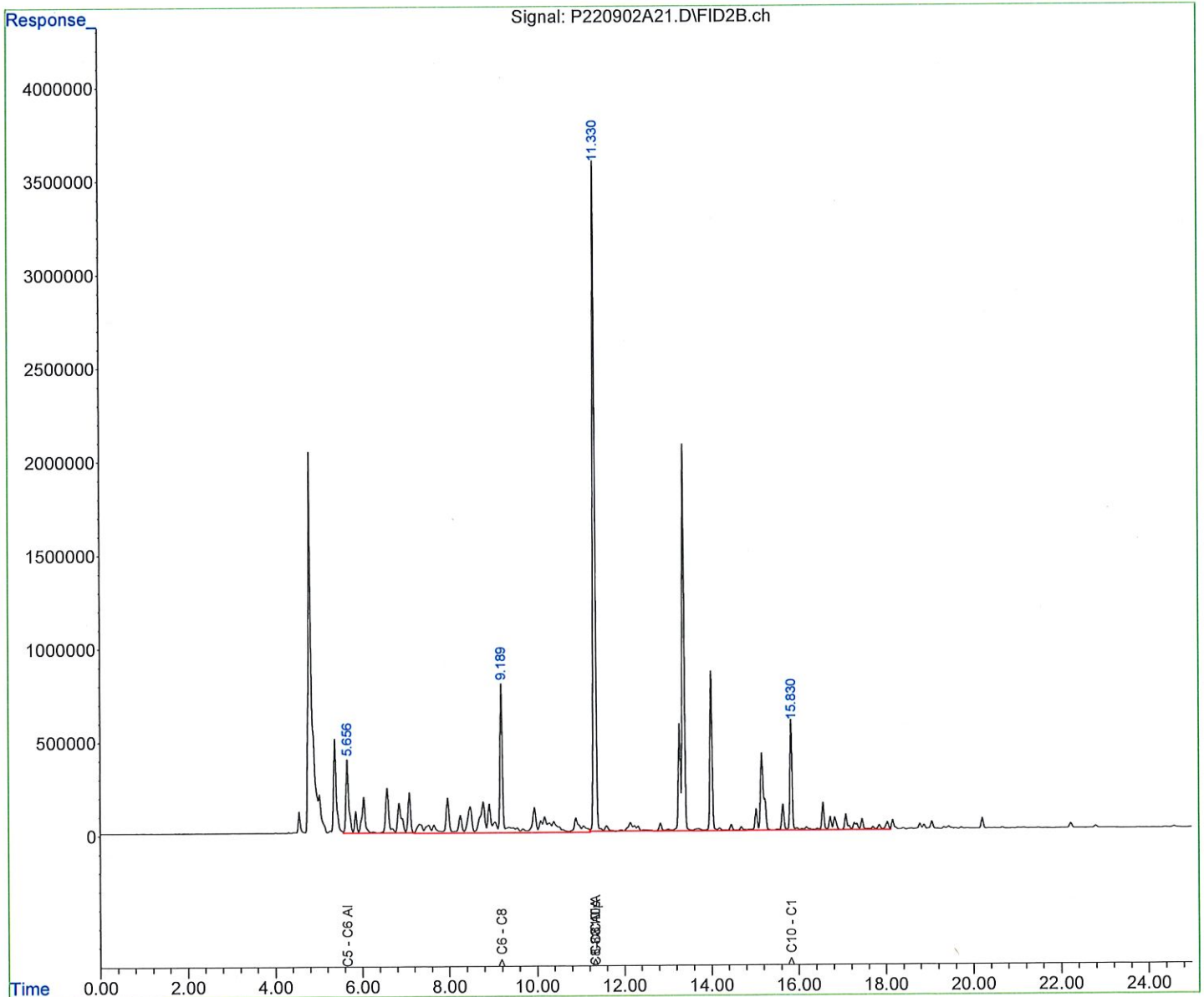

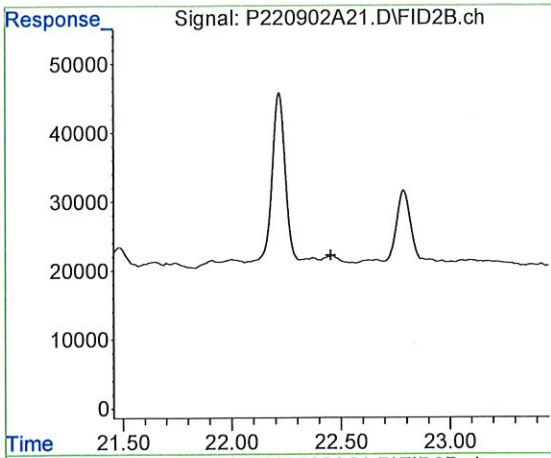

#8 2,5-Dibromotoluene-FID  
 R.T.: 0.000 min  
 Exp R.T. : 22.454 min  
 Response: 0  
 Conc: N.D.

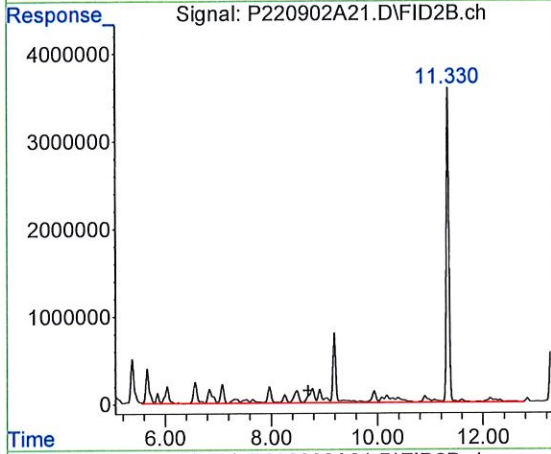

#9 C5-C8 Aliphatics  
 R.T.: 11.330 min  
 Delta R.T.: 2.636 min  
 Response: 304347979  
 Conc: 2703.23 m

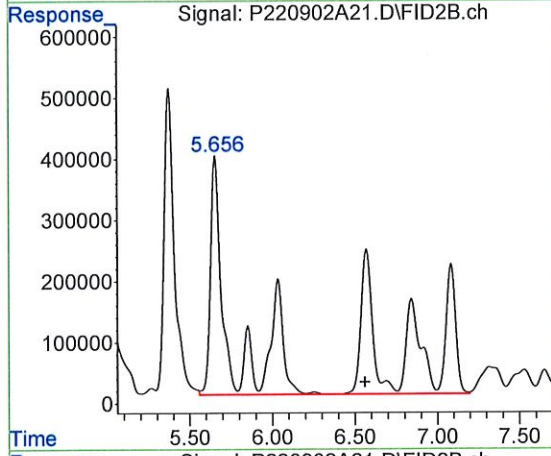

#10 C5 - C6 Aliphatics  
 R.T.: 5.656 min  
 Delta R.T.: -0.905 min  
 Response: 60440510  
 Conc: 536.84 m

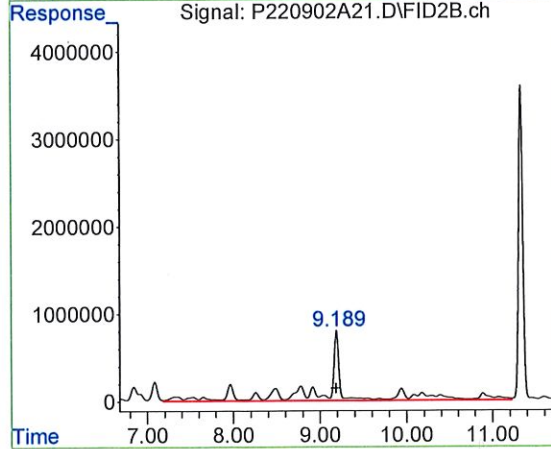

#11 > C6 - C8 Aliphatics  
 R.T.: 9.189 min  
 Delta R.T.: 0.003 min  
 Response: 121166480  
 Conc: 1076.21 m

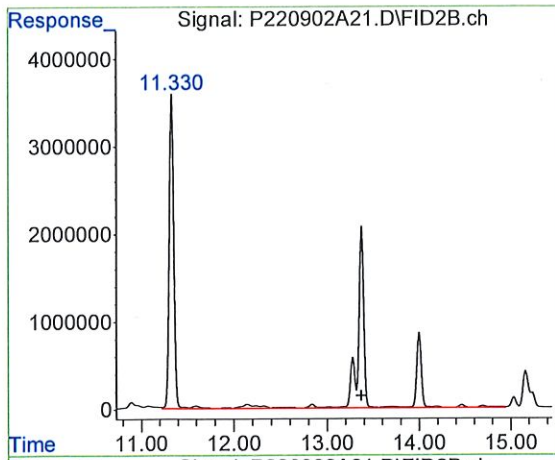

#12 > C8-C10 Aliphatics

R.T.: 11.330 min  
 Delta R.T.: -2.041 min  
 Response: 255768658  
 Conc: 2052.51 m

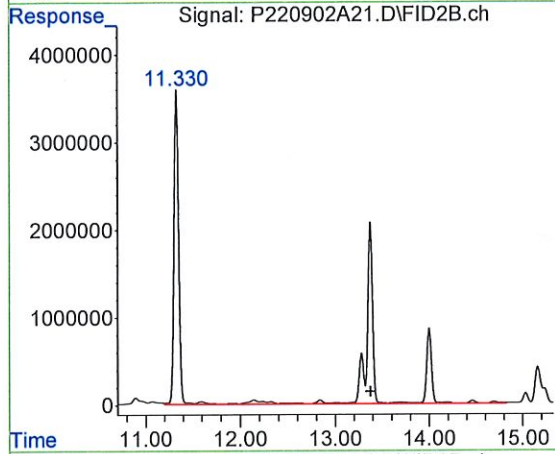

#13 C8 - C10 Aliphatics

R.T.: 11.330 min  
 Delta R.T.: -2.044 min  
 Response: 254301055  
 Conc: 2040.73 m

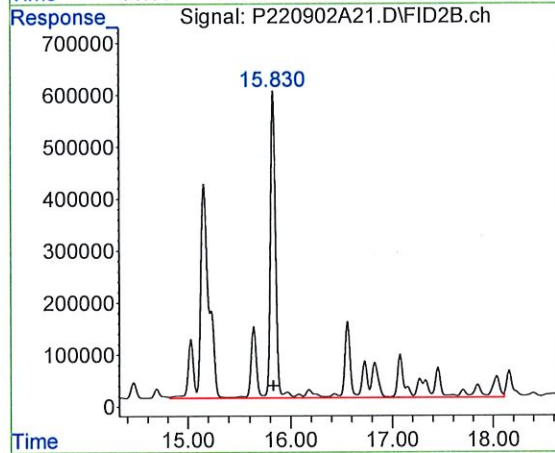

#14 > C10 - C12 Aliphatics

R.T.: 15.830 min  
 Delta R.T.: 0.000 min  
 Response: 74746720  
 Conc: 599.83 m

Quantitation Report (QT Reviewed)

Data Path : C:\Projects\Hawaii DOH\2. Laboratory Data\Alpha\Carbon Range Study\L2240634\VPH\NF Data\Aliphatic Data  
Data File : P220902A23.D  
Signal(s) : FID2B.ch  
Acq On : 2 Sep 2022 8:24 pm  
Operator : PVPH:BAD  
Sample : WG1684889-6,41,10,1.11,0.0002,,w  
Misc : WG1684889,ICAL19300,VPH-50  
ALS Vial : 23 Sample Multiplier: 1

Integration File: autoint1.e  
Quant Time: Sep 16 13:35:50 2022  
Quant Method : C:\Projects\Aquiver Hawaii\2. Laboratory Data\Alpha\Carbon Range Study\L2240634\VPH\NF Data\NF Ali  
... .09152022.m  
Quant Title : VPH ALIPHATIC  
QLast Update : Fri Sep 16 09:02:50 2022  
Response via : Initial Calibration  
Integrator: ChemStation

Volume Inj. :  
Signal Phase :  
Signal Info :

Compound	R.T.	Response	Conc	Units
----------	------	----------	------	-------

System Monitoring Compounds

Target Compounds

9) A1 C5-C8 Aliphatics	11.330f	300192561	2666.323	m
10) A2 C5 - C6 Aliphatics	5.655f	61735358	548.336	m
11) A2 > C6 - C8 Aliphatics	9.189	107967308	958.970	m
12) A1 > C8-C10 Aliphatics	11.330f	251296740	2016.626	m
13) A2 C8 - C10 Aliphatics	11.330f	250868515	2013.189	m
14) A2 > C10 - C12 Aliphatics	15.830	70683996	567.230	m

(f)=RT Delta > 1/2 Window

(m)=manual int.

Quantitation Report (QT Reviewed)

Data Path : C:\Projects\Hawaii DOH\2. Laboratory Data\Alpha\Carbon Range Study\L2240634\VPH\NF Data\Aliphatic Da  
Data File : P220902A23.D  
Signal(s) : FID2B.ch  
Acq On : 2 Sep 2022 8:24 pm  
Operator : PVPH:BAD  
Sample : WG1684889-6,41,10,1.11,0.0002,,w  
Misc : WG1684889,ICAL19300,VPH-50  
ALS Vial : 23 Sample Multiplier: 1

Integration File: autoint1.e  
Quant Time: Sep 16 13:35:50 2022  
Quant Method : C:\Projects\Aquiver Hawaii\2. Laboratory Data\Alpha\Carbon Range Study\L2240634\VPH\NF Data\NF A  
... .09152022.m  
Quant Title : VPH ALIPHATIC  
QLast Update : Fri Sep 16 09:02:50 2022  
Response via : Initial Calibration  
Integrator: ChemStation

Volume Inj. :  
Signal Phase :  
Signal Info :

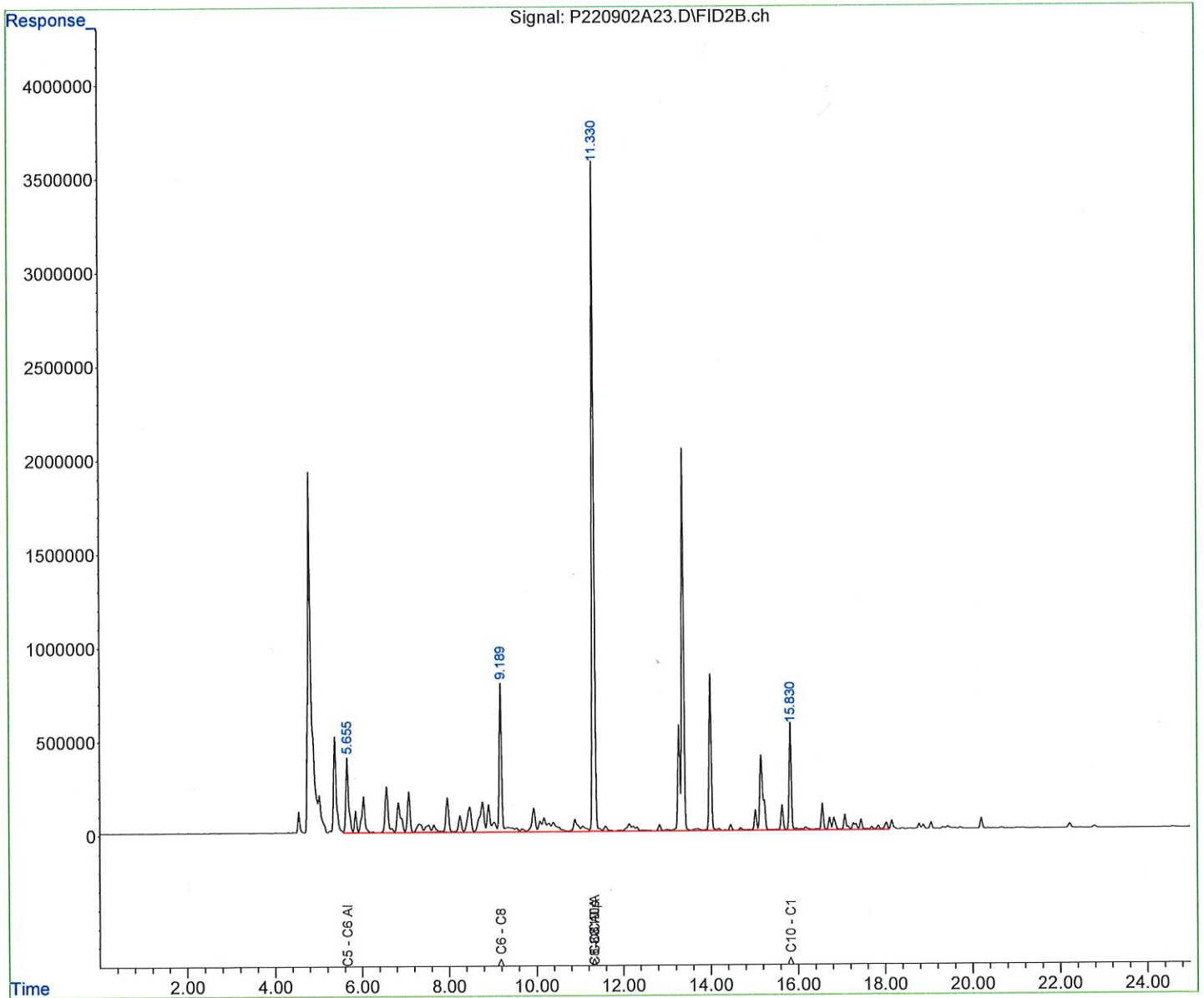



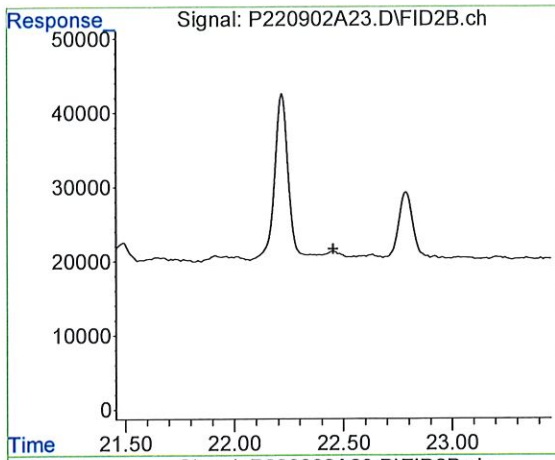

#8 2,5-Dibromotoluene-FID

R.T.: 0.000 min  
 Exp R.T. : 22.454 min  
 Response: 0  
 Conc: N.D.

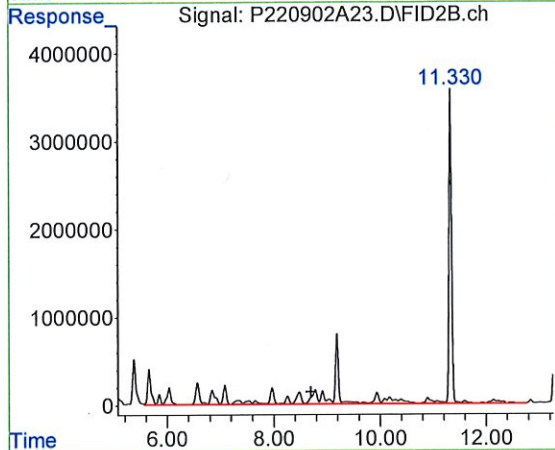

#9 C5-C8 Aliphatics

R.T.: 11.330 min  
 Delta R.T.: 2.636 min  
 Response: 300192561  
 Conc: 2666.32 m

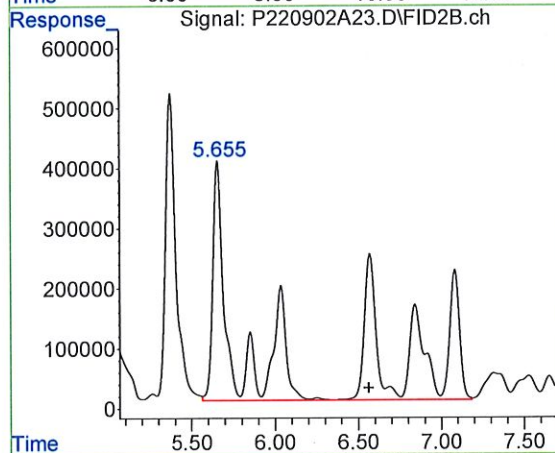

#10 C5 - C6 Aliphatics

R.T.: 5.655 min  
 Delta R.T.: -0.906 min  
 Response: 61735358  
 Conc: 548.34 m

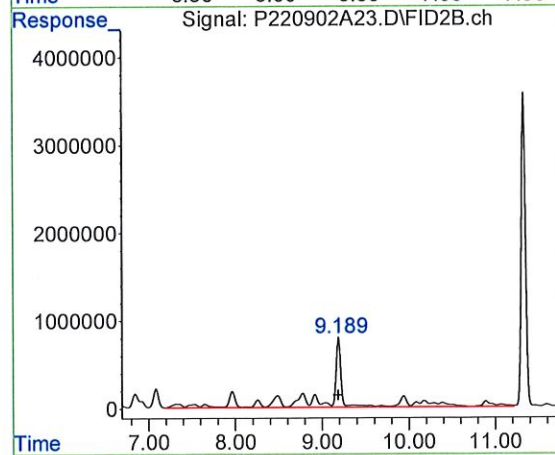

#11 > C6 - C8 Aliphatics

R.T.: 9.189 min  
 Delta R.T.: 0.003 min  
 Response: 107967308  
 Conc: 958.97 m

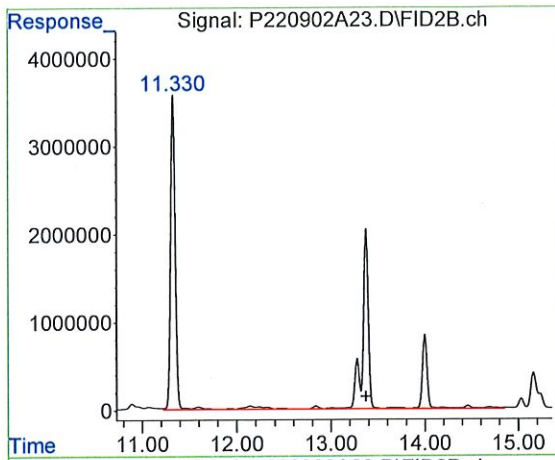

#12 > C8-C10 Aliphatics

R.T.: 11.330 min  
Delta R.T.: -2.041 min  
Response: 251296740  
Conc: 2016.63 m

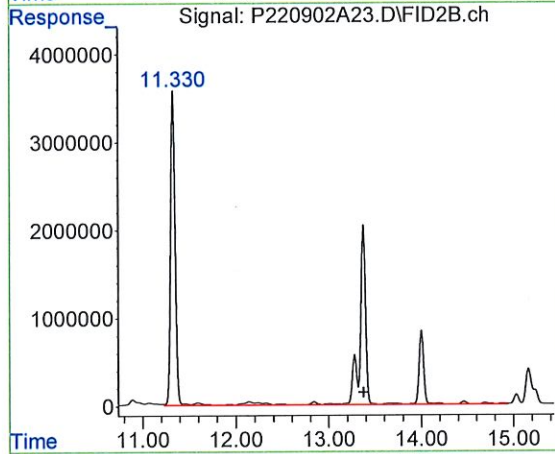

#13 C8 - C10 Aliphatics

R.T.: 11.330 min  
Delta R.T.: -2.044 min  
Response: 250868515  
Conc: 2013.19 m

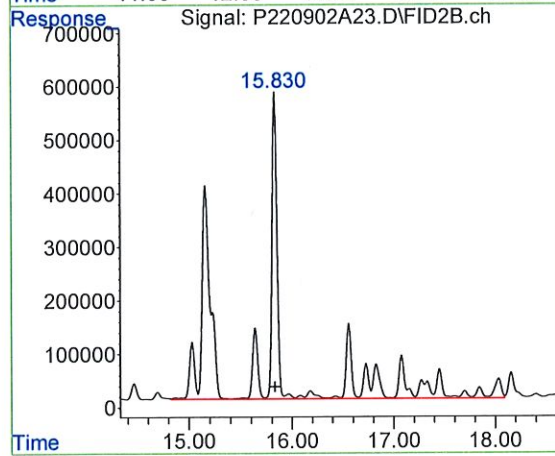

#14 > C10 - C12 Aliphatics

R.T.: 15.830 min  
Delta R.T.: 0.000 min  
Response: 70683996  
Conc: 567.23 m

Quantitation Report (QT Reviewed)

Data Path : C:\Projects\Hawaii DOH\2. Laboratory Data\Alpha\Carbon Range Study\L2240634\VPH\NF Data\Aliphatic Data  
 Data File : P220902A25.D  
 Signal(s) : FID2B.ch  
 Acq On : 2 Sep 2022 9:23 pm  
 Operator : PVPH:BAD  
 Sample : I2240634-04d,41,10,1.14,0.0002,,w  
 Misc : WG1684889,ICAL19300,VPH-50  
 ALS Vial : 25 Sample Multiplier: 1

Integration File: autoint1.e  
 Quant Time: Sep 16 11:02:10 2022  
 Quant Method : C:\Projects\Aquiver Hawaii\2. Laboratory Data\Alpha\Carbon Range Study\L2240634\VPH\NF Data\NF Ali  
 ... .09152022.m  
 Quant Title : VPH ALIPHATIC  
 QLast Update : Fri Sep 16 09:02:50 2022  
 Response via : Initial Calibration  
 Integrator: ChemStation

Volume Inj. :  
 Signal Phase :  
 Signal Info :

Compound	R.T.	Response	Conc	Units
----------	------	----------	------	-------

System Monitoring Compounds

Target Compounds

9) A1 C5-C8 Aliphatics	11.330f	310179084	2755.023	m
10) A2 C5 - C6 Aliphatics	5.655f	63527232	564.251	m
11) A2 > C6 - C8 Aliphatics	9.189	109378360	971.503	m
12) A1 > C8-C10 Aliphatics	11.330f	255951261	2053.977	m
13) A2 C8 - C10 Aliphatics	11.330f	253222488	2032.079	m
14) A2 > C10 - C12 Aliphatics	15.830	67246649	539.646	m

(f)=RT Delta > 1/2 Window

(m)=manual int.

Quantitation Report (QT Reviewed)

Data Path : C:\Projects\Hawaii DOH\2. Laboratory Data\Alpha\Carbon Range Study\L2240634\VPH\NF Data\Aliphatic Da  
Data File : P220902A25.D  
Signal(s) : FID2B.ch  
Acq On : 2 Sep 2022 9:23 pm  
Operator : PVPH:BAD  
Sample : I2240634-04d,41,10,1.14,0.0002,,w  
Misc : WG1684889,ICAL19300,VPH-50  
ALS Vial : 25 Sample Multiplier: 1

Integration File: autoint1.e  
Quant Time: Sep 16 11:02:10 2022  
Quant Method : C:\Projects\Aquiver Hawaii\2. Laboratory Data\Alpha\Carbon Range Study\L2240634\VPH\NF Data\NF A  
... .09152022.m  
Quant Title : VPH ALIPHATIC  
QLast Update : Fri Sep 16 09:02:50 2022  
Response via : Initial Calibration  
Integrator: ChemStation

Volume Inj. :  
Signal Phase :  
Signal Info :

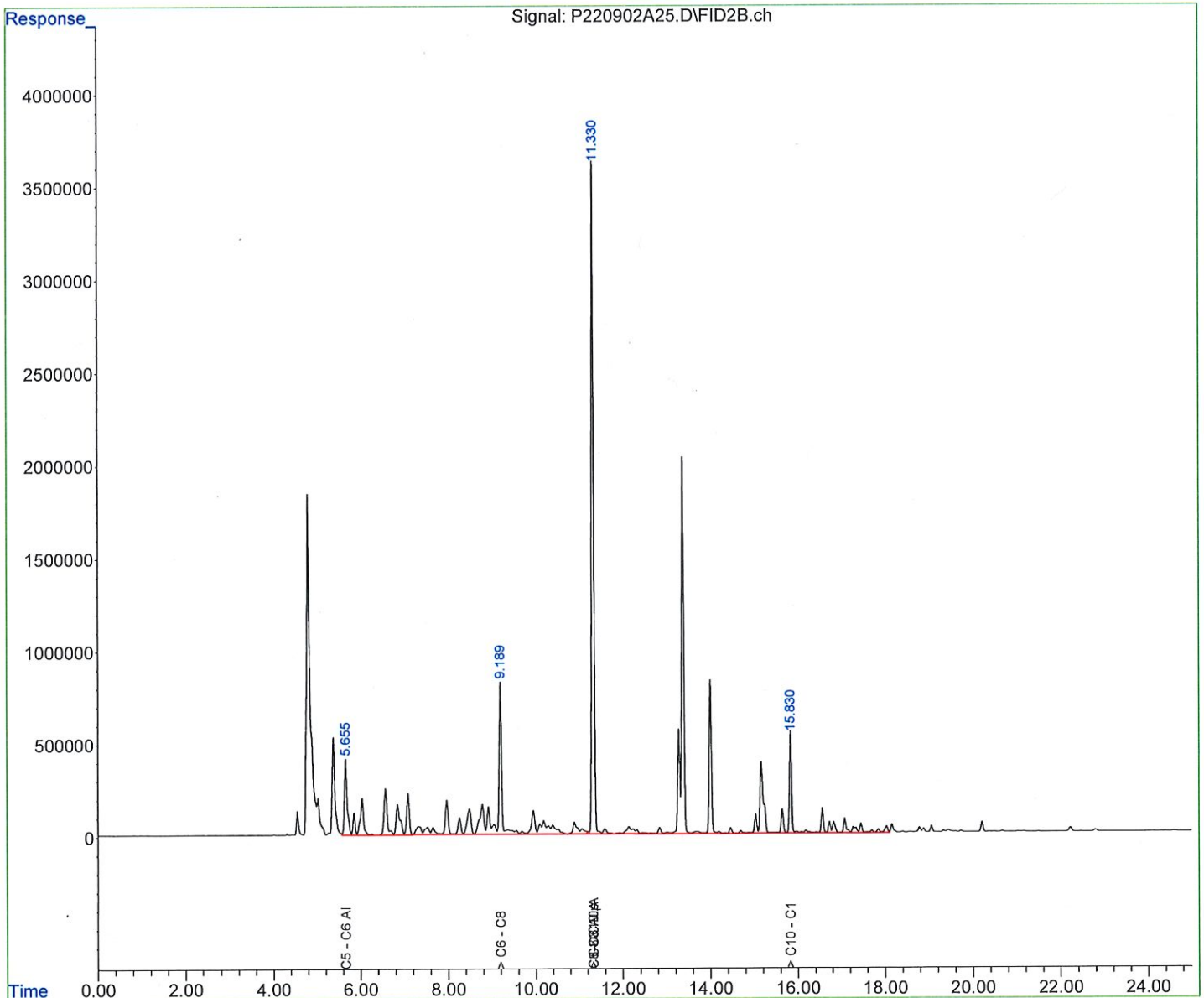

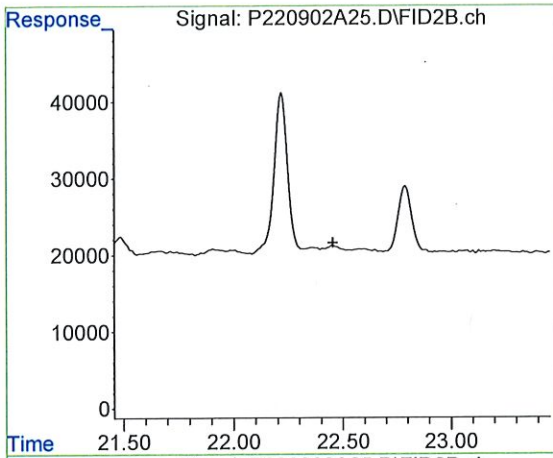

#8 2,5-Dibromotoluene-FID

R.T.: 0.000 min  
 Exp R.T. : 22.454 min  
 Response: 0  
 Conc: N.D.

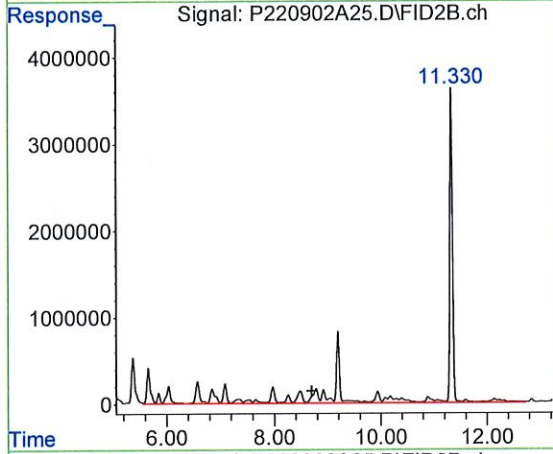

#9 C5-C8 Aliphatics

R.T.: 11.330 min  
 Delta R.T.: 2.636 min  
 Response: 310179084  
 Conc: 2755.02 m

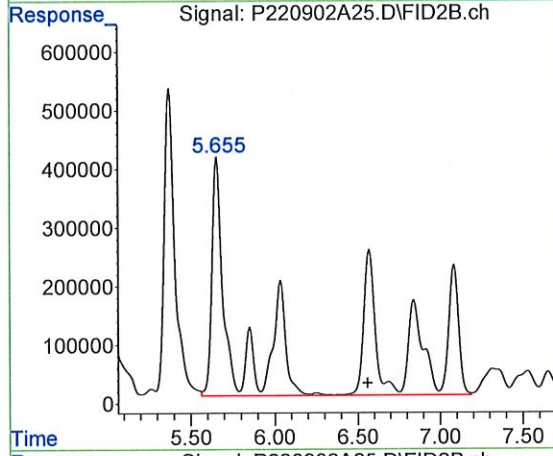

#10 C5 - C6 Aliphatics

R.T.: 5.655 min  
 Delta R.T.: -0.906 min  
 Response: 63527232  
 Conc: 564.25 m

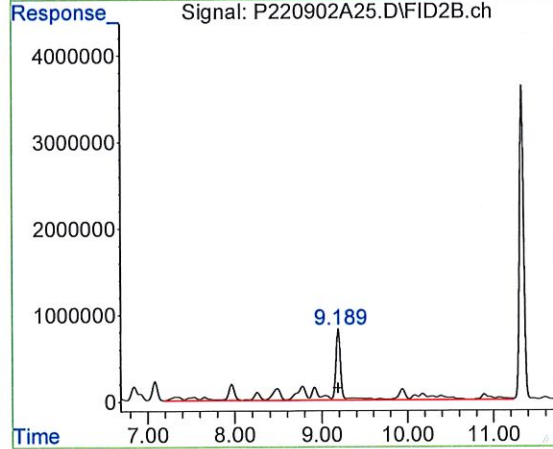

#11 > C6 - C8 Aliphatics

R.T.: 9.189 min  
 Delta R.T.: 0.003 min  
 Response: 109378360  
 Conc: 971.50 m

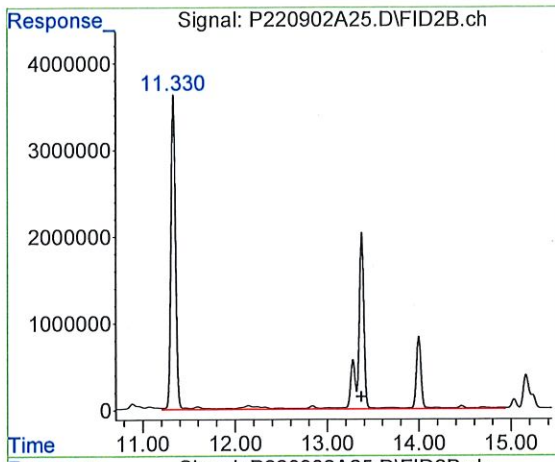

#12 > C8-C10 Aliphatics

R.T.: 11.330 min  
 Delta R.T.: -2.041 min  
 Response: 255951261  
 Conc: 2053.98 m

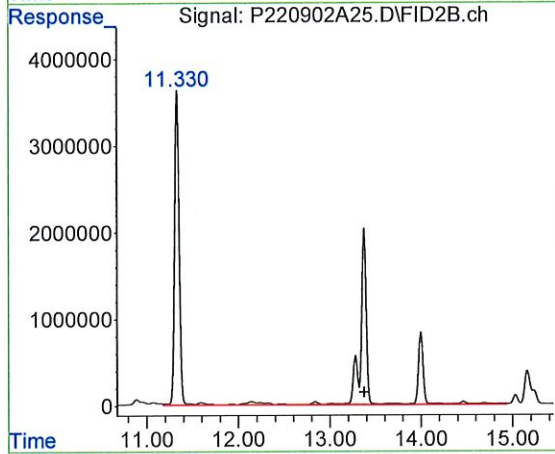

#13 C8 - C10 Aliphatics

R.T.: 11.330 min  
 Delta R.T.: -2.044 min  
 Response: 253222488  
 Conc: 2032.08 m

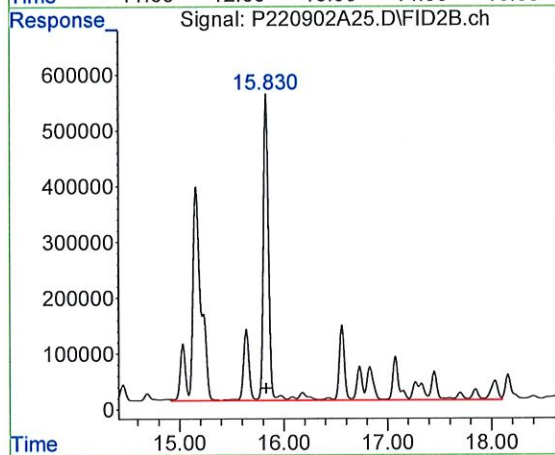

#14 > C10 - C12 Aliphatics

R.T.: 15.830 min  
 Delta R.T.: 0.000 min  
 Response: 67246649  
 Conc: 539.65 m

Quantitation Report (QT Reviewed)

Data Path : C:\Projects\Hawaii DOH\2. Laboratory Data\Alpha\Carbon Range Study\L2240634\VPH\NF Data\Aliphatic Data  
 Data File : P220902A27.D  
 Signal(s) : FID2B.ch  
 Acq On : 2 Sep 2022 10:23 pm  
 Operator : PVPH:BAD  
 Sample : I2240634-07d,41,10,1.17,0.0002,,w  
 Misc : WG1684889,ICAL19300,VPH-50  
 ALS Vial : 27 Sample Multiplier: 1

Integration File: autoint1.e  
 Quant Time: Oct 26 17:03:23 2022  
 Quant Method : C:\Projects\Aquiver Hawaii\2. Laboratory Data\Alpha\Carbon Range Study\L2240634\VPH\NF Data\NF Ali  
 ... .09152022.m  
 Quant Title : VPH ALIPHATIC  
 QLast Update : Fri Sep 16 09:02:50 2022  
 Response via : Initial Calibration  
 Integrator: ChemStation

Volume Inj. :  
 Signal Phase :  
 Signal Info :

Compound	R.T.	Response	Conc Units
----------	------	----------	------------

System Monitoring Compounds

Target Compounds

9) A1 C5-C8 Aliphatics	11.330f	235266727	2089.649 m
10) A2 C5 - C6 Aliphatics	5.655f	45220918	401.654 m
11) A2 > C6 - C8 Aliphatics	9.189	78082300	693.530 m
12) A1 > C8-C10 Aliphatics	11.330f	212562718	1705.790 m
13) A2 C8 - C10 Aliphatics	11.330f	212907744	1708.559 m
14) A2 > C10 - C12 Aliphatics	15.830	54931074	440.815 m

(f)=RT Delta > 1/2 Window

(m)=manual int.

Quantitation Report (QT Reviewed)

Data Path : C:\Projects\Hawaii DOH\2. Laboratory Data\Alpha\Carbon Range Study\L2240634\VPH\NF Data\Aliphatic Da  
Data File : P220902A27.D  
Signal(s) : FID2B.ch  
Acq On : 2 Sep 2022 10:23 pm  
Operator : PVPH:BAD  
Sample : I2240634-07d,41,10,1.17,0.0002,,w  
Misc : WG1684889,ICAL19300,VPH-50  
ALS Vial : 27 Sample Multiplier: 1

Integration File: autoint1.e  
Quant Time: Oct 26 17:03:23 2022  
Quant Method : C:\Projects\Aquiver Hawaii\2. Laboratory Data\Alpha\Carbon Range Study\L2240634\VPH\NF Data\NF A  
... .09152022.m  
Quant Title : VPH ALIPHATIC  
QLast Update : Fri Sep 16 09:02:50 2022  
Response via : Initial Calibration  
Integrator: ChemStation

Volume Inj. :  
Signal Phase :  
Signal Info :

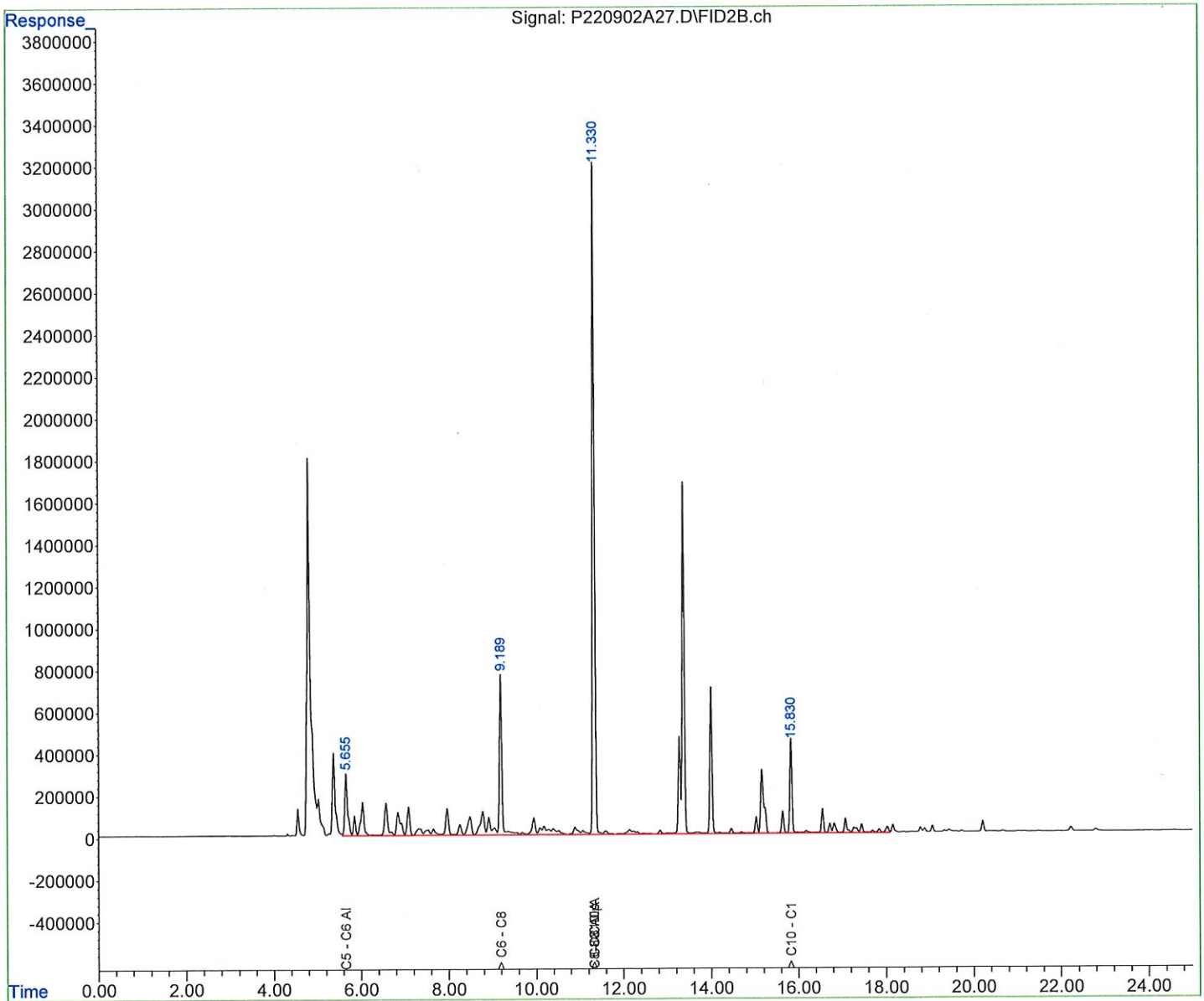



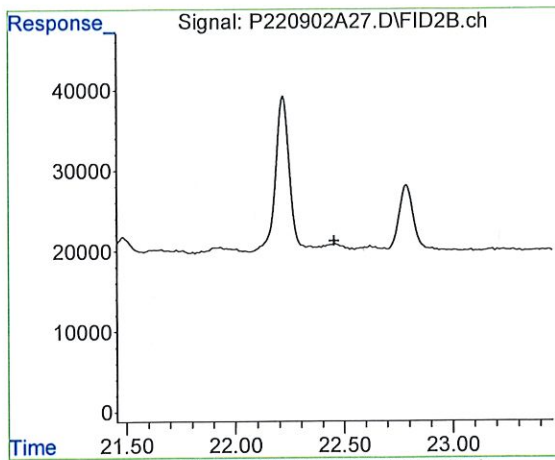

#8 2,5-Dibromotoluene-FID  
 R.T.: 0.000 min  
 Exp R.T. : 22.454 min  
 Response: 0  
 Conc: N.D.

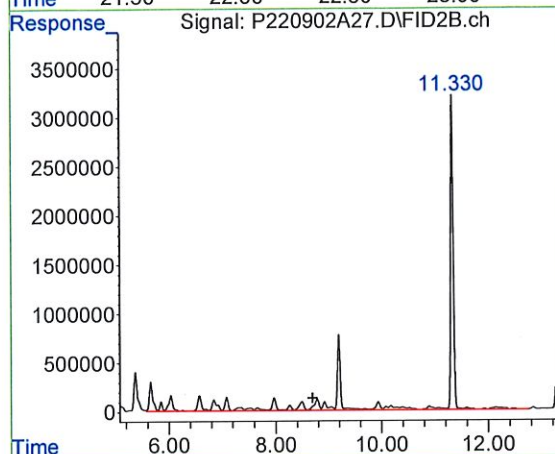

#9 C5-C8 Aliphatics  
 R.T.: 11.330 min  
 Delta R.T.: 2.636 min  
 Response: 235266727  
 Conc: 2089.65 m

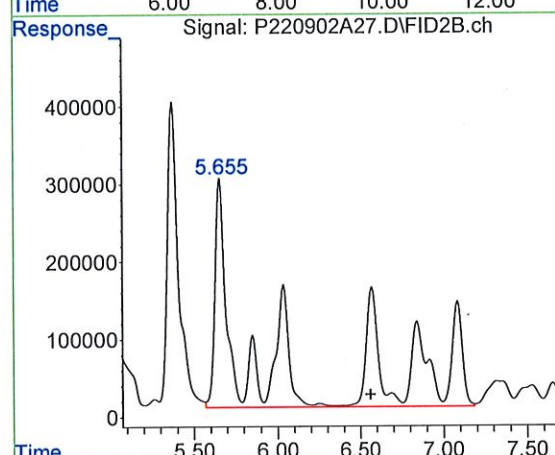

#10 C5 - C6 Aliphatics  
 R.T.: 5.655 min  
 Delta R.T.: -0.906 min  
 Response: 45220918  
 Conc: 401.65 m

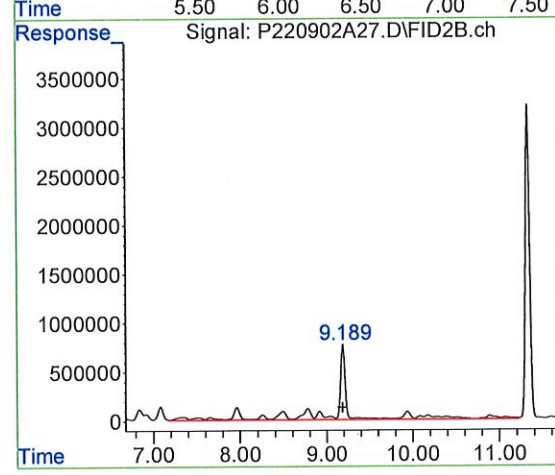

#11 > C6 - C8 Aliphatics  
 R.T.: 9.189 min  
 Delta R.T.: 0.003 min  
 Response: 78082300  
 Conc: 693.53 m

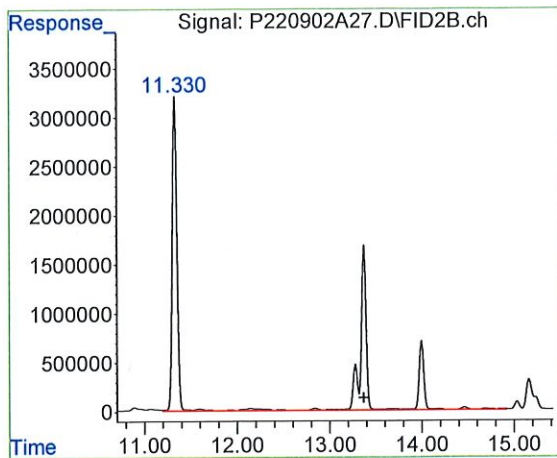

#12 > C8-C10 Aliphatics

R.T.: 11.330 min  
 Delta R.T.: -2.041 min  
 Response: 212562718  
 Conc: 1705.79 m

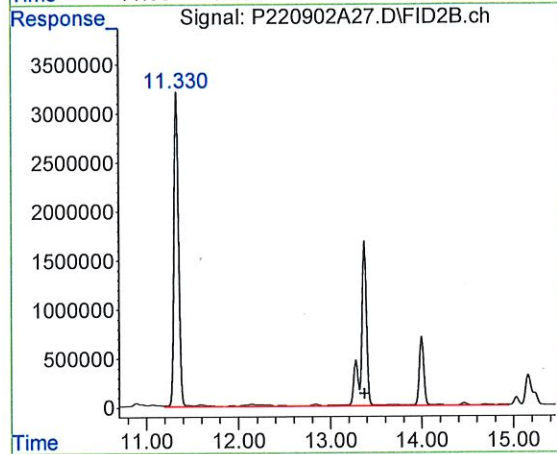

#13 C8 - C10 Aliphatics

R.T.: 11.330 min  
 Delta R.T.: -2.044 min  
 Response: 212907744  
 Conc: 1708.56 m

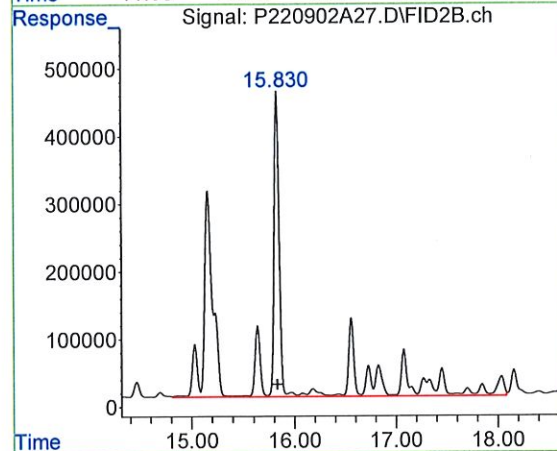

#14 > C10 - C12 Aliphatics

R.T.: 15.830 min  
 Delta R.T.: 0.000 min  
 Response: 54931074  
 Conc: 440.82 m

Quantitation Report (QT Reviewed)

Data Path : C:\Projects\Hawaii DOH\2. Laboratory Data\Alpha\Carbon Range Study\L2240634\VPH\NF Data\Aliphatic Data  
 Data File : P220902A29.D  
 Signal(s) : FID2B.ch  
 Acq On : 2 Sep 2022 11:23 pm  
 Operator : PVPH:BAD  
 Sample : I2240634-10d,41,10,1.17,0.0005,,z  
 Misc : WG1684889,ICAL19300,VPH-50  
 ALS Vial : 29 Sample Multiplier: 1

Integration File: autoint1.e  
 Quant Time: Oct 21 11:44:02 2022  
 Quant Method : C:\Projects\Aquiver Hawaii\2. Laboratory Data\Alpha\Carbon Range Study\L2240634\VPH\NF Data\NF Ali  
 ... .09152022.m  
 Quant Title : VPH ALIPHATIC  
 QLast Update : Fri Sep 16 09:02:50 2022  
 Response via : Initial Calibration  
 Integrator: ChemStation

Volume Inj. :  
 Signal Phase :  
 Signal Info :

Compound	R.T.	Response	Conc	Units
----------	------	----------	------	-------

System Monitoring Compounds

Target Compounds

9) A1 C5-C8 Aliphatics	12.138f	38324948	340.404	m
10) A2 C5 - C6 Aliphatics	5.656f	2454292	21.799	m
11) A2 > C6 - C8 Aliphatics	10.887f	10108723	89.786	m
12) A1 > C8-C10 Aliphatics	14.689f	176571573	1416.965	m
13) A2 C8 - C10 Aliphatics	14.689f	164212163	1317.782	m
14) A2 > C10 - C12 Aliphatics	15.830	338492923	2716.364	m

(f)=RT Delta > 1/2 Window

(m)=manual int.

Quantitation Report (QT Reviewed)

Data Path : C:\Projects\Hawaii DOH\2. Laboratory Data\Alpha\Carbon Range Study\L2240634\VPH\NF Data\Aliphatic Da  
Data File : P220902A29.D  
Signal(s) : FID2B.ch  
Acq On : 2 Sep 2022 11:23 pm  
Operator : PVPH:BAD  
Sample : I2240634-10d,41,10,1.17,0.0005,,z  
Misc : WG1684889,ICAL19300,VPH-50  
ALS Vial : 29 Sample Multiplier: 1

Integration File: autoint1.e  
Quant Time: Oct 21 11:44:02 2022  
Quant Method : C:\Projects\Aquiver Hawaii\2. Laboratory Data\Alpha\Carbon Range Study\L2240634\VPH\NF Data\NF A  
... .09152022.m  
Quant Title : VPH ALIPHATIC  
QLast Update : Fri Sep 16 09:02:50 2022  
Response via : Initial Calibration  
Integrator: ChemStation

Volume Inj. :  
Signal Phase :  
Signal Info :

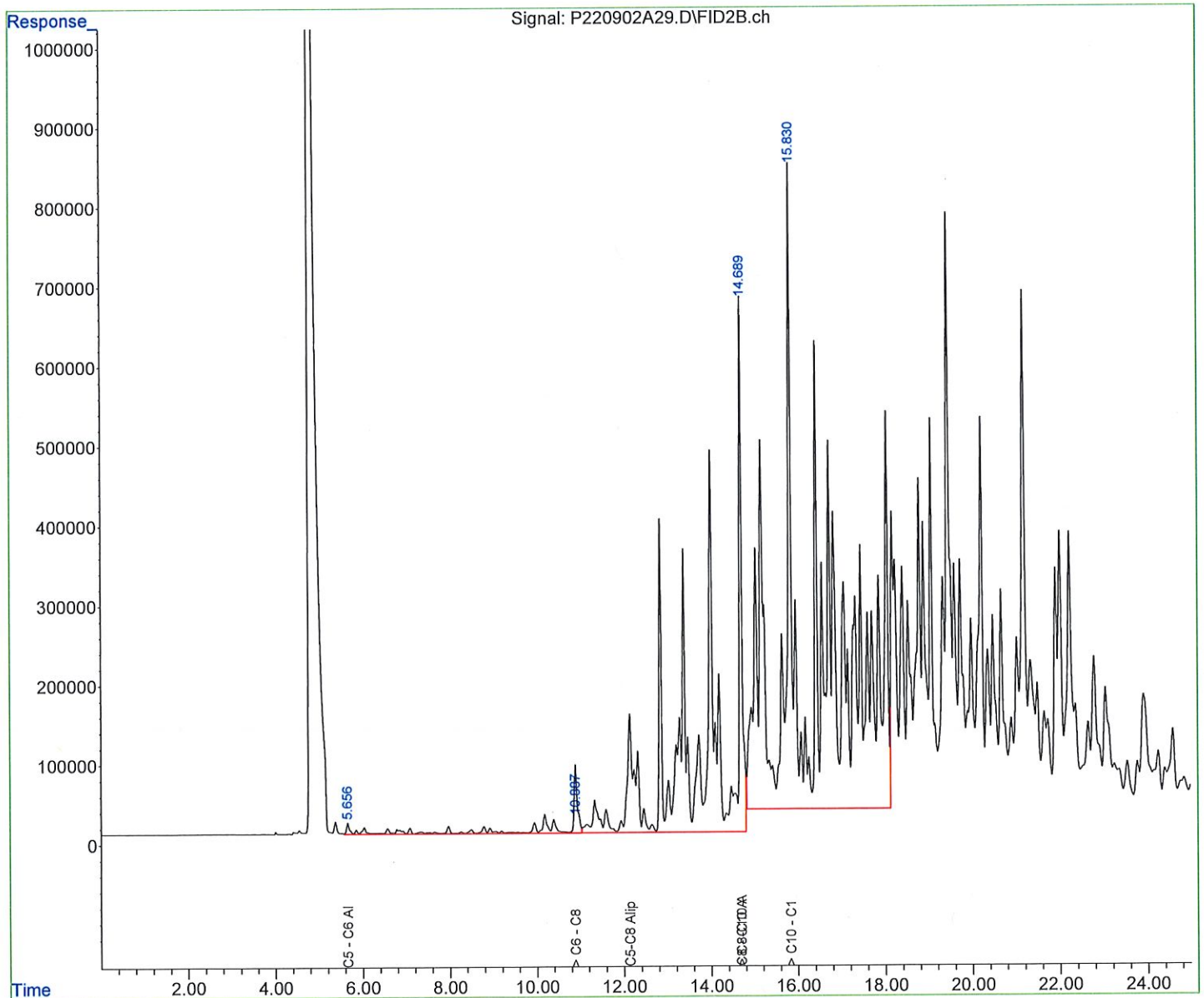

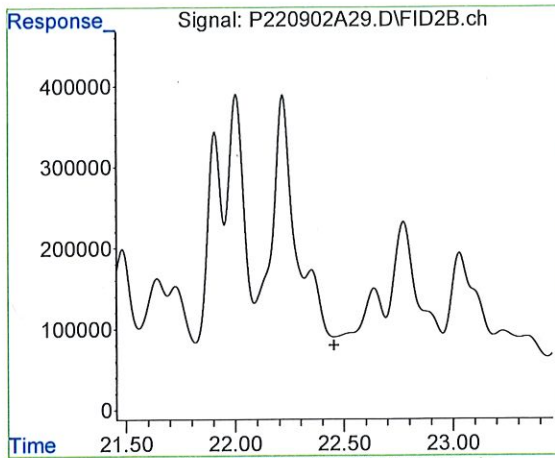

#8 2,5-Dibromotoluene-FID

R.T.: 0.000 min  
 Exp R.T. : 22.454 min  
 Response: 0  
 Conc: N.D.

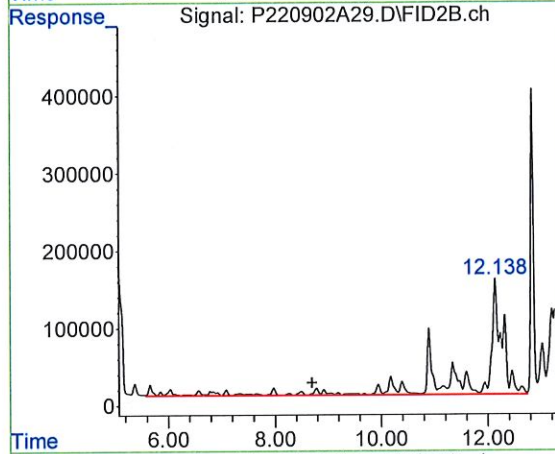

#9 C5-C8 Aliphatics

R.T.: 12.138 min  
 Delta R.T.: 3.444 min  
 Response: 38324948  
 Conc: 340.40 m

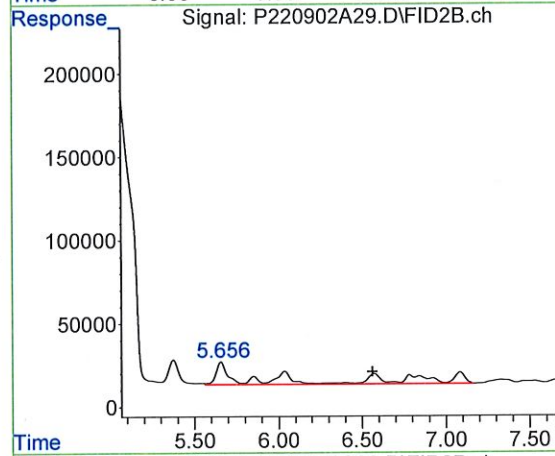

#10 C5 - C6 Aliphatics

R.T.: 5.656 min  
 Delta R.T.: -0.905 min  
 Response: 2454292  
 Conc: 21.80 m

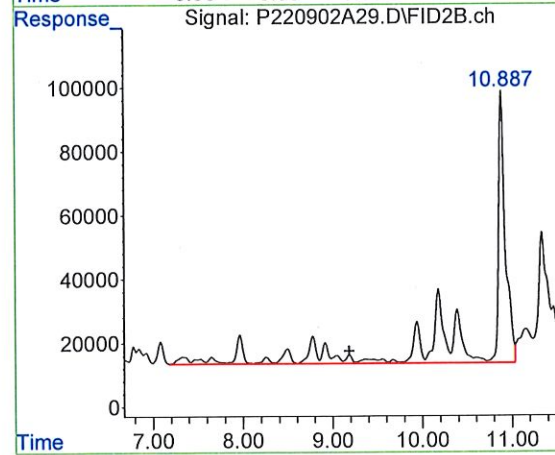

#11 > C6 - C8 Aliphatics

R.T.: 10.887 min  
 Delta R.T.: 1.701 min  
 Response: 10108723  
 Conc: 89.79 m

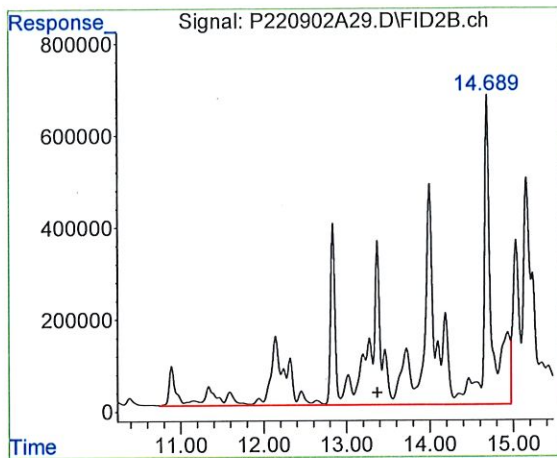

#12 > C8-C10 Aliphatics

R.T.: 14.689 min  
Delta R.T.: 1.318 min  
Response: 176571573  
Conc: 1416.97 m

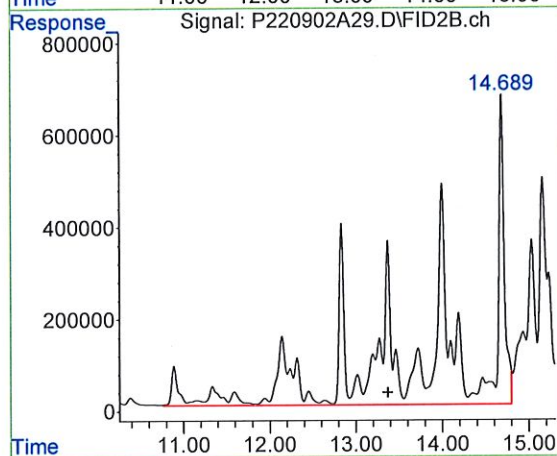

#13 C8 - C10 Aliphatics

R.T.: 14.689 min  
Delta R.T.: 1.315 min  
Response: 164212163  
Conc: 1317.78 m

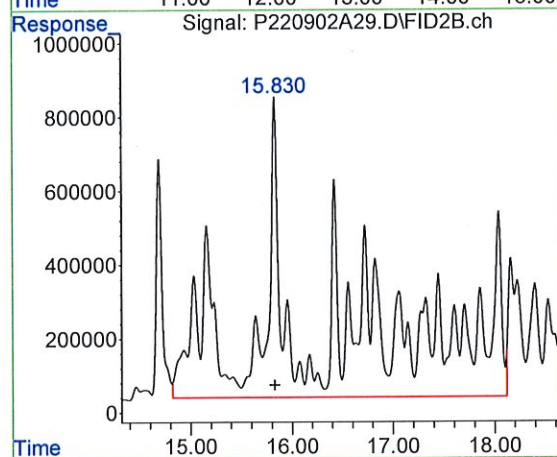

#14 > C10 - C12 Aliphatics

R.T.: 15.830 min  
Delta R.T.: 0.000 min  
Response: 338492923  
Conc: 2716.36 m

Quantitation Report (QT Reviewed)

Data Path : C:\Projects\Hawaii DOH\2. Laboratory Data\Alpha\Carbon Range Study\L2240634\VPH\NF Data\Aliphatic Data  
 Data File : P220902A31.D  
 Signal(s) : FID2B.ch  
 Acq On : 3 Sep 2022 12:23 am  
 Operator : PVPH:BAD  
 Sample : I2240634-13d,41,10,1.67,0.0005,,w  
 Misc : WG1684889,ICAL19300,VPH-50  
 ALS Vial : 31 Sample Multiplier: 1

Integration File: autoint1.e  
 Quant Time: Sep 16 14:57:20 2022  
 Quant Method : C:\Projects\Aquiver Hawaii\2. Laboratory Data\Alpha\Carbon Range Study\L2240634\VPH\NF Data\NF Ali  
 ... .09152022.m  
 Quant Title : VPH ALIPHATIC  
 QLast Update : Fri Sep 16 09:02:50 2022  
 Response via : Initial Calibration  
 Integrator: ChemStation

Volume Inj. :  
 Signal Phase :  
 Signal Info :

Compound	R.T.	Response	Conc Units
----------	------	----------	------------

System Monitoring Compounds

Target Compounds

9) A1 C5-C8 Aliphatics	11.330f	41789542	371.176 m
10) A2 C5 - C6 Aliphatics	5.654f	1574382	13.984 m
11) A2 > C6 - C8 Aliphatics	9.937	13911422	123.562 m
12) A1 > C8-C10 Aliphatics	13.373	179764104	1442.585 m
13) A2 C8 - C10 Aliphatics	13.373	181295100	1454.871 m
14) A2 > C10 - C12 Aliphatics	15.830	354633889	2845.893 m

(f)=RT Delta > 1/2 Window

(m)=manual int.

Quantitation Report (QT Reviewed)

Data Path : C:\Projects\Hawaii DOH\2. Laboratory Data\Alpha\Carbon Range Study\L2240634\VPH\NF Data\Aliphatic Da  
Data File : P220902A31.D  
Signal(s) : FID2B.ch  
Acq On : 3 Sep 2022 12:23 am  
Operator : PVPH:BAD  
Sample : I2240634-13d,41,10,1.67,0.0005,,w  
Misc : WG1684889,ICAL19300,VPH-50  
ALS Vial : 31 Sample Multiplier: 1

Integration File: autoint1.e  
Quant Time: Sep 16 14:57:20 2022  
Quant Method : C:\Projects\Aquiver Hawaii\2. Laboratory Data\Alpha\Carbon Range Study\L2240634\VPH\NF Data\NF A  
... .09152022.m  
Quant Title : VPH ALIPHATIC  
QLast Update : Fri Sep 16 09:02:50 2022  
Response via : Initial Calibration  
Integrator: ChemStation

Volume Inj. :  
Signal Phase :  
Signal Info :

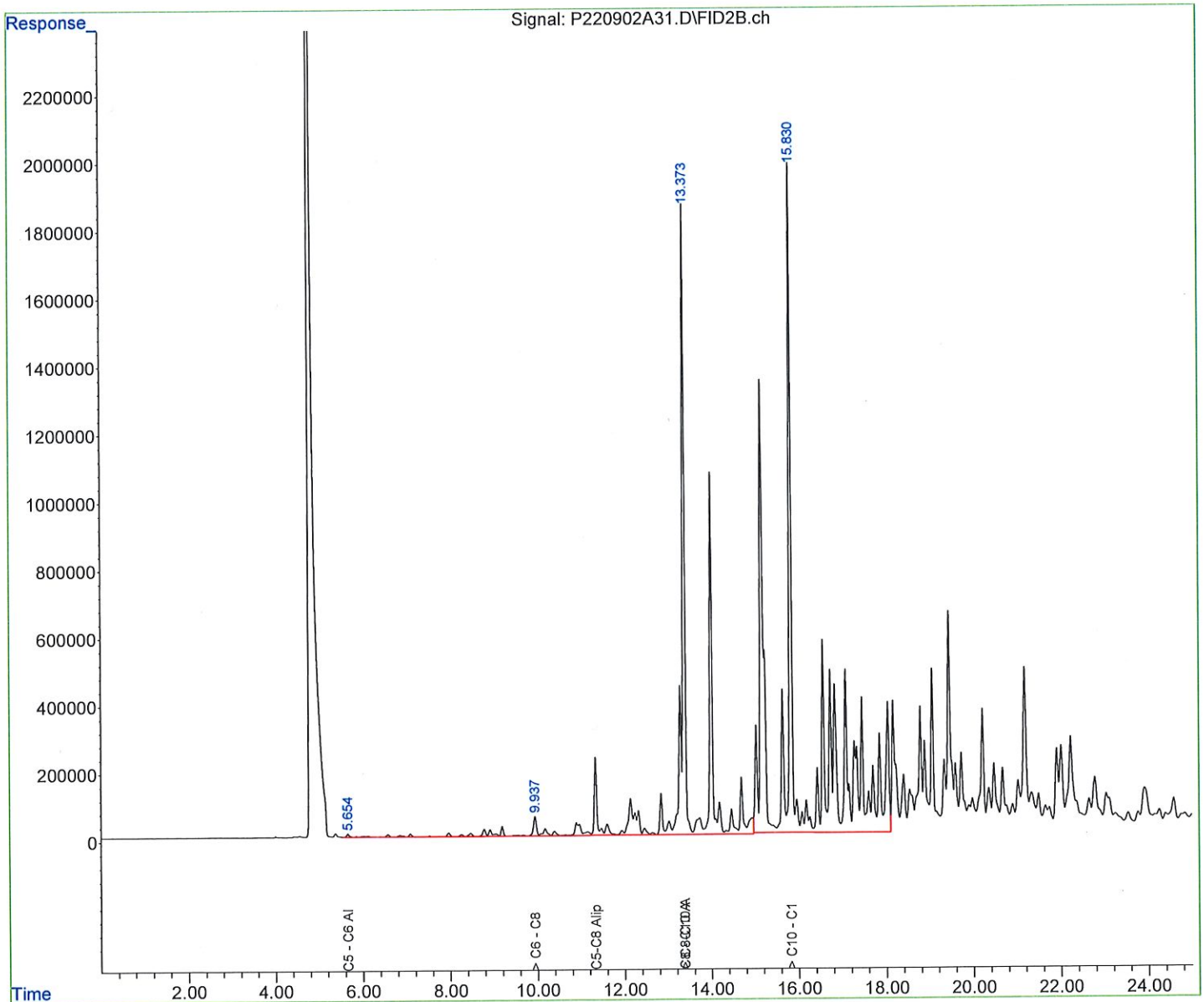



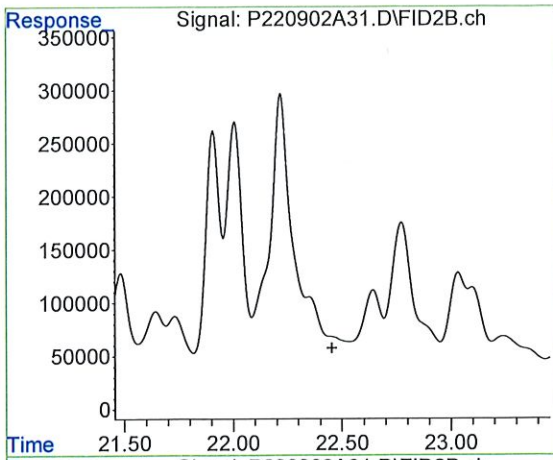

#8 2,5-Dibromotoluene-FID

R.T.: 0.000 min  
 Exp R.T. : 22.454 min  
 Response: 0  
 Conc: N.D.

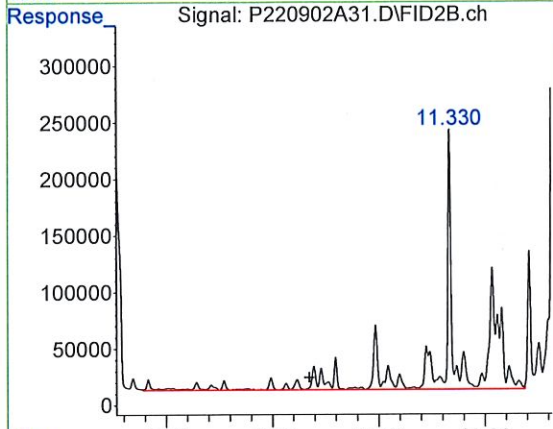

#9 C5-C8 Aliphatics

R.T.: 11.330 min  
 Delta R.T.: 2.636 min  
 Response: 41789542  
 Conc: 371.18 m

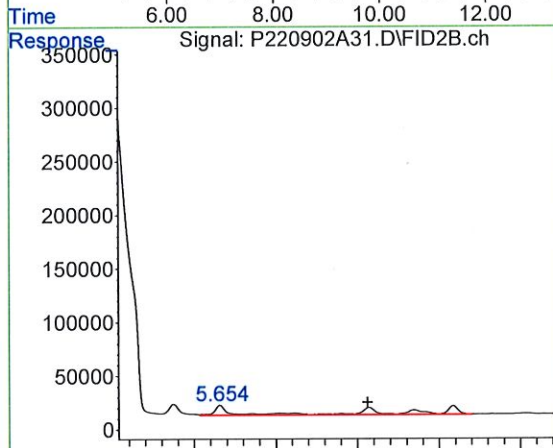

#10 C5 - C6 Aliphatics

R.T.: 5.654 min  
 Delta R.T.: -0.907 min  
 Response: 1574382  
 Conc: 13.98 m

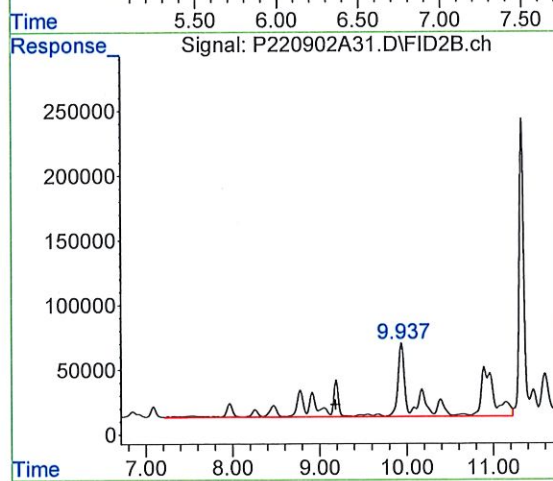

#11 > C6 - C8 Aliphatics

R.T.: 9.937 min  
 Delta R.T.: 0.751 min  
 Response: 13911422  
 Conc: 123.56 m

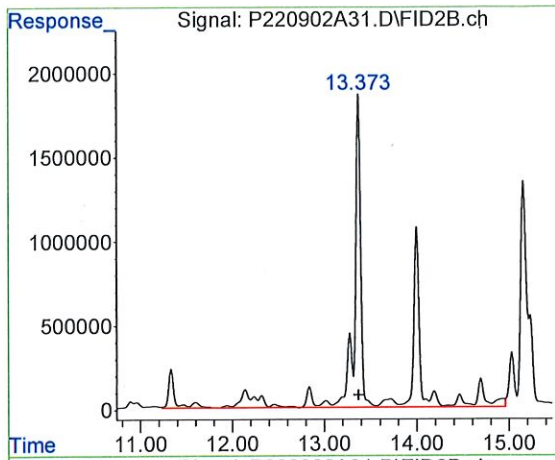

#12 > C8-C10 Aliphatics

R.T.: 13.373 min  
 Delta R.T.: 0.002 min  
 Response: 179764104  
 Conc: 1442.58 m

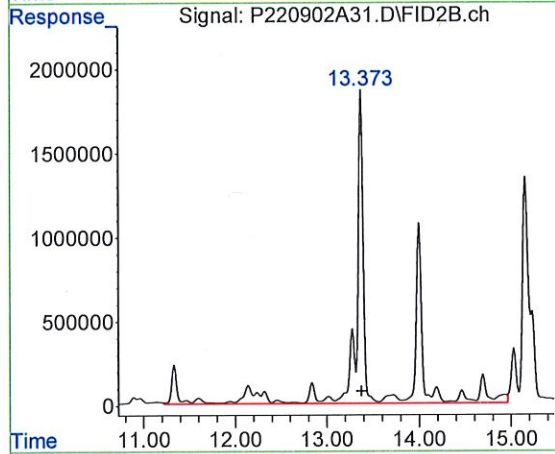

#13 C8 - C10 Aliphatics

R.T.: 13.373 min  
 Delta R.T.: 0.000 min  
 Response: 181295100  
 Conc: 1454.87 m

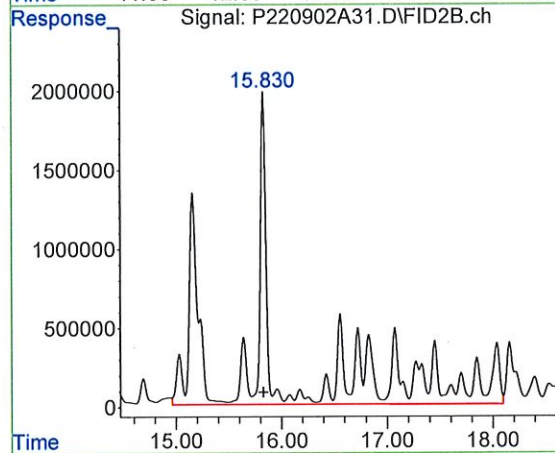

#14 > C10 - C12 Aliphatics

R.T.: 15.830 min  
 Delta R.T.: 0.000 min  
 Response: 354633889  
 Conc: 2845.89 m

Quantitation Report (QT Reviewed)

Data Path : C:\Projects\Hawaii DOH\2. Laboratory Data\Alpha\Carbon Range Study\L2240634\VP\NF Data\Aliphatic Data  
 Data File : P220902A33.D  
 Signal(s) : FID2B.ch  
 Acq On : 3 Sep 2022 1:23 am  
 Operator : PVPH:BAD  
 Sample : I2240634-25d,41,10,1.17,0.005,,w  
 Misc : WG1684889,ICAL19300,VP-50  
 ALS Vial : 33 Sample Multiplier: 1

Integration File: autoint1.e  
 Quant Time: Oct 21 11:46:04 2022  
 Quant Method : C:\Projects\Aquiver Hawaii\2. Laboratory Data\Alpha\Carbon Range Study\L2240634\VP\NF Data\NF Ali  
 ... .09152022.m  
 Quant Title : VPH ALIPHATIC  
 QLast Update : Fri Sep 16 09:02:50 2022  
 Response via : Initial Calibration  
 Integrator: ChemStation

Volume Inj. :  
 Signal Phase :  
 Signal Info :

Compound	R.T.	Response	Conc	Units
<b>System Monitoring Compounds</b>				
8) s 2,5-Dibromotoluene-FID	22.355f	18998220	469.977	
Spiked Amount	250.000	Recovery = 187.99%		
<b>Target Compounds</b>				
9) A1 C5-C8 Aliphatics	12.140f	10589513	94.056	m
10) A2 C5 - C6 Aliphatics	6.777	1817701	16.145	m
11) A2 > C6 - C8 Aliphatics	10.888f	3040048	27.002	m
12) A1 > C8-C10 Aliphatics	14.688f	45405379	364.373	m
13) A2 C8 - C10 Aliphatics	14.688f	40299446	323.398	m
14) A2 > C10 - C12 Aliphatics	18.042f	628687699	5045.142	m

(f)=RT Delta > 1/2 Window (m)=manual int.

Quantitation Report (QT Reviewed)

Data Path : C:\Projects\Hawaii DOH\2. Laboratory Data\Alpha\Carbon Range Study\L2240634\VPH\NF Data\Aliphatic Da  
Data File : P220902A33.D  
Signal(s) : FID2B.ch  
Acq On : 3 Sep 2022 1:23 am  
Operator : PVPH:BAD  
Sample : I2240634-25d,41,10,1.17,0.005,,w  
Misc : WG1684889,ICAL19300,VPH-50  
ALS Vial : 33 Sample Multiplier: 1

Integration File: autoint1.e  
Quant Time: Oct 21 11:46:04 2022  
Quant Method : C:\Projects\Aquiver Hawaii\2. Laboratory Data\Alpha\Carbon Range Study\L2240634\VPH\NF Data\NF A  
... .09152022.m  
Quant Title : VPH ALIPHATIC  
QLast Update : Fri Sep 16 09:02:50 2022  
Response via : Initial Calibration  
Integrator: ChemStation

Volume Inj. :  
Signal Phase :  
Signal Info :

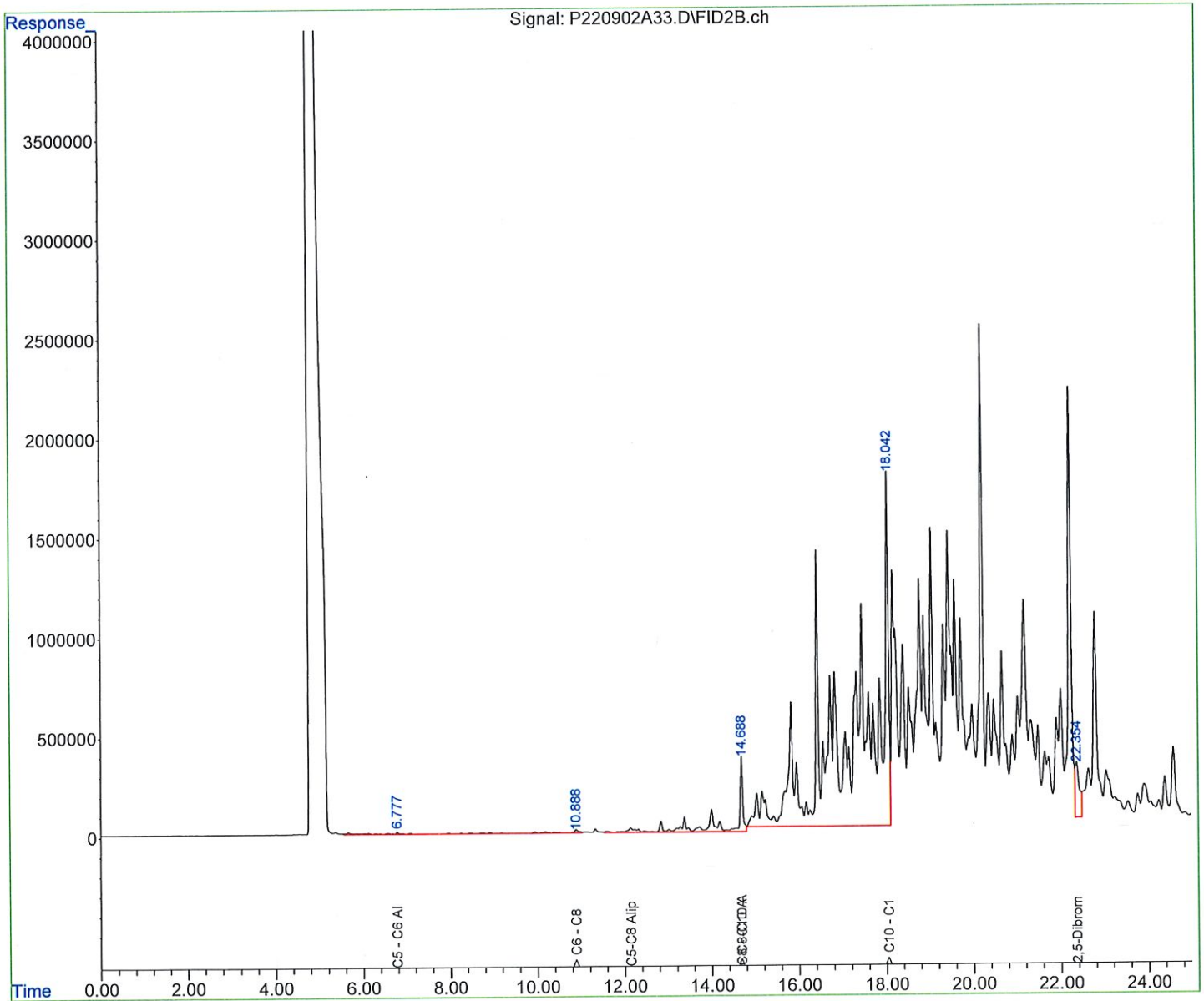

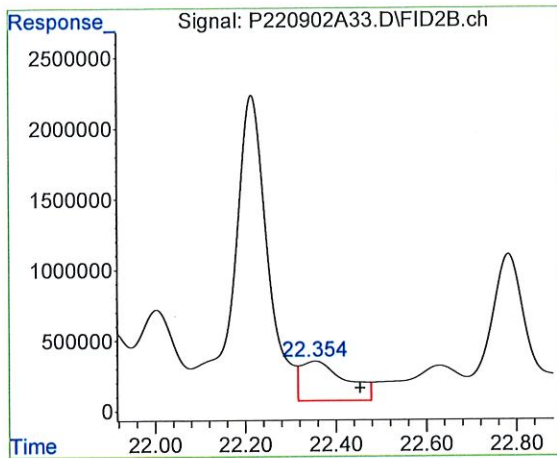

#8 2,5-Dibromotoluene-FID

R.T.: 22.355 min  
 Delta R.T.: -0.099 min  
 Response: 18998220  
 Conc: 469.98

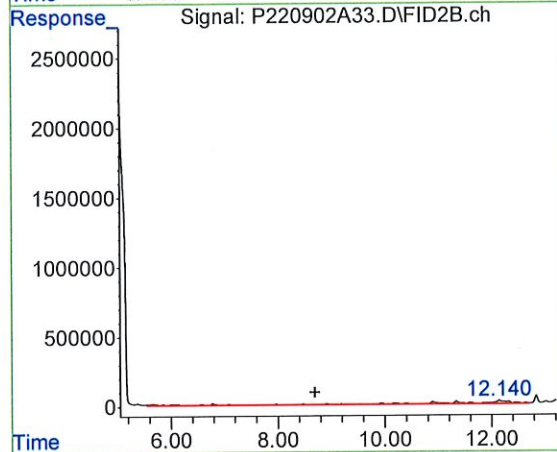

#9 C5-C8 Aliphatics

R.T.: 12.140 min  
 Delta R.T.: 3.446 min  
 Response: 10589513  
 Conc: 94.06 m

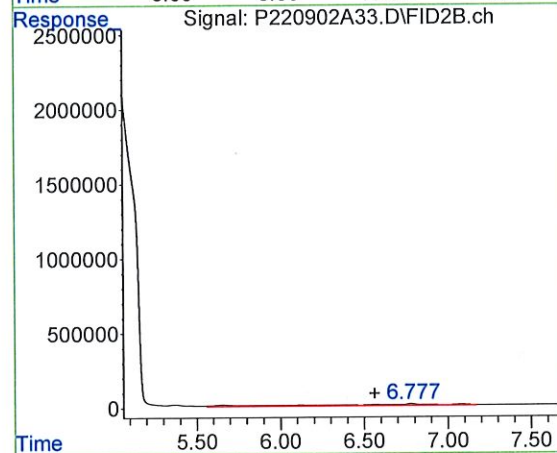

#10 C5 - C6 Aliphatics

R.T.: 6.777 min  
 Delta R.T.: 0.216 min  
 Response: 1817701  
 Conc: 16.14 m

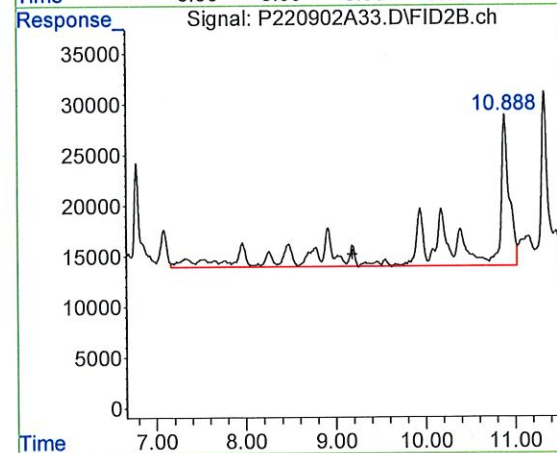

#11 > C6 - C8 Aliphatics

R.T.: 10.888 min  
 Delta R.T.: 1.702 min  
 Response: 3040048  
 Conc: 27.00 m

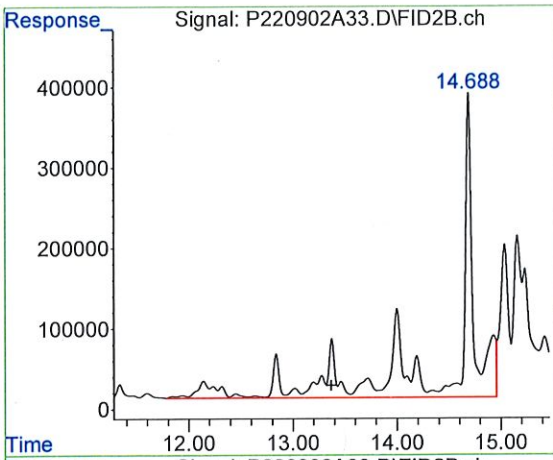

#12 > C8-C10 Aliphatics

R.T.: 14.688 min  
 Delta R.T.: 1.317 min  
 Response: 45405379  
 Conc: 364.37 m

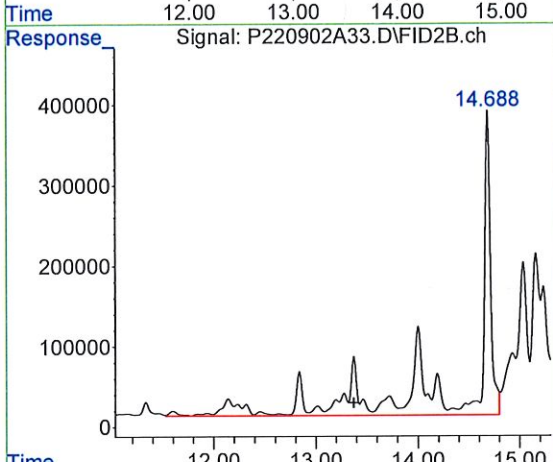

#13 C8 - C10 Aliphatics

R.T.: 14.688 min  
 Delta R.T.: 1.314 min  
 Response: 40299446  
 Conc: 323.40 m

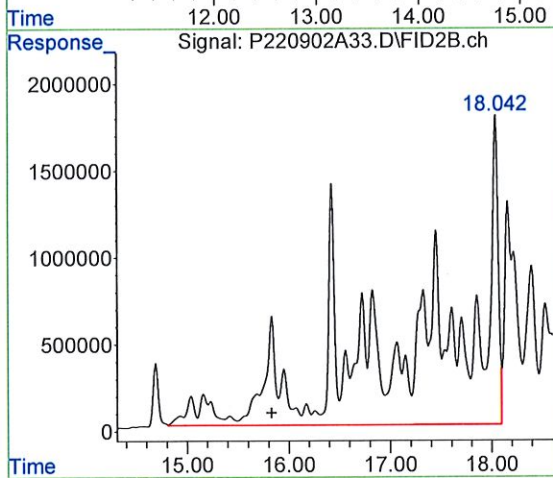

#14 > C10 - C12 Aliphatics

R.T.: 18.042 min  
 Delta R.T.: 2.212 min  
 Response: 628687699  
 Conc: 5045.14 m

Quantitation Report (QT Reviewed)

Data Path : C:\Projects\Hawaii DOH\2. Laboratory Data\Alpha\Carbon Range Study\L2240634\VP\NF Data\Aliphatic Data  
 Data File : P220902A35.D  
 Signal(s) : FID2B.ch  
 Acq On : 3 Sep 2022 2:22 am  
 Operator : PVPH:BAD  
 Sample : I2240634-32d,41,10,1.01,0.02,,z  
 Misc : WG1684889,ICAL19300,VP-50  
 ALS Vial : 35 Sample Multiplier: 1

Integration File: autoint1.e  
 Quant Time: Oct 21 11:48:01 2022  
 Quant Method : C:\Projects\Aquiver Hawaii\2. Laboratory Data\Alpha\Carbon Range Study\L2240634\VP\NF Data\NF Ali  
 ... .09152022.m  
 Quant Title : VPH ALIPHATIC  
 QLast Update : Fri Sep 16 09:02:50 2022  
 Response via : Initial Calibration  
 Integrator: ChemStation

Volume Inj. :  
 Signal Phase :  
 Signal Info :

Compound	R.T.	Response	Conc	Units
----------	------	----------	------	-------

System Monitoring Compounds

Target Compounds

9) A1 C5-C8 Aliphatics	11.329f	286089755	2541.061	m
10) A2 C5 - C6 Aliphatics	6.851	22433507	199.255	m
11) A2 > C6 - C8 Aliphatics	8.907	138597802	1231.031	m
12) A1 > C8-C10 Aliphatics	13.373	352626722	2829.786	m
13) A2 C8 - C10 Aliphatics	13.373	458724925	3681.211	m
14) A2 > C10 - C12 Aliphatics	15.830	702543749	5637.827	m

(f)=RT Delta > 1/2 Window

(m)=manual int.

Quantitation Report (QT Reviewed)

Data Path : C:\Projects\Hawaii DOH\2. Laboratory Data\Alpha\Carbon Range Study\L2240634\VPH\NF Data\Aliphatic Da  
Data File : P220902A35.D  
Signal(s) : FID2B.ch  
Acq On : 3 Sep 2022 2:22 am  
Operator : PVPH:BAD  
Sample : I2240634-32d,41,10,1.01,0.02,,z  
Misc : WG1684889,ICAL19300,VPH-50  
ALS Vial : 35 Sample Multiplier: 1

Integration File: autoint1.e  
Quant Time: Oct 21 11:48:01 2022  
Quant Method : C:\Projects\Aquiver Hawaii\2. Laboratory Data\Alpha\Carbon Range Study\L2240634\VPH\NF Data\NF A  
... .09152022.m  
Quant Title : VPH ALIPHATIC  
QLast Update : Fri Sep 16 09:02:50 2022  
Response via : Initial Calibration  
Integrator: ChemStation

Volume Inj. :  
Signal Phase :  
Signal Info :

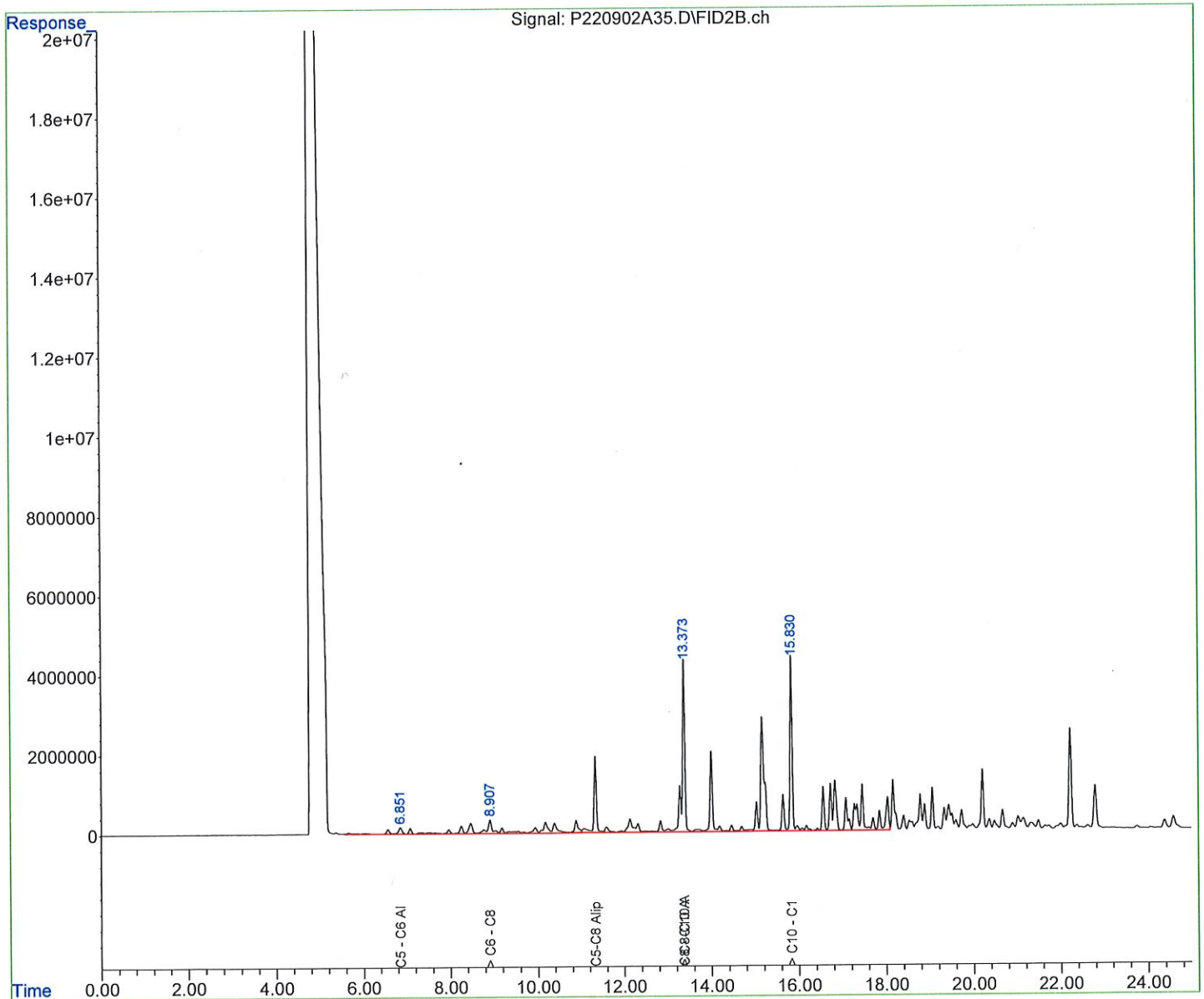



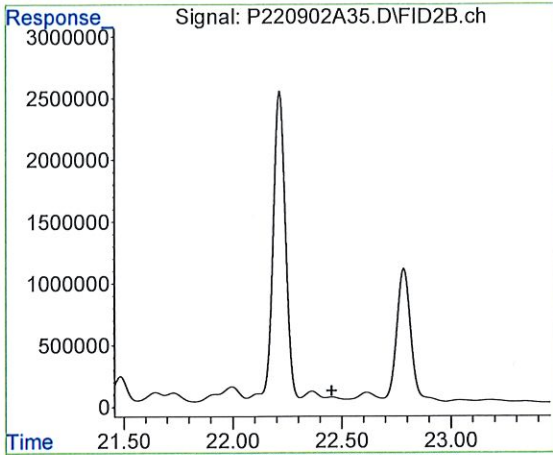

#8 2,5-Dibromotoluene-FID

R.T.: 0.000 min  
 Exp R.T. : 22.454 min  
 Response: 0  
 Conc: N.D.

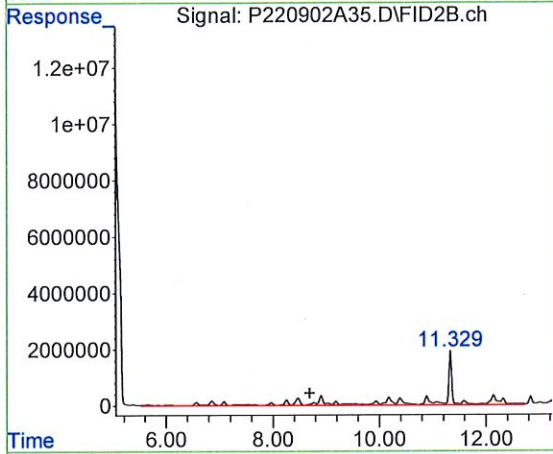

#9 C5-C8 Aliphatics

R.T.: 11.329 min  
 Delta R.T.: 2.635 min  
 Response: 286089755  
 Conc: 2541.06 m

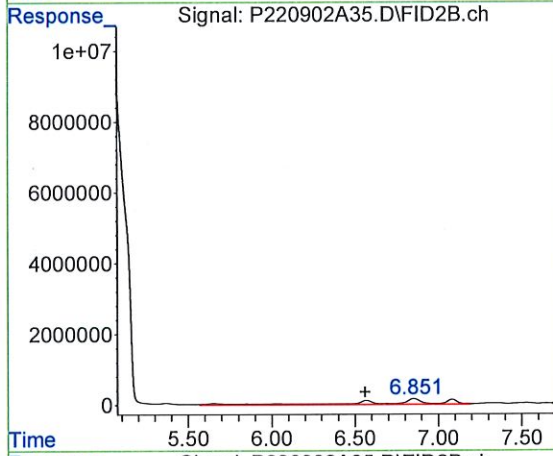

#10 C5 - C6 Aliphatics

R.T.: 6.851 min  
 Delta R.T.: 0.290 min  
 Response: 22433507  
 Conc: 199.26 m

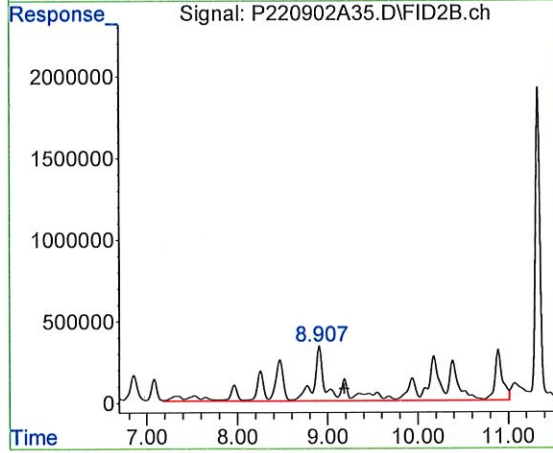

#11 > C6 - C8 Aliphatics

R.T.: 8.907 min  
 Delta R.T.: -0.279 min  
 Response: 138597802  
 Conc: 1231.03 m

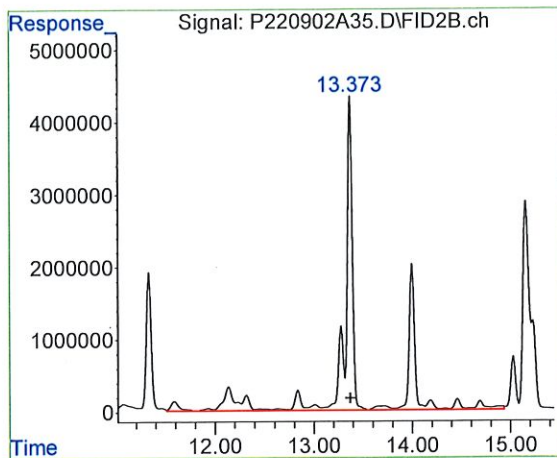

#12 > C8-C10 Aliphatics

R.T.: 13.373 min  
 Delta R.T.: 0.002 min  
 Response: 352626722  
 Conc: 2829.79 m

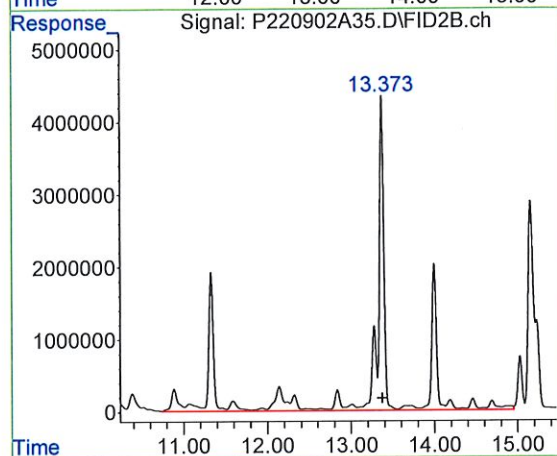

#13 C8 - C10 Aliphatics

R.T.: 13.373 min  
 Delta R.T.: -0.001 min  
 Response: 458724925  
 Conc: 3681.21 m

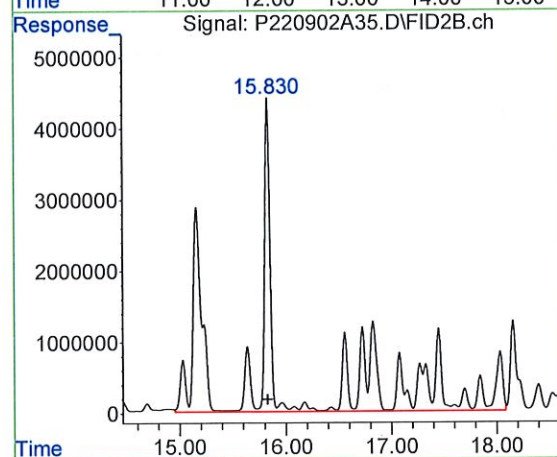

#14 > C10 - C12 Aliphatics

R.T.: 15.830 min  
 Delta R.T.: 0.000 min  
 Response: 702543749  
 Conc: 5637.83 m

Quantitation Report (QT Reviewed)

Data Path : C:\Projects\Hawaii DOH\2. Laboratory Data\Alpha\Carbon Range Study\L2240634\VPH\NF Data\Aliphatic Data  
 Data File : P220908A07.D  
 Signal(s) : FID2B.ch  
 Acq On : 8 Sep 2022 12:54 pm  
 Operator : PVPH:BAD  
 Sample : I2240634-30d,41,10,0.51,0.05,,w  
 Misc : WG1685081,ICAL19300,VPH-50  
 ALS Vial : 7 Sample Multiplier: 1

Integration File: autoint1.e  
 Quant Time: Sep 16 15:06:12 2022  
 Quant Method : C:\Projects\Aquiver Hawaii\2. Laboratory Data\Alpha\Carbon Range Study\L2240634\VPH\NF Data\NF Ali  
 ... .09152022.m  
 Quant Title : VPH ALIPHATIC  
 QLast Update : Fri Sep 16 09:02:50 2022  
 Response via : Initial Calibration  
 Integrator: ChemStation

Volume Inj. :  
 Signal Phase :  
 Signal Info :

Compound	R.T.	Response	Conc	Units
System Monitoring Compounds				
8) s 2,5-Dibromotoluene-FID	22.452	21754166	538.153	
Spiked Amount	250.000	Recovery = 215.26%		
Target Compounds				
9) A1 C5-C8 Aliphatics	12.148f	95472227	847.988	m
10) A2 C5 - C6 Aliphatics	5.645f	5590013	49.651	m
11) A2 > C6 - C8 Aliphatics	10.887f	26673691	236.917	m
12) A1 > C8-C10 Aliphatics	14.689f	556275720	4464.044	m
13) A2 C8 - C10 Aliphatics	14.689f	507962715	4076.338	m
14) A2 > C10 - C12 Aliphatics	16.426	1840868984	14772.748	m

(f)=RT Delta > 1/2 Window

(m)=manual int.

Quantitation Report (QT Reviewed)

Data Path : C:\Projects\Hawaii DOH\2. Laboratory Data\Alpha\Carbon Range Study\L2240634\VPH\NF Data\Aliphatic Da  
Data File : P220908A07.D  
Signal(s) : FID2B.ch  
Acq On : 8 Sep 2022 12:54 pm  
Operator : PVPH:BAD  
Sample : I2240634-30d,41,10,0.51,0.05,,w  
Misc : WG1685081,ICAL19300,VPH-50  
ALS Vial : 7 Sample Multiplier: 1

Integration File: autoint1.e  
Quant Time: Sep 16 15:06:12 2022  
Quant Method : C:\Projects\Aquiver Hawaii\2. Laboratory Data\Alpha\Carbon Range Study\L2240634\VPH\NF Data\NF A  
... .09152022.m  
Quant Title : VPH ALIPHATIC  
QLast Update : Fri Sep 16 09:02:50 2022  
Response via : Initial Calibration  
Integrator: ChemStation

Volume Inj. :  
Signal Phase :  
Signal Info :

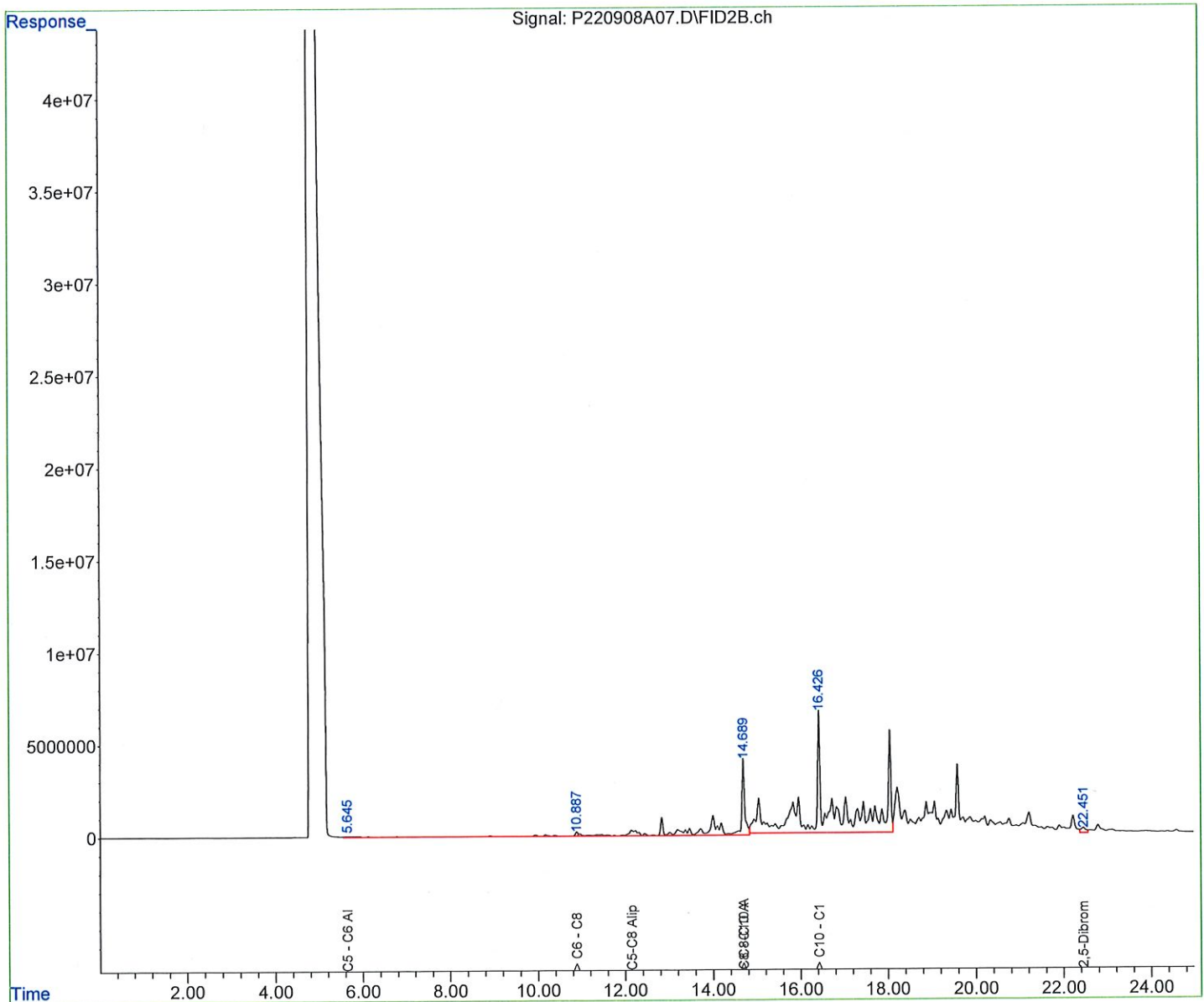

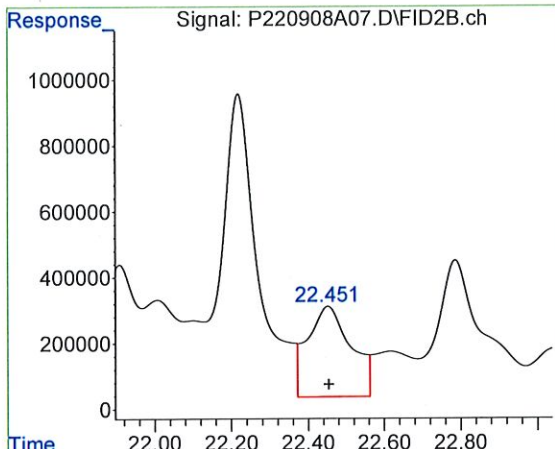

#8 2,5-Dibromotoluene-FID

R.T.: 22.452 min  
 Delta R.T.: -0.002 min  
 Response: 21754166  
 Conc: 538.15

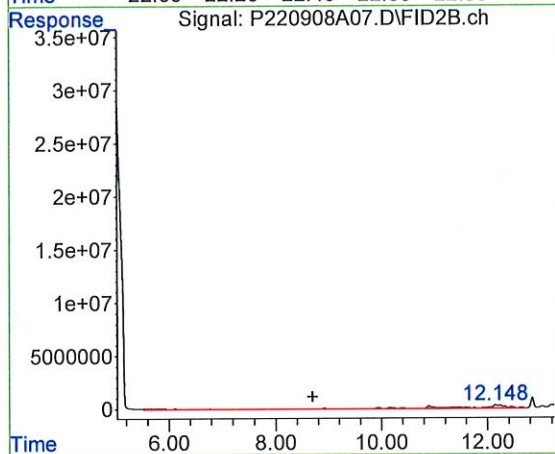

#9 C5-C8 Aliphatics

R.T.: 12.148 min  
 Delta R.T.: 3.454 min  
 Response: 95472227  
 Conc: 847.99 m

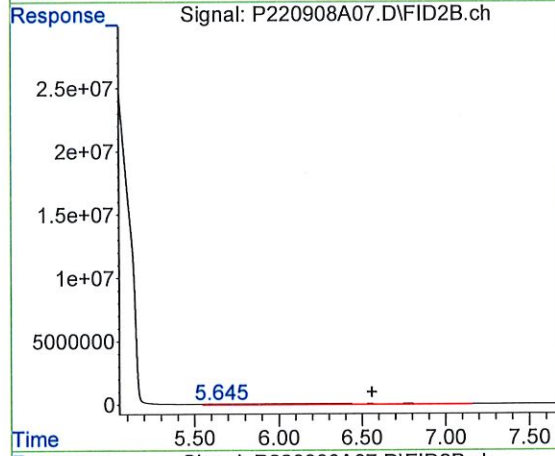

#10 C5 - C6 Aliphatics

R.T.: 5.645 min  
 Delta R.T.: -0.916 min  
 Response: 5590013  
 Conc: 49.65 m

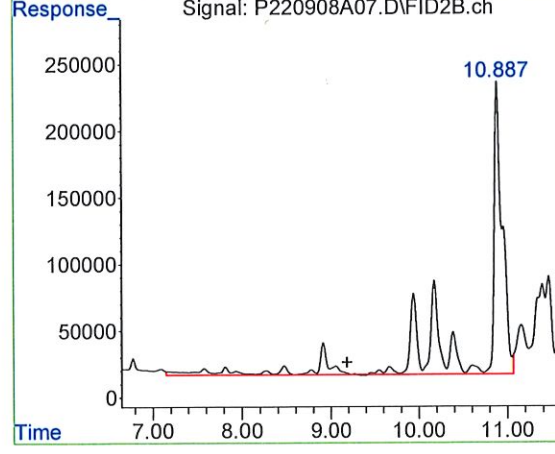

#11 > C6 - C8 Aliphatics

R.T.: 10.887 min  
 Delta R.T.: 1.701 min  
 Response: 26673691  
 Conc: 236.92 m

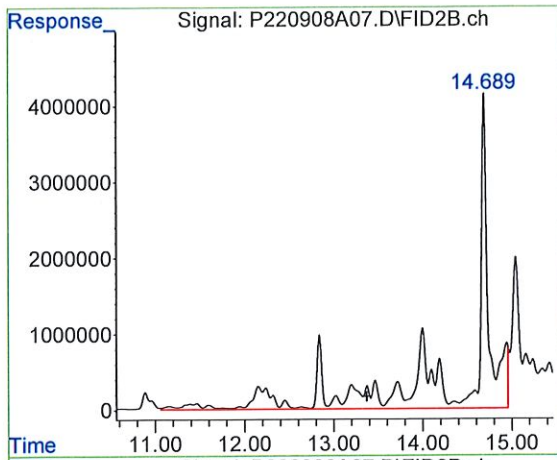

#12 > C8-C10 Aliphatics

R.T.: 14.689 min  
 Delta R.T.: 1.318 min  
 Response: 556275720  
 Conc: 4464.04 m

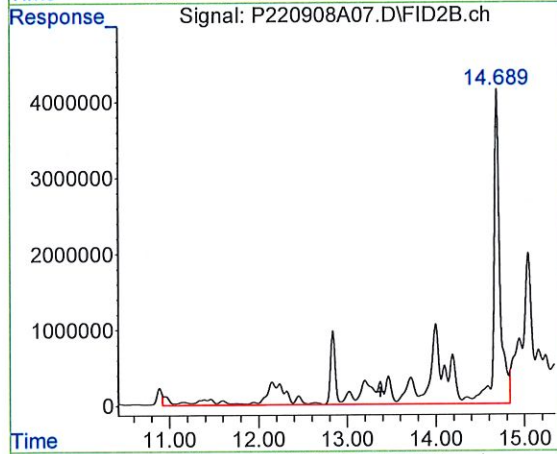

#13 C8 - C10 Aliphatics

R.T.: 14.689 min  
 Delta R.T.: 1.315 min  
 Response: 507962715  
 Conc: 4076.34 m

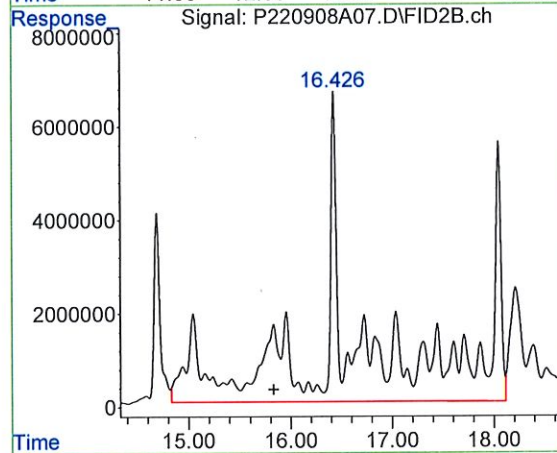

#14 > C10 - C12 Aliphatics

R.T.: 16.426 min  
 Delta R.T.: 0.596 min  
 Response: 1840868984  
 Conc: 14772.75 m

Quantitation Report (QT Reviewed)

Data Path : C:\Projects\Hawaii DOH\2. Laboratory Data\Alpha\Carbon Range Study\L2240634\VPH\NF Data\Aliphatic Data  
 Data File : P220908A09.D  
 Signal(s) : FID2B.ch  
 Acq On : 8 Sep 2022 1:53 pm  
 Operator : PVPH:BAD  
 Sample : I2240634-31d,41,10,0.50,0.05,,w  
 Misc : WG1685081,ICAL19300,VPH-50  
 ALS Vial : 9 Sample Multiplier: 1

Integration File: autoint1.e  
 Quant Time: Sep 16 15:19:25 2022  
 Quant Method : C:\Projects\Aquiver Hawaii\2. Laboratory Data\Alpha\Carbon Range Study\L2240634\VPH\NF Data\NF Ali  
 ... .09152022.m  
 Quant Title : VPH ALIPHATIC  
 QLast Update : Fri Sep 16 09:02:50 2022  
 Response via : Initial Calibration  
 Integrator: ChemStation

Volume Inj. :  
 Signal Phase :  
 Signal Info :

Compound	R.T.	Response	Conc Units
<b>System Monitoring Compounds</b>			
8) s 2,5-Dibromotoluene-FID	22.453	16252552	402.054
Spiked Amount	250.000	Recovery = 160.82%	
<b>Target Compounds</b>			
9) A1 C5-C8 Aliphatics	12.142f	724538586	6435.381 m
10) A2 C5 - C6 Aliphatics	5.648f	6097109	54.155 m
11) A2 > C6 - C8 Aliphatics	10.887f	219533316	1949.904 m
12) A1 > C8-C10 Aliphatics	13.373	1699941144	13641.819 m
13) A2 C8 - C10 Aliphatics	13.373	1616382725	12971.273 m
14) A2 > C10 - C12 Aliphatics	15.829	1095003172	8787.266 m

(f)=RT Delta > 1/2 Window (m)=manual int.

Quantitation Report (QT Reviewed)

Data Path : C:\Projects\Hawaii DOH\2. Laboratory Data\Alpha\Carbon Range Study\L2240634\VPH\NF Data\Aliphatic Da  
Data File : P220908A09.D  
Signal(s) : FID2B.ch  
Acq On : 8 Sep 2022 1:53 pm  
Operator : PVPH:BAD  
Sample : I2240634-31d,41,10,0.50,0.05,,w  
Misc : WG1685081,ICAL19300,VPH-50  
ALS Vial : 9 Sample Multiplier: 1

Integration File: autoint1.e  
Quant Time: Sep 16 15:19:25 2022  
Quant Method : C:\Projects\Aquiver Hawaii\2. Laboratory Data\Alpha\Carbon Range Study\L2240634\VPH\NF Data\NF A  
... .09152022.m  
Quant Title : VPH ALIPHATIC  
QLast Update : Fri Sep 16 09:02:50 2022  
Response via : Initial Calibration  
Integrator: ChemStation

Volume Inj. :  
Signal Phase :  
Signal Info :

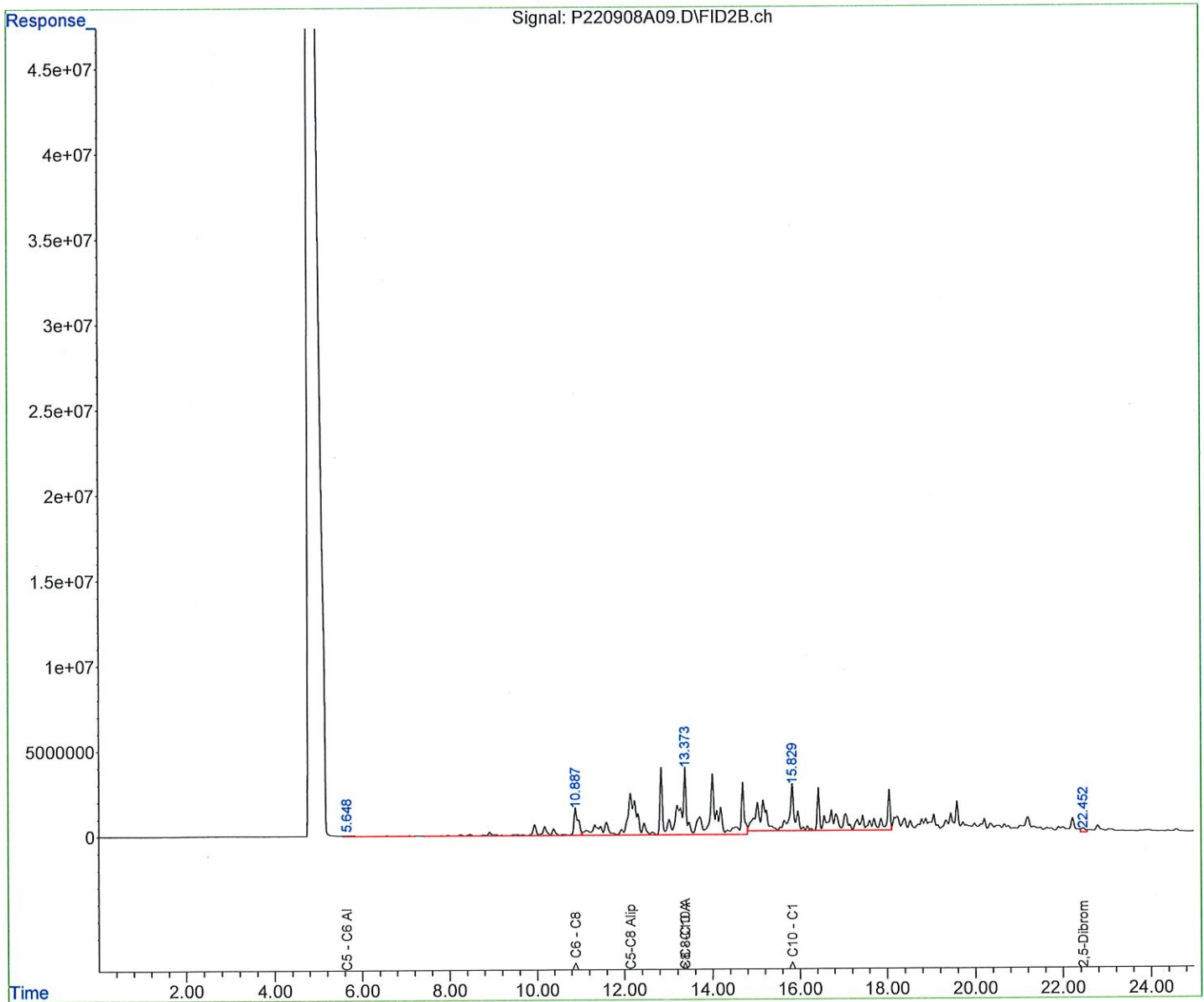



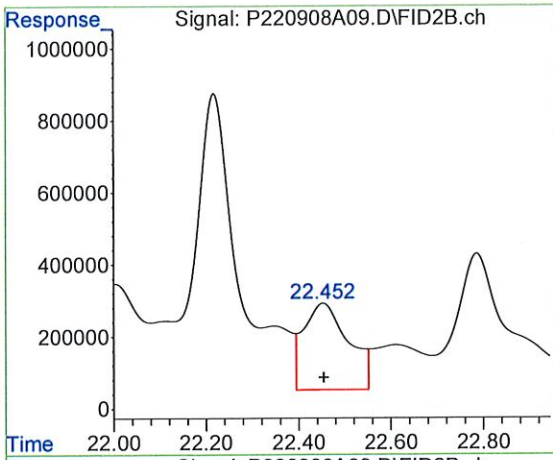

#8 2,5-Dibromotoluene-FID

R.T.: 22.453 min  
 Delta R.T.: 0.000 min  
 Response: 16252552  
 Conc: 402.05

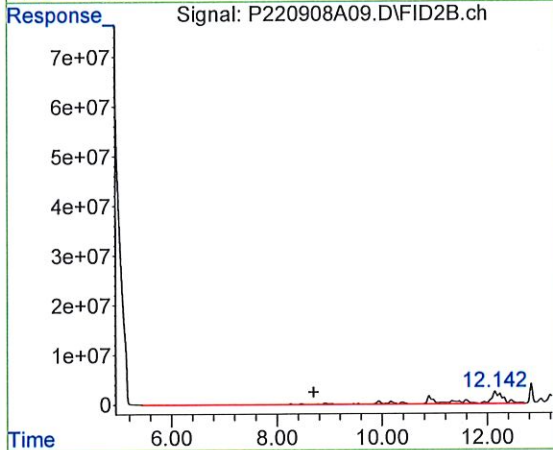

#9 C5-C8 Aliphatics

R.T.: 12.142 min  
 Delta R.T.: 3.448 min  
 Response: 724538586  
 Conc: 6435.38 m

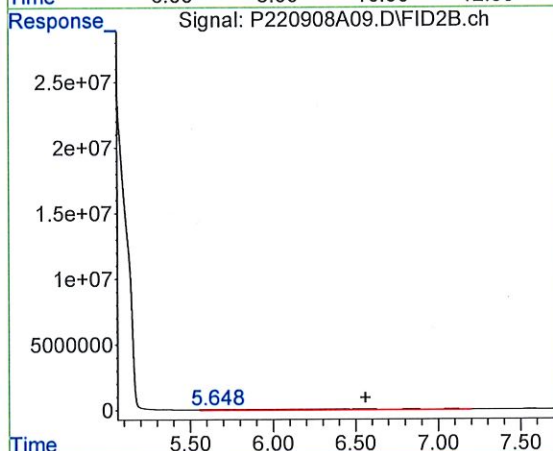

#10 C5 - C6 Aliphatics

R.T.: 5.648 min  
 Delta R.T.: -0.913 min  
 Response: 6097109  
 Conc: 54.15 m

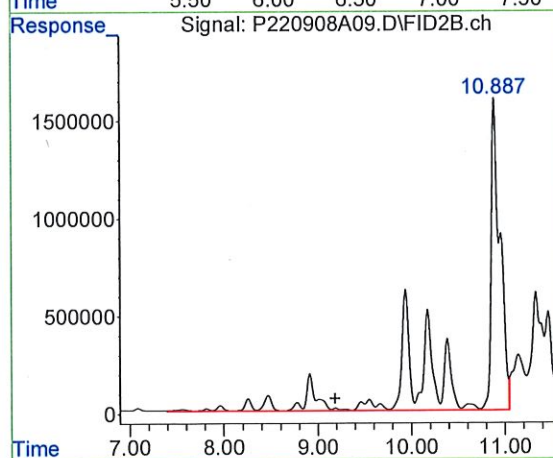

#11 > C6 - C8 Aliphatics

R.T.: 10.887 min  
 Delta R.T.: 1.701 min  
 Response: 219533316  
 Conc: 1949.90 m

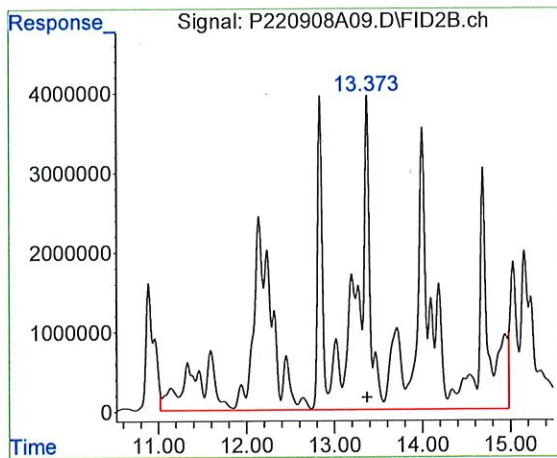

#12 > C8-C10 Aliphatics

R.T.: 13.373 min  
 Delta R.T.: 0.002 min  
 Response: 1699941144  
 Conc: 13641.82 m

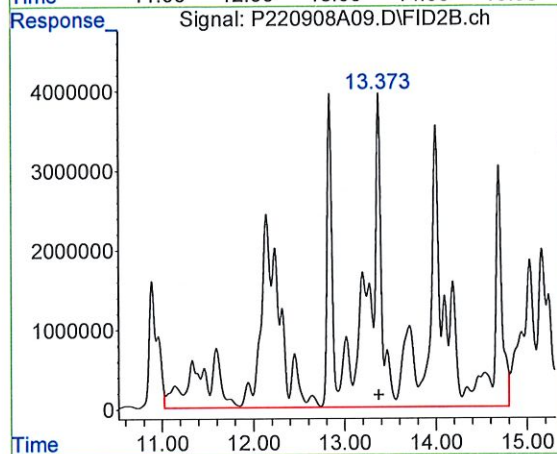

#13 C8 - C10 Aliphatics

R.T.: 13.373 min  
 Delta R.T.: -0.001 min  
 Response: 1616382725  
 Conc: 12971.27 m

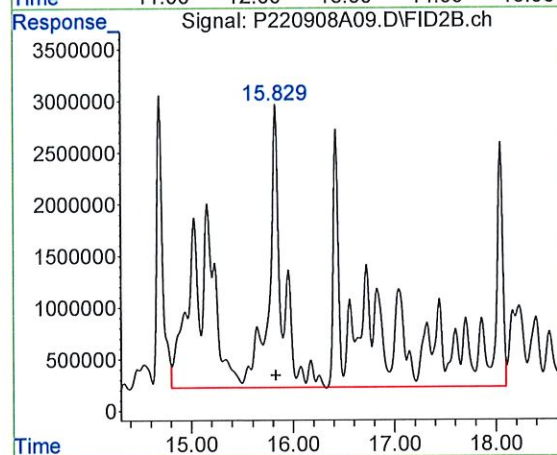

#14 > C10 - C12 Aliphatics

R.T.: 15.829 min  
 Delta R.T.: 0.000 min  
 Response: 1095003172  
 Conc: 8787.27 m

## Attachment F: TPH Quantitation Raw Data Reports

Quantitation Report (QT Reviewed)

Data Path : C:\Projects\Hawaii DOH\2. Laboratory Data\Alpha\Carbon Range Study\L2240634\TPH\NF TPH\  
 Data File : f1708172212.D  
 Signal(s) : FID1A.CH  
 Acq On : 17 Aug 2022 19:40 pm  
 Operator : FID17:WR  
 Sample : WG1676301-1,42,,  
 Misc : WG1676467,WG1676301,ICAL18753  
 ALS Vial : 6 Sample Multiplier: 1

Integration File: autoint1.e  
 Quant Time: Oct 23 16:37:45 2022  
 Quant Method : C:\Projects\Hawaii DOH\2. Laboratory Data\Alpha\Carbon Range Study\L2240634\TPH\NF TPH\NF TPH (   
 Quant Title : FID Forensics  
 QLast Update : Fri Sep 23 15:53:13 2022  
 Response via : Initial Calibration  
 Integrator: ChemStation 6890 Scale Mode: Large solvent peaks clipped

Volume Inj. :  
 Signal Phase :  
 Signal Info :

Compound	R.T.	Response	Conc Units
Internal Standards			
1) I 5-alpha-androstane	30.266	59394365	50.000 ug/mLm
System Monitoring Compounds			
2) s ortho-terphenyl	28.290	63504659	51.145 ug/mLm
Spiked Amount	50.000	Range 50 - 130	Recovery = 102.29%
3) s d50-Tetracosane	35.019	49108277	50.020 ug/mLm
Spiked Amount	50.000	Range 50 - 130	Recovery = 100.04%
Target Compounds			
4) h > C8 to C10 Aliphatics	7.072	1364421	1.219 ug/mLm
5) h > C10 to C12 Aliphatics	11.977	1105234	0.988 ug/mlm
6) h > C12 to C16 Aliphatics	16.687	2063524	1.844 UG/MLm
7) h > C16 to C21 Aliphatics	28.293	17976833	16.065 UG/MLm
8) h > C21 to C32 Aliphatics	32.798	27247290	24.350 UG/MLm

SemiQuant Compounds - Not Calibrated on this Instrument

(f)=RT Delta > 1/2 Window (m)=manual int.

Quantitation Report (QT Reviewed)

Data Path : C:\Projects\Hawaii DOH\2. Laboratory Data\Alpha\Carbon Range Study\L2240634\TPH\NF TPH\  
Data File : f1708172212.D  
Signal(s) : FID1A.CH  
Acq On : 17 Aug 2022 19:40 pm  
Operator : FID17:WR  
Sample : WG1676301-1,42,,  
Misc : WG1676467,WG1676301,ICAL18753  
ALS Vial : 6 Sample Multiplier: 1

Integration File: autoint1.e  
Quant Time: Oct 23 16:37:45 2022  
Quant Method : C:\Projects\Hawaii DOH\2. Laboratory Data\Alpha\Carbon Range Study\L2240634\TPH\NF TPH\NF TPH  
Quant Title : FID Forensics  
QLast Update : Fri Sep 23 15:53:13 2022  
Response via : Initial Calibration  
Integrator: ChemStation 6890 Scale Mode: Large solvent peaks clipped

Volume Inj. :  
Signal Phase :  
Signal Info :

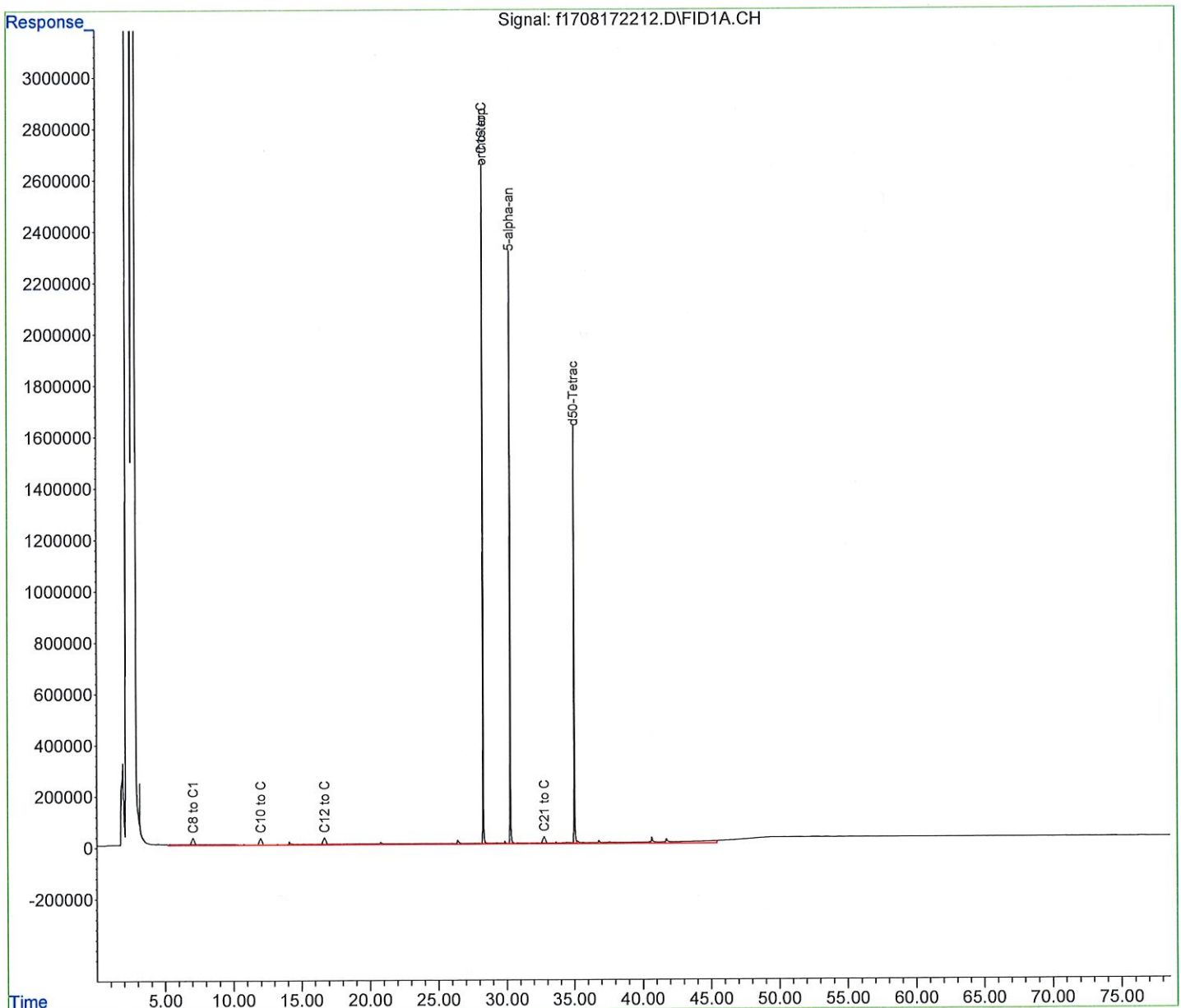

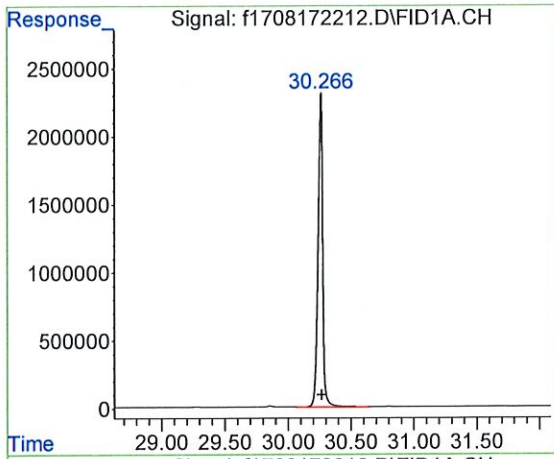

#1 5-alpha-androstane  
R.T.: 30.266 min  
Delta R.T.: -0.004 min  
Response: 59394365  
Conc: 50.00 ug/mL m

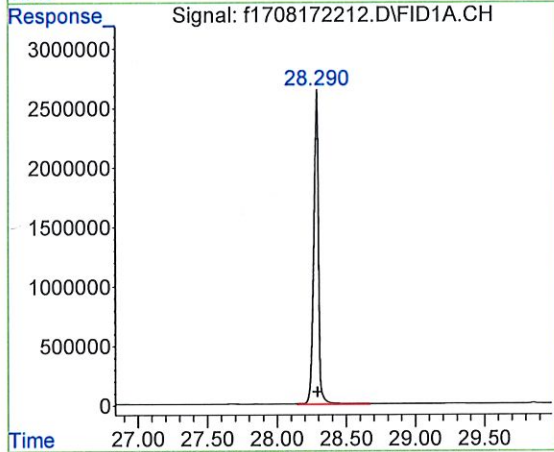

#2 ortho-terphenyl  
R.T.: 28.290 min  
Delta R.T.: -0.003 min  
Response: 63504659  
Conc: 51.14 ug/mL m

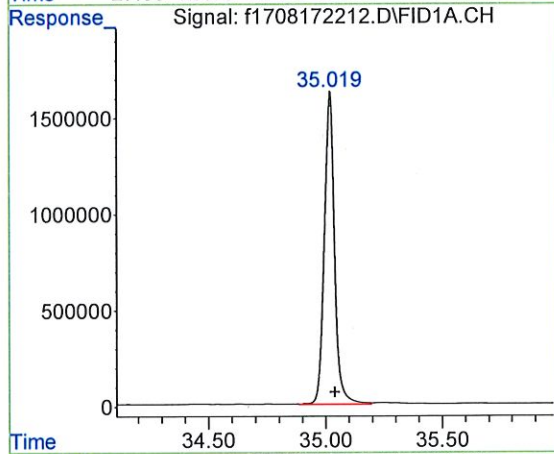

#3 d50-Tetracosane  
R.T.: 35.019 min  
Delta R.T.: -0.020 min  
Response: 49108277  
Conc: 50.02 ug/mL m

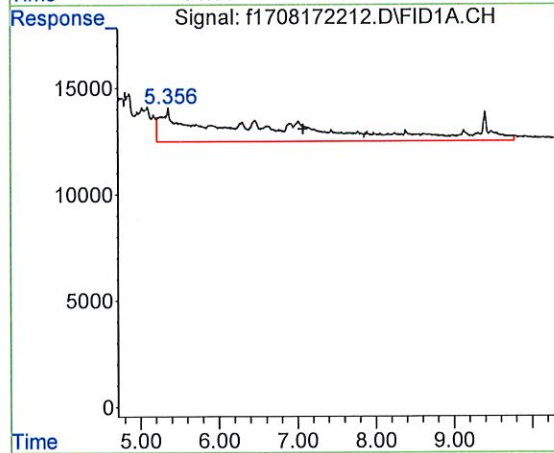

#4 > C8 to C10 Aliphatics  
R.T.: 7.072 min  
Delta R.T.: 0.000 min  
Response: 1364421  
Conc: 1.22 ug/mL m

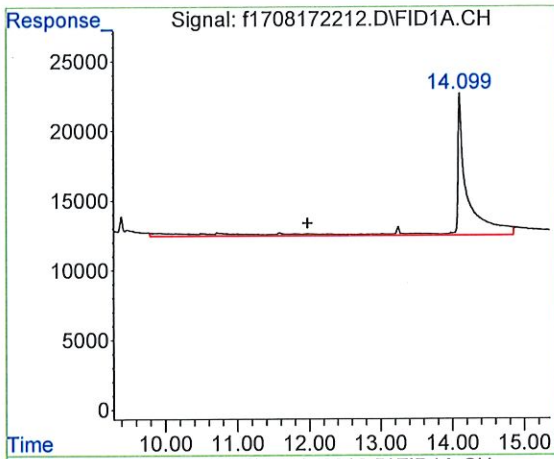

#5 > C10 to C12 Aliphatics

R.T.: 11.977 min  
 Delta R.T.: 0.000 min  
 Response: 1105234  
 Conc: 0.99 ug/ml m

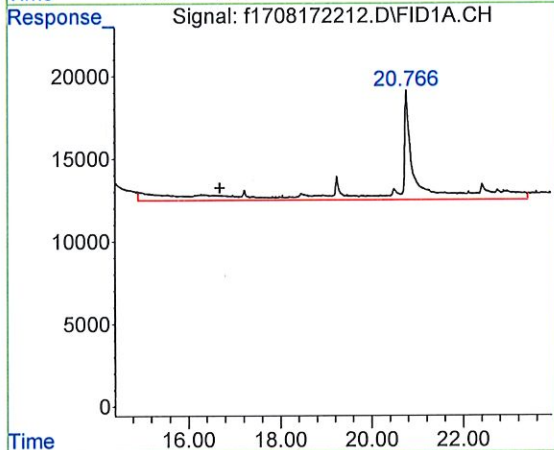

#6 > C12 to C16 Aliphatics

R.T.: 16.687 min  
 Delta R.T.: 0.000 min  
 Response: 2063524  
 Conc: 1.84 UG/ML m

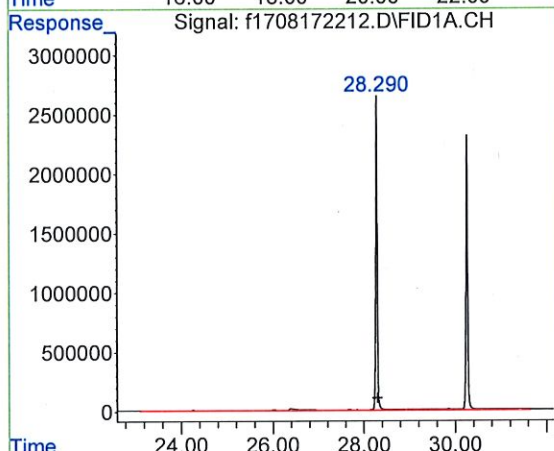

#7 > C16 to C21 Aliphatics

R.T.: 28.293 min  
 Delta R.T.: 0.000 min  
 Response: 17976833  
 Conc: 16.07 UG/ML m

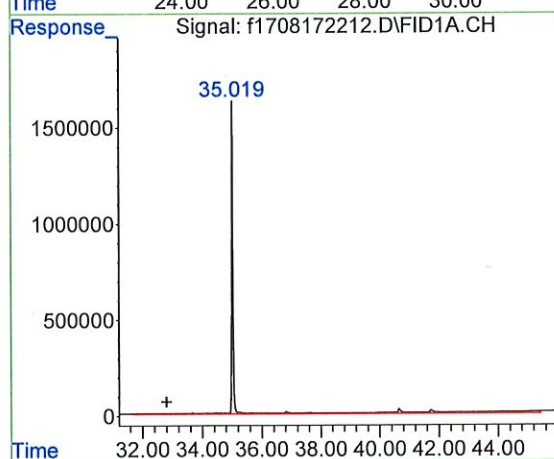

#8 > C21 to C32 Aliphatics

R.T.: 32.798 min  
 Delta R.T.: 0.000 min  
 Response: 27247290  
 Conc: 24.35 UG/ML m

Quantitation Report (QT Reviewed)

Data Path : C:\Projects\Hawaii DOH\2. Laboratory Data\Alpha\Carbon Range Study\L2240634\TPH\NF TPH\  
 Data File : f1708172220.D  
 Signal(s) : FID1A.CH  
 Acq On : 18 Aug 2022 1:41 am  
 Operator : FID17:WR  
 Sample : L2240634-01,42,,  
 Misc : WG1676467,WG1676301,ICAL18753  
 ALS Vial : 10 Sample Multiplier: 1

Integration File: autoint1.e  
 Quant Time: Oct 23 16:45:45 2022  
 Quant Method : C:\Projects\Hawaii DOH\2. Laboratory Data\Alpha\Carbon Range Study\L2240634\TPH\NF TPH\NF TPH ( )  
 Quant Title : FID Forensics  
 QLast Update : Fri Sep 23 15:53:13 2022  
 Response via : Initial Calibration  
 Integrator: ChemStation 6890 Scale Mode: Large solvent peaks clipped

Volume Inj. :  
 Signal Phase :  
 Signal Info :

Compound	R.T.	Response	Conc Units
Internal Standards			
1) I 5-alpha-androstane	30.263	62914638	50.000 ug/mLm
System Monitoring Compounds			
2) s ortho-terphenyl	28.289	67077447	50.999 ug/mLm
Spiked Amount	50.000	Range 50 - 130	Recovery = 102.00%
3) s d50-Tetracosane	35.024	51803250	49.813 ug/mLm
Spiked Amount	50.000	Range 50 - 130	Recovery = 99.63%
Target Compounds			
4) h > C8 to C10 Aliphatics	7.072	1140268388	961.985 ug/mLm
5) h > C10 to C12 Aliphatics	11.977	354604380	299.161 ug/mlm
6) h > C12 to C16 Aliphatics	16.687	65383861	55.161 UG/MLm
7) h > C16 to C21 Aliphatics	28.293	16180616	13.651 UG/MLm
8) h > C21 to C32 Aliphatics	32.798	29067199	24.522 UG/MLm

SemiQuant Compounds - Not Calibrated on this Instrument

(f)=RT Delta > 1/2 Window (m)=manual int.



Quantitation Report (QT Reviewed)

Data Path : C:\Projects\Hawaii DOH\2. Laboratory Data\Alpha\Carbon Range Study\L2240634\TPH\NF TPH\  
Data File : f1708172220.D  
Signal(s) : FID1A.CH  
Acq On : 18 Aug 2022 1:41 am  
Operator : FID17:WR  
Sample : L2240634-01,42,,  
Misc : WG1676467,WG1676301,ICAL18753  
ALS Vial : 10 Sample Multiplier: 1

Integration File: autoint1.e  
Quant Time: Oct 23 16:45:45 2022  
Quant Method : C:\Projects\Hawaii DOH\2. Laboratory Data\Alpha\Carbon Range Study\L2240634\TPH\NF TPH\NF TPH  
Quant Title : FID Forensics  
QLast Update : Fri Sep 23 15:53:13 2022  
Response via : Initial Calibration  
Integrator: ChemStation 6890 Scale Mode: Large solvent peaks clipped

Volume Inj. :  
Signal Phase :  
Signal Info :

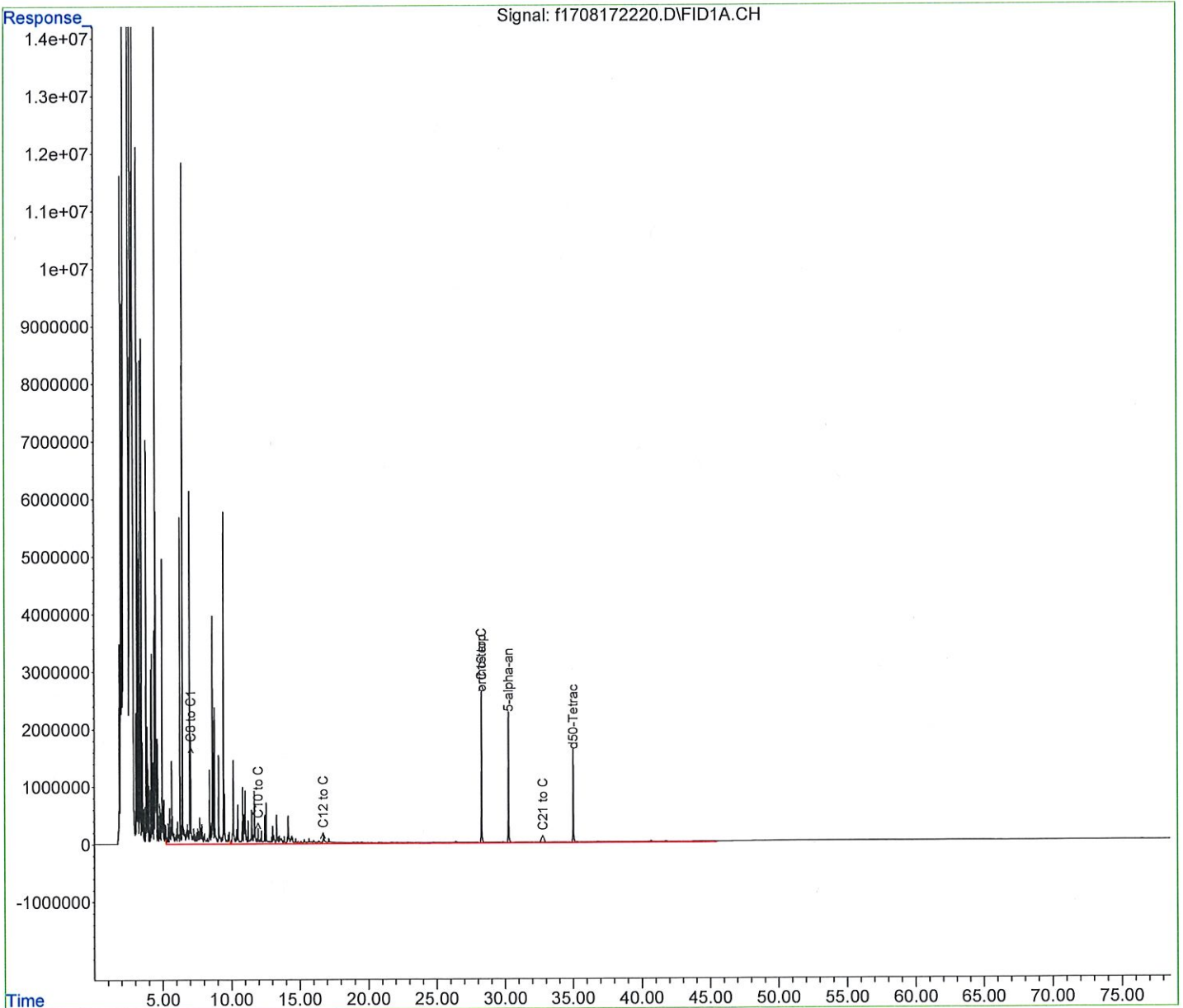

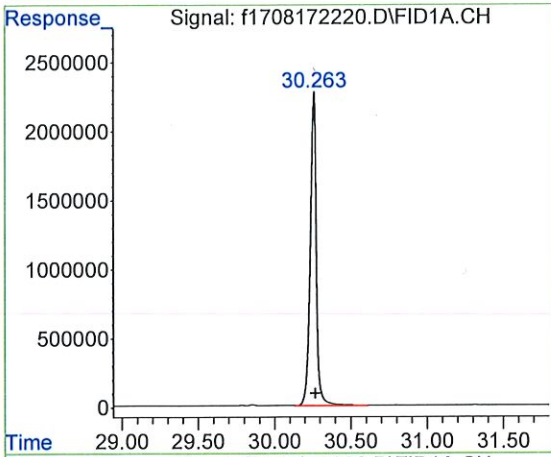

#1 5-alpha-androstane  
 R.T.: 30.263 min  
 Delta R.T.: -0.006 min  
 Response: 62914638  
 Conc: 50.00 ug/mL m

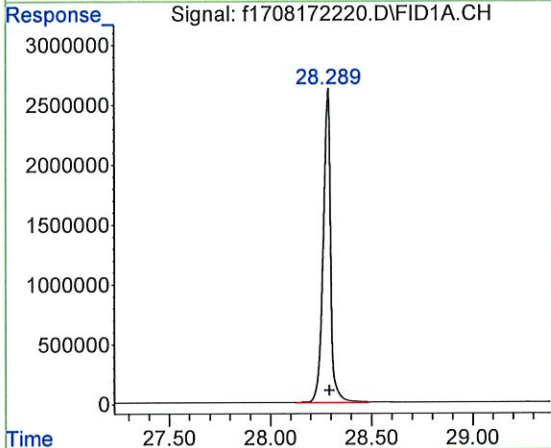

#2 ortho-terphenyl  
 R.T.: 28.289 min  
 Delta R.T.: -0.004 min  
 Response: 67077447  
 Conc: 51.00 ug/mL m

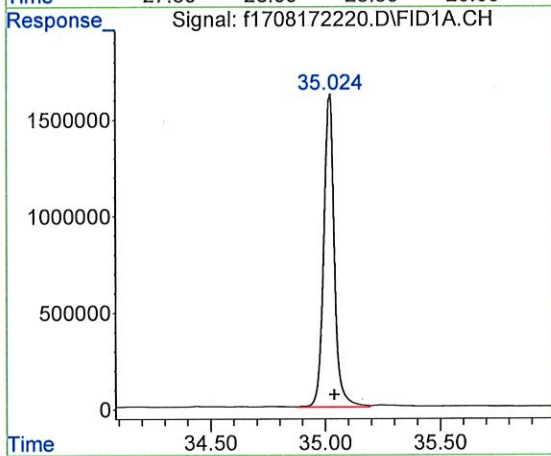

#3 d50-Tetracosane  
 R.T.: 35.024 min  
 Delta R.T.: -0.015 min  
 Response: 51803250  
 Conc: 49.81 ug/mL m

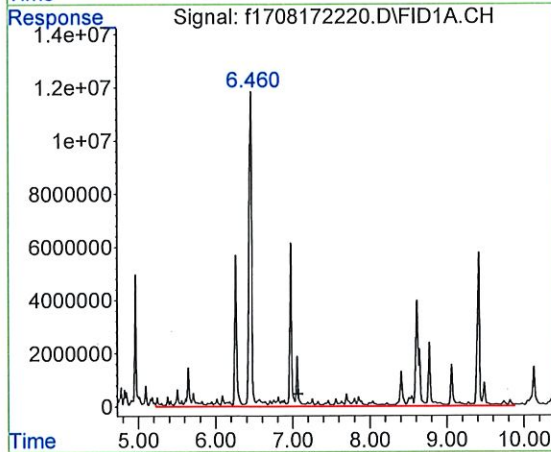

#4 > C8 to C10 Aliphatics  
 R.T.: 7.072 min  
 Delta R.T.: 0.000 min  
 Response: 1140268388  
 Conc: 961.99 ug/mL m

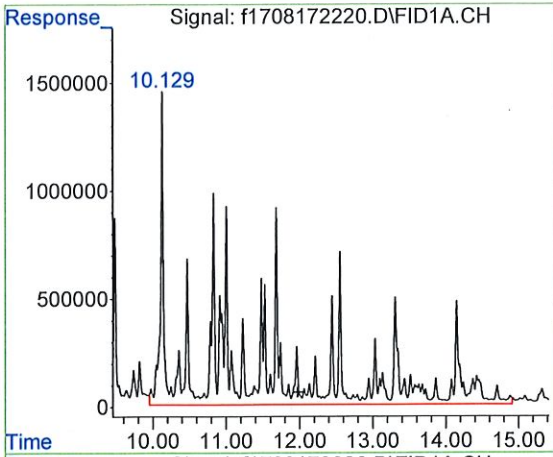

#5 > C10 to C12 Aliphatics  
 R.T.: 11.977 min  
 Delta R.T.: 0.000 min  
 Response: 354604380  
 Conc: 299.16 ug/ml m

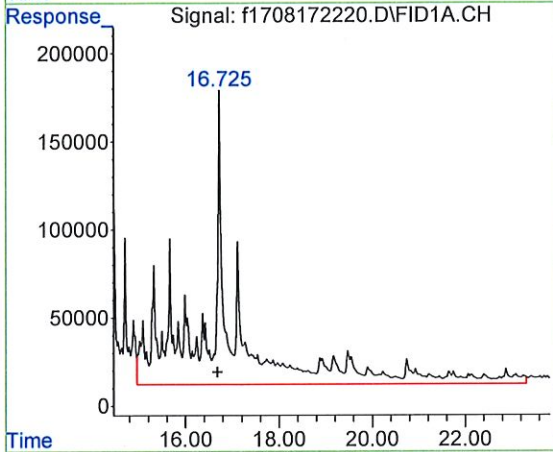

#6 > C12 to C16 Aliphatics  
 R.T.: 16.687 min  
 Delta R.T.: 0.000 min  
 Response: 65383861  
 Conc: 55.16 UG/ML m

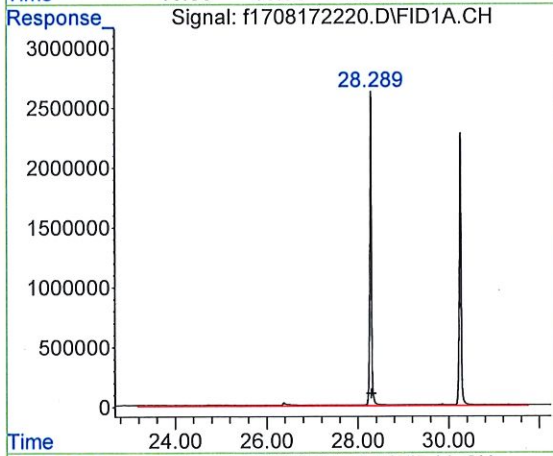

#7 > C16 to C21 Aliphatics  
 R.T.: 28.293 min  
 Delta R.T.: 0.000 min  
 Response: 16180616  
 Conc: 13.65 UG/ML m

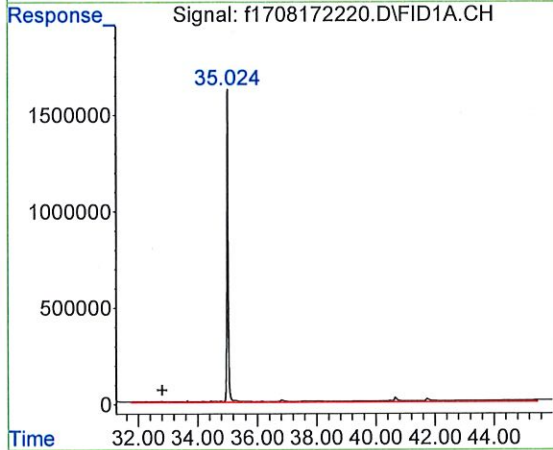

#8 > C21 to C32 Aliphatics  
 R.T.: 32.798 min  
 Delta R.T.: 0.000 min  
 Response: 29067199  
 Conc: 24.52 UG/ML m

Quantitation Report (QT Reviewed)

Data Path : C:\Projects\Hawaii DOH\2. Laboratory Data\Alpha\Carbon Range Study\L2240634\TPH\NF TPH\  
Data File : f1708172222.D  
Signal(s) : FID1A.CH  
Acq On : 18 Aug 2022 3:10 am  
Operator : FID17:WR  
Sample : WG1676301-4,42,,  
Misc : WG1676467,WG1676301,ICAL18753  
ALS Vial : 11 Sample Multiplier: 1

Integration File: autoint1.e  
Quant Time: Oct 23 16:51:17 2022  
Quant Method : C:\Projects\Hawaii DOH\2. Laboratory Data\Alpha\Carbon Range Study\L2240634\TPH\NF TPH\NF TPH (   
Quant Title : FID Forensics  
QLast Update : Fri Sep 23 15:53:13 2022  
Response via : Initial Calibration  
Integrator: ChemStation 6890 Scale Mode: Large solvent peaks clipped

Volume Inj. :  
Signal Phase :  
Signal Info :

Compound	R.T.	Response	Conc Units
-----			
Internal Standards			
1) I 5-alpha-androstane	30.266	60681820	50.000 ug/mLm

System Monitoring Compounds			
2) s ortho-terphenyl	28.288	64853135	51.122 ug/mLm
Spiked Amount	50.000	Range 50 - 130	Recovery = 102.24%
3) s d50-Tetracosane	35.022	50427755	50.274 ug/mLm
Spiked Amount	50.000	Range 50 - 130	Recovery = 100.55%

Target Compounds			
4) h > C8 to C10 Aliphatics	7.072	1049161063	917.691 ug/mLm
5) h > C10 to C12 Aliphatics	11.977	323945728	283.352 ug/mlm
6) h > C12 to C16 Aliphatics	16.687	60603128	53.009 UG/MLm
7) h > C16 to C21 Aliphatics	28.293	15274127	13.360 UG/MLm
8) h > C21 to C32 Aliphatics	32.798	28156051	24.628 UG/MLm

SemiQuant Compounds - Not Calibrated on this Instrument

(f)=RT Delta > 1/2 Window

(m)=manual int.

Quantitation Report (QT Reviewed)

Data Path : C:\Projects\Hawaii DOH\2. Laboratory Data\Alpha\Carbon Range Study\L2240634\TPH\NF TPH\  
Data File : f1708172222.D  
Signal(s) : FID1A.CH  
Acq On : 18 Aug 2022 3:10 am  
Operator : FID17:WR  
Sample : WG1676301-4,42,,  
Misc : WG1676467,WG1676301,ICAL18753  
ALS Vial : 11 Sample Multiplier: 1

Integration File: autoint1.e  
Quant Time: Oct 23 16:51:17 2022  
Quant Method : C:\Projects\Hawaii DOH\2. Laboratory Data\Alpha\Carbon Range Study\L2240634\TPH\NF TPH\NF TPH  
Quant Title : FID Forensics  
QLast Update : Fri Sep 23 15:53:13 2022  
Response via : Initial Calibration  
Integrator: ChemStation 6890 Scale Mode: Large solvent peaks clipped

Volume Inj. :  
Signal Phase :  
Signal Info :

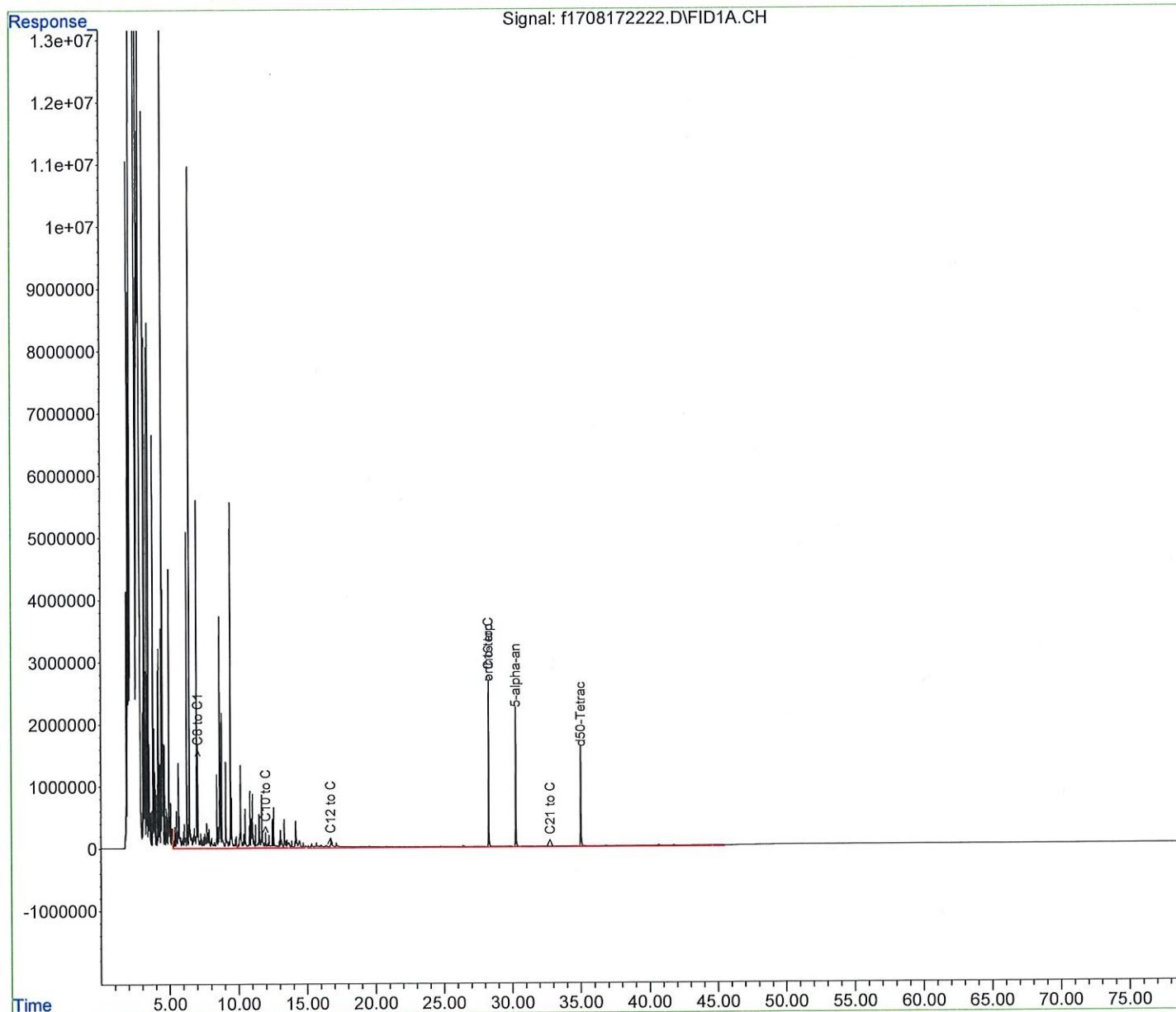

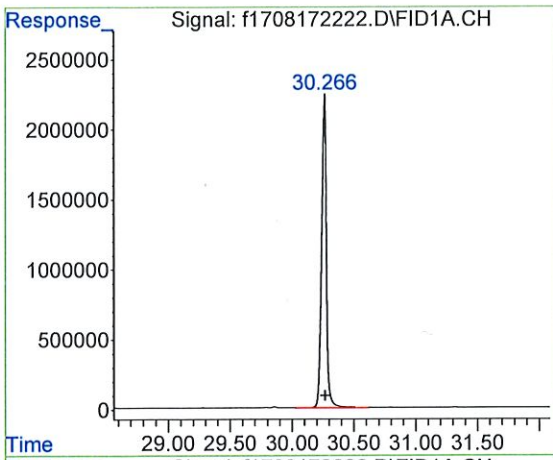

#1 5-alpha-androstane  
 R.T.: 30.266 min  
 Delta R.T.: -0.004 min  
 Response: 60681820  
 Conc: 50.00 ug/mL m

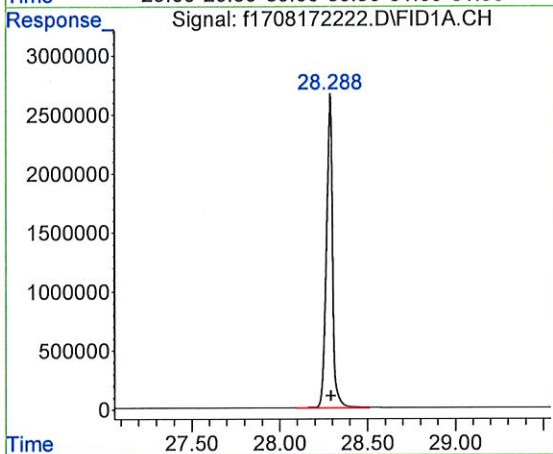

#2 ortho-terphenyl  
 R.T.: 28.288 min  
 Delta R.T.: -0.005 min  
 Response: 64853135  
 Conc: 51.12 ug/mL m

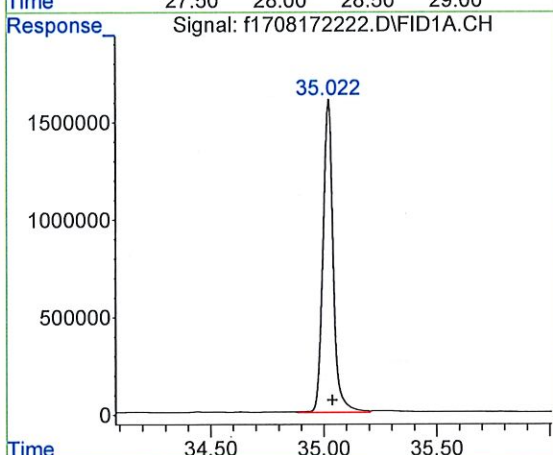

#3 d50-Tetracosane  
 R.T.: 35.022 min  
 Delta R.T.: -0.017 min  
 Response: 50427755  
 Conc: 50.27 ug/mL m

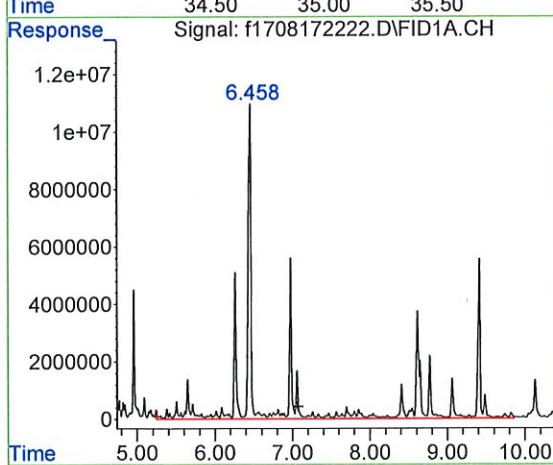

#4 > C8 to C10 Aliphatics  
 R.T.: 7.072 min  
 Delta R.T.: 0.000 min  
 Response: 1049161063  
 Conc: 917.69 ug/mL m

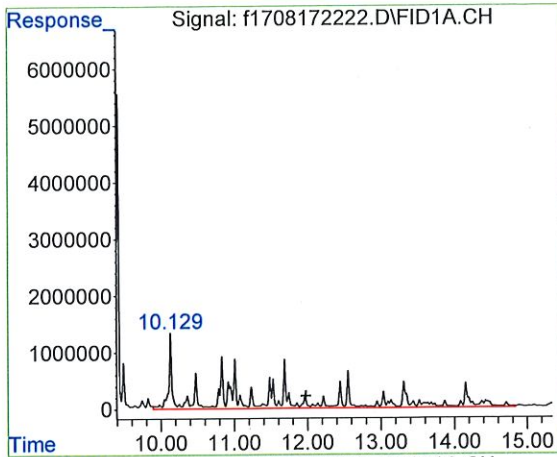

#5 > C10 to C12 Aliphatics

R.T.: 11.977 min  
 Delta R.T.: 0.000 min  
 Response: 323945728  
 Conc: 283.35 ug/ml m

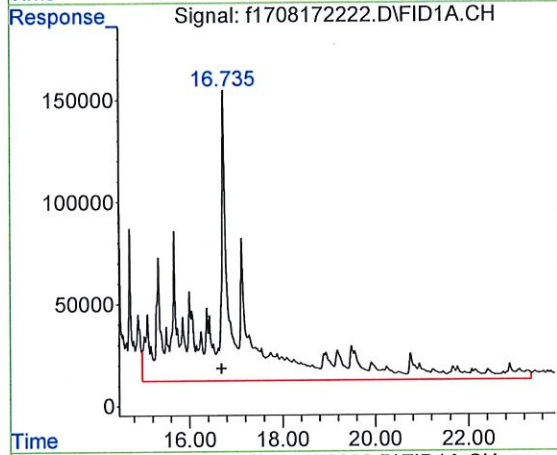

#6 > C12 to C16 Aliphatics

R.T.: 16.687 min  
 Delta R.T.: 0.000 min  
 Response: 60603128  
 Conc: 53.01 UG/ML m

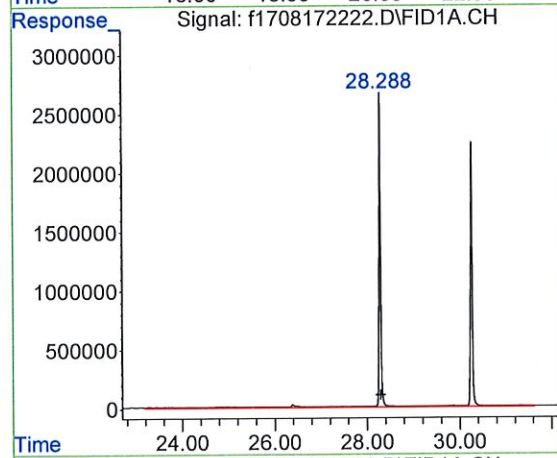

#7 > C16 to C21 Aliphatics

R.T.: 28.293 min  
 Delta R.T.: 0.000 min  
 Response: 15274127  
 Conc: 13.36 UG/ML m

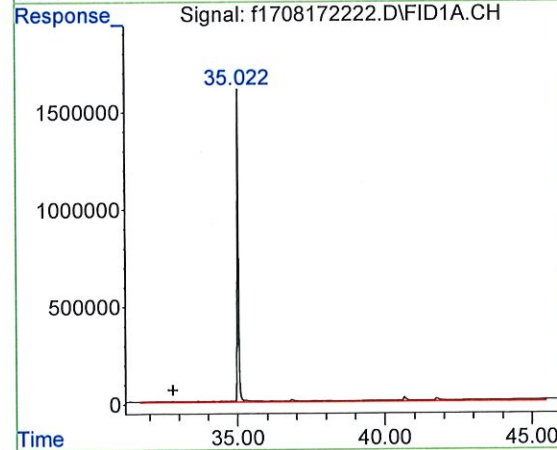

#8 > C21 to C32 Aliphatics

R.T.: 32.798 min  
 Delta R.T.: 0.000 min  
 Response: 28156051  
 Conc: 24.63 UG/ML m

Quantitation Report (QT Reviewed)

Data Path : C:\Projects\Hawaii DOH\2. Laboratory Data\Alpha\Carbon Range Study\L2240634\TPH\NF TPH\  
Data File : f1708172224.D  
Signal(s) : FID1A.CH  
Acq On : 18 Aug 2022 4:40 am  
Operator : FID17:WR  
Sample : L2240634-04,42,,  
Misc : WG1676467,WG1676301,ICAL18753  
ALS Vial : 12 Sample Multiplier: 1

Integration File: autoint1.e  
Quant Time: Oct 23 17:33:14 2022  
Quant Method : C:\Projects\Hawaii DOH\2. Laboratory Data\Alpha\Carbon Range Study\L2240634\TPH\NF TPH\NF TPH (   
Quant Title : FID Forensics  
QLast Update : Fri Sep 23 15:53:13 2022  
Response via : Initial Calibration  
Integrator: ChemStation 6890 Scale Mode: Large solvent peaks clipped

Volume Inj. :  
Signal Phase :  
Signal Info :

Compound	R.T.	Response	Conc Units
Internal Standards			
1) I 5-alpha-androstane	30.265	62919262	50.000 ug/mLm
System Monitoring Compounds			
2) s ortho-terphenyl	28.291	67286922	51.155 ug/mLm
Spiked Amount	50.000	Range 50 - 130	Recovery = 102.31%
3) s d50-Tetracosane	35.020	52130181	50.124 ug/mLm
Spiked Amount	50.000	Range 50 - 130	Recovery = 100.25%
Target Compounds			
4) h > C8 to C10 Aliphatics	7.072	995389305	839.696 ug/mLm
5) h > C10 to C12 Aliphatics	11.977	283823166	239.429 ug/mlm
6) h > C12 to C16 Aliphatics	16.687	50448201	42.557 UG/MLm
7) h > C16 to C21 Aliphatics	28.293	13104180	11.055 UG/MLm
8) h > C21 to C32 Aliphatics	32.798	28029786	23.646 UG/MLm

SemiQuant Compounds - Not Calibrated on this Instrument

(f)=RT Delta > 1/2 Window (m)=manual int.



Quantitation Report (QT Reviewed)

Data Path : C:\Projects\Hawaii DOH\2. Laboratory Data\Alpha\Carbon Range Study\L2240634\TPH\NF TPH\  
Data File : f1708172224.D  
Signal(s) : FID1A.CH  
Acq On : 18 Aug 2022 4:40 am  
Operator : FID17:WR  
Sample : L2240634-04,42,,  
Misc : WG1676467,WG1676301,ICAL18753  
ALS Vial : 12 Sample Multiplier: 1

Integration File: autoint1.e  
Quant Time: Oct 23 17:33:14 2022  
Quant Method : C:\Projects\Hawaii DOH\2. Laboratory Data\Alpha\Carbon Range Study\L2240634\TPH\NF TPH\NF TPH  
Quant Title : FID Forensics  
QLast Update : Fri Sep 23 15:53:13 2022  
Response via : Initial Calibration  
Integrator: ChemStation 6890 Scale Mode: Large solvent peaks clipped

Volume Inj. :  
Signal Phase :  
Signal Info :

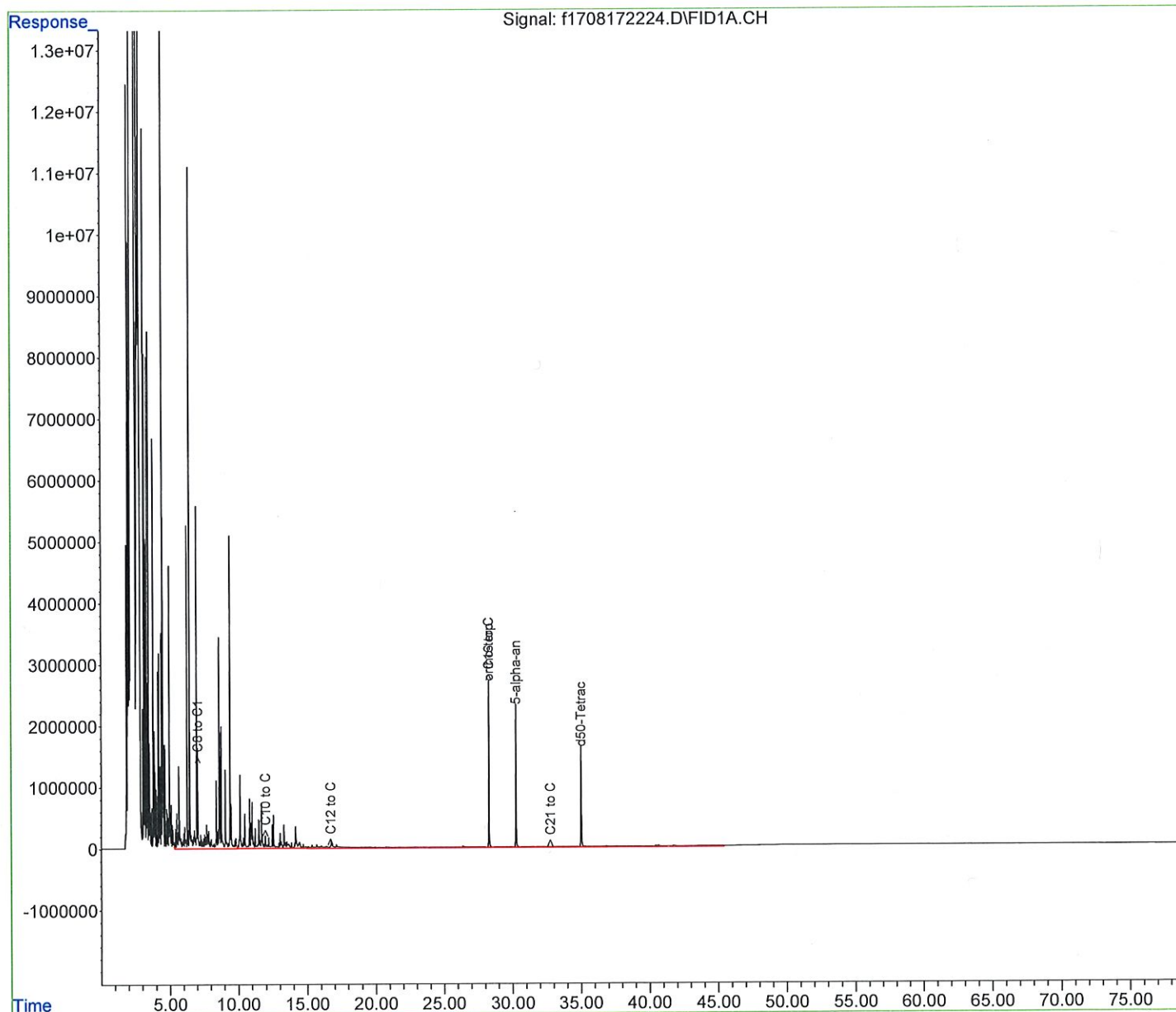

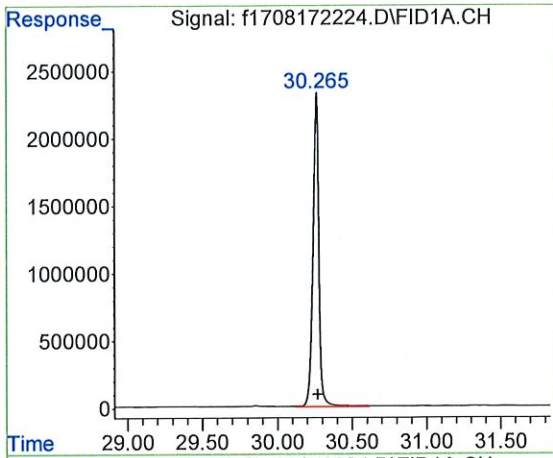

#1 5-alpha-androstane  
 R.T.: 30.265 min  
 Delta R.T.: -0.004 min  
 Response: 62919262  
 Conc: 50.00 ug/mL m

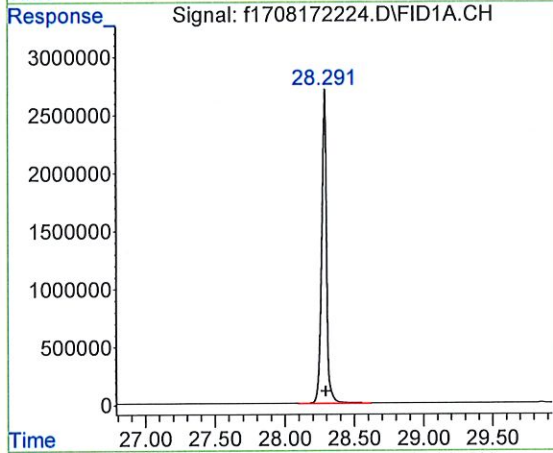

#2 ortho-terphenyl  
 R.T.: 28.291 min  
 Delta R.T.: -0.002 min  
 Response: 67286922  
 Conc: 51.15 ug/mL m

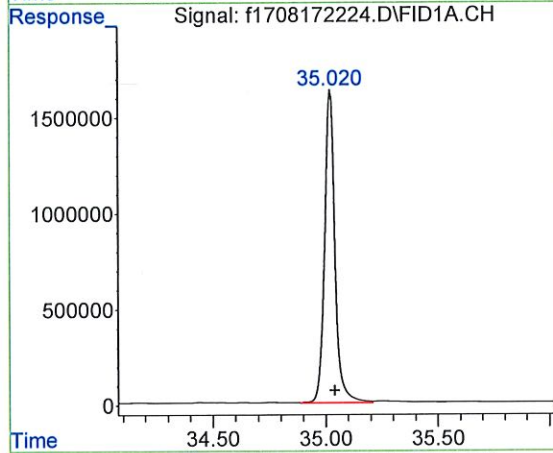

#3 d50-Tetracosane  
 R.T.: 35.020 min  
 Delta R.T.: -0.019 min  
 Response: 52130181  
 Conc: 50.12 ug/mL m

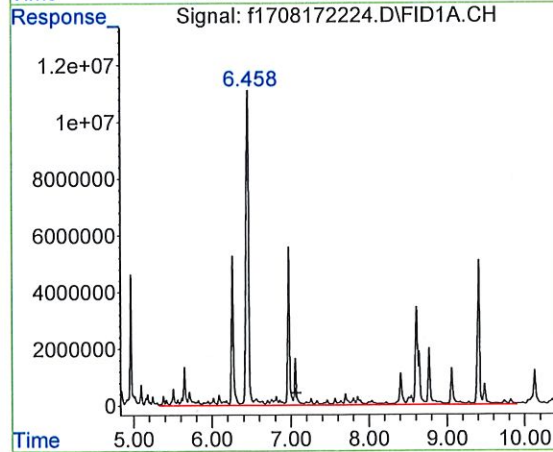

#4 > C8 to C10 Aliphatics  
 R.T.: 7.072 min  
 Delta R.T.: 0.000 min  
 Response: 995389305  
 Conc: 839.70 ug/mL m

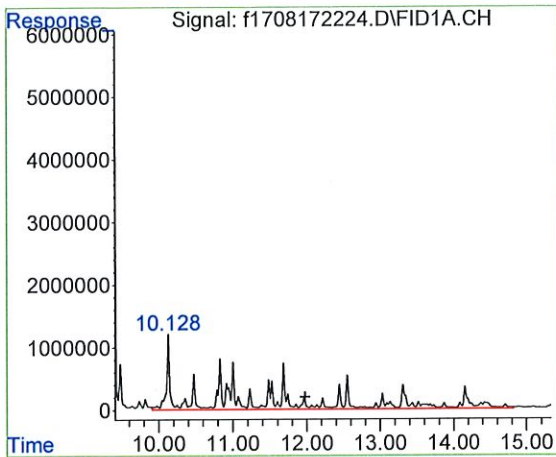

#5 > C10 to C12 Aliphatics

R.T.: 11.977 min  
 Delta R.T.: 0.000 min  
 Response: 283823166  
 Conc: 239.43 ug/ml m

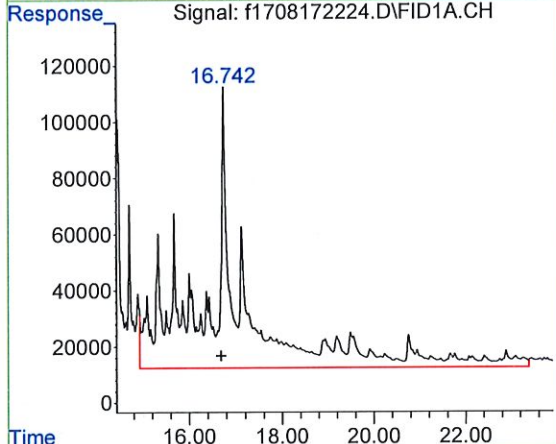

#6 > C12 to C16 Aliphatics

R.T.: 16.687 min  
 Delta R.T.: 0.000 min  
 Response: 50448201  
 Conc: 42.56 UG/ML m

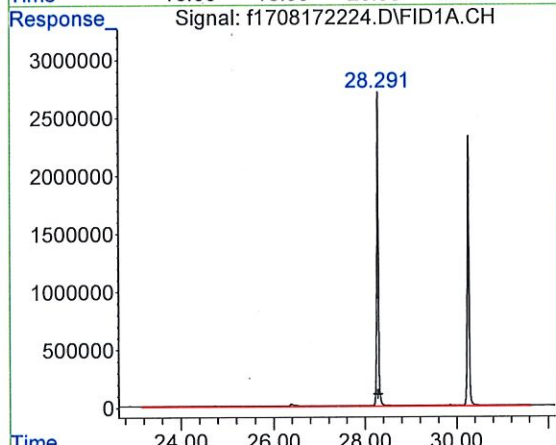

#7 > C16 to C21 Aliphatics

R.T.: 28.293 min  
 Delta R.T.: 0.000 min  
 Response: 13104180  
 Conc: 11.05 UG/ML m

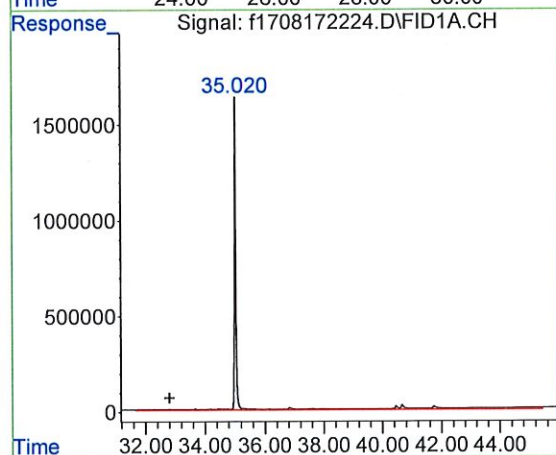

#8 > C21 to C32 Aliphatics

R.T.: 32.798 min  
 Delta R.T.: 0.000 min  
 Response: 28029786  
 Conc: 23.65 UG/ML m

Quantitation Report (QT Reviewed)

Data Path : C:\Projects\Hawaii DOH\2. Laboratory Data\Alpha\Carbon Range Study\L2240634\TPH\NF TPH\  
 Data File : f1708172226.D  
 Signal(s) : FID1A.CH  
 Acq On : 18 Aug 2022 6:10 am  
 Operator : FID17:WR  
 Sample : L2240634-07,42,,  
 Misc : WG1676467,WG1676301,ICAL18753  
 ALS Vial : 13 Sample Multiplier: 1

Integration File: autoint1.e  
 Quant Time: Oct 23 17:43:31 2022  
 Quant Method : C:\Projects\Hawaii DOH\2. Laboratory Data\Alpha\Carbon Range Study\L2240634\TPH\NF TPH\NF TPH (I  
 Quant Title : FID Forensics  
 QLast Update : Fri Sep 23 15:53:13 2022  
 Response via : Initial Calibration  
 Integrator: ChemStation 6890 Scale Mode: Large solvent peaks clipped

Volume Inj. :  
 Signal Phase :  
 Signal Info :

Compound	R.T.	Response	Conc Units
Internal Standards			
1) I 5-alpha-androstane	30.265	66306484	50.000 ug/mLm
System Monitoring Compounds			
2) s ortho-terphenyl	28.292	71426738	51.528 ug/mLm
Spiked Amount	50.000	Range 50 - 130	Recovery = 103.06%
3) s d50-Tetracosane	35.022	55360507	50.510 ug/mLm
Spiked Amount	50.000	Range 50 - 130	Recovery = 101.02%
Target Compounds			
4) h > C8 to C10 Aliphatics	7.072	1149074725	919.825 ug/mLm
5) h > C10 to C12 Aliphatics	11.977	335489692	268.557 ug/mlm
6) h > C12 to C16 Aliphatics	16.687	58193772	46.584 UG/MLm
7) h > C16 to C21 Aliphatics	28.293	14679873	11.751 UG/MLm
8) h > C21 to C32 Aliphatics	32.798	27942125	22.367 UG/MLm

SemiQuant Compounds - Not Calibrated on this Instrument

(f)=RT Delta > 1/2 Window (m)=manual int.

Quantitation Report (QT Reviewed)

Data Path : C:\Projects\Hawaii DOH\2. Laboratory Data\Alpha\Carbon Range Study\L2240634\TPH\NF TPH\  
Data File : f1708172226.D  
Signal(s) : FID1A.CH  
Acq On : 18 Aug 2022 6:10 am  
Operator : FID17:WR  
Sample : L2240634-07,42,,  
Misc : WG1676467,WG1676301,ICAL18753  
ALS Vial : 13 Sample Multiplier: 1

Integration File: autoint1.e  
Quant Time: Oct 23 17:43:31 2022  
Quant Method : C:\Projects\Hawaii DOH\2. Laboratory Data\Alpha\Carbon Range Study\L2240634\TPH\NF TPH\  
Quant Title : FID Forensics  
QLast Update : Fri Sep 23 15:53:13 2022  
Response via : Initial Calibration  
Integrator: ChemStation 6890 Scale Mode: Large solvent peaks clipped

Volume Inj. :  
Signal Phase :  
Signal Info :

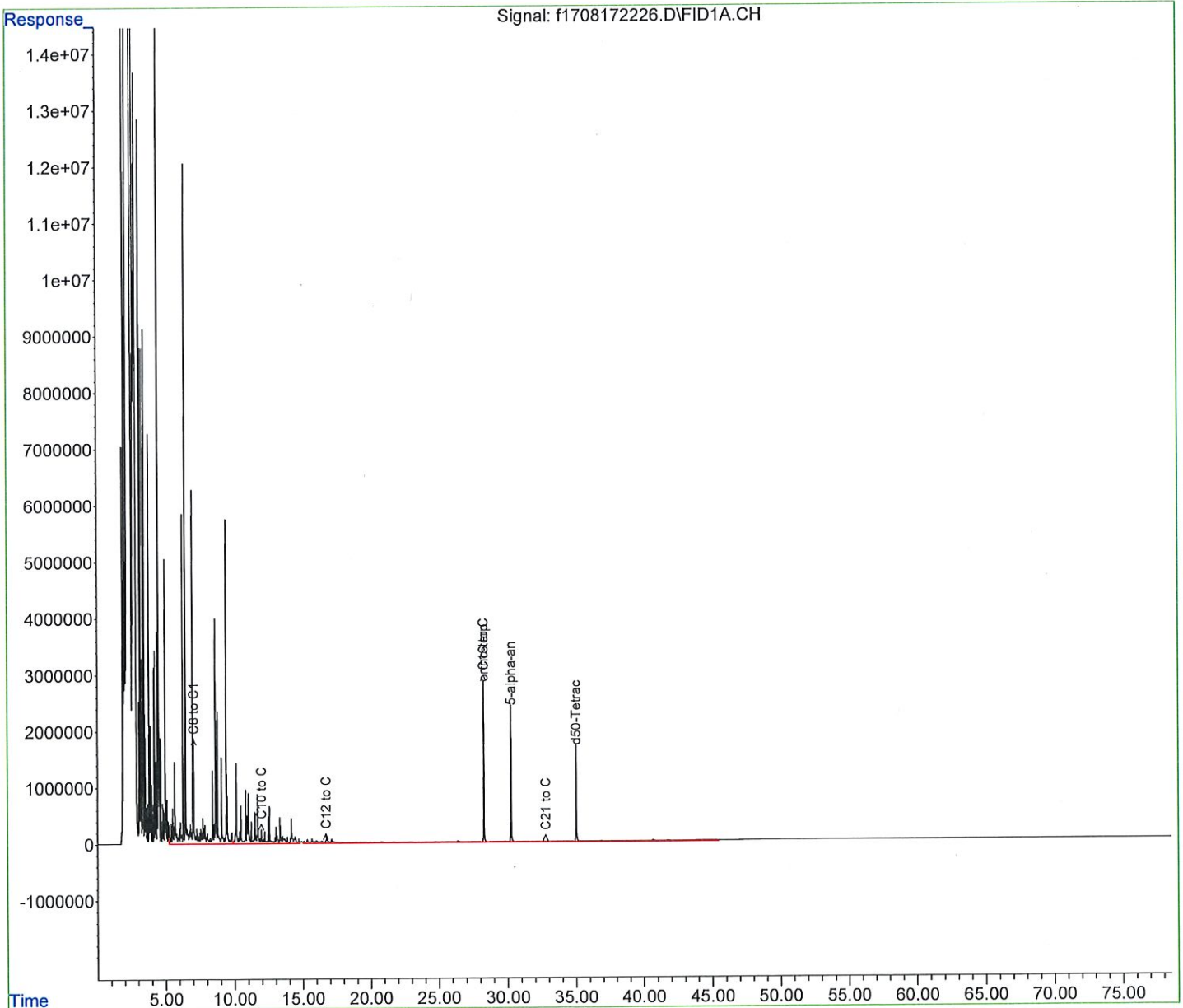

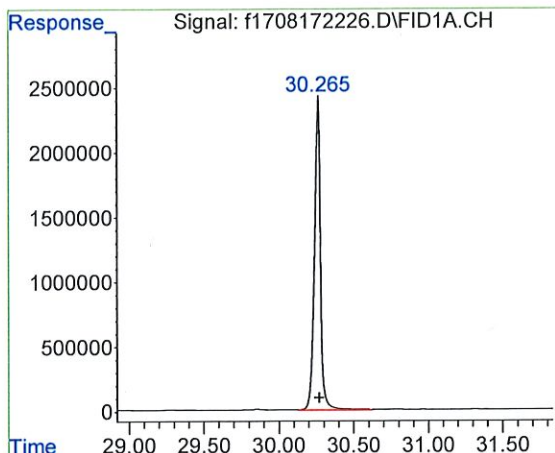

#1 5-alpha-androstane  
 R.T.: 30.265 min  
 Delta R.T.: -0.005 min  
 Response: 66306484  
 Conc: 50.00 ug/mL m

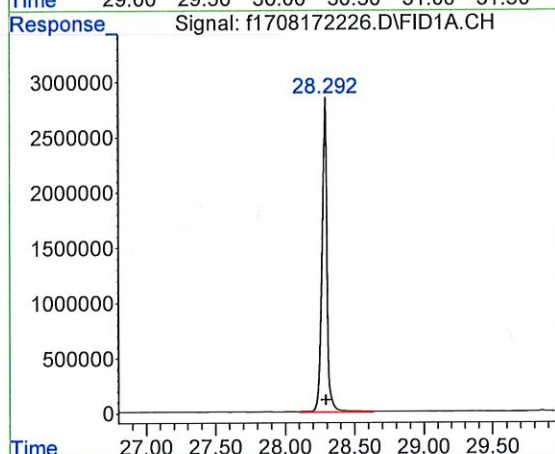

#2 ortho-terphenyl  
 R.T.: 28.292 min  
 Delta R.T.: 0.000 min  
 Response: 71426738  
 Conc: 51.53 ug/mL m

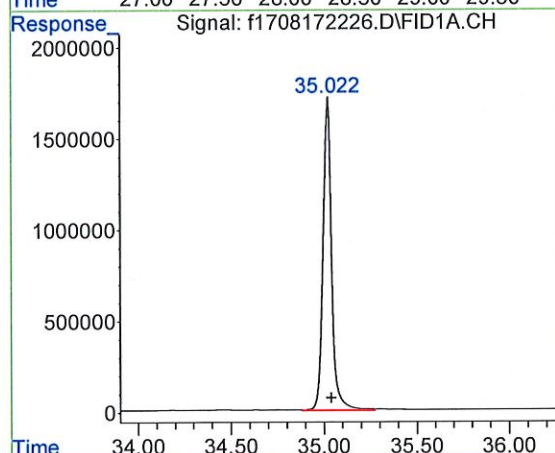

#3 d50-Tetracosane  
 R.T.: 35.022 min  
 Delta R.T.: -0.017 min  
 Response: 55360507  
 Conc: 50.51 ug/mL m

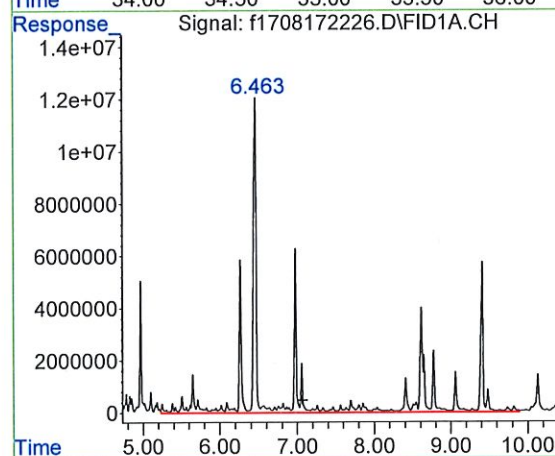

#4 > C8 to C10 Aliphatics  
 R.T.: 7.072 min  
 Delta R.T.: 0.000 min  
 Response: 1149074725  
 Conc: 919.82 ug/mL m

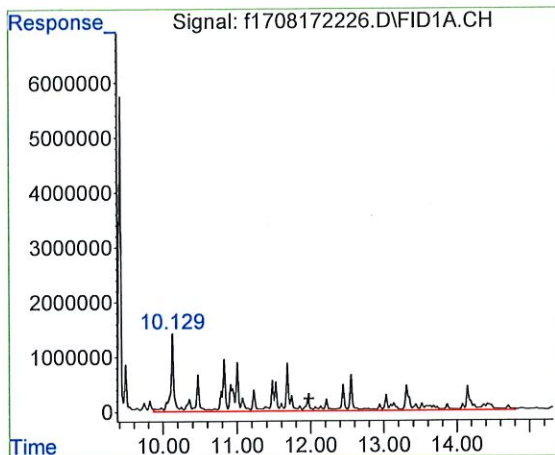

#5 > C10 to C12 Aliphatics

R.T.: 11.977 min  
 Delta R.T.: 0.000 min  
 Response: 335489692  
 Conc: 268.56 ug/ml m

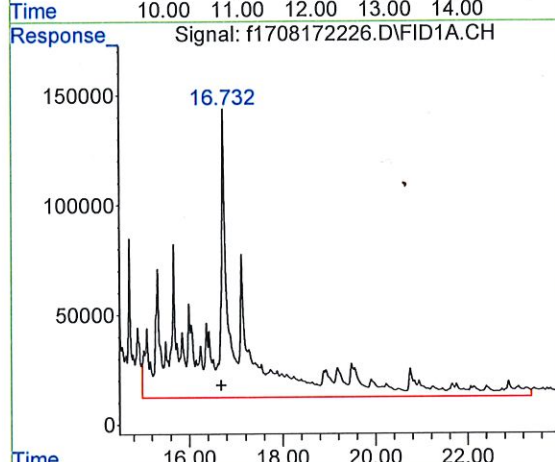

#6 > C12 to C16 Aliphatics

R.T.: 16.687 min  
 Delta R.T.: 0.000 min  
 Response: 58193772  
 Conc: 46.58 UG/ML m

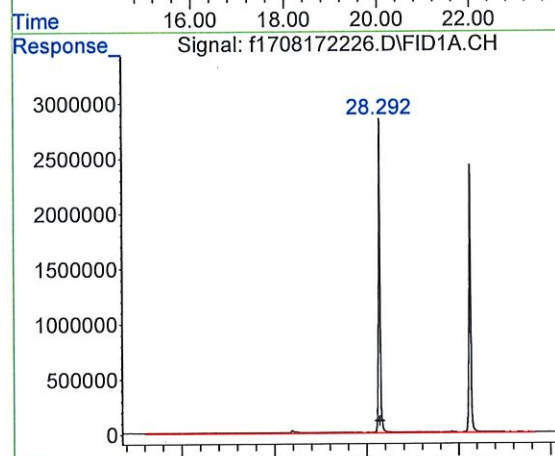

#7 > C16 to C21 Aliphatics

R.T.: 28.293 min  
 Delta R.T.: 0.000 min  
 Response: 14679873  
 Conc: 11.75 UG/ML m

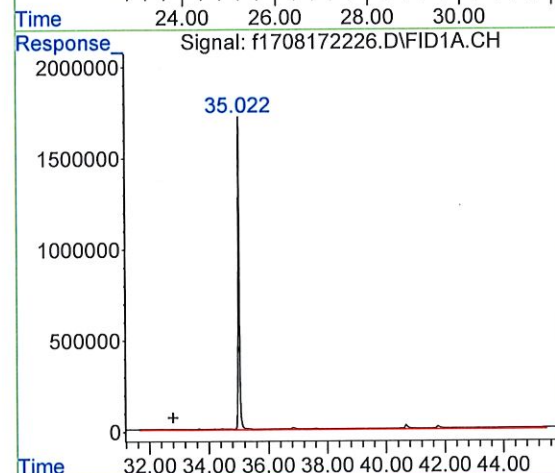

#8 > C21 to C32 Aliphatics

R.T.: 32.798 min  
 Delta R.T.: 0.000 min  
 Response: 27942125  
 Conc: 22.37 UG/ML m

Quantitation Report (QT Reviewed)

Data Path : C:\Projects\Hawaii DOH\2. Laboratory Data\Alpha\Carbon Range Study\L2240634\TPH\NF TPH\  
 Data File : f1708172228.D  
 Signal(s) : FID1A.CH  
 Acq On : 18 Aug 2022 7:40 am  
 Operator : FID17:WR  
 Sample : L2240634-10,42,,  
 Misc : WG1676467,WG1676301,ICAL18753  
 ALS Vial : 14 Sample Multiplier: 1

Integration File: autoint1.e  
 Quant Time: Oct 23 17:52:47 2022  
 Quant Method : C:\Projects\Hawaii DOH\2. Laboratory Data\Alpha\Carbon Range Study\L2240634\TPH\NF TPH\NF TPH  
 Quant Title : FID Forensics  
 QLast Update : Fri Sep 23 15:53:13 2022  
 Response via : Initial Calibration  
 Integrator: ChemStation 6890 Scale Mode: Large solvent peaks clipped

Volume Inj. :  
 Signal Phase :  
 Signal Info :

Compound	R.T.	Response	Conc Units
<b>Internal Standards</b>			
1) l 5-alpha-androstane	30.278	62079088	50.000 ug/mLm
<b>System Monitoring Compounds</b>			
2) s ortho-terphenyl	28.300	65512801	50.480 ug/mLm
Spiked Amount	50.000	Range 50 - 130	Recovery = 100.96%
3) s d50-Tetracosane	35.022	50542749	49.255 ug/mLm
Spiked Amount	50.000	Range 50 - 130	Recovery = 98.51%
<b>Target Compounds</b>			
4) h > C8 to C10 Aliphatics	7.072	328285868	280.685 ug/mLm
5) h > C10 to C12 Aliphatics	11.977	997894203	853.202 ug/mlm
6) h > C12 to C16 Aliphatics	16.687	2348760899	2008.197 UG/MLm
7) h > C16 to C21 Aliphatics	28.293	1732349970	1481.164 UG/MLm
8) h > C21 to C32 Aliphatics	32.798	394378981	337.195 UG/MLm

SemiQuant Compounds - Not Calibrated on this Instrument

(f)=RT Delta > 1/2 Window (m)=manual int.



Quantitation Report (QT Reviewed)

Data Path : C:\Projects\Hawaii DOH\2. Laboratory Data\Alpha\Carbon Range Study\L2240634\TPH\NF TPH\  
Data File : f1708172228.D  
Signal(s) : FID1A.CH  
Acq On : 18 Aug 2022 7:40 am  
Operator : FID17:WR  
Sample : L2240634-10,42,,  
Misc : WG1676467,WG1676301,ICAL18753  
ALS Vial : 14 Sample Multiplier: 1

Integration File: autoint1.e  
Quant Time: Oct 23 17:52:47 2022  
Quant Method : C:\Projects\Hawaii DOH\2. Laboratory Data\Alpha\Carbon Range Study\L2240634\TPH\NF TPH\NF TPH  
Quant Title : FID Forensics  
QLast Update : Fri Sep 23 15:53:13 2022  
Response via : Initial Calibration  
Integrator: ChemStation 6890 Scale Mode: Large solvent peaks clipped

Volume Inj. :  
Signal Phase :  
Signal Info :

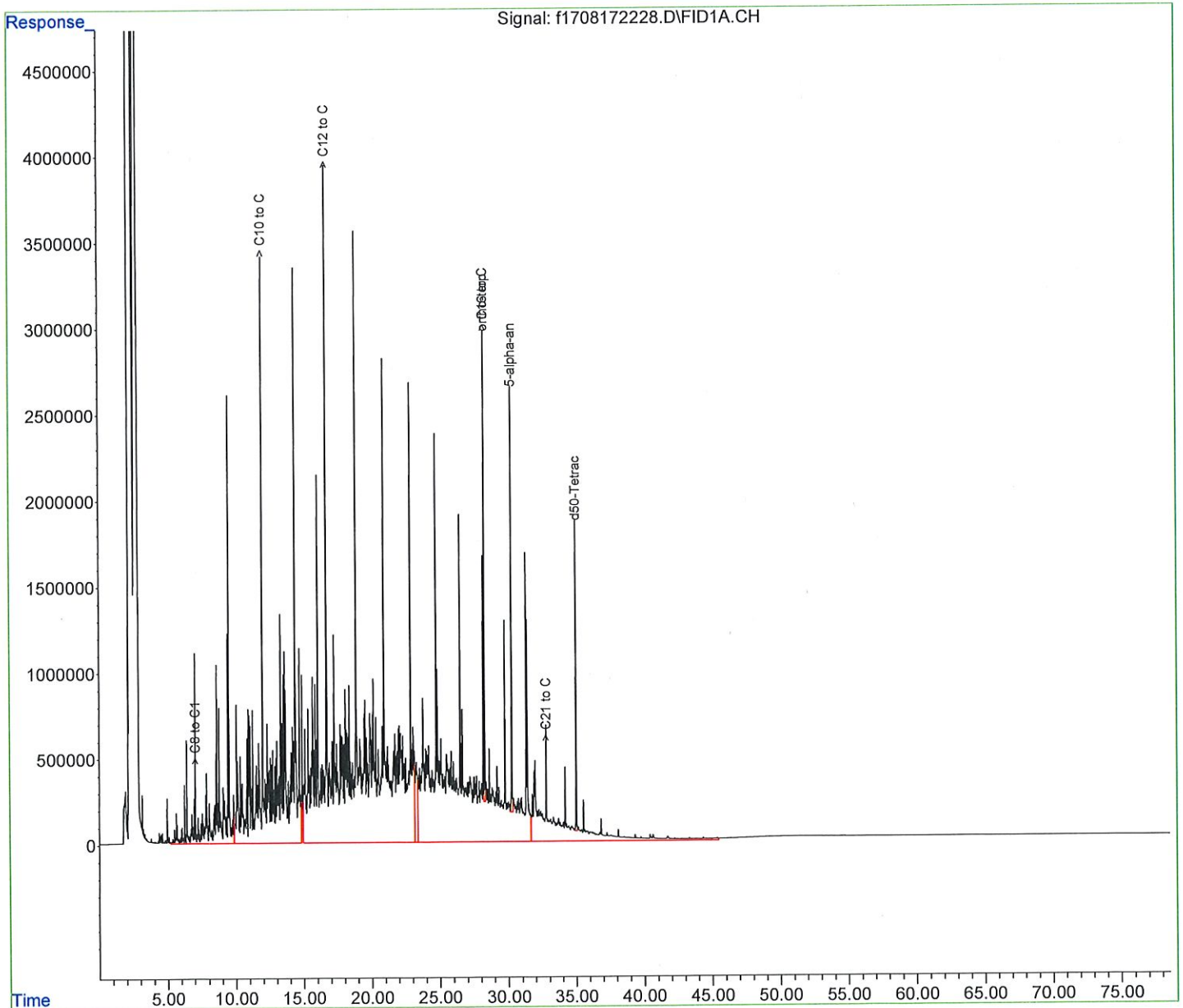

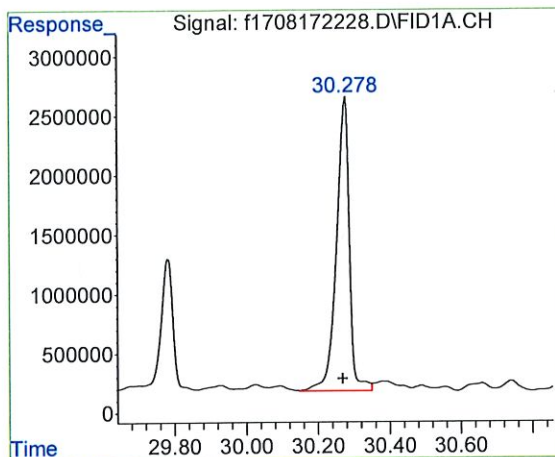

#1 5-alpha-androstane  
 R.T.: 30.278 min  
 Delta R.T.: 0.009 min  
 Response: 62079088  
 Conc: 50.00 ug/mL m

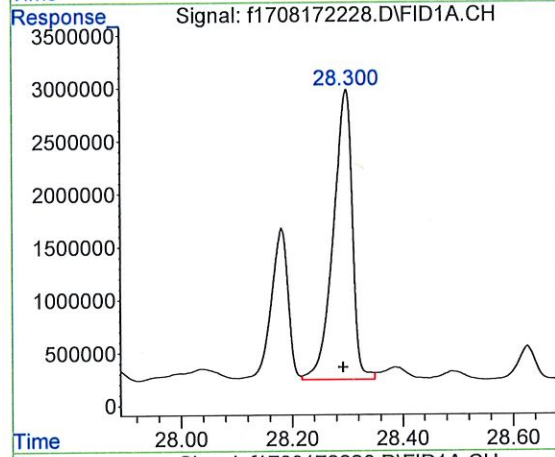

#2 ortho-terphenyl  
 R.T.: 28.300 min  
 Delta R.T.: 0.007 min  
 Response: 65512801  
 Conc: 50.48 ug/mL m

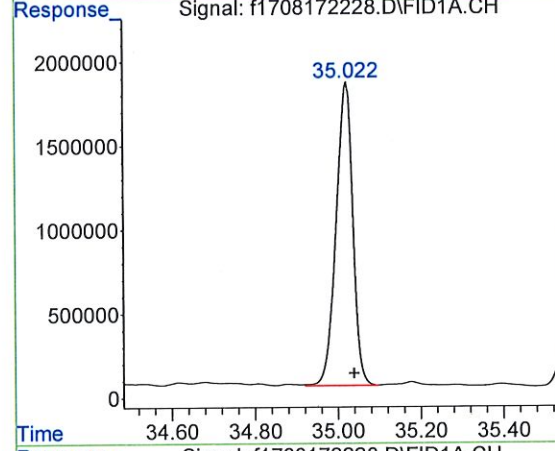

#3 d50-Tetracosane  
 R.T.: 35.022 min  
 Delta R.T.: -0.017 min  
 Response: 50542749  
 Conc: 49.25 ug/mL m

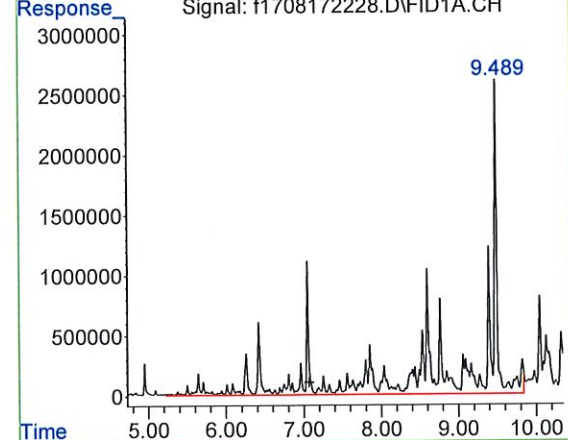

#4 > C8 to C10 Aliphatics  
 R.T.: 7.072 min  
 Delta R.T.: 0.000 min  
 Response: 328285868  
 Conc: 280.69 ug/mL m

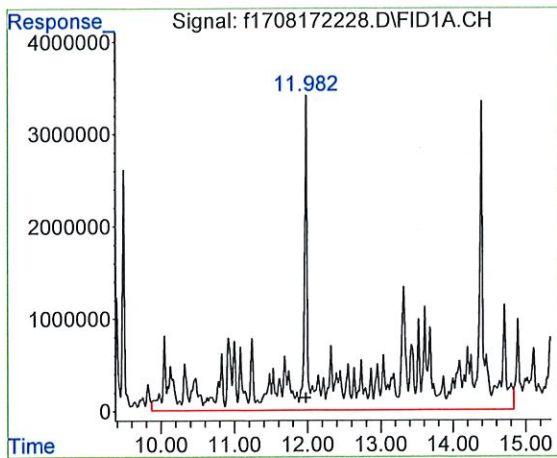

#5 > C10 to C12 Aliphatics

R.T.: 11.977 min  
 Delta R.T.: 0.000 min  
 Response: 997894203  
 Conc: 853.20 ug/ml m

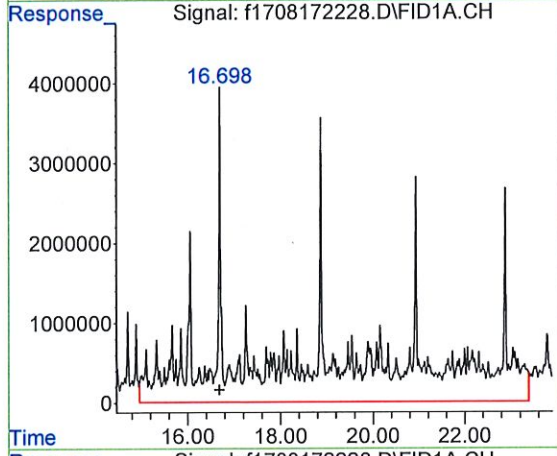

#6 > C12 to C16 Aliphatics

R.T.: 16.687 min  
 Delta R.T.: 0.000 min  
 Response: 2348760899  
 Conc: 2008.20 UG/ML m

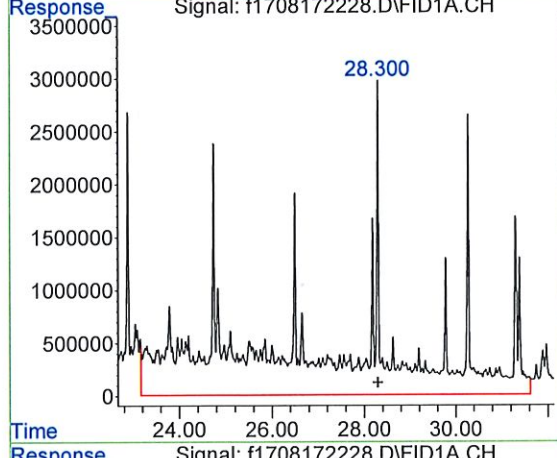

#7 > C16 to C21 Aliphatics

R.T.: 28.293 min  
 Delta R.T.: 0.000 min  
 Response: 1732349970  
 Conc: 1481.16 UG/ML m

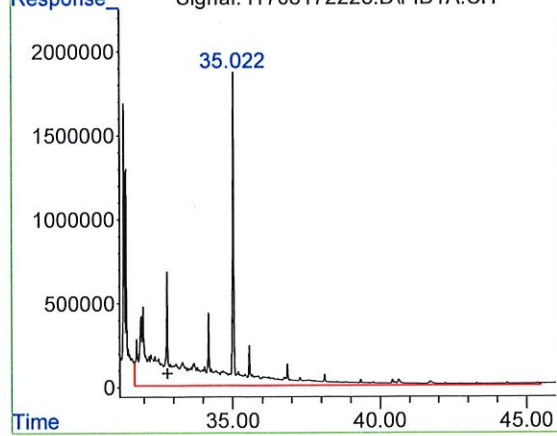

#8 > C21 to C32 Aliphatics

R.T.: 32.798 min  
 Delta R.T.: 0.000 min  
 Response: 394378981  
 Conc: 337.20 UG/ML m



Quantitation Report (QT Reviewed)

Data Path : C:\Projects\Hawaii DOH\2. Laboratory Data\Alpha\Carbon Range Study\L2240634\TPH\NF TPH\  
Data File : f1708172230.D  
Signal(s) : FID1A.CH  
Acq On : 18 Aug 2022 9:10 am  
Operator : FID17:WR  
Sample : L2240634-13,42,,  
Misc : WG1676467,WG1676301,ICAL18753  
ALS Vial : 15 Sample Multiplier: 1

Integration File: autoint1.e  
Quant Time: Oct 23 18:00:55 2022  
Quant Method : C:\Projects\Hawaii DOH\2. Laboratory Data\Alpha\Carbon Range Study\L2240634\TPH\NF TPH\NF TPH  
Quant Title : FID Forensics  
QLast Update : Fri Sep 23 15:53:13 2022  
Response via : Initial Calibration  
Integrator: ChemStation 6890 Scale Mode: Large solvent peaks clipped

Volume Inj. :  
Signal Phase :  
Signal Info :

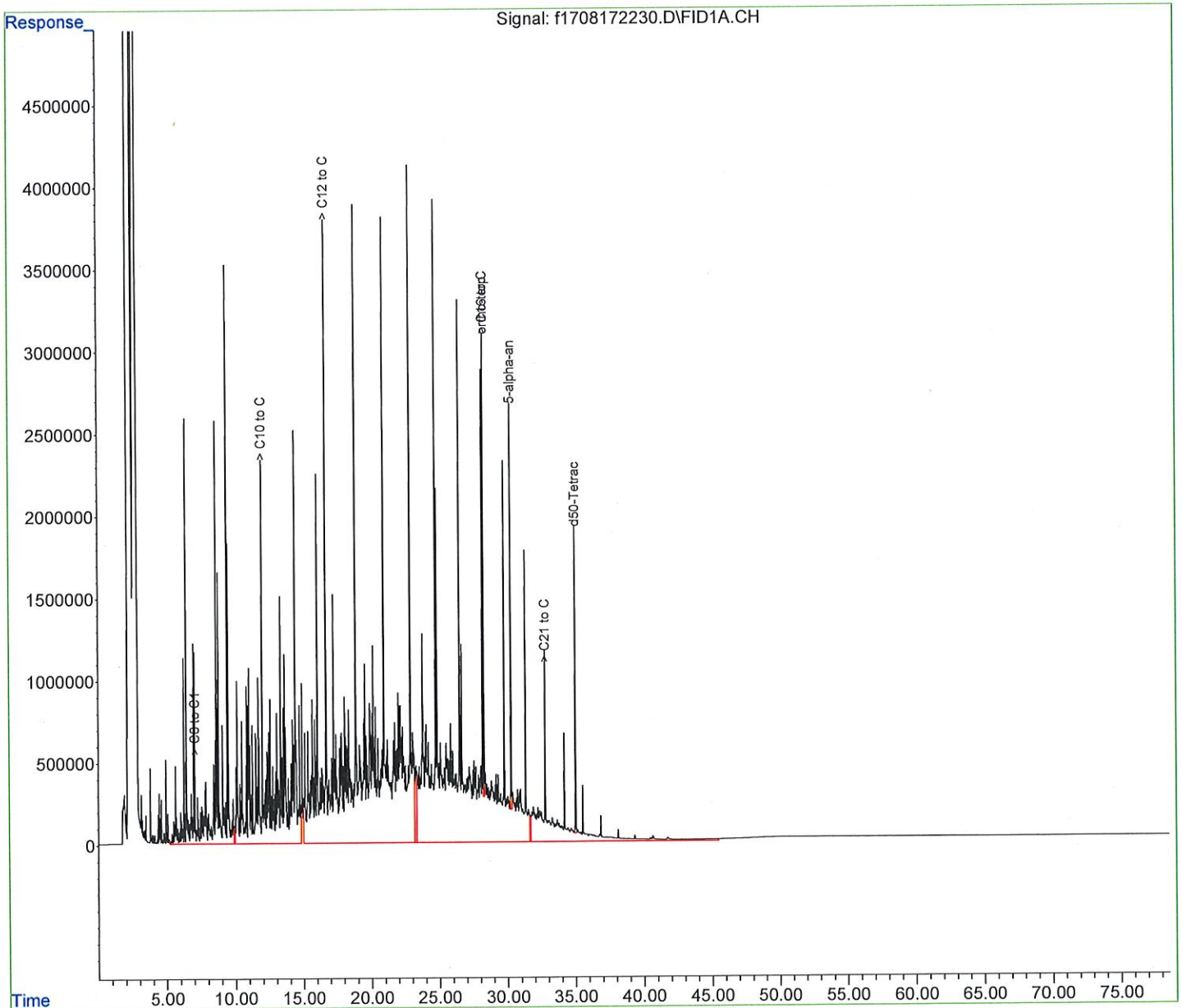

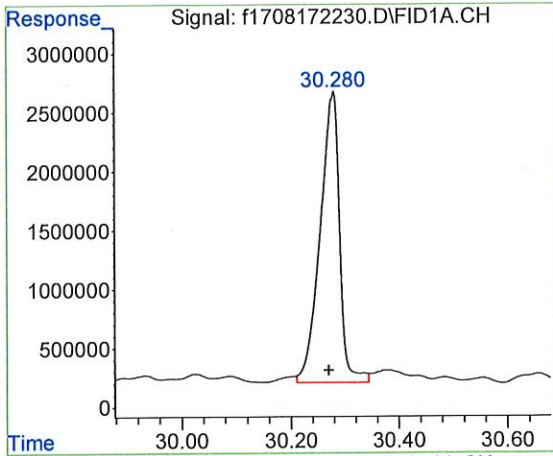

#1 5-alpha-androstane  
 R.T.: 30.280 min  
 Delta R.T.: 0.010 min  
 Response: 61549067  
 Conc: 50.00 ug/mL m

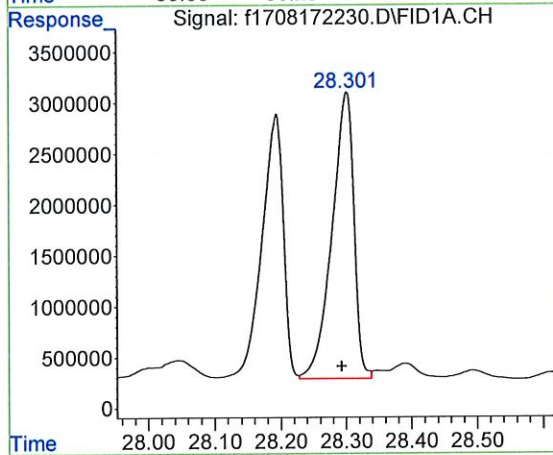

#2 ortho-terphenyl  
 R.T.: 28.301 min  
 Delta R.T.: 0.009 min  
 Response: 65613942  
 Conc: 50.99 ug/mL m

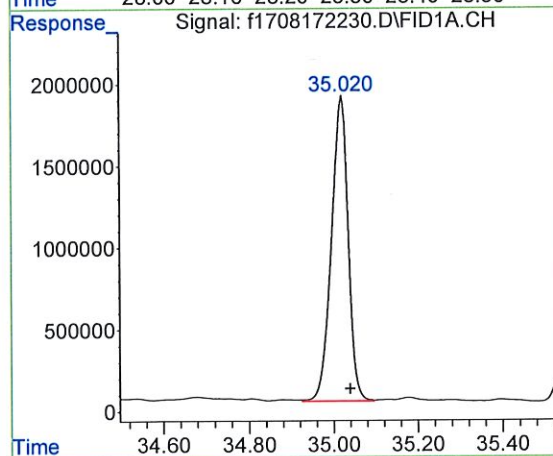

#3 d50-Tetracosane  
 R.T.: 35.020 min  
 Delta R.T.: -0.019 min  
 Response: 51390182  
 Conc: 50.51 ug/mL m

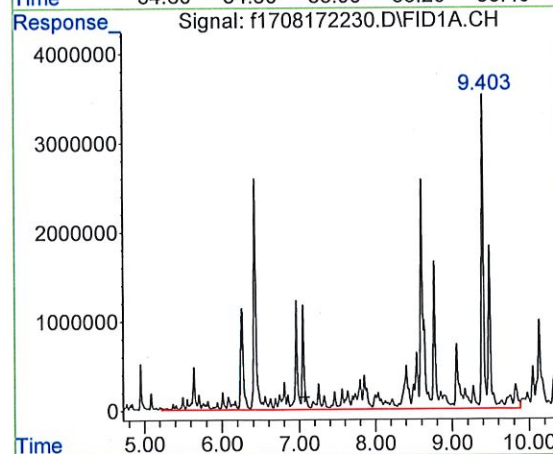

#4 > C8 to C10 Aliphatics  
 R.T.: 7.072 min  
 Delta R.T.: 0.000 min  
 Response: 548329739  
 Conc: 472.86 ug/mL m

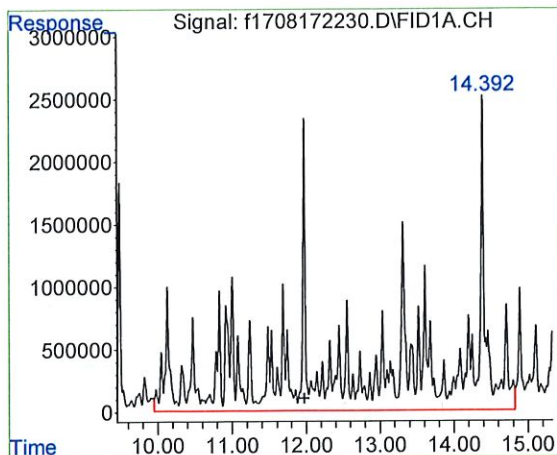

#5 > C10 to C12 Aliphatics

R.T.: 11.977 min  
 Delta R.T.: 0.000 min  
 Response: 891993370  
 Conc: 769.22 ug/ml m

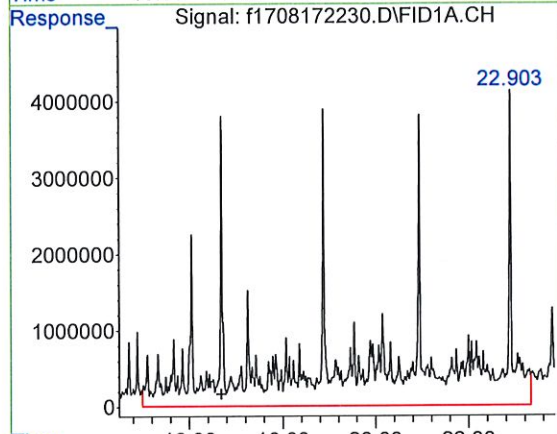

#6 > C12 to C16 Aliphatics

R.T.: 16.687 min  
 Delta R.T.: 0.000 min  
 Response: 2359478728  
 Conc: 2034.73 UG/ML m

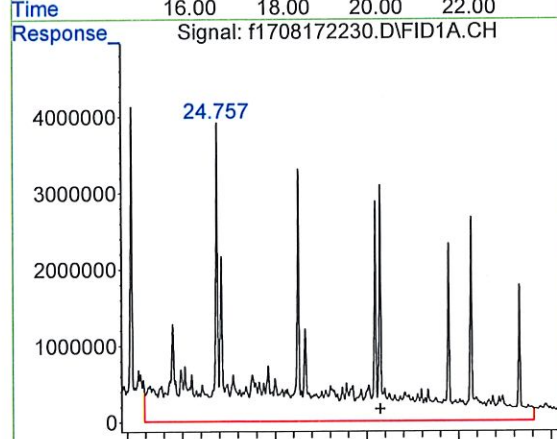

#7 > C16 to C21 Aliphatics

R.T.: 28.293 min  
 Delta R.T.: 0.000 min  
 Response: 2060299682  
 Conc: 1776.73 UG/ML m

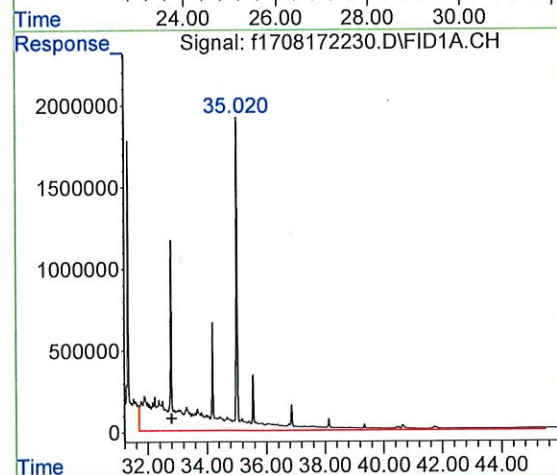

#8 > C21 to C32 Aliphatics

R.T.: 32.798 min  
 Delta R.T.: 0.000 min  
 Response: 364368418  
 Conc: 314.22 UG/ML m

Quantitation Report (QT Reviewed)

Data Path : C:\Projects\Hawaii DOH\2. Laboratory Data\Alpha\Carbon Range Study\L2240634\TPH\NF TPH\  
 Data File : f1708172232.D  
 Signal(s) : FID1A.CH  
 Acq On : 18 Aug 2022 10:41 am  
 Operator : FID17:WR  
 Sample : L2240634-16,42,,  
 Misc : WG1676467,WG1676301,ICAL18753  
 ALS Vial : 16 Sample Multiplier: 1

Integration File: autoint1.e  
 Quant Time: Oct 23 18:23:44 2022  
 Quant Method : C:\Projects\Hawaii DOH\2. Laboratory Data\Alpha\Carbon Range Study\L2240634\TPH\NF TPH\NF TPH (   
 Quant Title : FID Forensics  
 QLast Update : Fri Sep 23 15:53:13 2022  
 Response via : Initial Calibration  
 Integrator: ChemStation 6890 Scale Mode: Large solvent peaks clipped

Volume Inj. :  
 Signal Phase :  
 Signal Info :

Compound	R.T.	Response	Conc Units
Internal Standards			
1) I 5-alpha-androstane	30.261	65118623	50.000 ug/mLm
System Monitoring Compounds			
2) s ortho-terphenyl	28.287	69523879	51.070 ug/mLm
Spiked Amount	50.000	Range 50 - 130	Recovery = 102.14%
3) s d50-Tetracosane	35.020	54760510	50.874 ug/mLm
Spiked Amount	50.000	Range 50 - 130	Recovery = 101.75%
Target Compounds			
4) h > C8 to C10 Aliphatics	7.072	654593826	533.556 ug/mLm
5) h > C10 to C12 Aliphatics	11.977	2704146725	2204.134 ug/mlm
6) h > C12 to C16 Aliphatics	16.687	2823958271	2301.792 UG/MLm
7) h > C16 to C21 Aliphatics	28.293	31709527	25.846 UG/MLm
8) h > C21 to C32 Aliphatics	32.798	28077442	22.886 UG/MLm

SemiQuant Compounds - Not Calibrated on this Instrument

(f)=RT Delta > 1/2 Window

(m)=manual int.



Quantitation Report (QT Reviewed)

Data Path : C:\Projects\Hawaii DOH\2. Laboratory Data\Alpha\Carbon Range Study\L2240634\TPH\NF TPH\  
Data File : f1708172232.D  
Signal(s) : FID1A.CH  
Acq On : 18 Aug 2022 10:41 am  
Operator : FID17:WR  
Sample : L2240634-16,42,,  
Misc : WG1676467,WG1676301,ICAL18753  
ALS Vial : 16 Sample Multiplier: 1

Integration File: autoint1.e  
Quant Time: Oct 23 18:23:44 2022  
Quant Method : C:\Projects\Hawaii DOH\2. Laboratory Data\Alpha\Carbon Range Study\L2240634\TPH\NF TPH\NF TPH  
Quant Title : FID Forensics  
QLast Update : Fri Sep 23 15:53:13 2022  
Response via : Initial Calibration  
Integrator: ChemStation 6890 Scale Mode: Large solvent peaks clipped

Volume Inj. :  
Signal Phase :  
Signal Info :

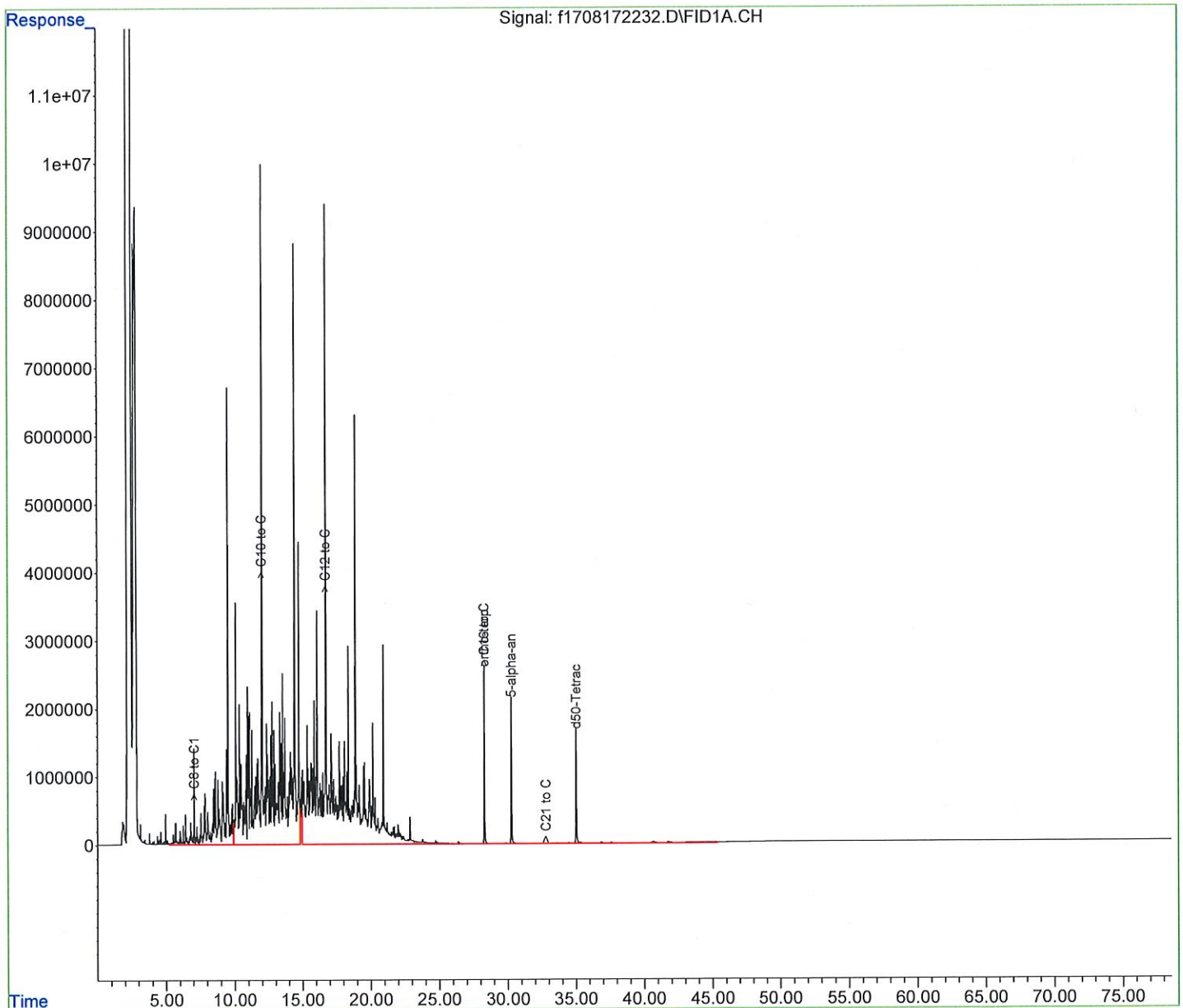

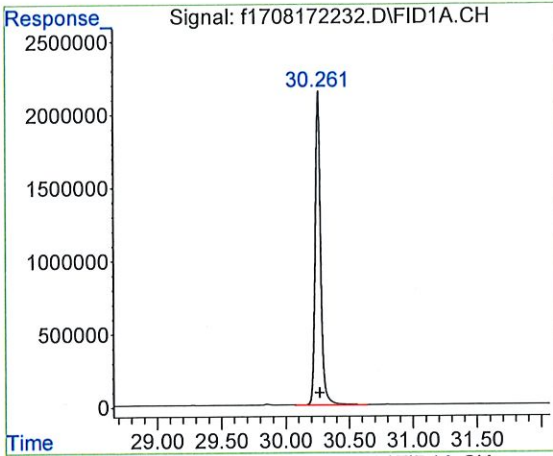

#1 5-alpha-androstane  
 R.T.: 30.261 min  
 Delta R.T.: -0.008 min  
 Response: 65118623  
 Conc: 50.00 ug/mL m

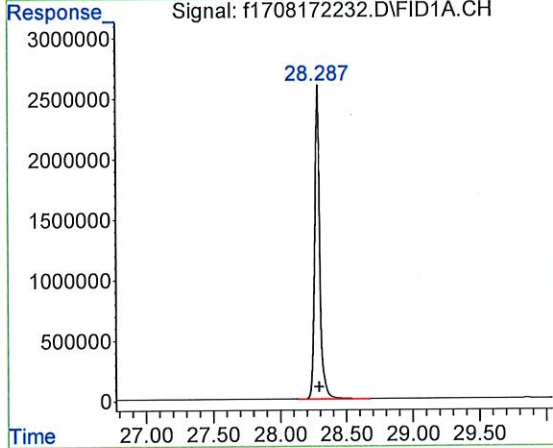

#2 ortho-terphenyl  
 R.T.: 28.287 min  
 Delta R.T.: -0.006 min  
 Response: 69523879  
 Conc: 51.07 ug/mL m

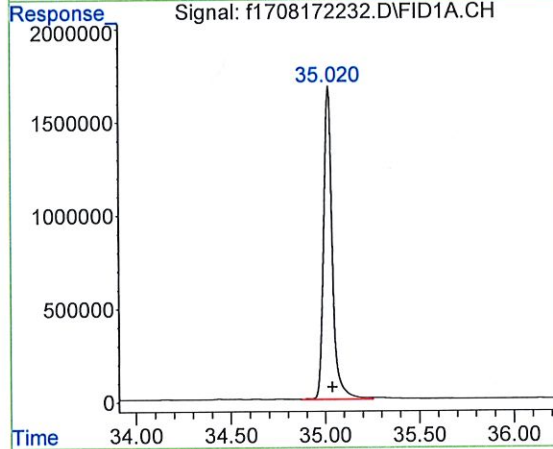

#3 d50-Tetracosane  
 R.T.: 35.020 min  
 Delta R.T.: -0.019 min  
 Response: 54760510  
 Conc: 50.87 ug/mL m

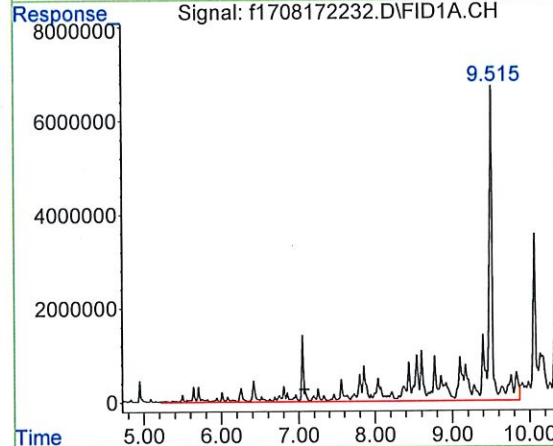

#4 > C8 to C10 Aliphatics  
 R.T.: 7.072 min  
 Delta R.T.: 0.000 min  
 Response: 654593826  
 Conc: 533.56 ug/mL m

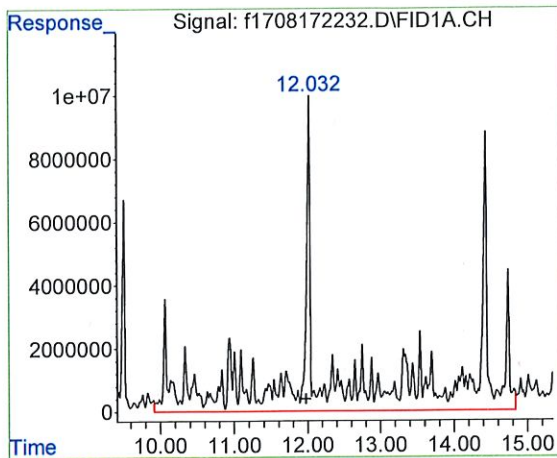

#5 > C10 to C12 Aliphatics

R.T.: 11.977 min  
 Delta R.T.: 0.000 min  
 Response: 2704146725  
 Conc: 2204.13 ug/ml m

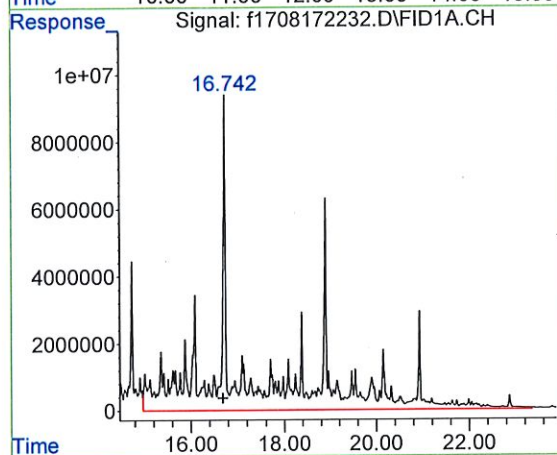

#6 > C12 to C16 Aliphatics

R.T.: 16.687 min  
 Delta R.T.: 0.000 min  
 Response: 2823958271  
 Conc: 2301.79 UG/ML m

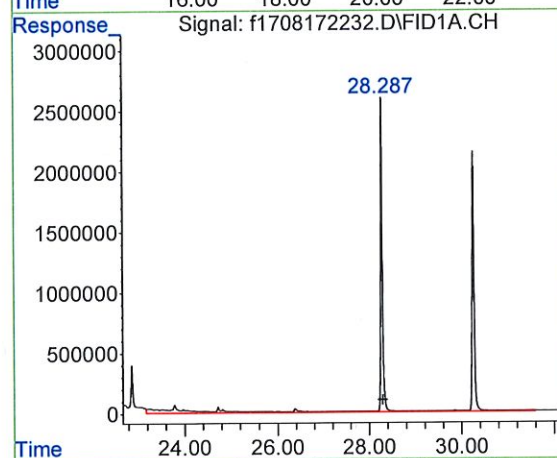

#7 > C16 to C21 Aliphatics

R.T.: 28.293 min  
 Delta R.T.: 0.000 min  
 Response: 31709527  
 Conc: 25.85 UG/ML m

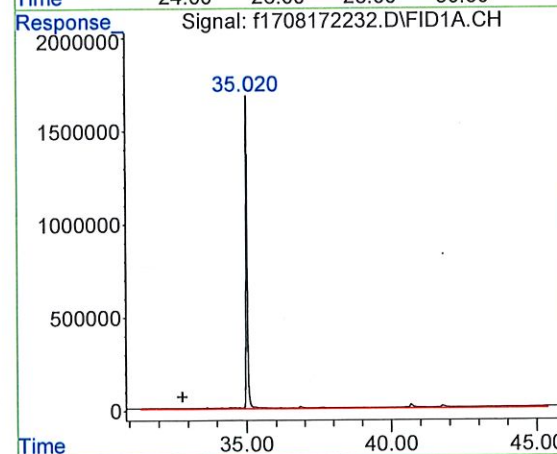

#8 > C21 to C32 Aliphatics

R.T.: 32.798 min  
 Delta R.T.: 0.000 min  
 Response: 28077442  
 Conc: 22.89 UG/ML m

Quantitation Report (QT Reviewed)

Data Path : C:\Projects\Hawaii DOH\2. Laboratory Data\Alpha\Carbon Range Study\L2240634\TPH\NF TPH\  
Data File : f1708172240.D  
Signal(s) : FID1A.CH  
Acq On : 18 Aug 2022 16:46 pm  
Operator : FID17:WR  
Sample : L2240634-19,42,,  
Misc : WG1676467,WG1676301,ICAL18753  
ALS Vial : 20 Sample Multiplier: 1

Integration File: autoint1.e  
Quant Time: Oct 23 18:38:30 2022  
Quant Method : C:\Projects\Hawaii DOH\2. Laboratory Data\Alpha\Carbon Range Study\L2240634\TPH\NF TPH\NF TPH  
Quant Title : FID Forensics  
QLast Update : Fri Sep 23 15:53:13 2022  
Response via : Initial Calibration  
Integrator: ChemStation 6890 Scale Mode: Large solvent peaks clipped

Volume Inj. :  
Signal Phase :  
Signal Info :

Compound	R.T.	Response	Conc Units
-----			
Internal Standards			
1) I 5-alpha-androstane	30.261	69177027	50.000 ug/mLm

System Monitoring Compounds			
2) s ortho-terphenyl	28.289	73601155	50.893 ug/mLm
Spiked Amount	50.000	Range 50 - 130	Recovery = 101.79%
3) s d50-Tetracosane	35.017	56914459	49.773 ug/mLm
Spiked Amount	50.000	Range 50 - 130	Recovery = 99.55%

Target Compounds			
4) h > C8 to C10 Aliphatics	7.072	1860931675	1427.846 ug/mLm
5) h > C10 to C12 Aliphatics	11.977	1926067589	1477.823 ug/mlm
6) h > C12 to C16 Aliphatics	16.687	2376840066	1823.690 UG/MLm
7) h > C16 to C21 Aliphatics	28.293	194138497	148.958 UG/MLm
8) h > C21 to C32 Aliphatics	32.798	24985414	19.171 UG/MLm

SemiQuant Compounds - Not Calibrated on this Instrument

-----  
(f)=RT Delta > 1/2 Window (m)=manual int.

Quantitation Report (QT Reviewed)

Data Path : C:\Projects\Hawaii DOH\2. Laboratory Data\Alpha\Carbon Range Study\L2240634\TPH\NF TPH\  
Data File : f1708172240.D  
Signal(s) : FID1A.CH  
Acq On : 18 Aug 2022 16:46 pm  
Operator : FID17:WR  
Sample : L2240634-19.42,,  
Misc : WG1676467,WG1676301,ICAL18753  
ALS Vial : 20 Sample Multiplier: 1

Integration File: autoint1.e  
Quant Time: Oct 23 18:38:30 2022  
Quant Method : C:\Projects\Hawaii DOH\2. Laboratory Data\Alpha\Carbon Range Study\L2240634\TPH\NF TPH\NF TPH  
Quant Title : FID Forensics  
QLast Update : Fri Sep 23 15:53:13 2022  
Response via : Initial Calibration  
Integrator: ChemStation 6890 Scale Mode: Large solvent peaks clipped

Volume Inj. :  
Signal Phase :  
Signal Info :

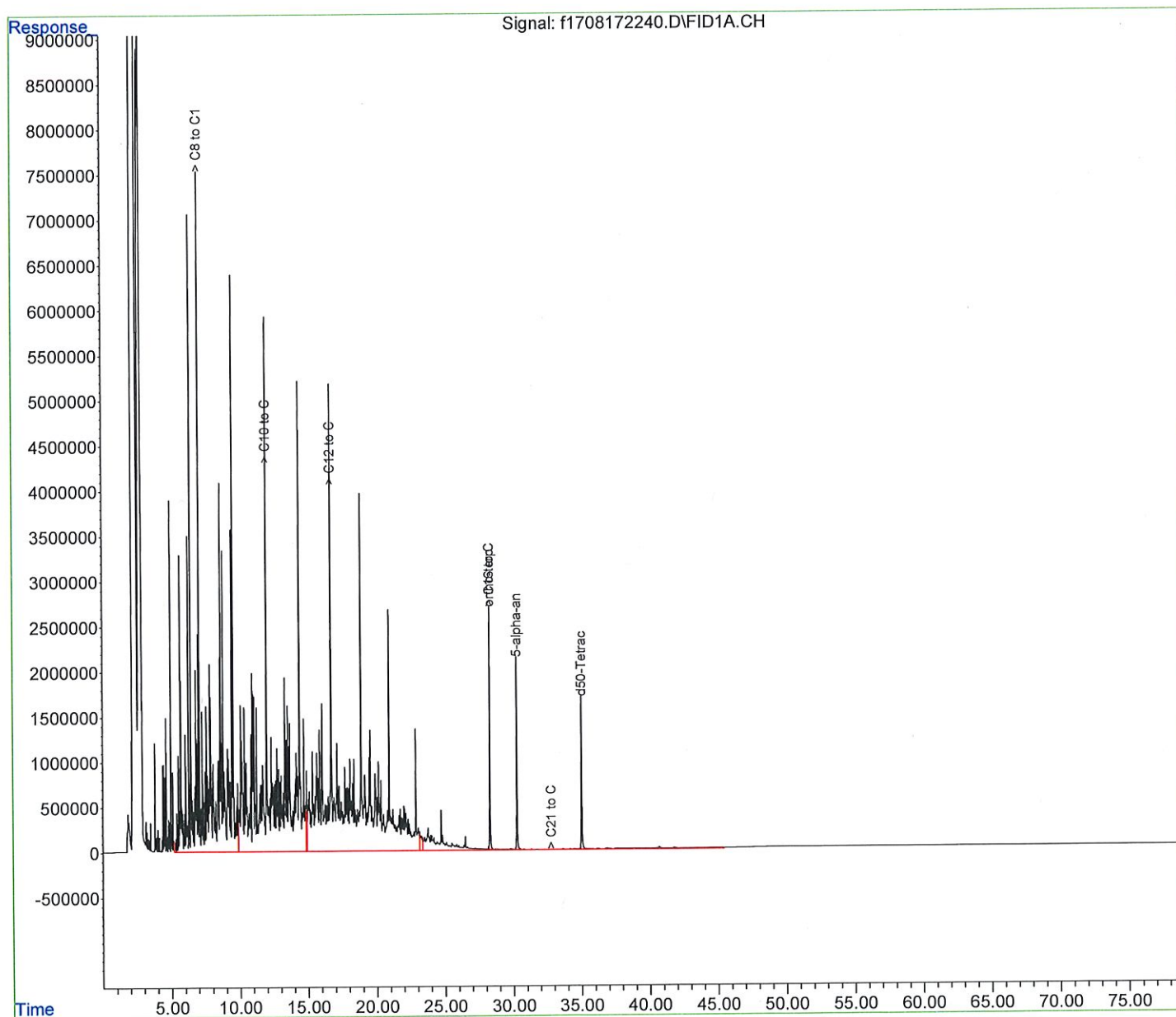

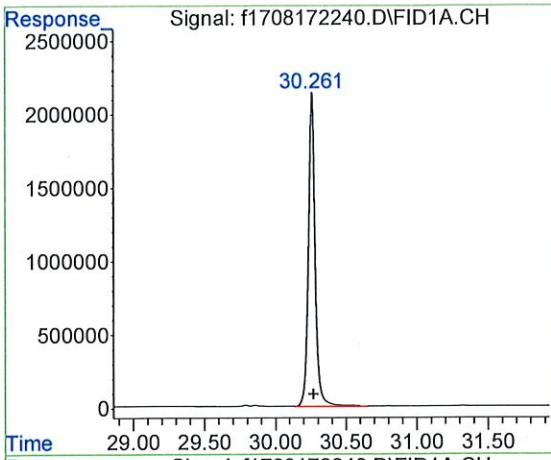

#1 5-alpha-androstane  
 R.T.: 30.261 min  
 Delta R.T.: -0.008 min  
 Response: 69177027  
 Conc: 50.00 ug/mL m

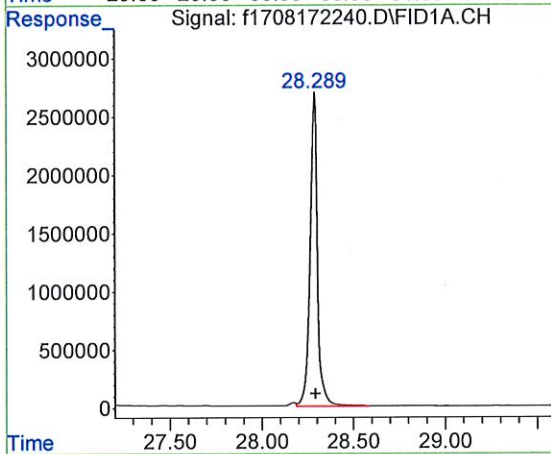

#2 ortho-terphenyl  
 R.T.: 28.289 min  
 Delta R.T.: -0.003 min  
 Response: 73601155  
 Conc: 50.89 ug/mL m

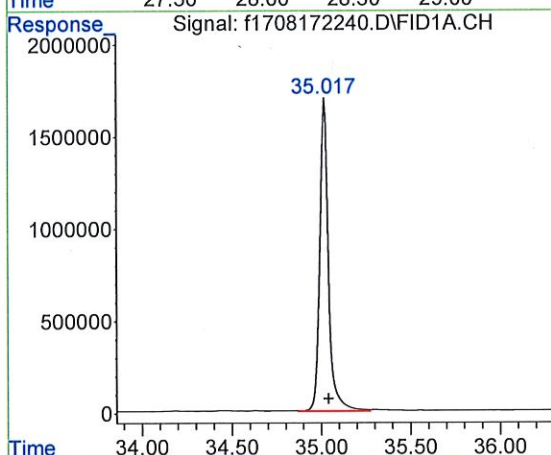

#3 d50-Tetracosane  
 R.T.: 35.017 min  
 Delta R.T.: -0.022 min  
 Response: 56914459  
 Conc: 49.77 ug/mL m

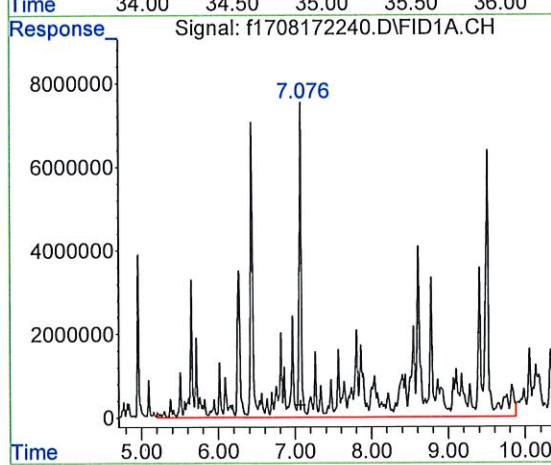

#4 > C8 to C10 Aliphatics  
 R.T.: 7.072 min  
 Delta R.T.: 0.000 min  
 Response: 1860931675  
 Conc: 1427.85 ug/mL m

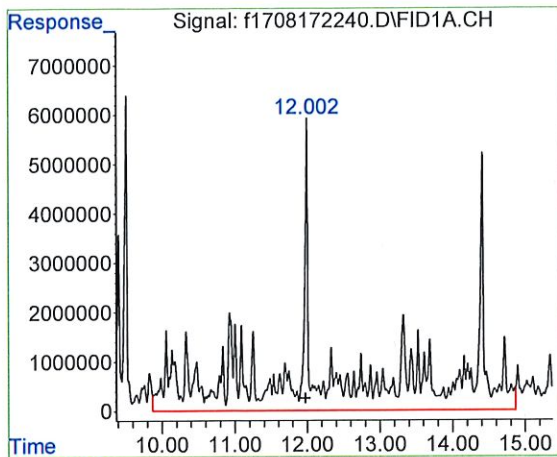

#5 > C10 to C12 Aliphatics

R.T.: 11.977 min  
 Delta R.T.: 0.000 min  
 Response: 1926067589  
 Conc: 1477.82 ug/ml m

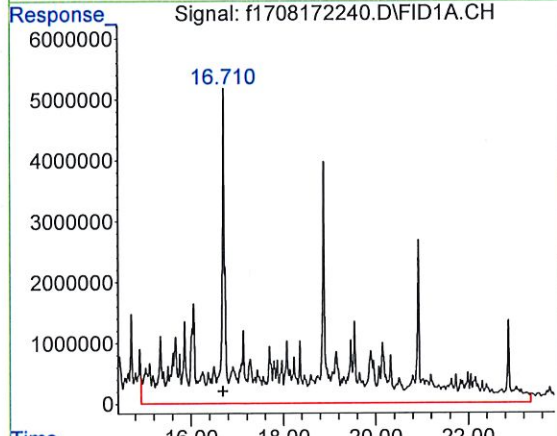

#6 > C12 to C16 Aliphatics

R.T.: 16.687 min  
 Delta R.T.: 0.000 min  
 Response: 2376840066  
 Conc: 1823.69 UG/ML m

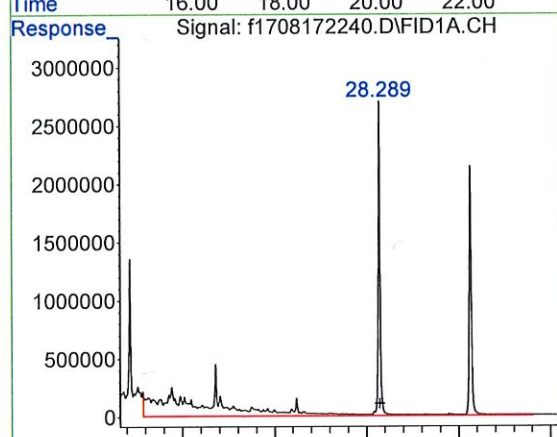

#7 > C16 to C21 Aliphatics

R.T.: 28.293 min  
 Delta R.T.: 0.000 min  
 Response: 194138497  
 Conc: 148.96 UG/ML m

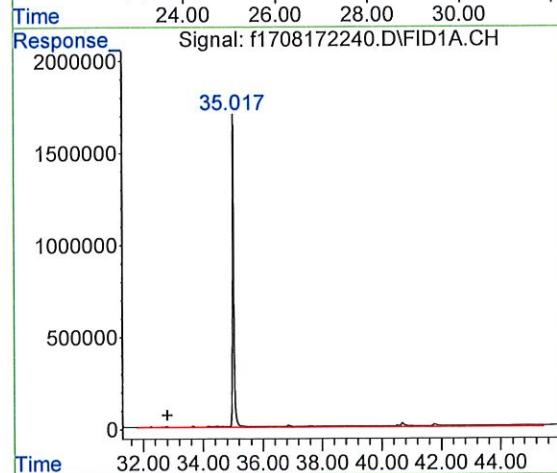

#8 > C21 to C32 Aliphatics

R.T.: 32.798 min  
 Delta R.T.: 0.000 min  
 Response: 24985414  
 Conc: 19.17 UG/ML m

Quantitation Report (QT Reviewed)

Data Path : C:\Projects\Hawaii DOH\2. Laboratory Data\Alpha\Carbon Range Study\L2240634\TPH\NF TPH\  
Data File : f1708172244.D  
Signal(s) : FID1A.CH  
Acq On : 18 Aug 2022 19:48 pm  
Operator : FID17:WR  
Sample : L2240634-25,42,,  
Misc : WG1676467,WG1676301,ICAL18753  
ALS Vial : 22 Sample Multiplier: 1

Integration File: autoint1.e  
Quant Time: Oct 23 18:47:29 2022  
Quant Method : C:\Projects\Hawaii DOH\2. Laboratory Data\Alpha\Carbon Range Study\L2240634\TPH\NF TPH\NF TPH (   
Quant Title : FID Forensics  
QLast Update : Fri Sep 23 15:53:13 2022  
Response via : Initial Calibration  
Integrator: ChemStation 6890 Scale Mode: Large solvent peaks clipped

Volume Inj. :  
Signal Phase :  
Signal Info :

Compound	R.T.	Response	Conc Units
Internal Standards			
1) I 5-alpha-androstane	30.270	69299970	50.000 ug/mLm
System Monitoring Compounds			
2) s ortho-terphenyl	28.294	73139576	50.485 ug/mLm
Spiked Amount	50.000	Range 50 - 130	Recovery = 100.97%
3) s d50-Tetracosane	35.024	60804744	53.081 ug/mLm
Spiked Amount	50.000	Range 50 - 130	Recovery = 106.16%
Target Compounds			
4) h > C8 to C10 Aliphatics	7.072	12357325	9.465 ug/mLm
5) h > C10 to C12 Aliphatics	11.977	200670480	153.696 ug/mlm
6) h > C12 to C16 Aliphatics	16.687	642632413	492.201 UG/MLm
7) h > C16 to C21 Aliphatics	28.293	752619422	576.442 UG/MLm
8) h > C21 to C32 Aliphatics	32.798	1935070135	1482.097 UG/MLm

SemiQuant Compounds - Not Calibrated on this Instrument

(f)=RT Delta > 1/2 Window (m)=manual int.



File :C:\Projects\Hawaii DOH\2. Laboratory Data\Alpha\Carbon Range  
... Study\L2240634\TPH\NF TPH\1708172244.D  
Operator : FID17:WR  
Instrument : FID17  
Acquired : 18 Aug 2022 19:48 pm using AcqMethod FID17A.M  
Sample Name: L2240634-25,42,,  
Misc Info : WG1676467,WG1676301,ICAL18753

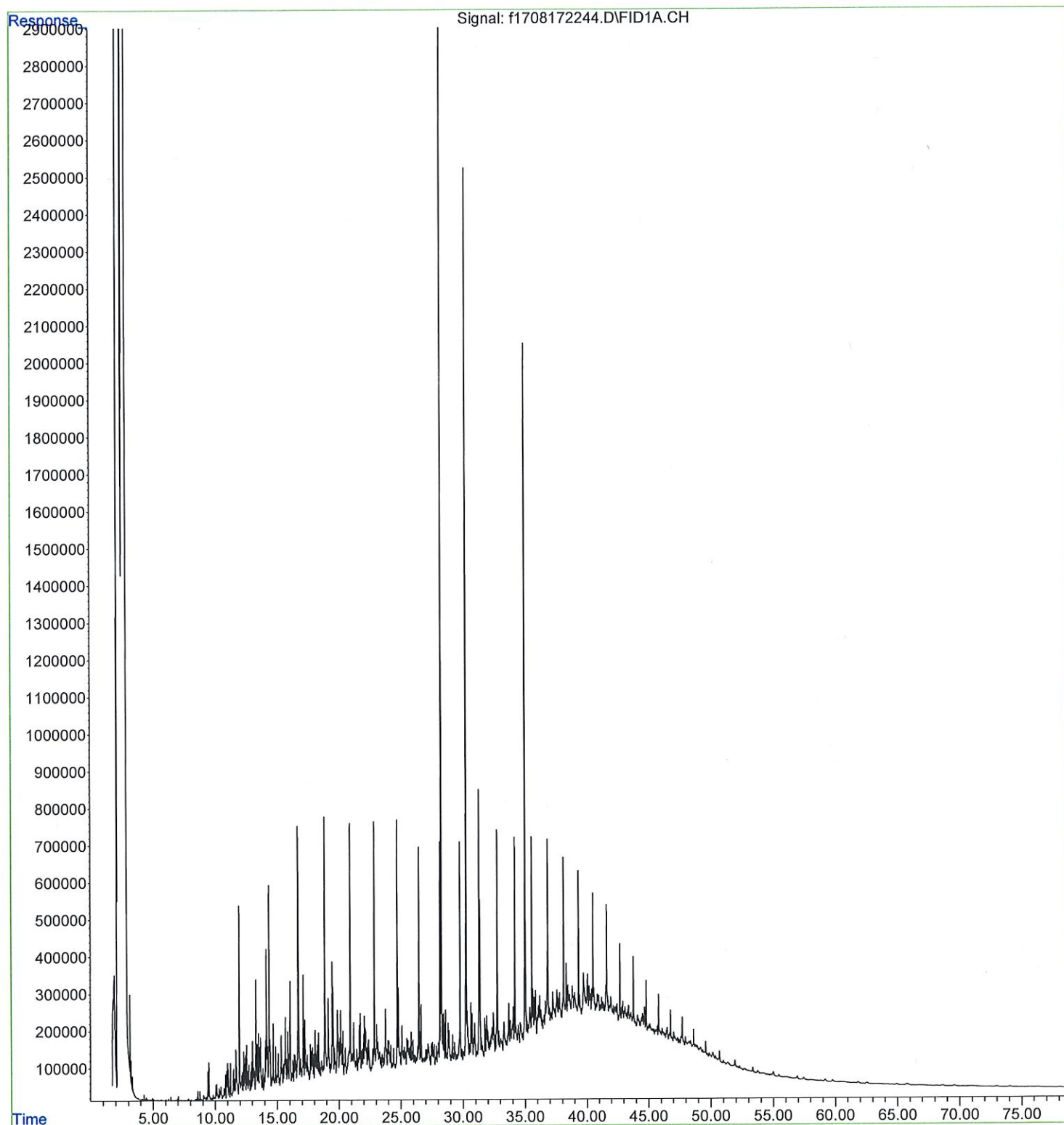

Quantitation Report (QT Reviewed)

Data Path : C:\Projects\Hawaii DOH\2. Laboratory Data\Alpha\Carbon Range Study\L2240634\TPH\NF TPH\  
Data File : f1708172244.D  
Signal(s) : FID1A.CH  
Acq On : 18 Aug 2022 19:48 pm  
Operator : FID17:WR  
Sample : L2240634-25,42,,  
Misc : WG1676467,WG1676301,ICAL18753  
ALS Vial : 22 Sample Multiplier: 1

Integration File: autoint1.e  
Quant Time: Oct 23 18:47:29 2022  
Quant Method : C:\Projects\Hawaii DOH\2. Laboratory Data\Alpha\Carbon Range Study\L2240634\TPH\NF TPH\NF TPH  
Quant Title : FID Forensics  
QLast Update : Fri Sep 23 15:53:13 2022  
Response via : Initial Calibration  
Integrator: ChemStation 6890 Scale Mode: Large solvent peaks clipped

Volume Inj. :  
Signal Phase :  
Signal Info :

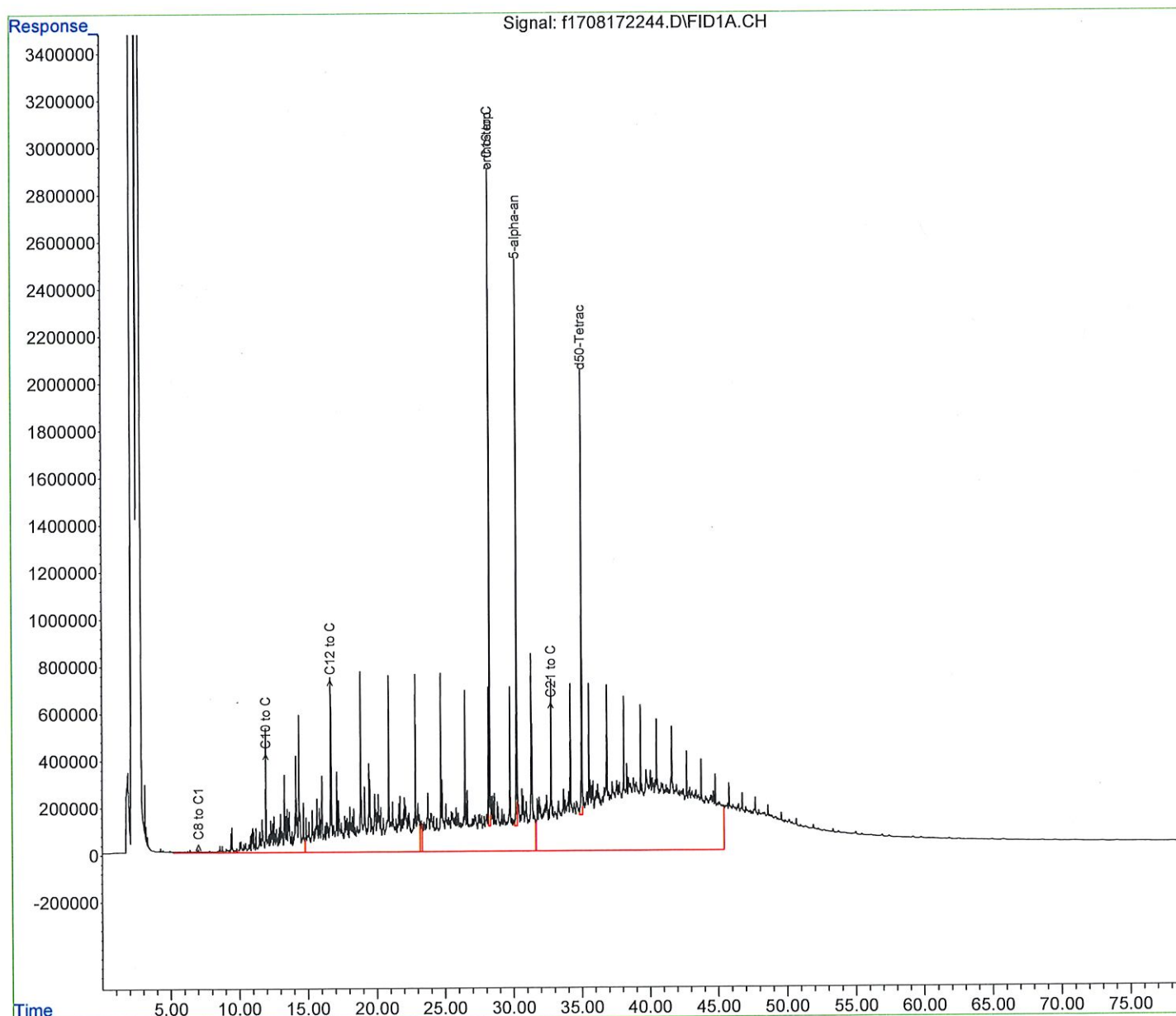

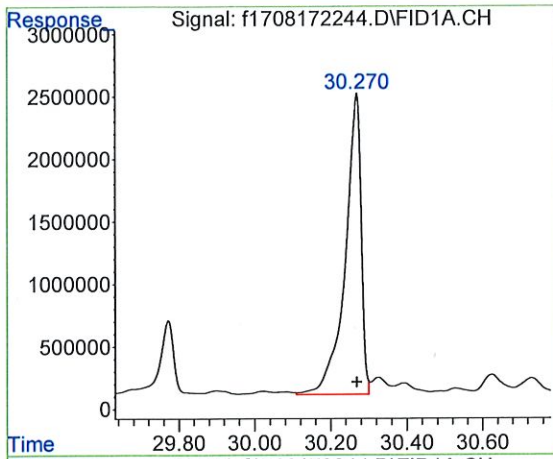

#1 5-alpha-androstane  
 R.T.: 30.270 min  
 Delta R.T.: 0.000 min  
 Response: 69299970  
 Conc: 50.00 ug/mL m

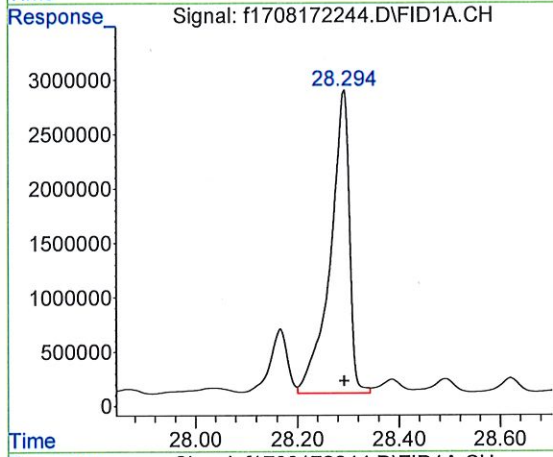

#2 ortho-terphenyl  
 R.T.: 28.294 min  
 Delta R.T.: 0.000 min  
 Response: 73139576  
 Conc: 50.48 ug/mL m

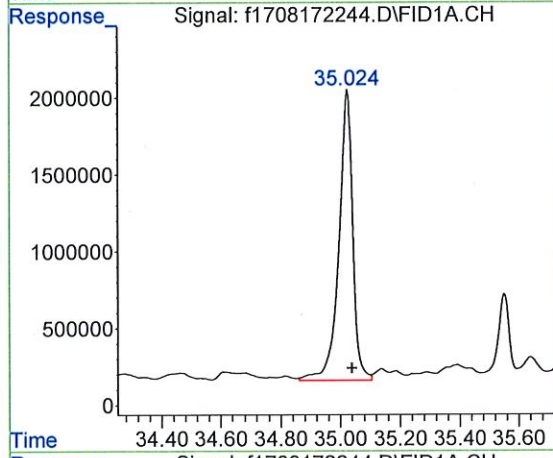

#3 d50-Tetracosane  
 R.T.: 35.024 min  
 Delta R.T.: -0.015 min  
 Response: 60804744  
 Conc: 53.08 ug/mL m

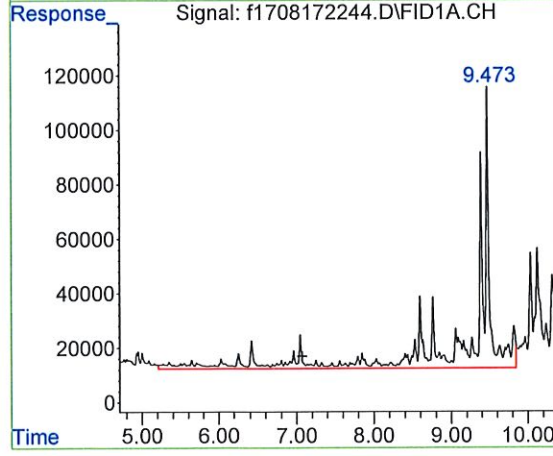

#4 > C8 to C10 Aliphatics  
 R.T.: 7.072 min  
 Delta R.T.: 0.000 min  
 Response: 12357325  
 Conc: 9.46 ug/mL m

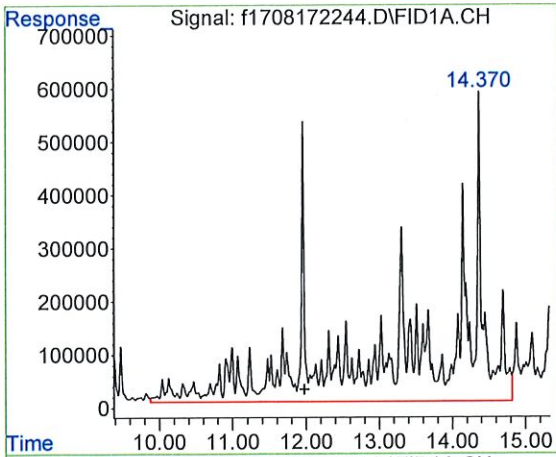

#5 > C10 to C12 Aliphatics  
 R.T.: 11.977 min  
 Delta R.T.: 0.000 min  
 Response: 200670480  
 Conc: 153.70 ug/ml m

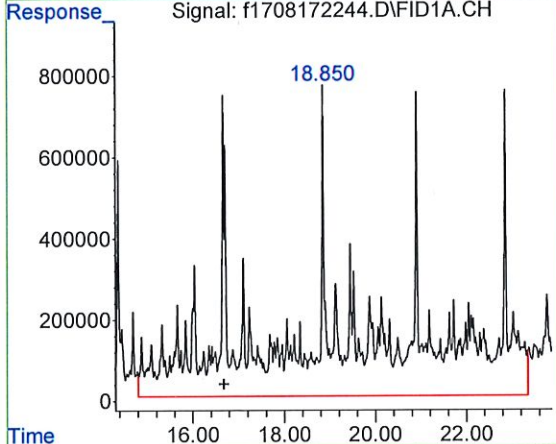

#6 > C12 to C16 Aliphatics  
 R.T.: 16.687 min  
 Delta R.T.: 0.000 min  
 Response: 642632413  
 Conc: 492.20 UG/ML m

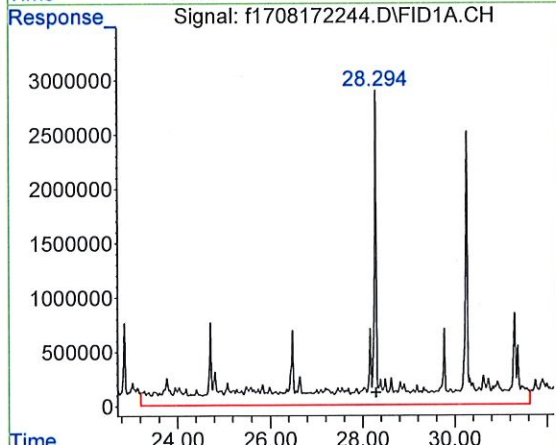

#7 > C16 to C21 Aliphatics  
 R.T.: 28.293 min  
 Delta R.T.: 0.000 min  
 Response: 752619422  
 Conc: 576.44 UG/ML m

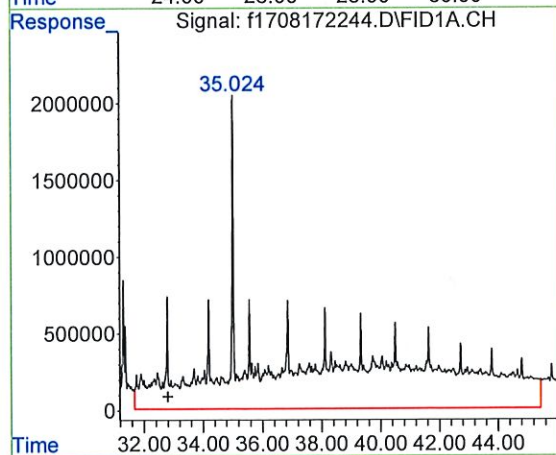

#8 > C21 to C32 Aliphatics  
 R.T.: 32.798 min  
 Delta R.T.: 0.000 min  
 Response: 1935070135  
 Conc: 1482.10 UG/ML m

Quantitation Report (QT Reviewed)

Data Path : C:\Projects\Hawaii DOH\2. Laboratory Data\Alpha\Carbon Range Study\L2240634\TPH\NF TPH\  
Data File : f1709062236.D  
Signal(s) : FID1A.CH  
Acq On : 07 Sep 2022 16:05 pm  
Operator : FID17:WR  
Sample : I2240634-32,42,,  
Misc : WG1684077,WG1682983,ICAL18753  
ALS Vial : 18 Sample Multiplier: 1

Integration File: autoint1.e  
Quant Time: Oct 23 19:21:04 2022  
Quant Method : C:\Projects\Hawaii DOH\2. Laboratory Data\Alpha\Carbon Range Study\L2240634\TPH\NF TPH\NF TPH (   
Quant Title : FID Forensics  
QLast Update : Sun Oct 23 18:48:52 2022  
Response via : Initial Calibration  
Integrator: ChemStation 6890 Scale Mode: Large solvent peaks clipped

Volume Inj. :  
Signal Phase :  
Signal Info :

Compound	R.T.	Response	Conc Units
Internal Standards			
1) I 5-alpha-androstane	30.083	74106757	50.000 ug/mLm
System Monitoring Compounds			
2) s ortho-terphenyl	28.113	70607308	45.575 ug/mLm
Spiked Amount	50.000	Range 50 - 130	Recovery = 91.15%
3) s d50-Tetracosane	34.865	57756883	47.150 ug/mLm
Spiked Amount	50.000	Range 50 - 130	Recovery = 94.30%
Target Compounds			
4) h > C8 to C10 Aliphatics	7.029	30357146	21.743 ug/mLm
5) h > C10 to C12 Aliphatics	11.903	40921226	29.309 ug/mlm
6) h > C12 to C16 Aliphatics	16.584	57780945	41.385 UG/MLm
7) h > C16 to C21 Aliphatics	28.119	119151760	85.341 UG/MLm
8) h > C21 to C32 Aliphatics	32.596	4873232031	3490.376 UG/MLm

SemiQuant Compounds - Not Calibrated on this Instrument

(f)=RT Delta > 1/2 Window

(m)=manual int.

Quantitation Report (QT Reviewed)

Data Path : C:\Projects\Hawaii DOH\2. Laboratory Data\Alpha\Carbon Range Study\L2240634\TPH\NF TPH\  
Data File : f1709062236.D  
Signal(s) : FID1A.CH  
Acq On : 07 Sep 2022 16:05 pm  
Operator : FID17:WR  
Sample : I2240634-32,42,,  
Misc : WG1684077,WG1682983,ICAL18753  
ALS Vial : 18 Sample Multiplier: 1

Integration File: autoint1.e  
Quant Time: Oct 23 19:21:04 2022  
Quant Method : C:\Projects\Hawaii DOH\2. Laboratory Data\Alpha\Carbon Range Study\L2240634\TPH\NF TPH\NF TPH  
Quant Title : FID Forensics  
QLast Update : Sun Oct 23 18:48:52 2022  
Response via : Initial Calibration  
Integrator: ChemStation 6890 Scale Mode: Large solvent peaks clipped

Volume Inj. :  
Signal Phase :  
Signal Info :

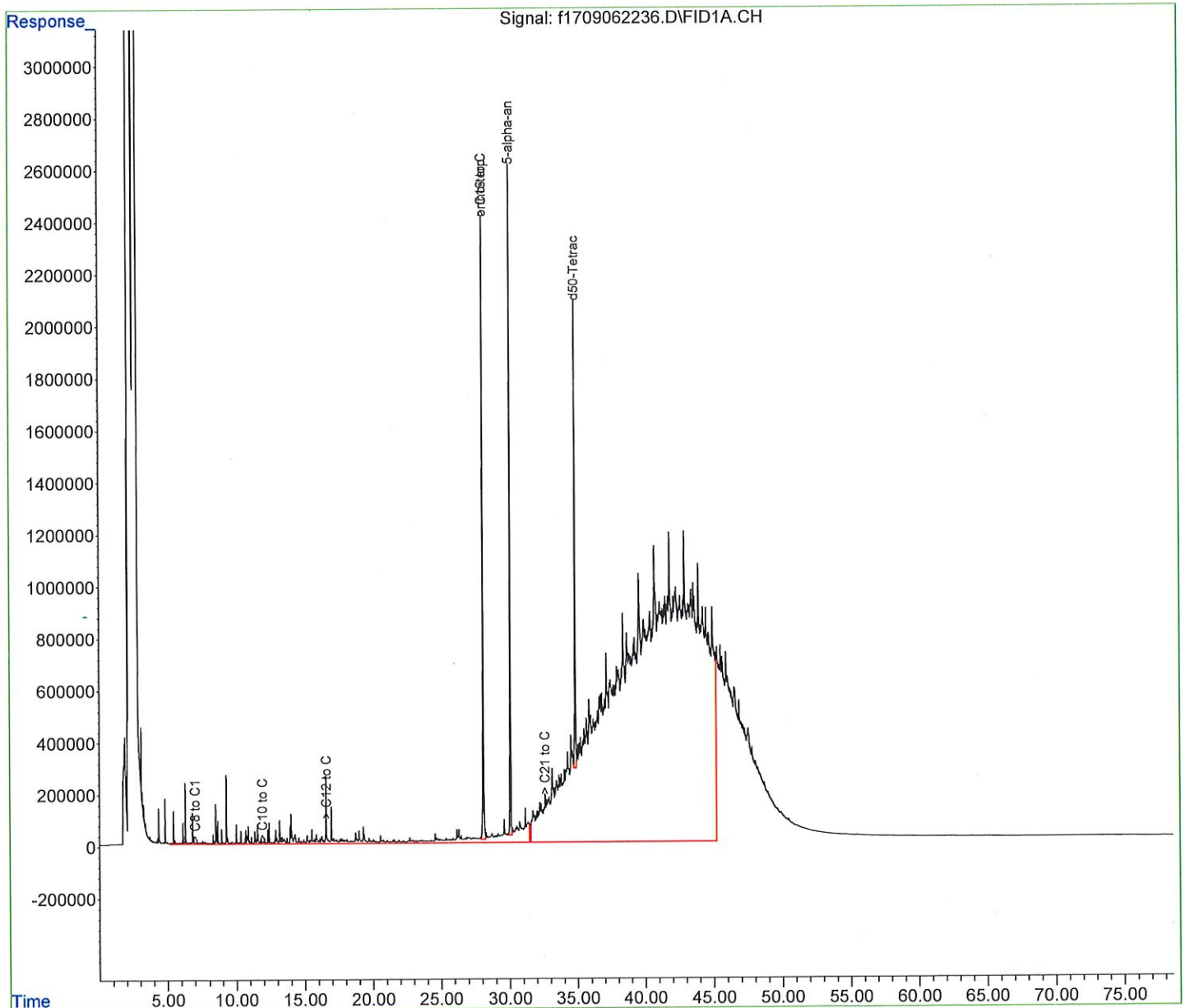

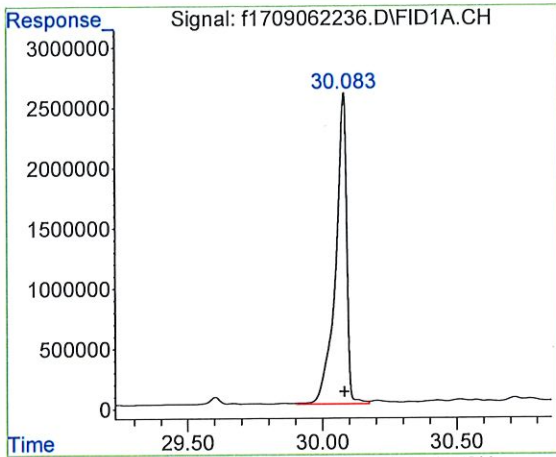

#1 5-alpha-androstane  
 R.T.: 30.083 min  
 Delta R.T.: 0.000 min  
 Response: 74106757  
 Conc: 50.00 ug/mL m

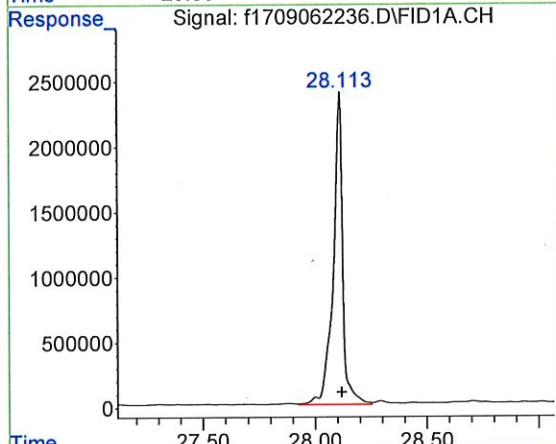

#2 ortho-terphenyl  
 R.T.: 28.113 min  
 Delta R.T.: -0.006 min  
 Response: 70607308  
 Conc: 45.58 ug/mL m

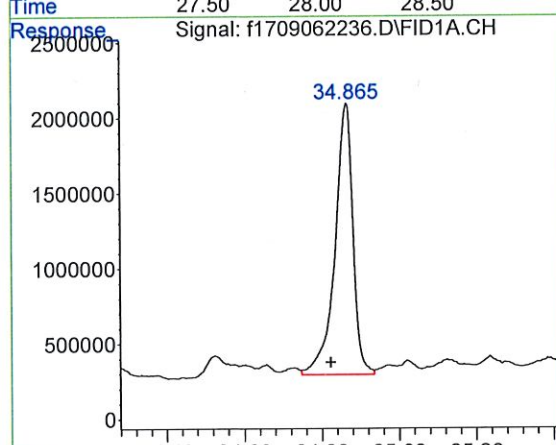

#3 d50-Tetracosane  
 R.T.: 34.865 min  
 Delta R.T.: 0.041 min  
 Response: 57756883  
 Conc: 47.15 ug/mL m

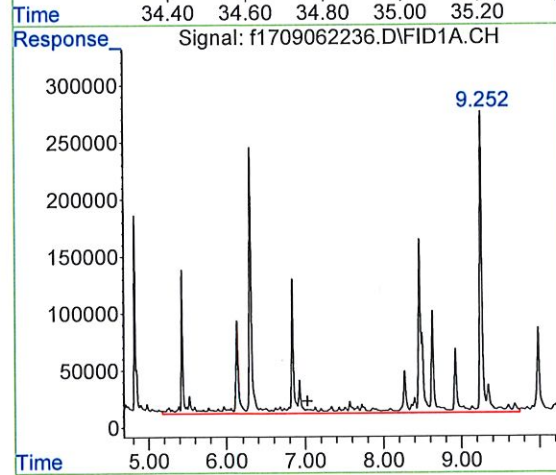

#4 > C8 to C10 Aliphatics  
 R.T.: 7.029 min  
 Delta R.T.: 0.000 min  
 Response: 30357146  
 Conc: 21.74 ug/mL m

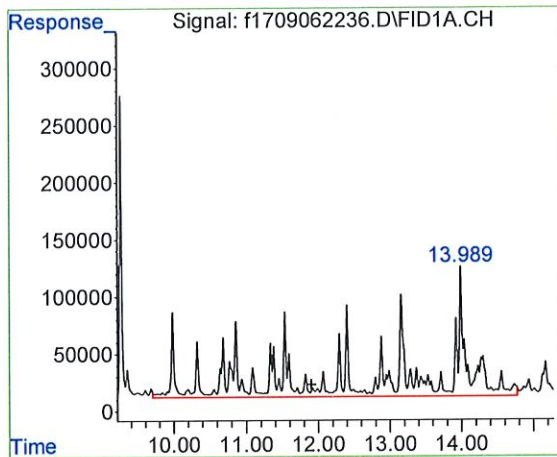

#5 > C10 to C12 Aliphatics

R.T.: 11.903 min  
 Delta R.T.: 0.000 min  
 Response: 40921226  
 Conc: 29.31 ug/ml m

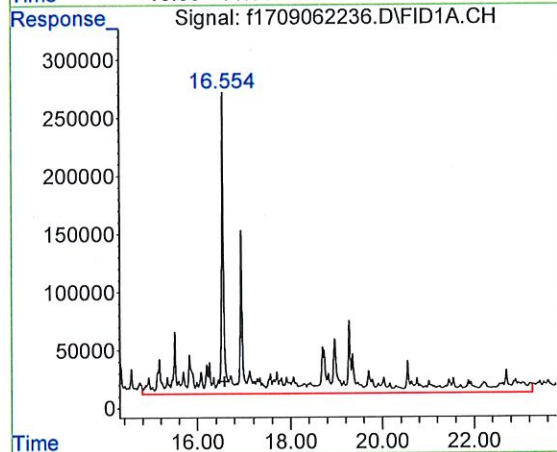

#6 > C12 to C16 Aliphatics

R.T.: 16.584 min  
 Delta R.T.: 0.000 min  
 Response: 57780945  
 Conc: 41.38 UG/ML m

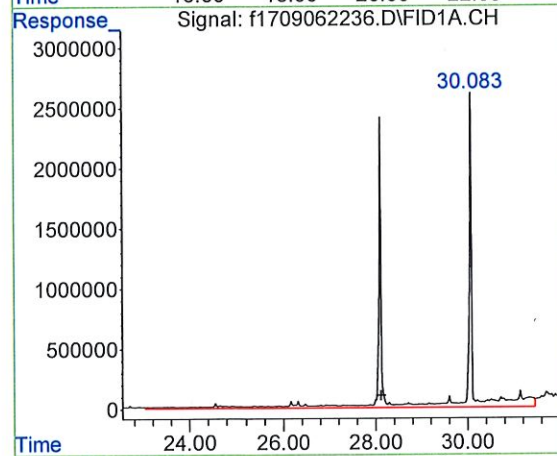

#7 > C16 to C21 Aliphatics

R.T.: 28.119 min  
 Delta R.T.: 0.000 min  
 Response: 119151760  
 Conc: 85.34 UG/ML m

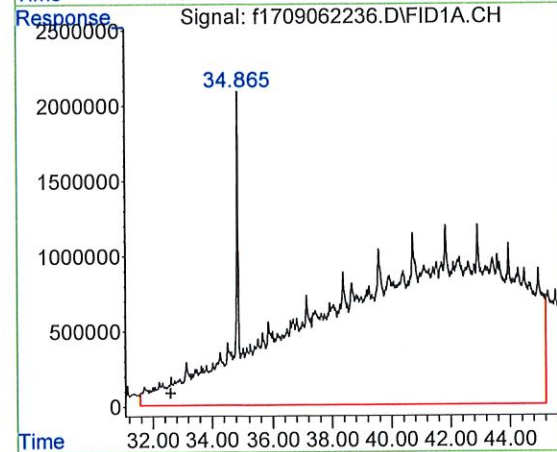

#8 > C21 to C32 Aliphatics

R.T.: 32.596 min  
 Delta R.T.: 0.000 min  
 Response: 4873232031  
 Conc: 3490.38 UG/ML m



Quantitation Report (QT Reviewed)

Data Path : C:\Projects\Hawaii DOH\2. Laboratory Data\Alpha\Carbon Range Study\L2240634\TPH\NF TPH  
Data File : f1708172252.D  
Signal(s) : FID1A.CH  
Acq On : 19 Aug 2022 1:49 am  
Operator : FID17:WR  
Sample : WG1676456-1,42,,  
Misc : WG1676467,WG1676456,ICAL18753  
ALS Vial : 26 Sample Multiplier: 1

Integration File: autoint1.e  
Quant Time: Oct 21 17:12:14 2022  
Quant Method : C:\Projects\Hawaii DOH\2. Laboratory Data\Alpha\Carbon Range Study\L2240634\TPH\NF TPH\NF TPH ( )  
Quant Title : FID Forensics  
QLast Update : Fri Sep 23 15:53:13 2022  
Response via : Initial Calibration  
Integrator: ChemStation 6890 Scale Mode: Large solvent peaks clipped

Volume Inj. :  
Signal Phase :  
Signal Info :

Compound	R.T.	Response	Conc Units
<b>Internal Standards</b>			
1) I 5-alpha-androstane	30.257	60790287	50.000 ug/mLm
<b>System Monitoring Compounds</b>			
3) s d50-Tetracosane	35.017	49093075	48.857 ug/mLm
Spiked Amount 50.000 Range 50 - 130 Recovery = 97.71%			
<b>Target Compounds</b>			
4) h > C8 to C10 Aliphatics	7.069	27481478	23.995 ug/mLm
5) h > C10 to C12 Aliphatics	11.972	7681627	6.707 ug/mlm
6) h > C12 to C16 Aliphatics	16.680	2006465	1.752 UG/MLm
7) h > C16 to C21 Aliphatics	28.281	4168073	3.639 UG/MLm
8) h > C21 to C32 Aliphatics	32.785	23445315	20.471 UG/MLm
9) h > C8 to C10 Aromatics	7.069	27566135	24.069 UG/MLm
10) h > C10 to C12 Aromatics	11.972	6721338	5.869 UG/MLm
11) h > C12 to C16 Aromatics	16.680	2039906	1.781 UG/MLm
12) h > C16 to C21 Aromatics	28.281	4238839	3.701 UG/MLm
13) h > C21 to C32 Aromatics	32.785	23633302	20.635 UG/MLm

SemiQuant Compounds - Not Calibrated on this Instrument

(f)=RT Delta > 1/2 Window

(m)=manual int.

Quantitation Report (QT Reviewed)

Data Path : C:\Projects\Hawaii DOH\2. Laboratory Data\Alpha\Carbon Range Study\L2240634\TPH\NF TPH\  
Data File : f1708172252.D  
Signal(s) : FID1A.CH  
Acq On : 19 Aug 2022 1:49 am  
Operator : FID17:WR  
Sample : WG1676456-1,42,,  
Misc : WG1676467,WG1676456,ICAL18753  
ALS Vial : 26 Sample Multiplier: 1

Integration File: autoint1.e  
Quant Time: Oct 21 17:12:14 2022  
Quant Method : C:\Projects\Hawaii DOH\2. Laboratory Data\Alpha\Carbon Range Study\L2240634\TPH\NF TPH\NF TPH  
Quant Title : FID Forensics  
QLast Update : Fri Sep 23 15:53:13 2022  
Response via : Initial Calibration  
Integrator: ChemStation 6890 Scale Mode: Large solvent peaks clipped

Volume Inj. :  
Signal Phase :  
Signal Info :

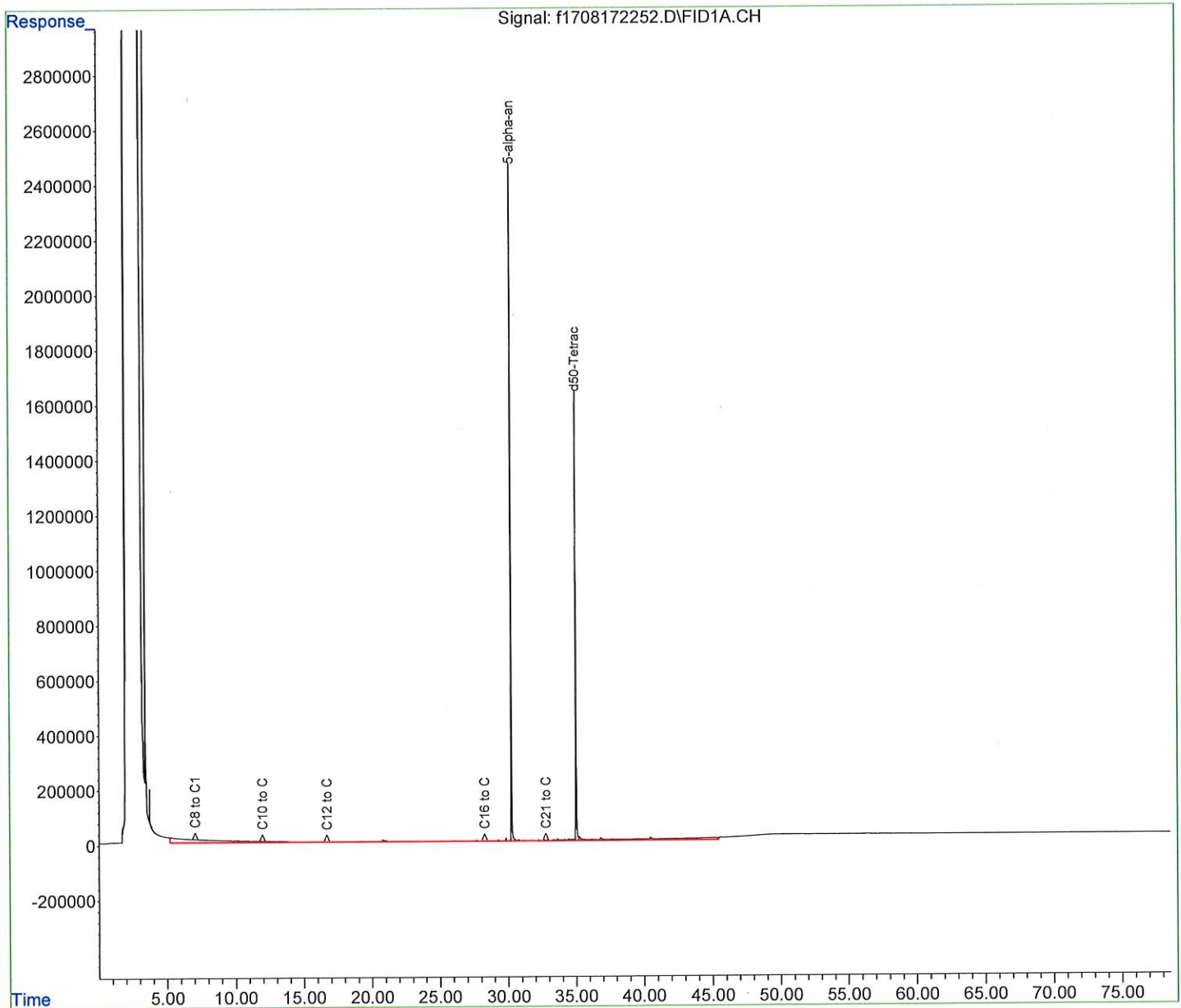

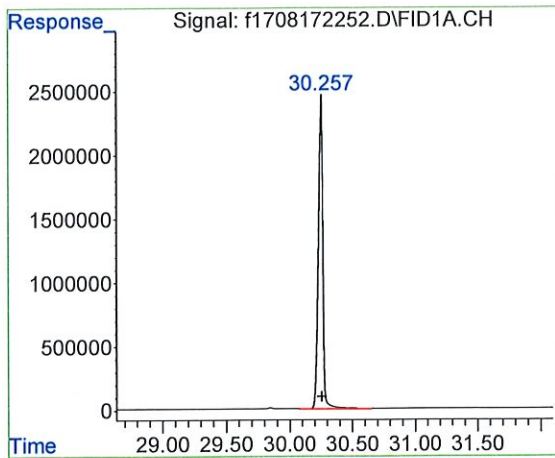

#1 5-alpha-androstane  
 R.T.: 30.257 min  
 Delta R.T.: 0.000 min  
 Response: 60790287  
 Conc: 50.00 ug/mL m

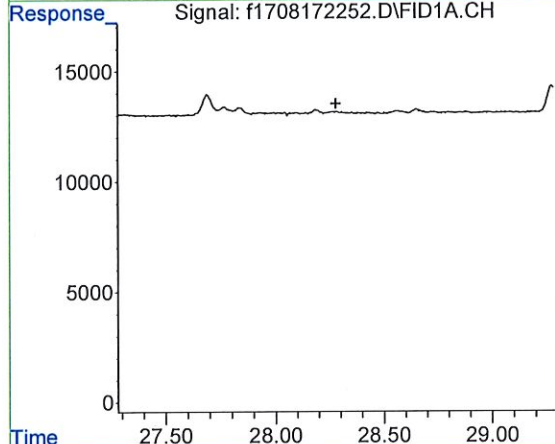

#2 ortho-terphenyl  
 R.T.: 0.000 min  
 Exp R.T. : 28.281 min  
 Response: 0  
 Conc: N.D.

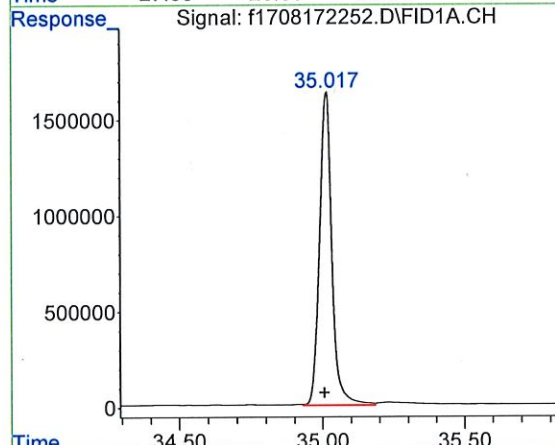

#3 d50-Tetracosane  
 R.T.: 35.017 min  
 Delta R.T.: 0.010 min  
 Response: 49093075  
 Conc: 48.86 ug/mL m

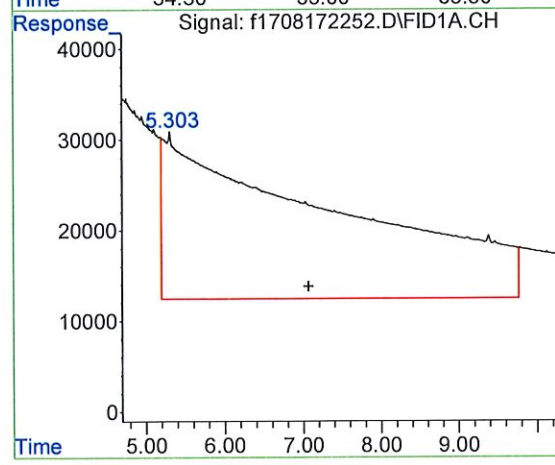

#4 > C8 to C10 Aliphatics  
 R.T.: 7.069 min  
 Delta R.T.: 0.000 min  
 Response: 27481478  
 Conc: 23.99 ug/mL m

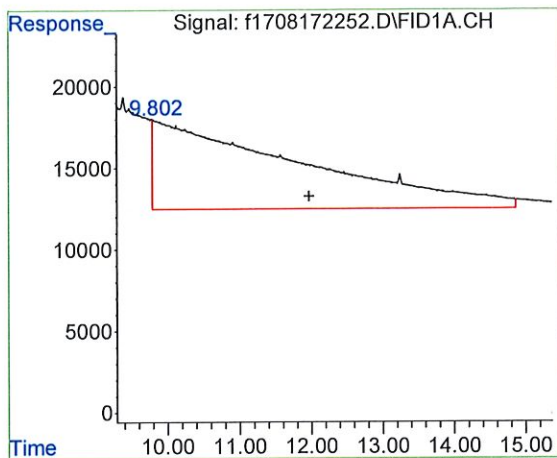

#5 > C10 to C12 Aliphatics

R.T.: 11.972 min  
 Delta R.T.: 0.000 min  
 Response: 7681627  
 Conc: 6.71 ug/ml m

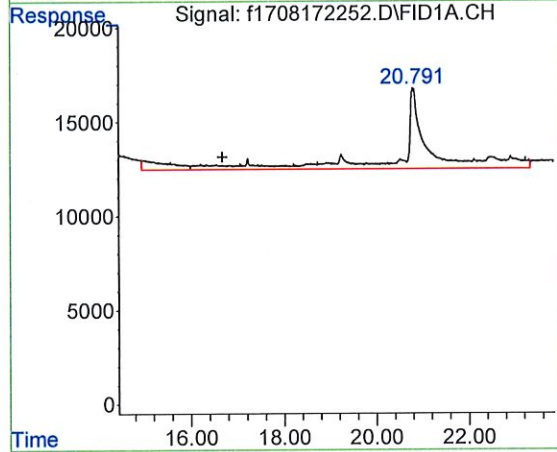

#6 > C12 to C16 Aliphatics

R.T.: 16.680 min  
 Delta R.T.: 0.000 min  
 Response: 2006465  
 Conc: 1.75 UG/ML m

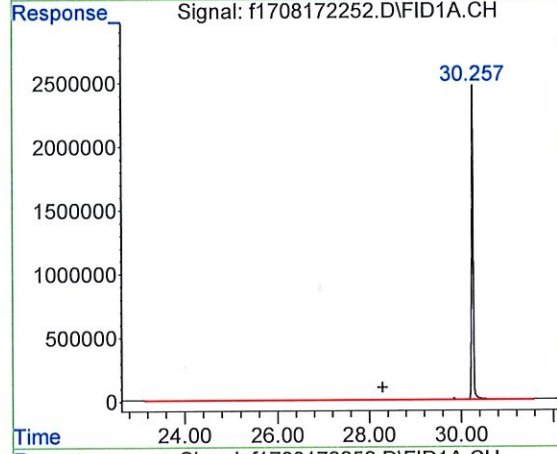

#7 > C16 to C21 Aliphatics

R.T.: 28.281 min  
 Delta R.T.: 0.000 min  
 Response: 4168073  
 Conc: 3.64 UG/ML m

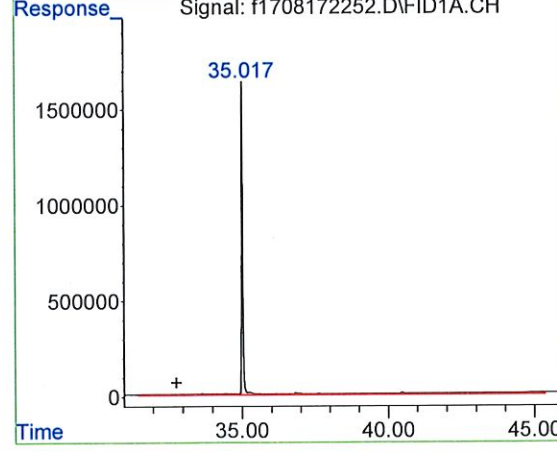

#8 > C21 to C32 Aliphatics

R.T.: 32.785 min  
 Delta R.T.: 0.000 min  
 Response: 23445315  
 Conc: 20.47 UG/ML m

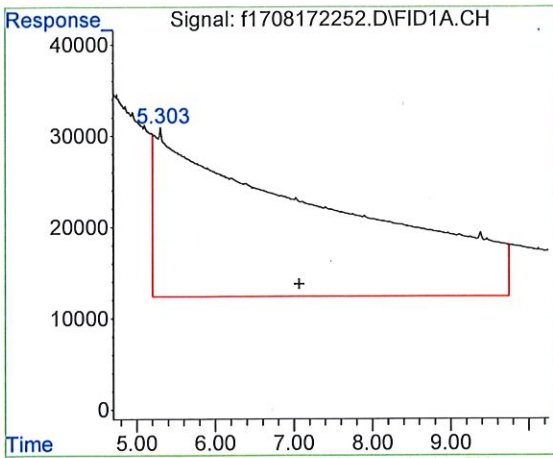

#9 > C8 to C10 Aromatics

R.T.: 7.069 min  
 Delta R.T.: 0.000 min  
 Response: 27566135  
 Conc: 24.07 UG/ML m

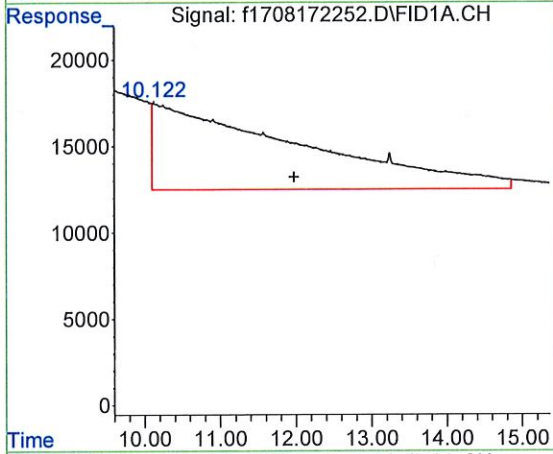

#10 > C10 to C12 Aromatics

R.T.: 11.972 min  
 Delta R.T.: 0.000 min  
 Response: 6721338  
 Conc: 5.87 UG/ML m

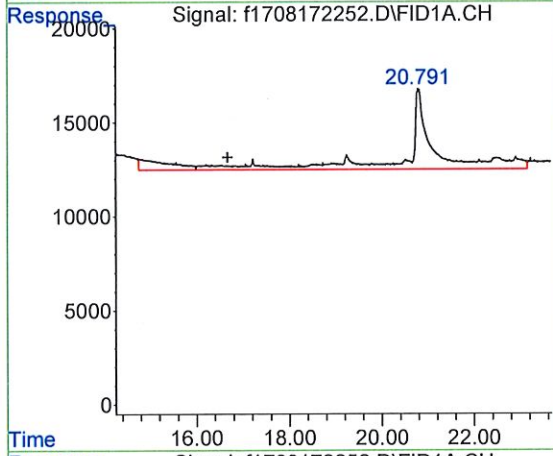

#11 > C12 to C16 Aromatics

R.T.: 16.680 min  
 Delta R.T.: 0.000 min  
 Response: 2039906  
 Conc: 1.78 UG/ML m

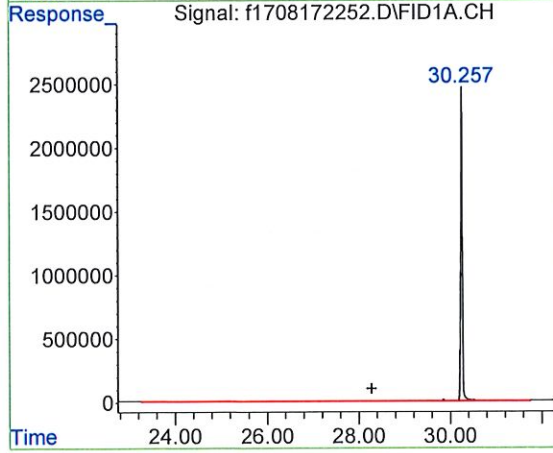

#12 > C16 to C21 Aromatics

R.T.: 28.281 min  
 Delta R.T.: 0.000 min  
 Response: 4238839  
 Conc: 3.70 UG/ML m

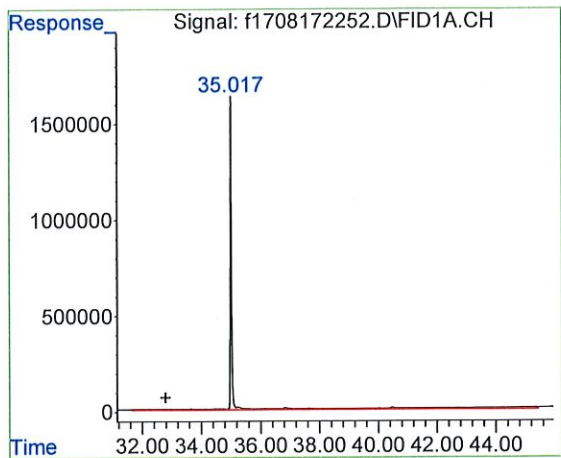

#13 > C21 to C32 Aromatics

R.T.: 32.785 min  
Delta R.T.: 0.000 min  
Response: 23633302  
Conc: 20.63 UG/ML m

Quantitation Report (QT Reviewed)

Data Path : C:\Projects\Hawaii DOH\2. Laboratory Data\Alpha\Carbon Range Study\L2240634\TPH\NF TPH\  
 Data File : f1708172260.D  
 Signal(s) : FID1A.CH  
 Acq On : 19 Aug 2022 7:48 am  
 Operator : FID17:WR  
 Sample : L2240634-02.42,,  
 Misc : WG1676467,WG1676456,ICAL18753  
 ALS Vial : 30 Sample Multiplier: 1

Integration File: autoint1.e  
 Quant Time: Oct 21 17:20:14 2022  
 Quant Method : C:\Projects\Hawaii DOH\2. Laboratory Data\Alpha\Carbon Range Study\L2240634\TPH\NF TPH\NF TPH (   
 Quant Title : FID Forensics  
 QLast Update : Fri Sep 23 15:53:13 2022  
 Response via : Initial Calibration  
 Integrator: ChemStation 6890 Scale Mode: Large solvent peaks clipped

Volume Inj. :  
 Signal Phase :  
 Signal Info :

Compound	R.T.	Response	Conc Units
Internal Standards			
1) l 5-alpha-androstane	30.253	61167035	50.000 ug/mLm
System Monitoring Compounds			
3) s d50-Tetracosane	35.010	48645471	48.113 ug/mLm
Spiked Amount 50.000 Range 50 - 130 Recovery = 96.23%			
Target Compounds			
4) h > C8 to C10 Aliphatics	7.069	446712270	387.635 ug/mLm
5) h > C10 to C12 Aliphatics	11.972	142759669	123.880 ug/mlm
6) h > C12 to C16 Aliphatics	16.680	33496124	29.066 UG/MLm
7) h > C16 to C21 Aliphatics	28.281	11600857	10.067 UG/MLm
8) h > C21 to C32 Aliphatics	32.785	23860579	20.705 UG/MLm

SemiQuant Compounds - Not Calibrated on this Instrument

(f)=RT Delta > 1/2 Window (m)=manual int.

Quantitation Report (QT Reviewed)

Data Path : C:\Projects\Hawaii DOH\2. Laboratory Data\Alpha\Carbon Range Study\L2240634\TPH\NF TPH\  
Data File : f1708172260.D  
Signal(s) : FID1A.CH  
Acq On : 19 Aug 2022 7:48 am  
Operator : FID17:WR  
Sample : L2240634-02.42,,  
Misc : WG1676467,WG1676456,ICAL18753  
ALS Vial : 30 Sample Multiplier: 1

Integration File: autoint1.e  
Quant Time: Oct 21 17:20:14 2022  
Quant Method : C:\Projects\Hawaii DOH\2. Laboratory Data\Alpha\Carbon Range Study\L2240634\TPH\NF TPH\NF TPH  
Quant Title : FID Forensics  
QLast Update : Fri Sep 23 15:53:13 2022  
Response via : Initial Calibration  
Integrator: ChemStation 6890 Scale Mode: Large solvent peaks clipped

Volume Inj. :  
Signal Phase :  
Signal Info :

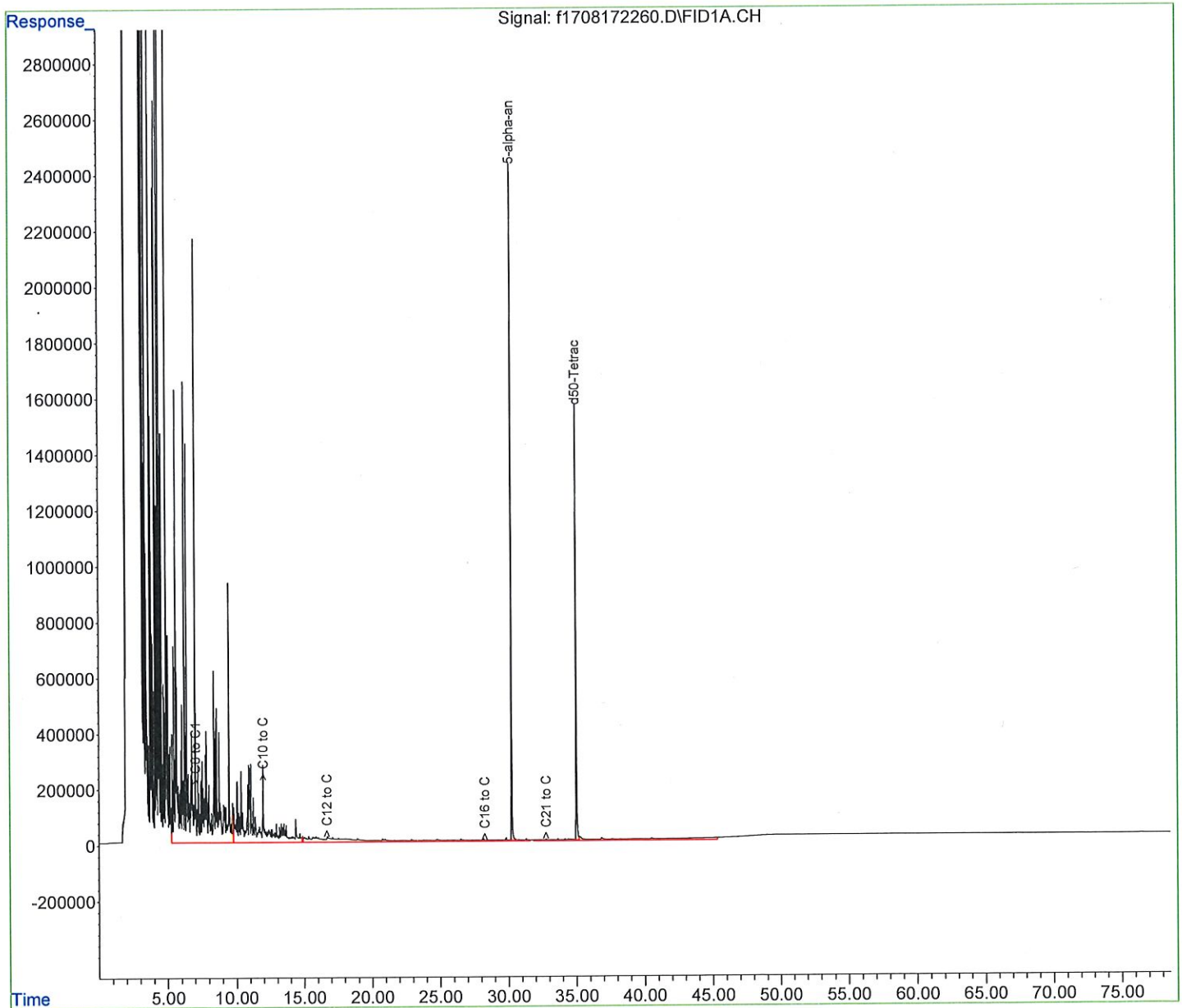



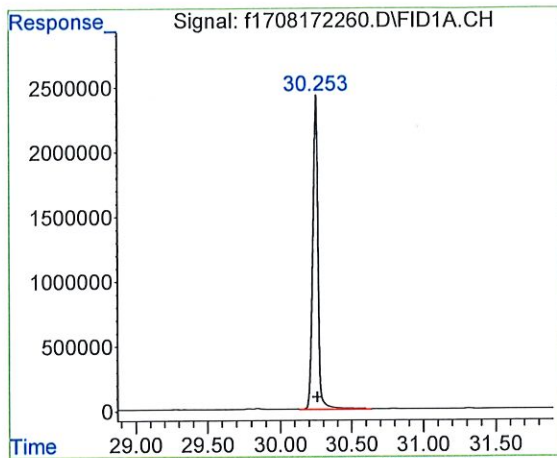

#1 5-alpha-androstane  
 R.T.: 30.253 min  
 Delta R.T.: -0.003 min  
 Response: 61167035  
 Conc: 50.00 ug/mL m

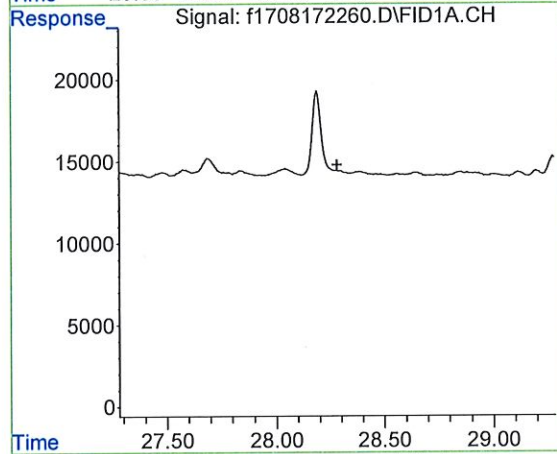

#2 ortho-terphenyl  
 R.T.: 0.000 min  
 Exp R.T. : 28.281 min  
 Response: 0  
 Conc: N.D.

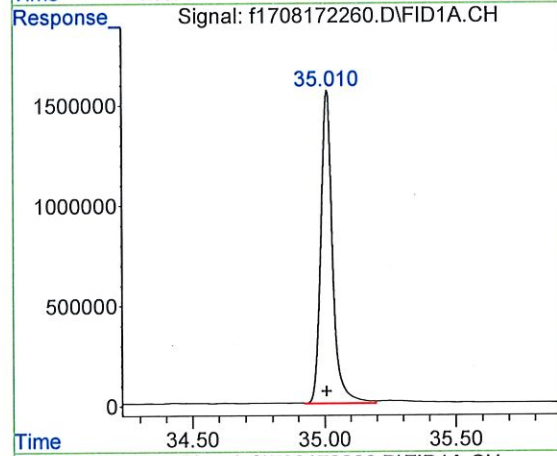

#3 d50-Tetracosane  
 R.T.: 35.010 min  
 Delta R.T.: 0.004 min  
 Response: 48645471  
 Conc: 48.11 ug/mL m

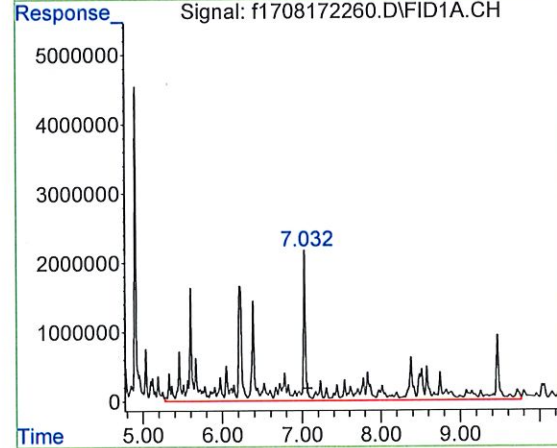

#4 > C8 to C10 Aliphatics  
 R.T.: 7.069 min  
 Delta R.T.: 0.000 min  
 Response: 446712270  
 Conc: 387.64 ug/mL m

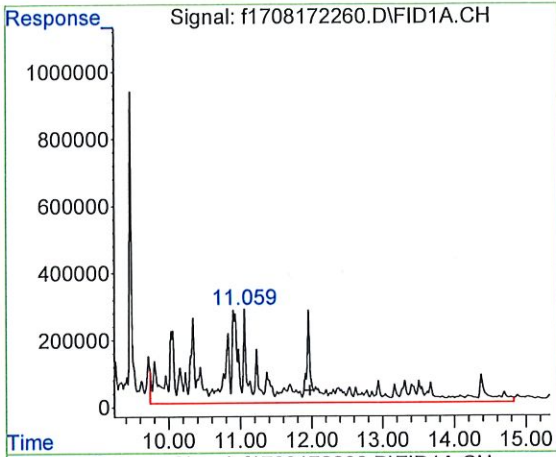

#5 > C10 to C12 Aliphatics  
 R.T.: 11.972 min  
 Delta R.T.: 0.000 min  
 Response: 142759669  
 Conc: 123.88 ug/ml m

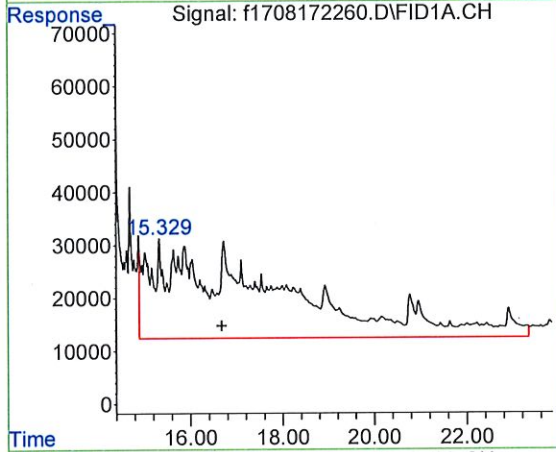

#6 > C12 to C16 Aliphatics  
 R.T.: 16.680 min  
 Delta R.T.: 0.000 min  
 Response: 33496124  
 Conc: 29.07 UG/ML m

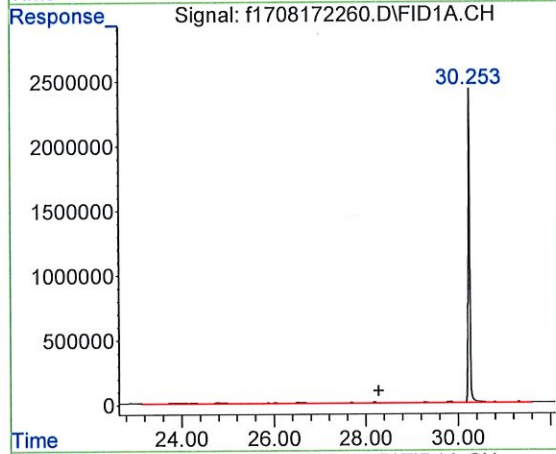

#7 > C16 to C21 Aliphatics  
 R.T.: 28.281 min  
 Delta R.T.: 0.000 min  
 Response: 11600857  
 Conc: 10.07 UG/ML m

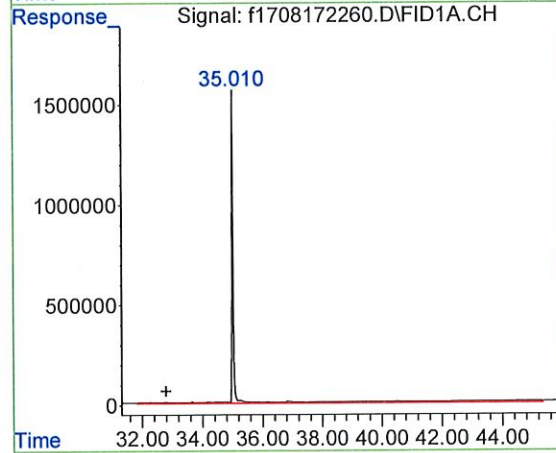

#8 > C21 to C32 Aliphatics  
 R.T.: 32.785 min  
 Delta R.T.: 0.000 min  
 Response: 23860579  
 Conc: 20.71 UG/ML m

Quantitation Report (QT Reviewed)

Data Path : C:\Projects\Hawaii DOH\2. Laboratory Data\Alpha\Carbon Range Study\L2240634\TPH\NF TPH\  
 Data File : f1708172262.D  
 Signal(s) : FID1A.CH  
 Acq On : 19 Aug 2022 9:18 am  
 Operator : FID17:WR  
 Sample : WG1676456-4,42,,  
 Misc : WG1676467,WG1676456,ICAL18753  
 ALS Vial : 31 Sample Multiplier: 1

Integration File: autoint1.e  
 Quant Time: Oct 22 16:45:43 2022  
 Quant Method : C:\Projects\Hawaii DOH\2. Laboratory Data\Alpha\Carbon Range Study\L2240634\TPH\NF TPH\NF TPH (
 Quant Title : FID Forensics  
 QLast Update : Fri Sep 23 15:53:13 2022  
 Response via : Initial Calibration  
 Integrator: ChemStation 6890 Scale Mode: Large solvent peaks clipped

Volume Inj. :  
 Signal Phase :  
 Signal Info :

Compound	R.T.	Response	Conc Units
-----			
Internal Standards			
1) I 5-alpha-androstane	30.253	63639014	50.000 ug/mLm
System Monitoring Compounds			
3) s d50-Tetracosane	35.010	51158551	48.633 ug/mLm
Spiked Amount 50.000 Range 50 - 130 Recovery = 97.27%			
Target Compounds			
4) h > C8 to C10 Aliphatics	7.069	543985759	453.709 ug/mLm
5) h > C10 to C12 Aliphatics	11.972	169891397	141.697 ug/mlm
6) h > C12 to C16 Aliphatics	16.680	37038170	30.892 UG/MLm
7) h > C16 to C21 Aliphatics	28.281	11079278	9.241 UG/MLm
8) h > C21 to C32 Aliphatics	32.785	25033312	20.879 UG/MLm

SemiQuant Compounds - Not Calibrated on this Instrument

(f)=RT Delta > 1/2 Window (m)=manual int.

Quantitation Report (QT Reviewed)

Data Path : C:\Projects\Hawaii DOH\2. Laboratory Data\Alpha\Carbon Range Study\L2240634\TPH\NF TPH\  
Data File : f1708172262.D  
Signal(s) : FID1A.CH  
Acq On : 19 Aug 2022 9:18 am  
Operator : FID17:WR  
Sample : WG1676456-4,42,,  
Misc : WG1676467,WG1676456,ICAL18753  
ALS Vial : 31 Sample Multiplier: 1

Integration File: autoint1.e  
Quant Time: Oct 22 16:45:43 2022  
Quant Method : C:\Projects\Hawaii DOH\2. Laboratory Data\Alpha\Carbon Range Study\L2240634\TPH\NF TPH\  
Quant Title : FID Forensics  
QLast Update : Fri Sep 23 15:53:13 2022  
Response via : Initial Calibration  
Integrator: ChemStation 6890 Scale Mode: Large solvent peaks clipped

Volume Inj. :  
Signal Phase :  
Signal Info :

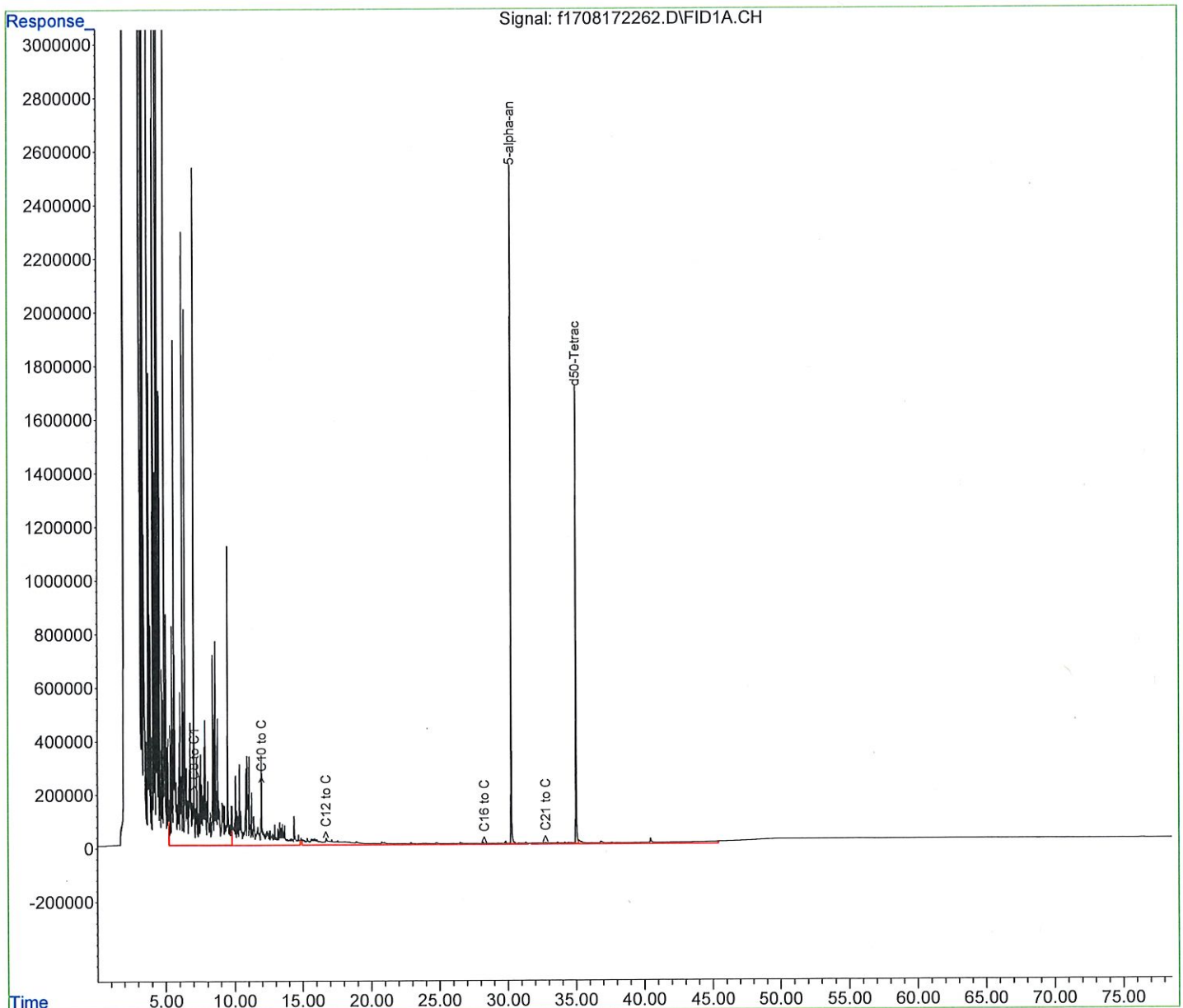

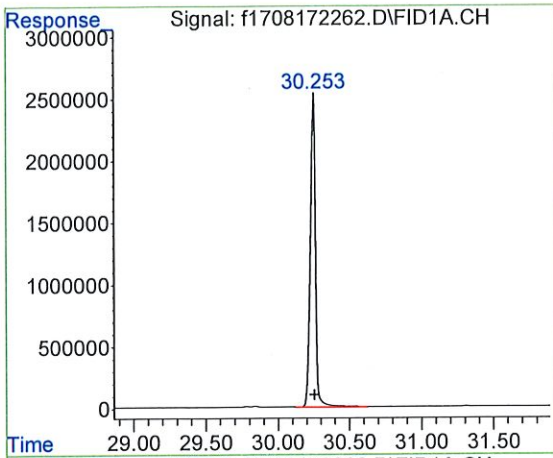

#1 5-alpha-androstane  
 R.T.: 30.253 min  
 Delta R.T.: -0.004 min  
 Response: 63639014  
 Conc: 50.00 ug/mL m

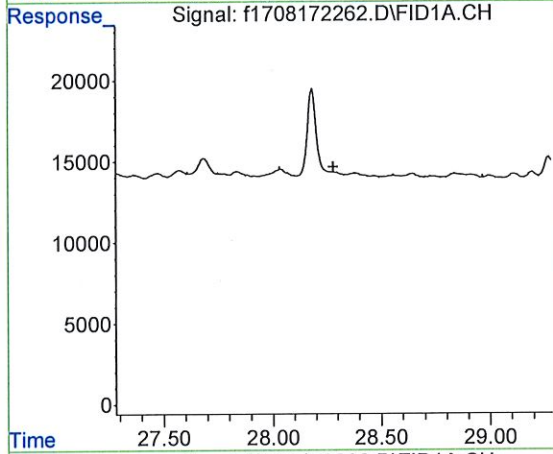

#2 ortho-terphenyl  
 R.T.: 0.000 min  
 Exp R.T. : 28.281 min  
 Response: 0  
 Conc: N.D.

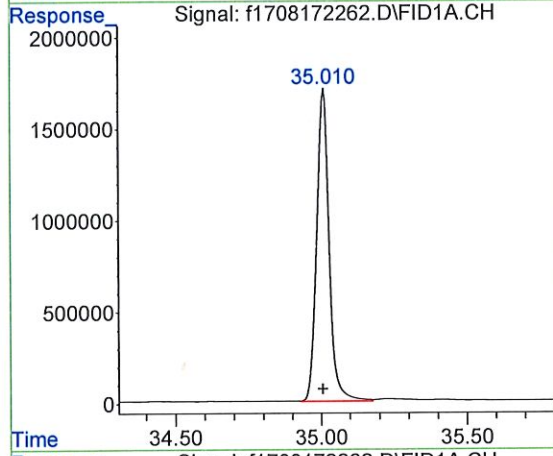

#3 d50-Tetracosane  
 R.T.: 35.010 min  
 Delta R.T.: 0.004 min  
 Response: 51158551  
 Conc: 48.63 ug/mL m

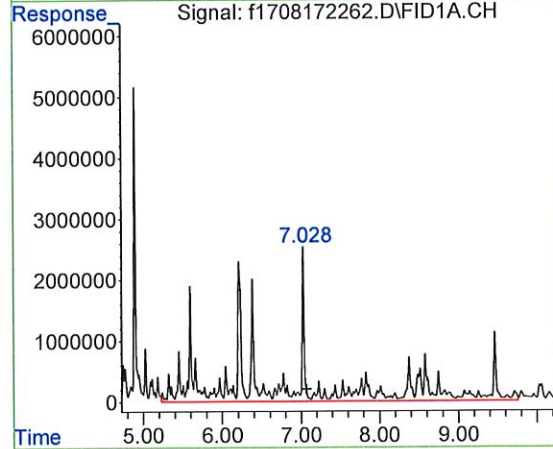

#4 > C8 to C10 Aliphatics  
 R.T.: 7.069 min  
 Delta R.T.: 0.000 min  
 Response: 543985759  
 Conc: 453.71 ug/mL m

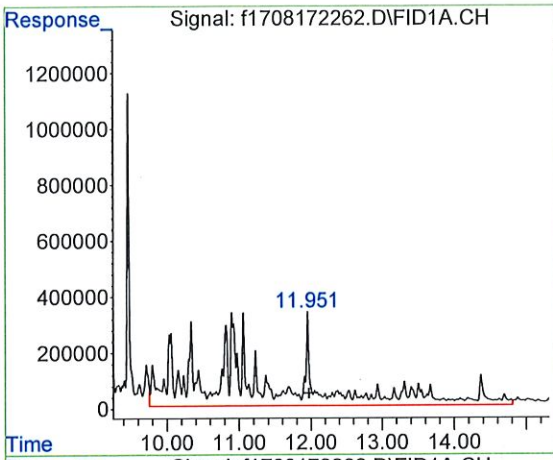

#5 > C10 to C12 Aliphatics

R.T.: 11.972 min  
 Delta R.T.: 0.000 min  
 Response: 169891397  
 Conc: 141.70 ug/ml m

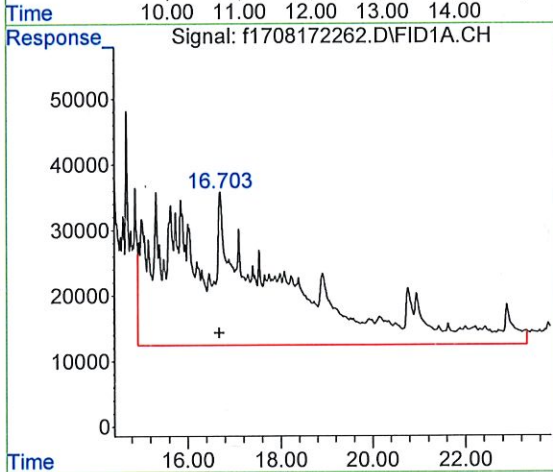

#6 > C12 to C16 Aliphatics

R.T.: 16.680 min  
 Delta R.T.: 0.000 min  
 Response: 37038170  
 Conc: 30.89 UG/ML m

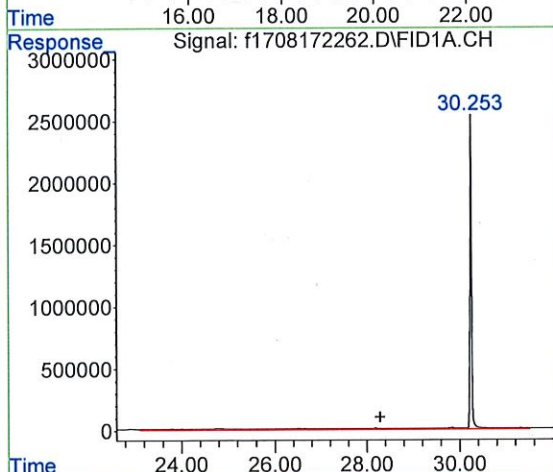

#7 > C16 to C21 Aliphatics

R.T.: 28.281 min  
 Delta R.T.: 0.000 min  
 Response: 11079278  
 Conc: 9.24 UG/ML m

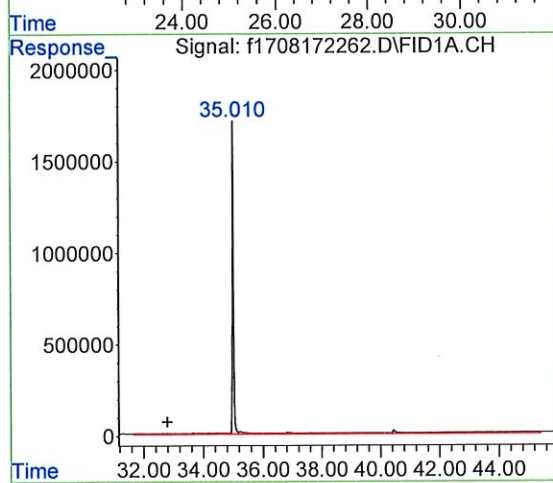

#8 > C21 to C32 Aliphatics

R.T.: 32.785 min  
 Delta R.T.: 0.000 min  
 Response: 25033312  
 Conc: 20.88 UG/ML m

Quantitation Report (QT Reviewed)

Data Path : C:\Projects\Hawaii DOH\2. Laboratory Data\Alpha\Carbon Range Study\L2240634\TPH\NF TPH\  
Data File : f1708172264.D  
Signal(s) : FID1A.CH  
Acq On : 19 Aug 2022 10:49 am  
Operator : FID17:WR  
Sample : L2240634-05,42,,  
Misc : WG1676467,WG1676456,ICAL18753  
ALS Vial : 32 Sample Multiplier: 1

Integration File: autoint1.e  
Quant Time: Oct 22 16:55:34 2022  
Quant Method : C:\Projects\Hawaii DOH\2. Laboratory Data\Alpha\Carbon Range Study\L2240634\TPH\NF TPH\NF TPH (   
Quant Title : FID Forensics  
QLast Update : Fri Sep 23 15:53:13 2022  
Response via : Initial Calibration  
Integrator: ChemStation 6890 Scale Mode: Large solvent peaks clipped

Volume Inj. :  
Signal Phase :  
Signal Info :

Compound	R.T.	Response	Conc Units
-----			
Internal Standards			
1) l 5-alpha-androstane	30.253	66028062	50.000 ug/mLm
System Monitoring Compounds			
3) s d50-Tetracosane	35.009	50960795	46.692 ug/mLm
Spiked Amount 50.000 Range 50 - 130 Recovery = 93.38%			
Target Compounds			
4) h > C8 to C10 Aliphatics	7.069	492283944	395.731 ug/mLm
5) h > C10 to C12 Aliphatics	11.972	146658507	117.894 ug/mlm
6) h > C12 to C16 Aliphatics	16.680	30173126	24.255 UG/MLm
7) h > C16 to C21 Aliphatics	28.281	9278829	7.459 UG/MLm
8) h > C21 to C32 Aliphatics	32.785	23160922	18.618 UG/MLm

SemiQuant Compounds - Not Calibrated on this Instrument

(f)=RT Delta > 1/2 Window (m)=manual int.

Quantitation Report (QT Reviewed)

Data Path : C:\Projects\Hawaii DOH\2. Laboratory Data\Alpha\Carbon Range Study\L2240634\TPH\NF TPH\  
Data File : f1708172264.D  
Signal(s) : FID1A.CH  
Acq On : 19 Aug 2022 10:49 am  
Operator : FID17:WR  
Sample : L2240634-05,42,,  
Misc : WG1676467,WG1676456,ICAL18753  
ALS Vial : 32 Sample Multiplier: 1

Integration File: autoint1.e  
Quant Time: Oct 22 16:55:34 2022  
Quant Method : C:\Projects\Hawaii DOH\2. Laboratory Data\Alpha\Carbon Range Study\L2240634\TPH\NF TPH\NF TPH  
Quant Title : FID Forensics  
QLast Update : Fri Sep 23 15:53:13 2022  
Response via : Initial Calibration  
Integrator: ChemStation 6890 Scale Mode: Large solvent peaks clipped

Volume Inj. :  
Signal Phase :  
Signal Info :

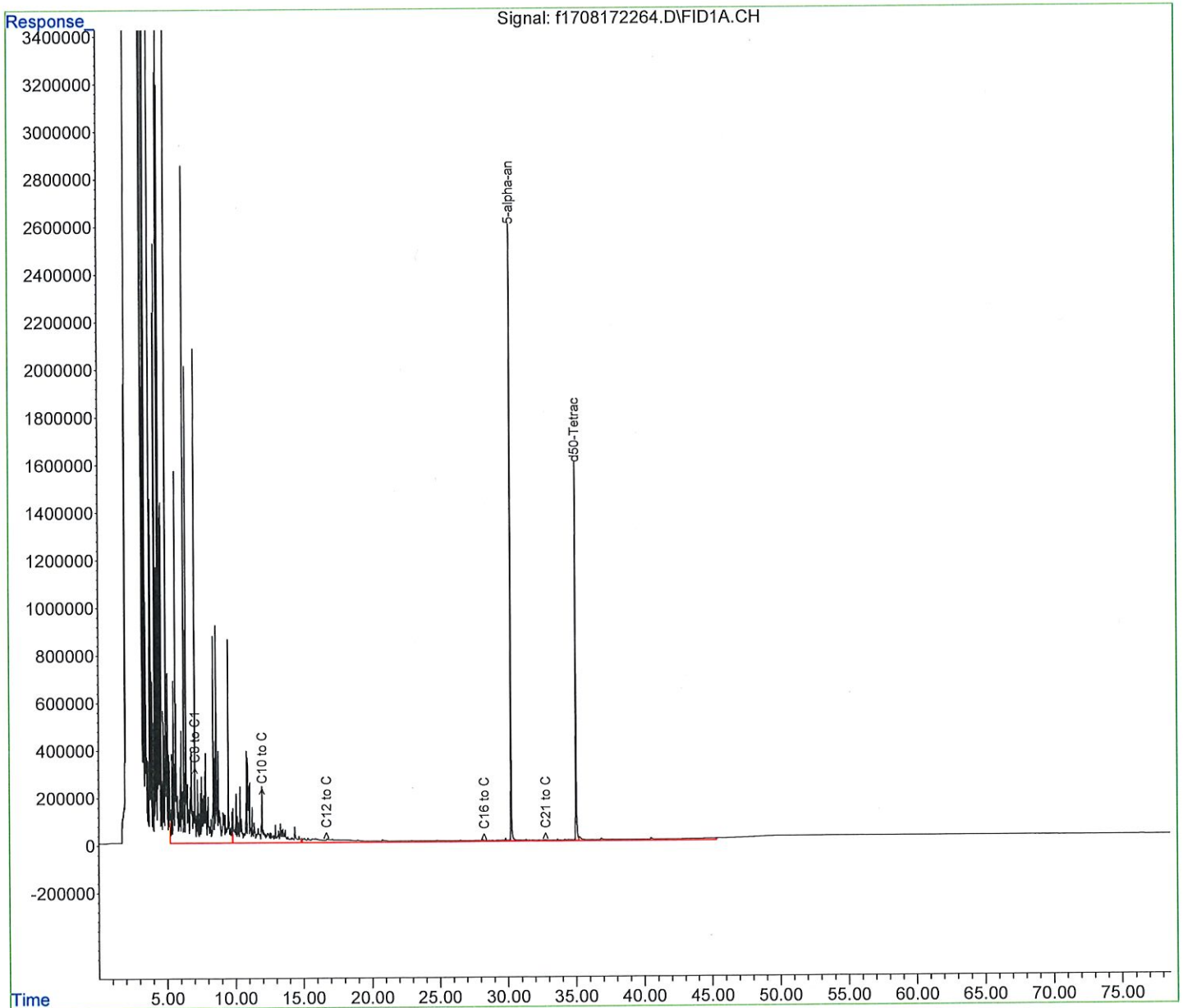



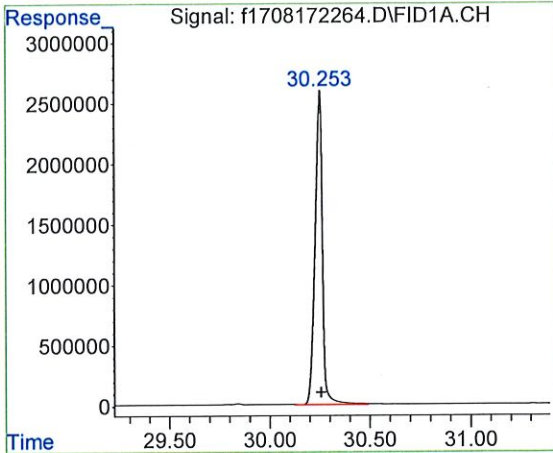

#1 5-alpha-androstane  
 R.T.: 30.253 min  
 Delta R.T.: -0.004 min  
 Response: 66028062  
 Conc: 50.00 ug/mL m

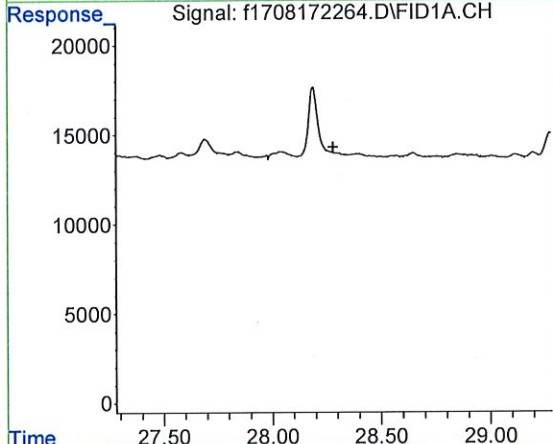

#2 ortho-terphenyl  
 R.T.: 0.000 min  
 Exp R.T. : 28.281 min  
 Response: 0  
 Conc: N.D.

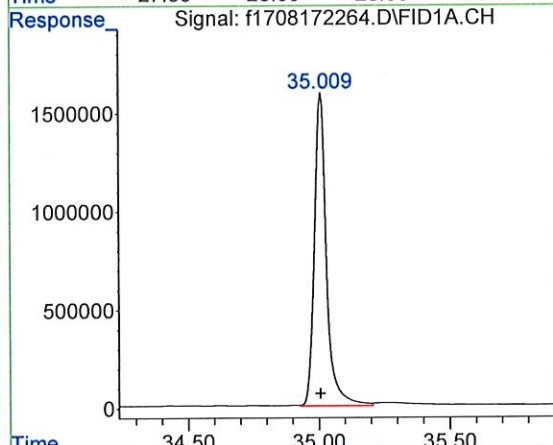

#3 d50-Tetracosane  
 R.T.: 35.009 min  
 Delta R.T.: 0.003 min  
 Response: 50960795  
 Conc: 46.69 ug/mL m

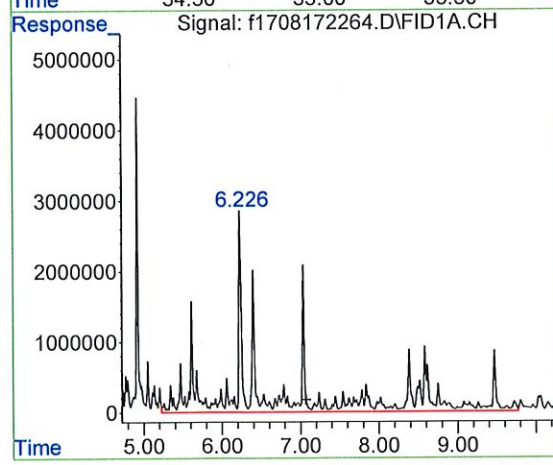

#4 > C8 to C10 Aliphatics  
 R.T.: 7.069 min  
 Delta R.T.: 0.000 min  
 Response: 492283944  
 Conc: 395.73 ug/mL m

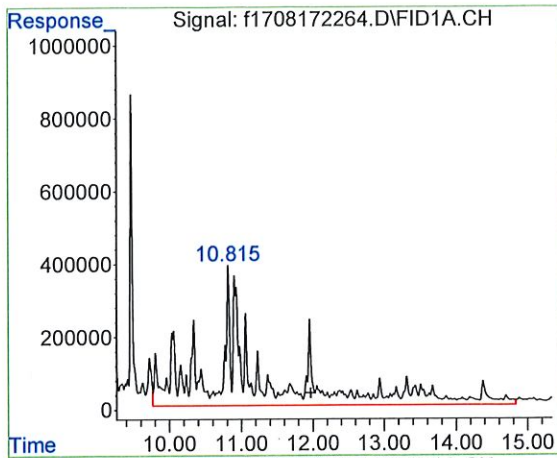

#5 > C10 to C12 Aliphatics

R.T.: 11.972 min  
 Delta R.T.: 0.000 min  
 Response: 146658507  
 Conc: 117.89 ug/ml m

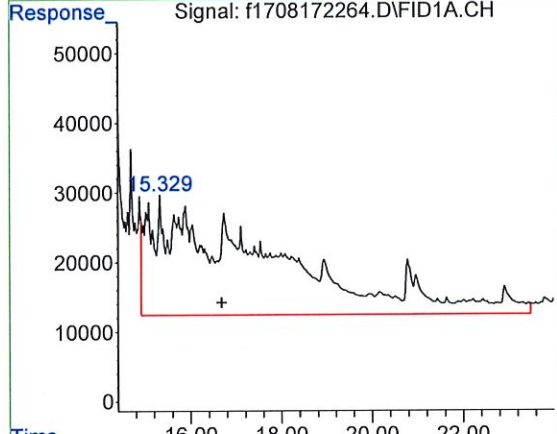

#6 > C12 to C16 Aliphatics

R.T.: 16.680 min  
 Delta R.T.: 0.000 min  
 Response: 30173126  
 Conc: 24.26 UG/ML m

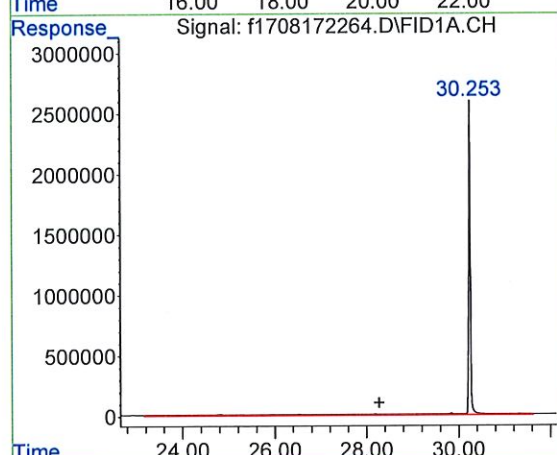

#7 > C16 to C21 Aliphatics

R.T.: 28.281 min  
 Delta R.T.: 0.000 min  
 Response: 9278829  
 Conc: 7.46 UG/ML m

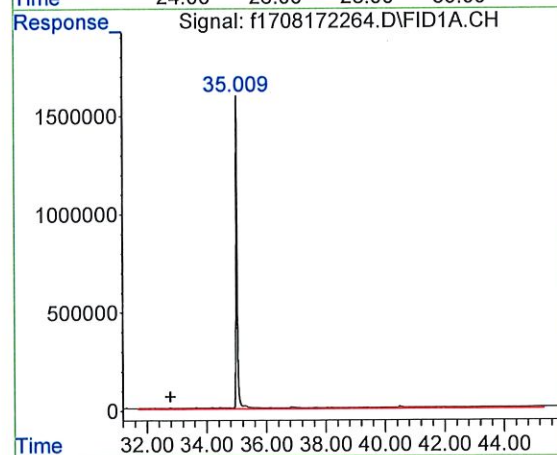

#8 > C21 to C32 Aliphatics

R.T.: 32.785 min  
 Delta R.T.: 0.000 min  
 Response: 23160922  
 Conc: 18.62 UG/ML m

Quantitation Report (QT Reviewed)

Data Path : C:\Projects\Hawaii DOH\2. Laboratory Data\Alpha\Carbon Range Study\L2240634\TPH\NF TPH\  
Data File : f1708172266.D  
Signal(s) : FID1A.CH  
Acq On : 19 Aug 2022 12:21 pm  
Operator : FID17:WR  
Sample : L2240634-08,42,,  
Misc : WG1676467,WG1676456,ICAL18753  
ALS Vial : 33 Sample Multiplier: 1

Integration File: autoint1.e  
Quant Time: Oct 22 17:03:41 2022  
Quant Method : C:\Projects\Hawaii DOH\2. Laboratory Data\Alpha\Carbon Range Study\L2240634\TPH\NF TPH\NF TPH (   
Quant Title : FID Forensics  
QLast Update : Fri Sep 23 15:53:13 2022  
Response via : Initial Calibration  
Integrator: ChemStation 6890 Scale Mode: Large solvent peaks clipped

Volume Inj. :  
Signal Phase :  
Signal Info :

Compound	R.T.	Response	Conc Units
-----			
Internal Standards			
1) l 5-alpha-androstane	30.252	63680700	50.000 ug/mLm
System Monitoring Compounds			
3) s d50-Tetracosane	35.010	50818704	48.278 ug/mLm
Spiked Amount 50.000 Range 50 - 130 Recovery = 96.56%			
Target Compounds			
4) h > C8 to C10 Aliphatics	7.069	452285967	376.980 ug/mLm
5) h > C10 to C12 Aliphatics	11.972	129249544	107.729 ug/mlm
6) h > C12 to C16 Aliphatics	16.680	29034071	24.200 UG/MLm
7) h > C16 to C21 Aliphatics	28.281	9145590	7.623 UG/MLm
8) h > C21 to C32 Aliphatics	32.785	23869912	19.896 UG/MLm

SemiQuant Compounds - Not Calibrated on this Instrument

(f)=RT Delta > 1/2 Window (m)=manual int.

Quantitation Report (QT Reviewed)

Data Path : C:\Projects\Hawaii DOH\2. Laboratory Data\Alpha\Carbon Range Study\L2240634\TPH\NF TPH\  
Data File : f1708172266.D  
Signal(s) : FID1A.CH  
Acq On : 19 Aug 2022 12:21 pm  
Operator : FID17:WR  
Sample : L2240634-08,42,,  
Misc : WG1676467,WG1676456,ICAL18753  
ALS Vial : 33 Sample Multiplier: 1

Integration File: autoint1.e  
Quant Time: Oct 22 17:03:41 2022  
Quant Method : C:\Projects\Hawaii DOH\2. Laboratory Data\Alpha\Carbon Range Study\L2240634\TPH\NF TPH\NF TPH  
Quant Title : FID Forensics  
QLast Update : Fri Sep 23 15:53:13 2022  
Response via : Initial Calibration  
Integrator: ChemStation 6890 Scale Mode: Large solvent peaks clipped

Volume Inj. :  
Signal Phase :  
Signal Info :

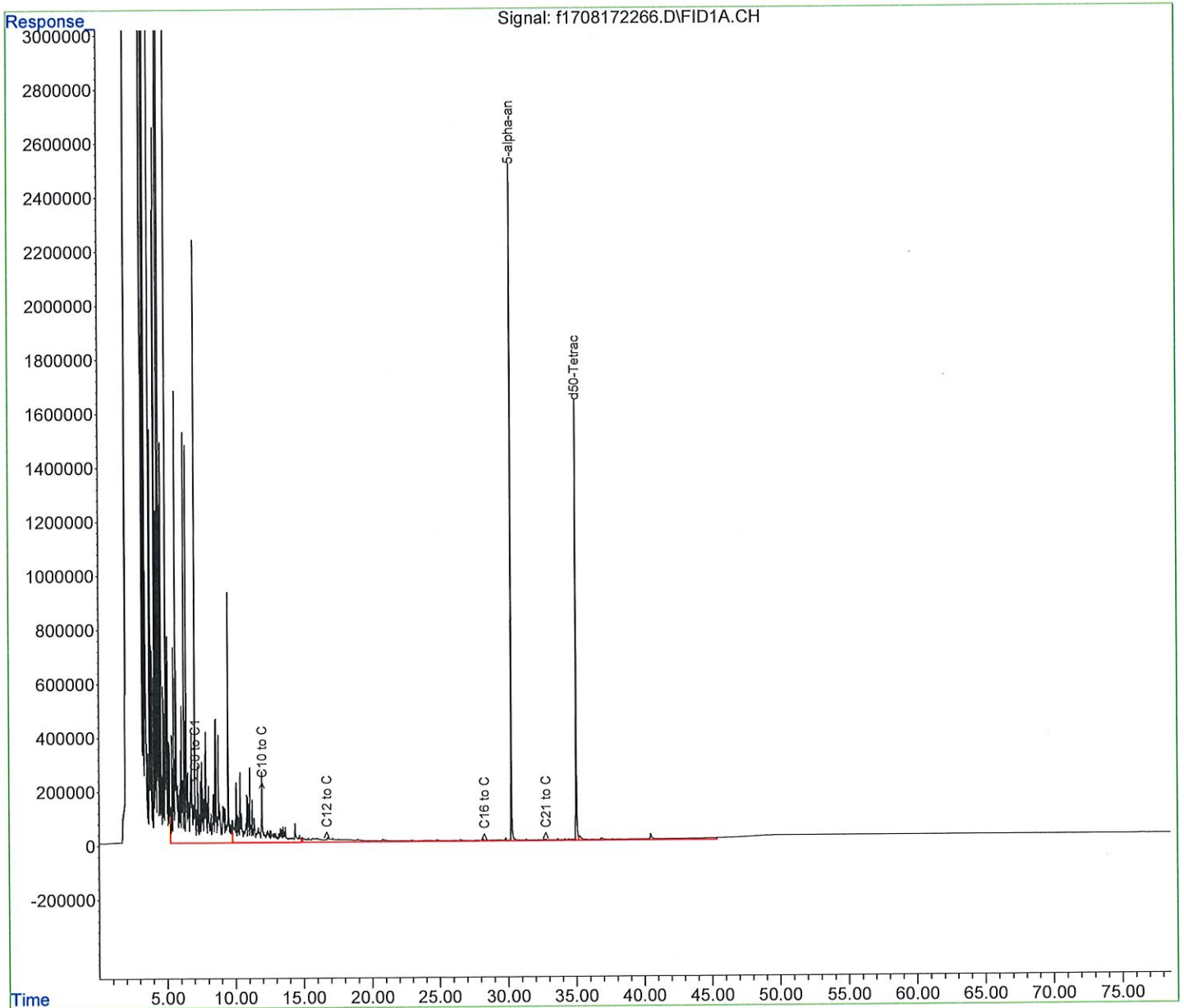

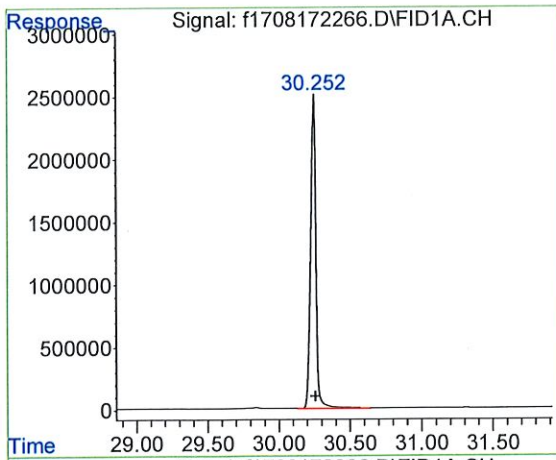

#1 5-alpha-androstane  
 R.T.: 30.252 min  
 Delta R.T.: -0.005 min  
 Response: 63680700  
 Conc: 50.00 ug/mL m

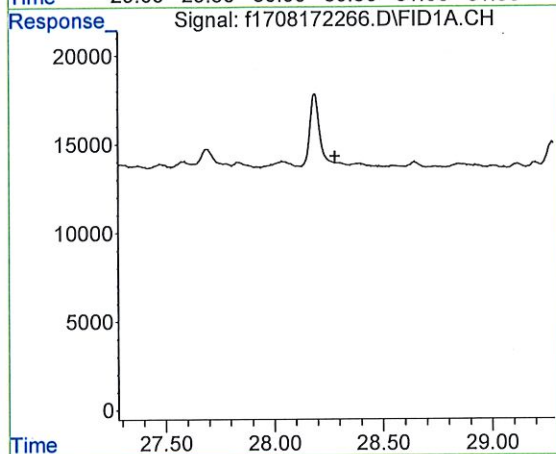

#2 ortho-terphenyl  
 R.T.: 0.000 min  
 Exp R.T. : 28.281 min  
 Response: 0  
 Conc: N.D.

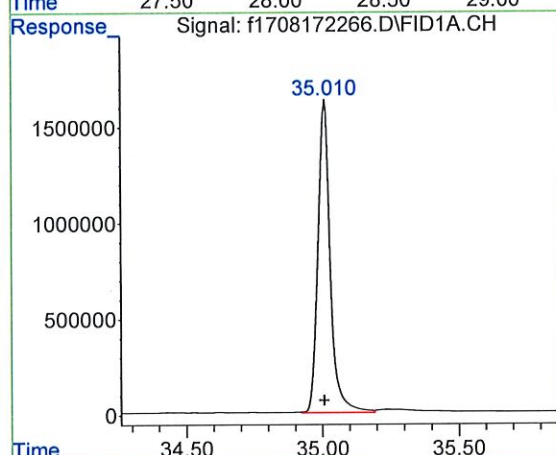

#3 d50-Tetracosane  
 R.T.: 35.010 min  
 Delta R.T.: 0.004 min  
 Response: 50818704  
 Conc: 48.28 ug/mL m

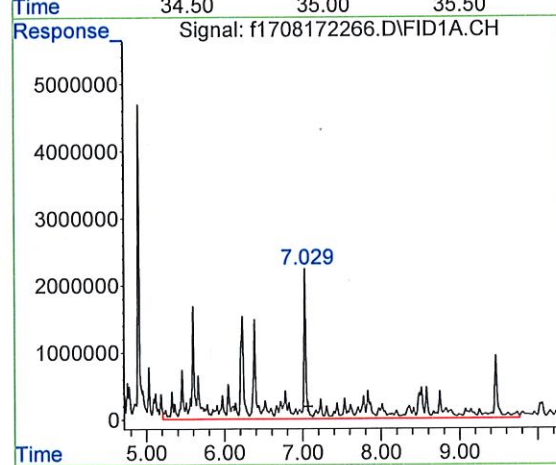

#4 > C8 to C10 Aliphatics  
 R.T.: 7.069 min  
 Delta R.T.: 0.000 min  
 Response: 452285967  
 Conc: 376.98 ug/mL m

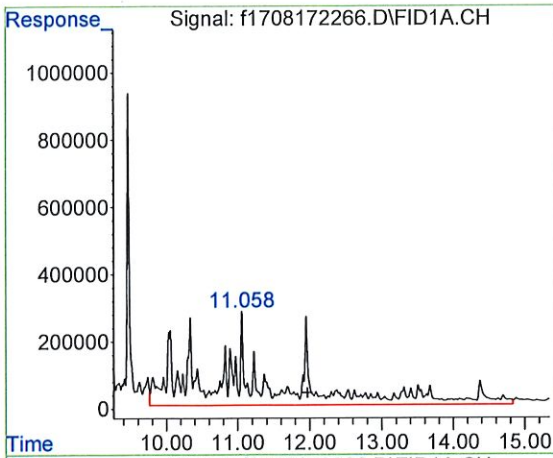

#5 > C10 to C12 Aliphatics

R.T.: 11.972 min  
 Delta R.T.: 0.000 min  
 Response: 129249544  
 Conc: 107.73 ug/ml m

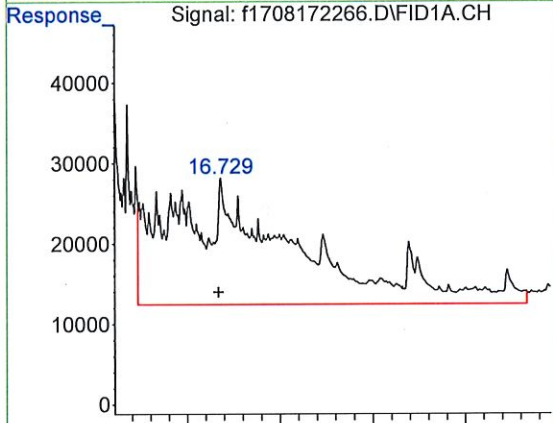

#6 > C12 to C16 Aliphatics

R.T.: 16.680 min  
 Delta R.T.: 0.000 min  
 Response: 29034071  
 Conc: 24.20 UG/ML m

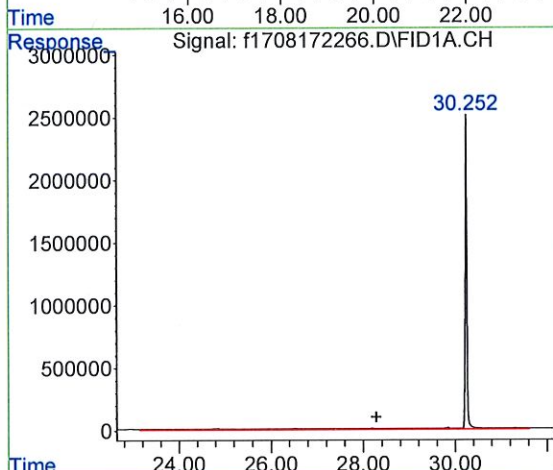

#7 > C16 to C21 Aliphatics

R.T.: 28.281 min  
 Delta R.T.: 0.000 min  
 Response: 9145590  
 Conc: 7.62 UG/ML m

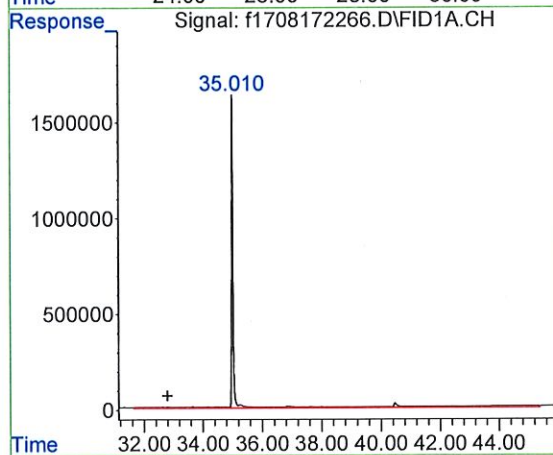

#8 > C21 to C32 Aliphatics

R.T.: 32.785 min  
 Delta R.T.: 0.000 min  
 Response: 23869912  
 Conc: 19.90 UG/ML m

Quantitation Report (QT Reviewed)

Data Path : C:\Projects\Hawaii DOH\2. Laboratory Data\Alpha\Carbon Range Study\L2240634\TPH\NF TPH\  
Data File : f1708172268.D  
Signal(s) : FID1A.CH  
Acq On : 19 Aug 2022 13:52 pm  
Operator : FID17:WR  
Sample : L2240634-11,42,,  
Misc : WG1676467,WG1676456,ICAL18753  
ALS Vial : 34 Sample Multiplier: 1

Integration File: autoint1.e  
Quant Time: Oct 22 17:13:08 2022  
Quant Method : C:\Projects\Hawaii DOH\2. Laboratory Data\Alpha\Carbon Range Study\L2240634\TPH\NF TPH\NF TPH (  
Quant Title : FID Forensics  
QLast Update : Fri Sep 23 15:53:13 2022  
Response via : Initial Calibration  
Integrator: ChemStation 6890 Scale Mode: Large solvent peaks clipped

Volume Inj. :  
Signal Phase :  
Signal Info :

Compound	R.T.	Response	Conc Units
-----			
Internal Standards			
1) l 5-alpha-androstane	30.275	68769343	50.000 ug/mLm
System Monitoring Compounds			
3) s d50-Tetracosane	35.013	55198276	48.559 ug/mLm
Spiked Amount	50.000	Range 50 - 130	Recovery = 97.12%
Target Compounds			
4) h > C8 to C10 Aliphatics	7.069	348108102	268.678 ug/mLm
5) h > C10 to C12 Aliphatics	11.972	1177427463	908.766 ug/mlm
6) h > C12 to C16 Aliphatics	16.680	2953853288	2279.854 UG/MLm
7) h > C16 to C21 Aliphatics	28.281	2420916324	1868.520 UG/MLm
8) h > C21 to C32 Aliphatics	32.785	505923626	390.484 UG/MLm

SemiQuant Compounds - Not Calibrated on this Instrument

-----

(f)=RT Delta > 1/2 Window                      (m)=manual int.

Quantitation Report (QT Reviewed)

Data Path : C:\Projects\Hawaii DOH\2. Laboratory Data\Alpha\Carbon Range Study\L2240634\TPH\NF TPH\  
Data File : f1708172268.D  
Signal(s) : FID1A.CH  
Acq On : 19 Aug 2022 13:52 pm  
Operator : FID17:WR  
Sample : L2240634-11,42,,  
Misc : WG1676467,WG1676456,ICAL18753  
ALS Vial : 34 Sample Multiplier: 1

Integration File: autoint1.e  
Quant Time: Oct 22 17:13:08 2022  
Quant Method : C:\Projects\Hawaii DOH\2. Laboratory Data\Alpha\Carbon Range Study\L2240634\TPH\NF TPH\NF TPH  
Quant Title : FID Forensics  
QLast Update : Fri Sep 23 15:53:13 2022  
Response via : Initial Calibration  
Integrator: ChemStation 6890 Scale Mode: Large solvent peaks clipped

Volume Inj. :  
Signal Phase :  
Signal Info :

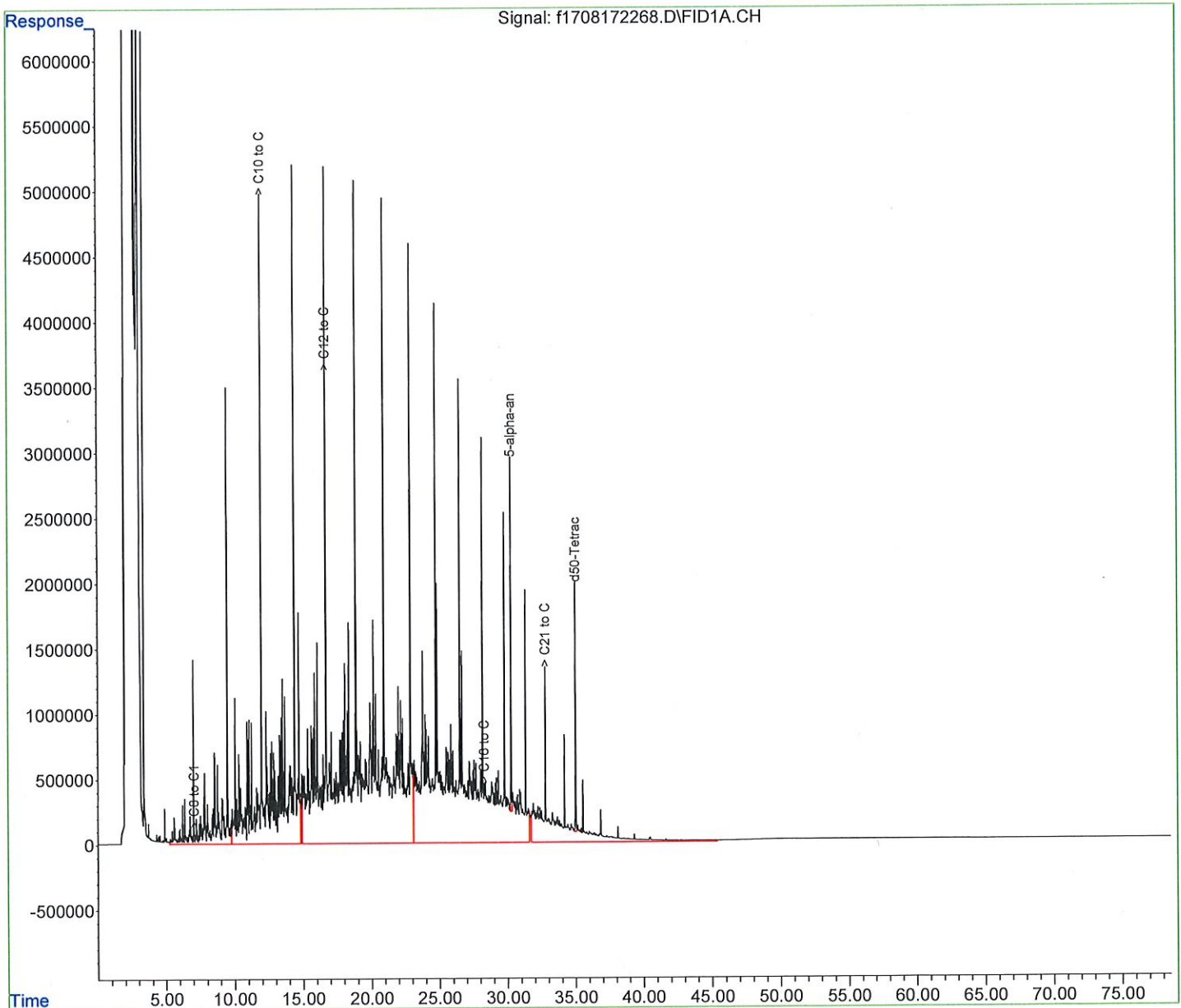



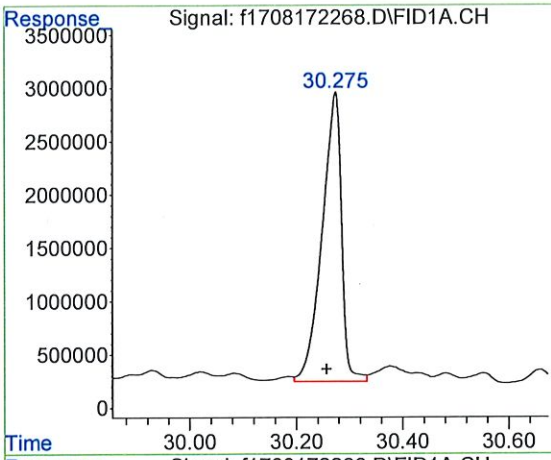

#1 5-alpha-androstane  
 R.T.: 30.275 min  
 Delta R.T.: 0.018 min  
 Response: 68769343  
 Conc: 50.00 ug/mL m

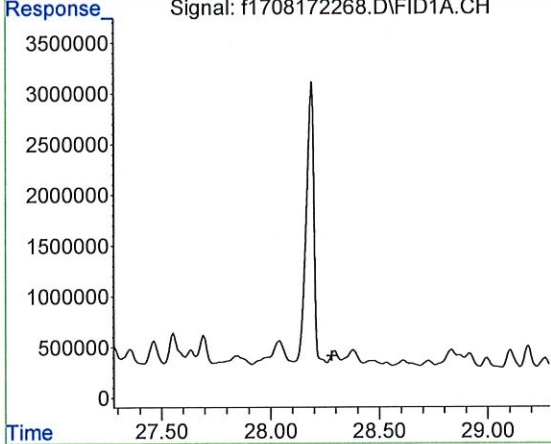

#2 ortho-terphenyl  
 R.T.: 0.000 min  
 Exp R.T. : 28.281 min  
 Response: 0  
 Conc: N.D.

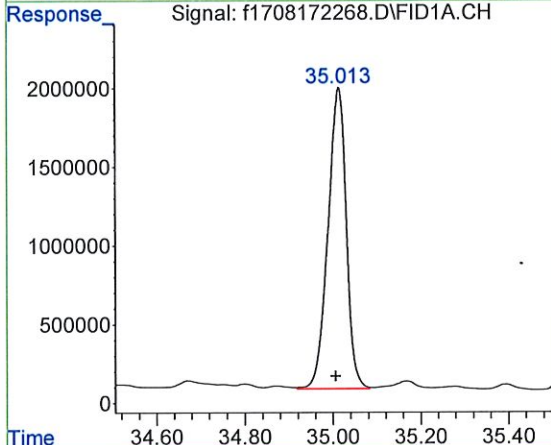

#3 d50-Tetracosane  
 R.T.: 35.013 min  
 Delta R.T.: 0.007 min  
 Response: 55198276  
 Conc: 48.56 ug/mL m

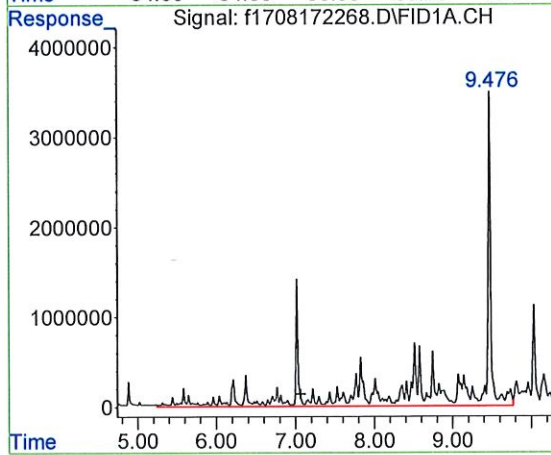

#4 > C8 to C10 Aliphatics  
 R.T.: 7.069 min  
 Delta R.T.: 0.000 min  
 Response: 348108102  
 Conc: 268.68 ug/mL m

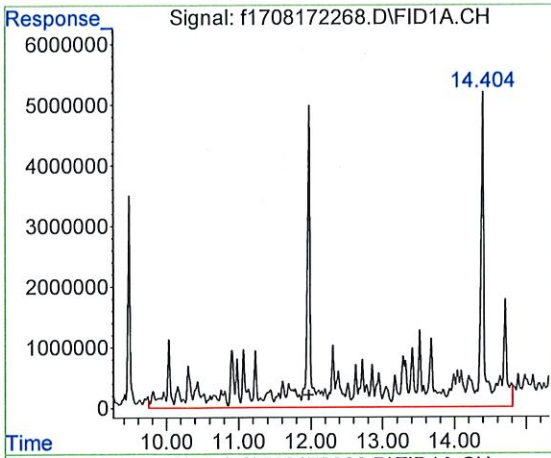

#5 > C10 to C12 Aliphatics

R.T.: 11.972 min  
 Delta R.T.: 0.000 min  
 Response: 1177427463  
 Conc: 908.77 ug/ml m

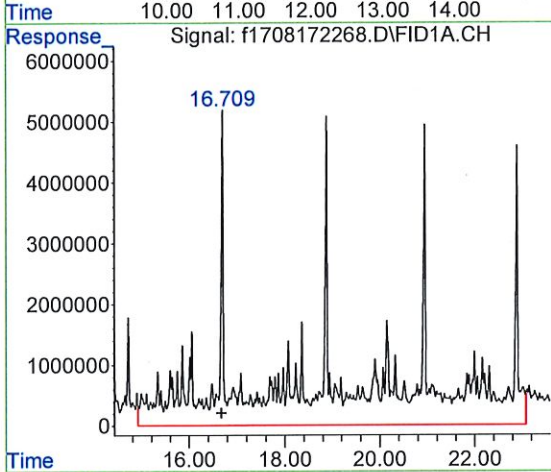

#6 > C12 to C16 Aliphatics

R.T.: 16.680 min  
 Delta R.T.: 0.000 min  
 Response: 2953853288  
 Conc: 2279.85 UG/ML m

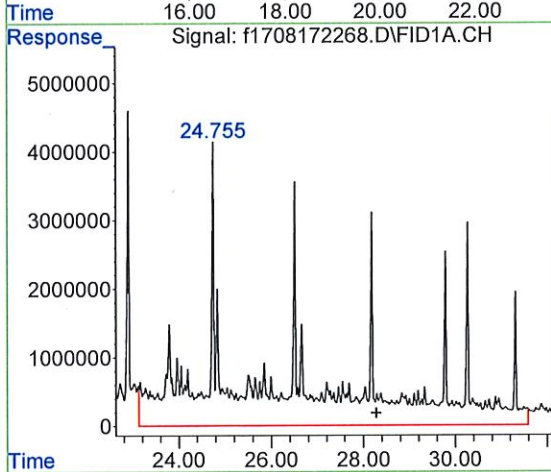

#7 > C16 to C21 Aliphatics

R.T.: 28.281 min  
 Delta R.T.: 0.000 min  
 Response: 2420916324  
 Conc: 1868.52 UG/ML m

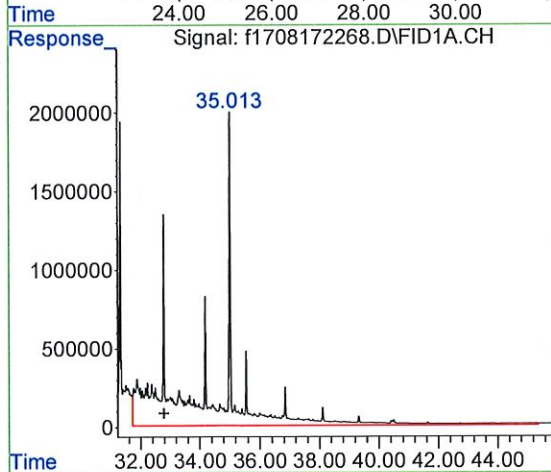

#8 > C21 to C32 Aliphatics

R.T.: 32.785 min  
 Delta R.T.: 0.000 min  
 Response: 505923626  
 Conc: 390.48 UG/ML m

Quantitation Report (QT Reviewed)

Data Path : C:\Projects\Hawaii DOH\2. Laboratory Data\Alpha\Carbon Range Study\L2240634\TPH\NF TPH\  
 Data File : f1708172270.D  
 Signal(s) : FID1A.CH  
 Acq On : 19 Aug 2022 15:24 pm  
 Operator : FID17:WR  
 Sample : L2240634-14,42,,  
 Misc : WG1676467,WG1676456,ICAL18753  
 ALS Vial : 35 Sample Multiplier: 1

Integration File: autoint1.e  
 Quant Time: Oct 22 17:25:54 2022  
 Quant Method : C:\Projects\Hawaii DOH\2. Laboratory Data\Alpha\Carbon Range Study\L2240634\TPH\NF TPH\  
 Quant Title : FID Forensics  
 QLast Update : Fri Sep 23 15:53:13 2022  
 Response via : Initial Calibration  
 Integrator: ChemStation 6890 Scale Mode: Large solvent peaks clipped

Volume Inj. :  
 Signal Phase :  
 Signal Info :

Compound	R.T.	Response	Conc Units
<b>Internal Standards</b>			
1) I 5-alpha-androstane	30.280	71347060	50.000 ug/mLm
<b>System Monitoring Compounds</b>			
3) s d50-Tetracosane	35.011	55068639	46.694 ug/mLm
Spiked Amount 50.000 Range 50 - 130 Recovery = 93.39%			
<b>Target Compounds</b>			
4) h > C8 to C10 Aliphatics	7.069	473685715	352.393 ug/mLm
5) h > C10 to C12 Aliphatics	11.972	918284796	683.147 ug/mlm
6) h > C12 to C16 Aliphatics	16.680	2947264608	2192.583 UG/MLm
7) h > C16 to C21 Aliphatics	28.281	3199675265	2380.361 UG/MLm
8) h > C21 to C32 Aliphatics	32.785	546954534	406.900 UG/MLm

SemiQuant Compounds - Not Calibrated on this Instrument

(f)=RT Delta > 1/2 Window (m)=manual int.

Quantitation Report (QT Reviewed)

Data Path : C:\Projects\Hawaii DOH\2. Laboratory Data\Alpha\Carbon Range Study\L2240634\TPH\NF TPH\  
Data File : f1708172270.D  
Signal(s) : FID1A.CH  
Acq On : 19 Aug 2022 15:24 pm  
Operator : FID17:WR  
Sample : L2240634-14,42,,  
Misc : WG1676467,WG1676456,ICAL18753  
ALS Vial : 35 Sample Multiplier: 1

Integration File: autoint1.e  
Quant Time: Oct 22 17:25:54 2022  
Quant Method : C:\Projects\Hawaii DOH\2. Laboratory Data\Alpha\Carbon Range Study\L2240634\TPH\NF TPH\NF TPH  
Quant Title : FID Forensics  
QLast Update : Fri Sep 23 15:53:13 2022  
Response via : Initial Calibration  
Integrator: ChemStation 6890 Scale Mode: Large solvent peaks clipped

Volume Inj. :  
Signal Phase :  
Signal Info :

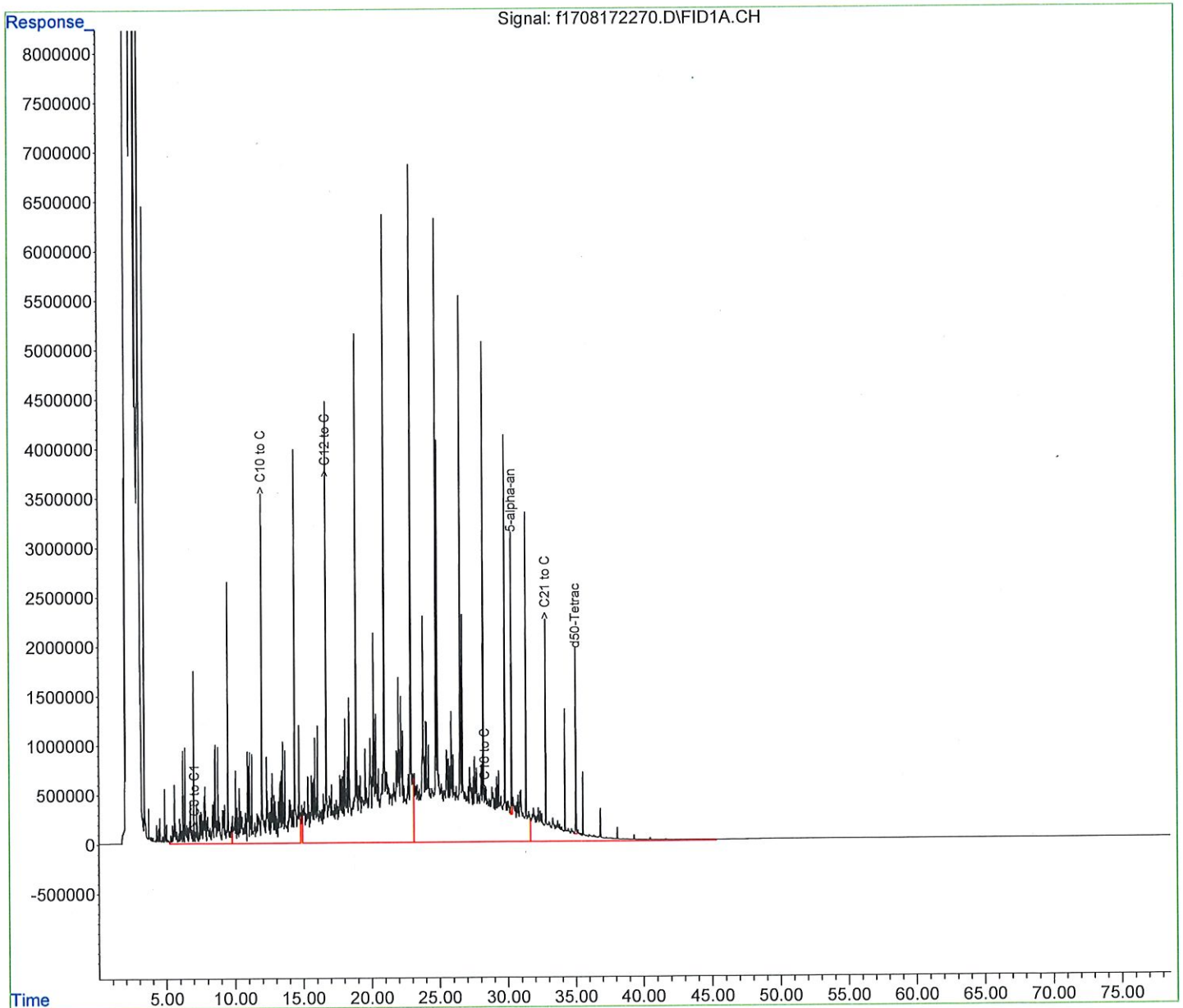

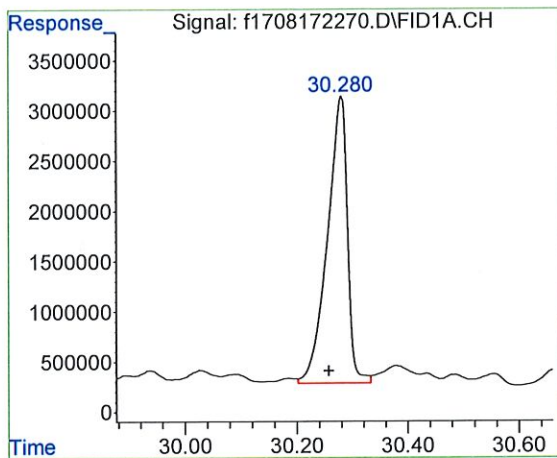

#1 5-alpha-androstane  
 R.T.: 30.280 min  
 Delta R.T.: 0.023 min  
 Response: 71347060  
 Conc: 50.00 ug/mL m

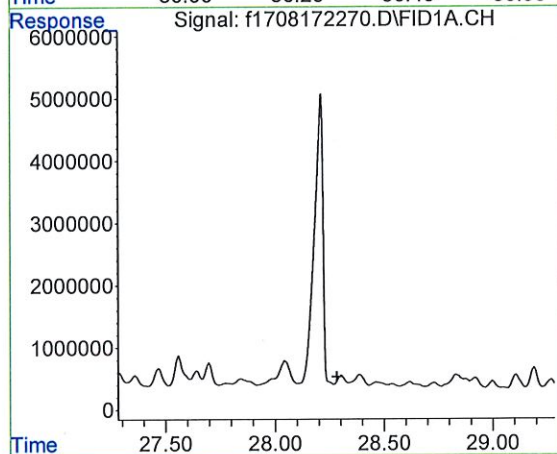

#2 ortho-terphenyl  
 R.T.: 0.000 min  
 Exp R.T. : 28.281 min  
 Response: 0  
 Conc: N.D.

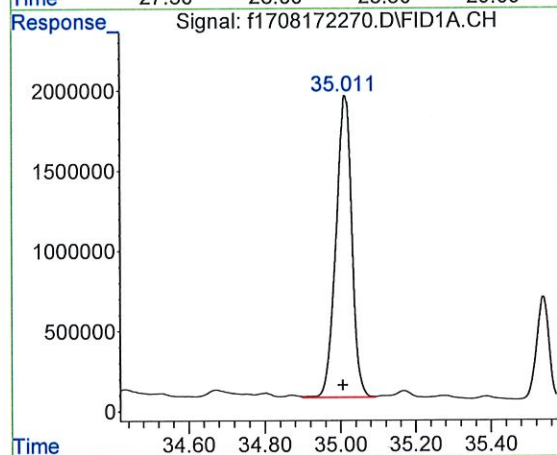

#3 d50-Tetracosane  
 R.T.: 35.011 min  
 Delta R.T.: 0.005 min  
 Response: 55068639  
 Conc: 46.69 ug/mL m

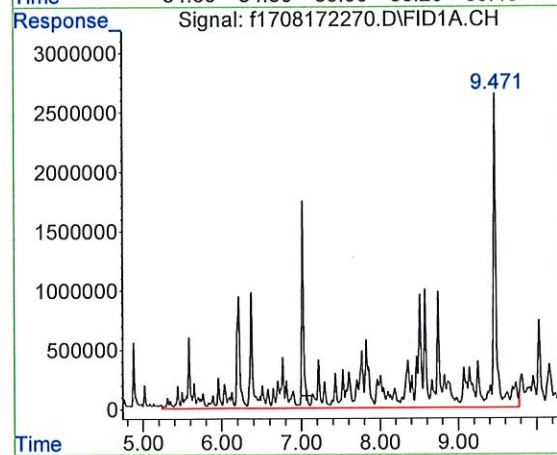

#4 > C8 to C10 Aliphatics  
 R.T.: 7.069 min  
 Delta R.T.: 0.000 min  
 Response: 473685715  
 Conc: 352.39 ug/mL m

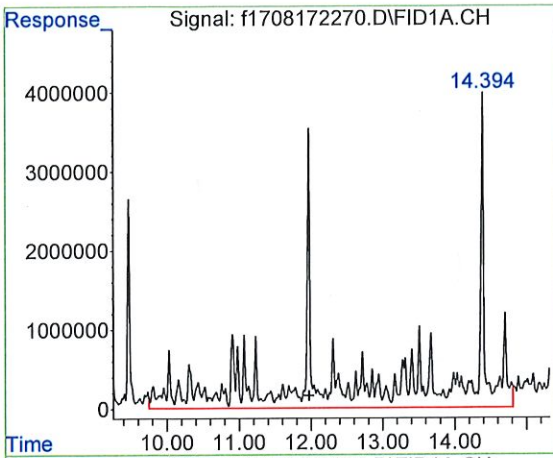

#5 > C10 to C12 Aliphatics

R.T.: 11.972 min  
 Delta R.T.: 0.000 min  
 Response: 918284796  
 Conc: 683.15 ug/ml m

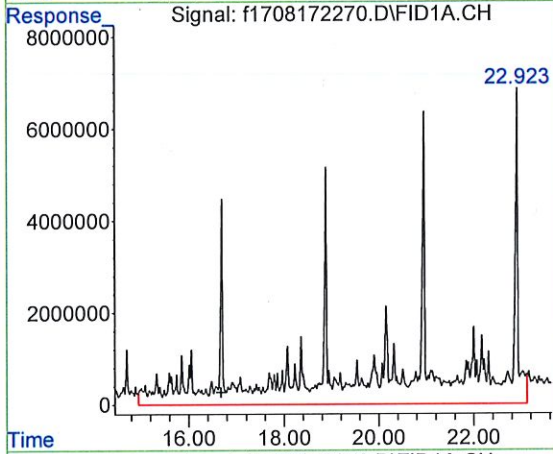

#6 > C12 to C16 Aliphatics

R.T.: 16.680 min  
 Delta R.T.: 0.000 min  
 Response: 2947264608  
 Conc: 2192.58 UG/ML m

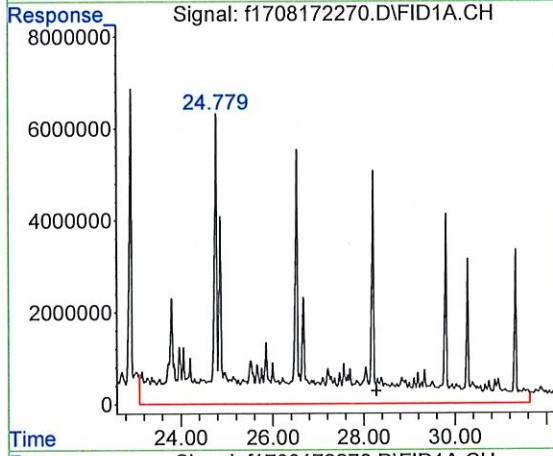

#7 > C16 to C21 Aliphatics

R.T.: 28.281 min  
 Delta R.T.: 0.000 min  
 Response: 3199675265  
 Conc: 2380.36 UG/ML m

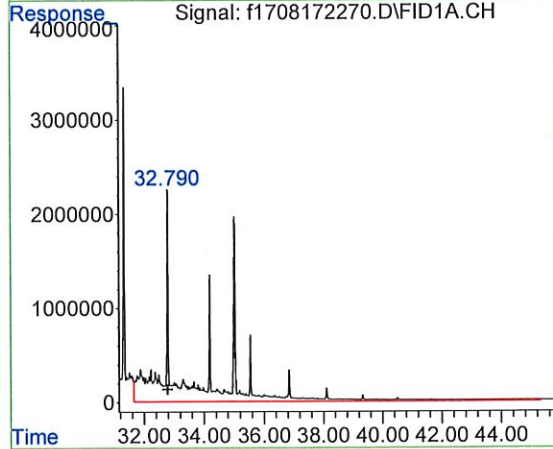

#8 > C21 to C32 Aliphatics

R.T.: 32.785 min  
 Delta R.T.: 0.000 min  
 Response: 546954534  
 Conc: 406.90 UG/ML m

Quantitation Report (QT Reviewed)

Data Path : C:\Projects\Hawaii DOH\2. Laboratory Data\Alpha\Carbon Range Study\L2240634\TPH\NF TPH\  
 Data File : f1708172278.D  
 Signal(s) : FID1A.CH  
 Acq On : 19 Aug 2022 21:29 pm  
 Operator : FID17:WR  
 Sample : L2240634-17,42,,  
 Misc : WG1676467,WG1676456,ICAL18753  
 ALS Vial : 39 Sample Multiplier: 1

Integration File: autoint1.e  
 Quant Time: Oct 22 17:45:02 2022  
 Quant Method : C:\Projects\Hawaii DOH\2. Laboratory Data\Alpha\Carbon Range Study\L2240634\TPH\NF TPH\NF TPH\  
 Quant Title : FID Forensics  
 QLast Update : Fri Sep 23 15:53:13 2022  
 Response via : Initial Calibration  
 Integrator: ChemStation 6890 Scale Mode: Large solvent peaks clipped

Volume Inj. :  
 Signal Phase :  
 Signal Info :

Compound	R.T.	Response	Conc Units
Internal Standards			
1) I 5-alpha-androstane	30.250	66264060	50.000 ug/mLm
System Monitoring Compounds			
3) s d50-Tetracosane	35.008	51828863	47.318 ug/mLm
Spiked Amount 50.000 Range 50 - 130 Recovery = 94.64%			
Target Compounds			
4) h > C8 to C10 Aliphatics	7.069	1510386093	1209.826 ug/mLm
5) h > C10 to C12 Aliphatics	11.972	6956599866	5572.267 ug/mlm
6) h > C12 to C16 Aliphatics	16.680	7882540532	6313.949 UG/MLm
7) h > C16 to C21 Aliphatics	28.281	57722154	46.236 UG/MLm
8) h > C21 to C32 Aliphatics	32.785	23221356	18.600 UG/MLm

SemiQuant Compounds - Not Calibrated on this Instrument

(f)=RT Delta > 1/2 Window (m)=manual int.

Quantitation Report (QT Reviewed)

Data Path : C:\Projects\Hawaii DOH\2. Laboratory Data\Alpha\Carbon Range Study\L2240634\TPH\NF TPH\  
Data File : f1708172278.D  
Signal(s) : FID1A.CH  
Acq On : 19 Aug 2022 21:29 pm  
Operator : FID17:WR  
Sample : L2240634-17,42,,  
Misc : WG1676467,WG1676456,ICAL18753  
ALS Vial : 39 Sample Multiplier: 1

Integration File: autoint1.e  
Quant Time: Oct 22 17:45:02 2022  
Quant Method : C:\Projects\Hawaii DOH\2. Laboratory Data\Alpha\Carbon Range Study\L2240634\TPH\NF TPH\  
Quant Title : FID Forensics  
QLast Update : Fri Sep 23 15:53:13 2022  
Response via : Initial Calibration  
Integrator: ChemStation 6890 Scale Mode: Large solvent peaks clipped

Volume Inj. :  
Signal Phase :  
Signal Info :

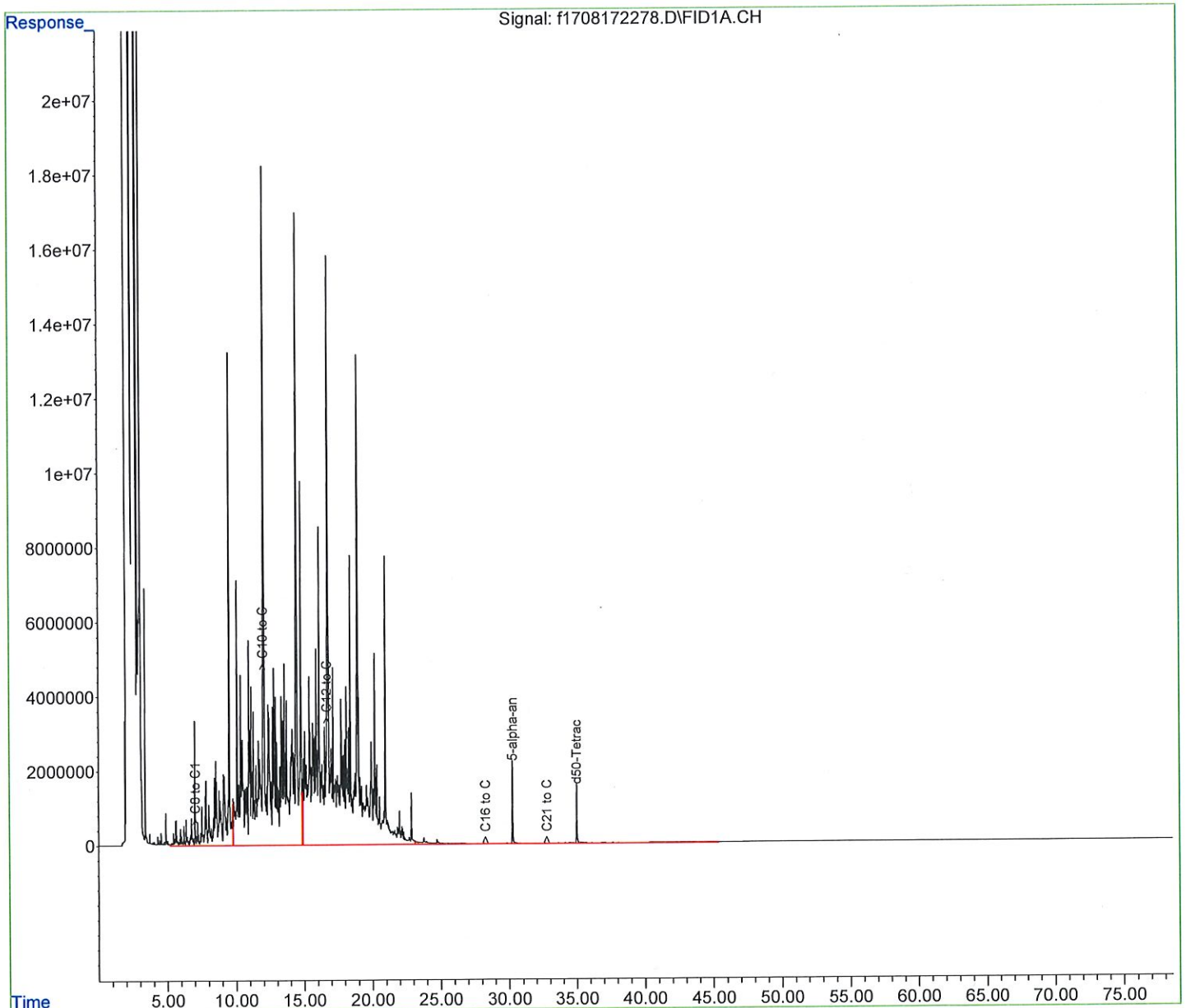



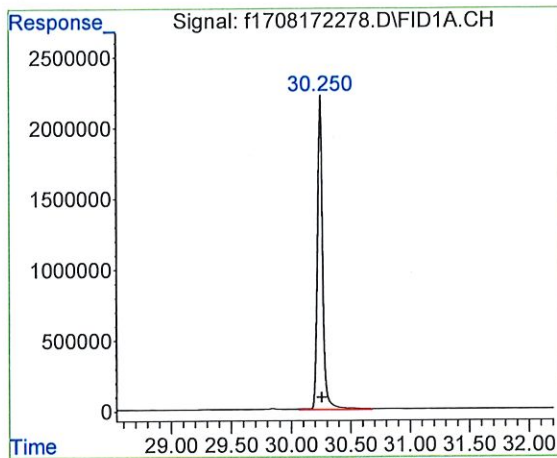

#1 5-alpha-androstane  
 R.T.: 30.250 min  
 Delta R.T.: -0.007 min  
 Response: 66264060  
 Conc: 50.00 ug/mL m

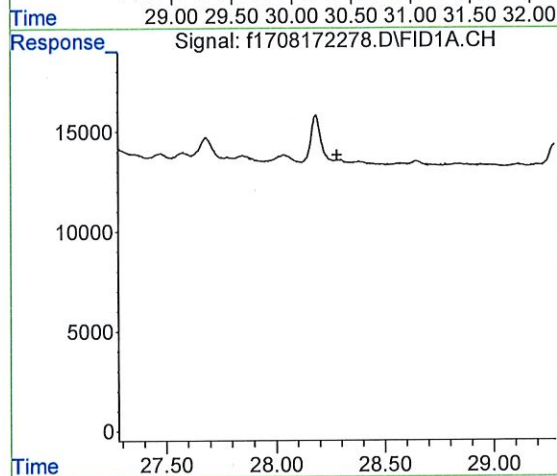

#2 ortho-terphenyl  
 R.T.: 0.000 min  
 Exp R.T. : 28.281 min  
 Response: 0  
 Conc: N.D.

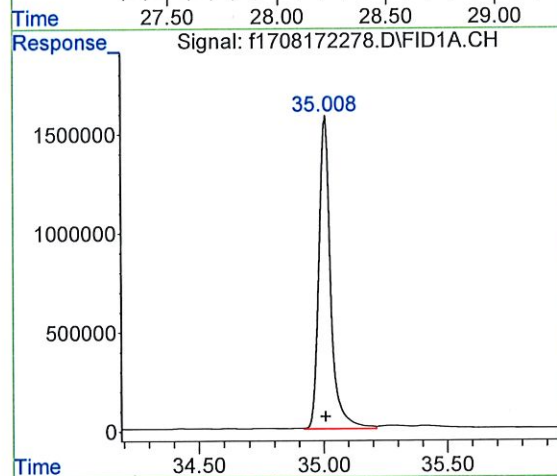

#3 d50-Tetracosane  
 R.T.: 35.008 min  
 Delta R.T.: 0.001 min  
 Response: 51828863  
 Conc: 47.32 ug/mL m

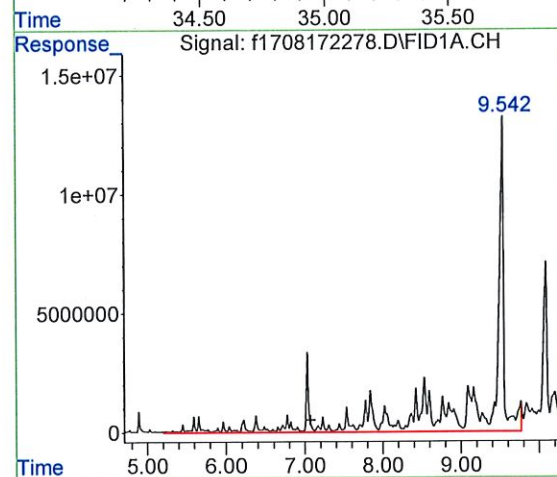

#4 > C8 to C10 Aliphatics  
 R.T.: 7.069 min  
 Delta R.T.: 0.000 min  
 Response: 1510386093  
 Conc: 1209.83 ug/mL m

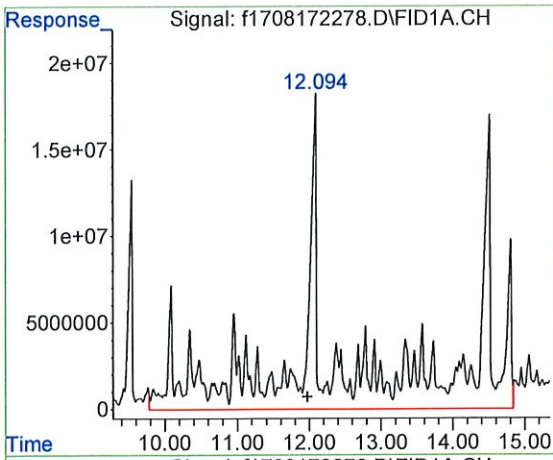

#5 > C10 to C12 Aliphatics

R.T.: 11.972 min  
 Delta R.T.: 0.000 min  
 Response: 6956599866  
 Conc: 5572.27 ug/ml m

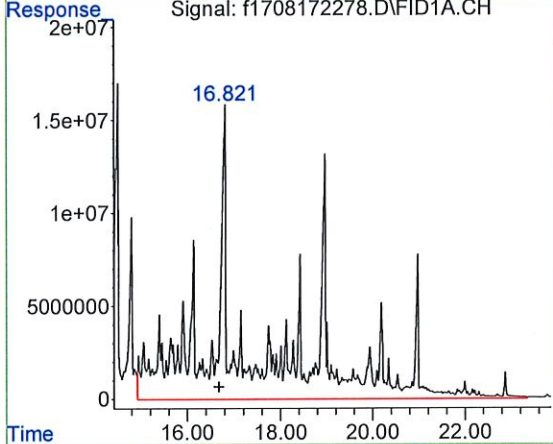

#6 > C12 to C16 Aliphatics

R.T.: 16.680 min  
 Delta R.T.: 0.000 min  
 Response: 7882540532  
 Conc: 6313.95 UG/ML m

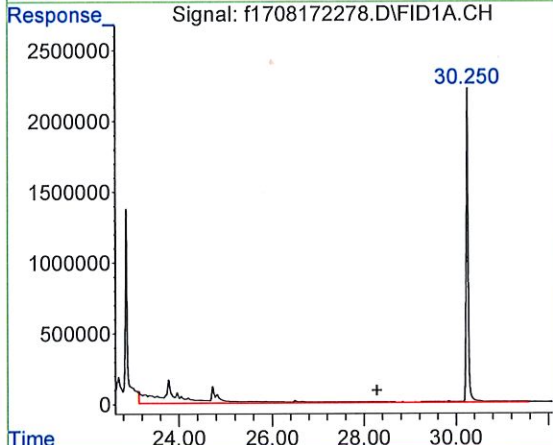

#7 > C16 to C21 Aliphatics

R.T.: 28.281 min  
 Delta R.T.: 0.000 min  
 Response: 57722154  
 Conc: 46.24 UG/ML m

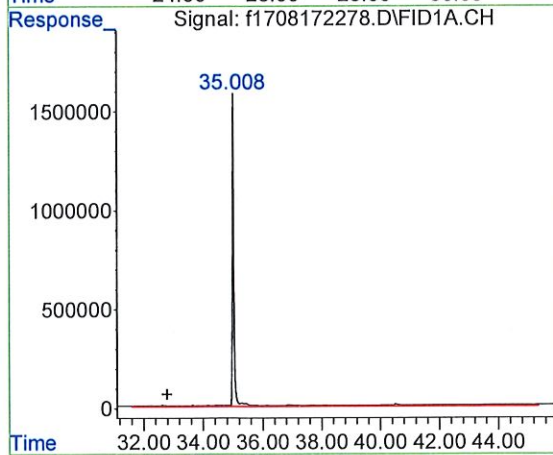

#8 > C21 to C32 Aliphatics

R.T.: 32.785 min  
 Delta R.T.: 0.000 min  
 Response: 23221356  
 Conc: 18.60 UG/ML m

Quantitation Report (QT Reviewed)

Data Path : C:\Projects\Hawaii DOH\2. Laboratory Data\Alpha\Carbon Range Study\L2240634\TPH\NF TPH\  
Data File : f1708172280.D  
Signal(s) : FID1A.CH  
Acq On : 19 Aug 2022 23:00 pm  
Operator : FID17:WR  
Sample : L2240634-20,42,,  
Misc : WG1676467,WG1676456,ICAL18753  
ALS Vial : 40 Sample Multiplier: 1

Integration File: autoint1.e  
Quant Time: Oct 22 17:53:55 2022  
Quant Method : C:\Projects\Hawaii DOH\2. Laboratory Data\Alpha\Carbon Range Study\L2240634\TPH\NF TPH\NF TPH ( )  
Quant Title : FID Forensics  
QLast Update : Fri Sep 23 15:53:13 2022  
Response via : Initial Calibration  
Integrator: ChemStation 6890 Scale Mode: Large solvent peaks clipped

Volume Inj. :  
Signal Phase :  
Signal Info :

Compound	R.T.	Response	Conc Units
Internal Standards			
1) I 5-alpha-androstane	30.250	61578399	50.000 ug/mLm
System Monitoring Compounds			
3) s d50-Tetracosane	35.005	48822991	47.966 ug/mLm
Spiked Amount	50.000	Range 50 - 130	Recovery = 95.93%
Target Compounds			
4) h > C8 to C10 Aliphatics	7.069	3516785025	3031.310 ug/mLm
5) h > C10 to C12 Aliphatics	11.972	4186414087	3608.500 ug/mlm
6) h > C12 to C16 Aliphatics	16.680	5446394917	4694.547 UG/MLm
7) h > C16 to C21 Aliphatics	28.281	483664196	416.897 UG/MLm
8) h > C21 to C32 Aliphatics	32.785	26062216	22.464 UG/MLm

SemiQuant Compounds - Not Calibrated on this Instrument

(f)=RT Delta > 1/2 Window

(m)=manual int.

Quantitation Report (QT Reviewed)

Data Path : C:\Projects\Hawaii DOH\2. Laboratory Data\Alpha\Carbon Range Study\L2240634\TPH\NF TPH\  
Data File : f1708172280.D  
Signal(s) : FID1A.CH  
Acq On : 19 Aug 2022 23:00 pm  
Operator : FID17:WR  
Sample : L2240634-20,42,,  
Misc : WG1676467,WG1676456,ICAL18753  
ALS Vial : 40 Sample Multiplier: 1

Integration File: autoint1.e  
Quant Time: Oct 22 17:53:55 2022  
Quant Method : C:\Projects\Hawaii DOH\2. Laboratory Data\Alpha\Carbon Range Study\L2240634\TPH\NF TPH\NF TPH  
Quant Title : FID Forensics  
QLast Update : Fri Sep 23 15:53:13 2022  
Response via : Initial Calibration  
Integrator: ChemStation 6890 Scale Mode: Large solvent peaks clipped

Volume Inj. :  
Signal Phase :  
Signal Info :

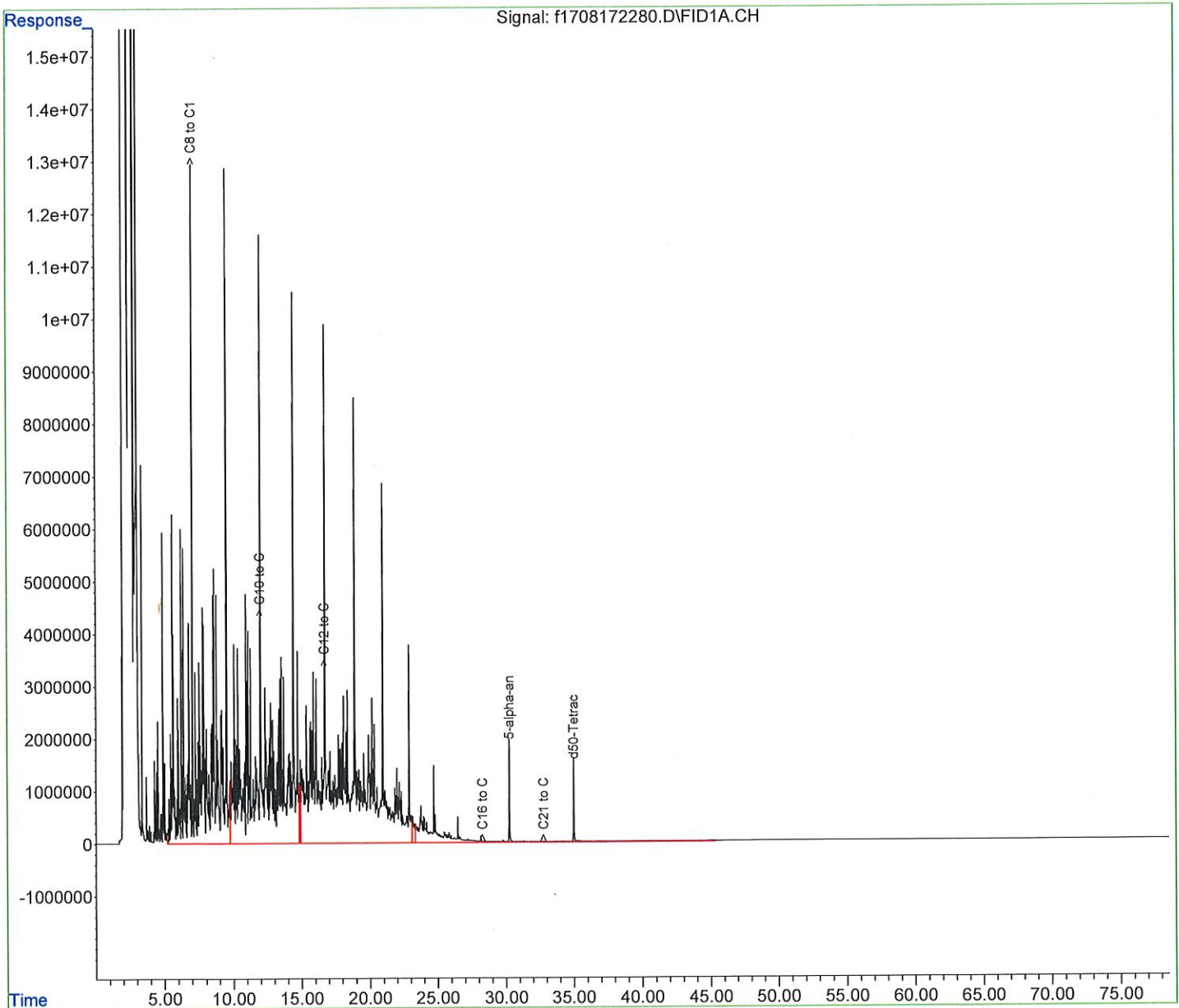

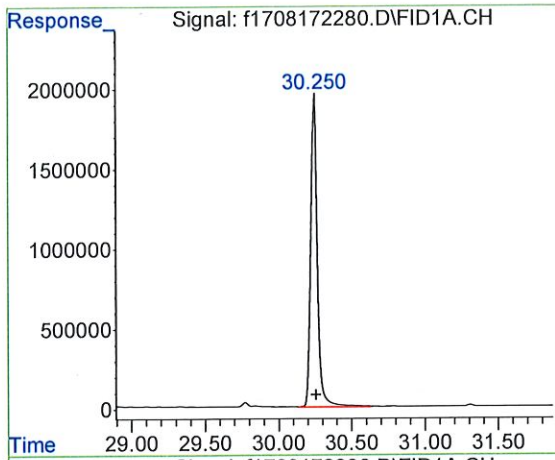

#1 5-alpha-androstane  
 R.T.: 30.250 min  
 Delta R.T.: -0.006 min  
 Response: 61578399  
 Conc: 50.00 ug/mL m

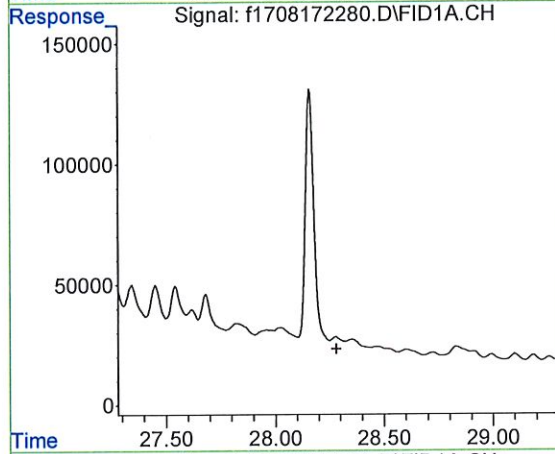

#2 ortho-terphenyl  
 R.T.: 0.000 min  
 Exp R.T. : 28.281 min  
 Response: 0  
 Conc: N.D.

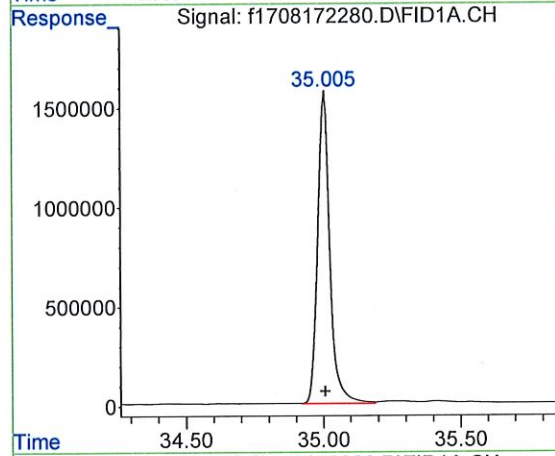

#3 d50-Tetracosane  
 R.T.: 35.005 min  
 Delta R.T.: -0.002 min  
 Response: 48822991  
 Conc: 47.97 ug/mL m

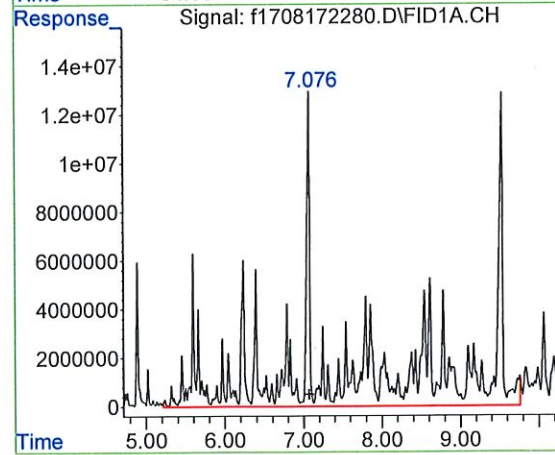

#4 > C8 to C10 Aliphatics  
 R.T.: 7.069 min  
 Delta R.T.: 0.000 min  
 Response: 3516785025  
 Conc: 3031.31 ug/mL m

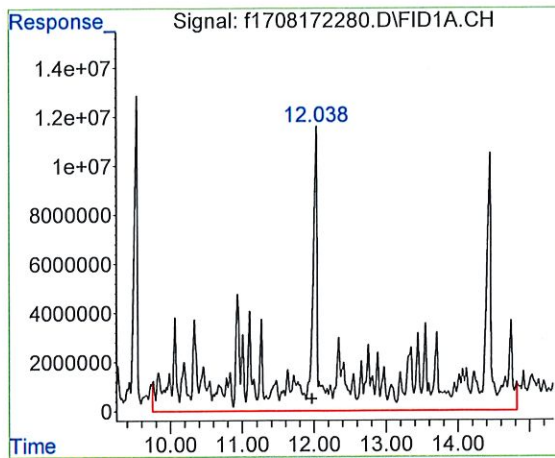

#5 > C10 to C12 Aliphatics

R.T.: 11.972 min  
 Delta R.T.: 0.000 min  
 Response: 4186414087  
 Conc: 3608.50 ug/ml m

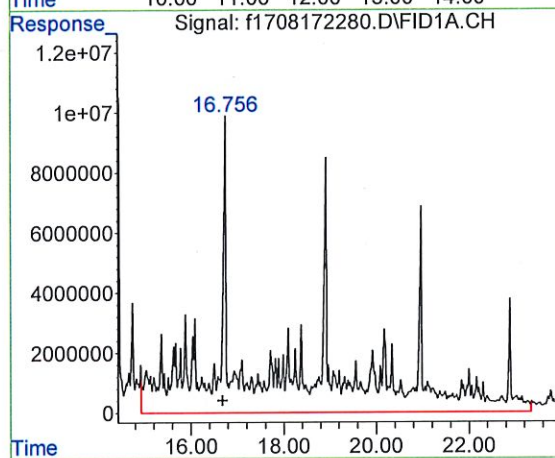

#6 > C12 to C16 Aliphatics

R.T.: 16.680 min  
 Delta R.T.: 0.000 min  
 Response: 5446394917  
 Conc: 4694.55 UG/ML m

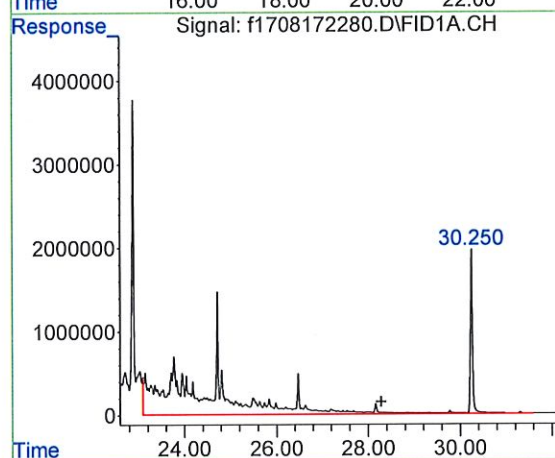

#7 > C16 to C21 Aliphatics

R.T.: 28.281 min  
 Delta R.T.: 0.000 min  
 Response: 483664196  
 Conc: 416.90 UG/ML m

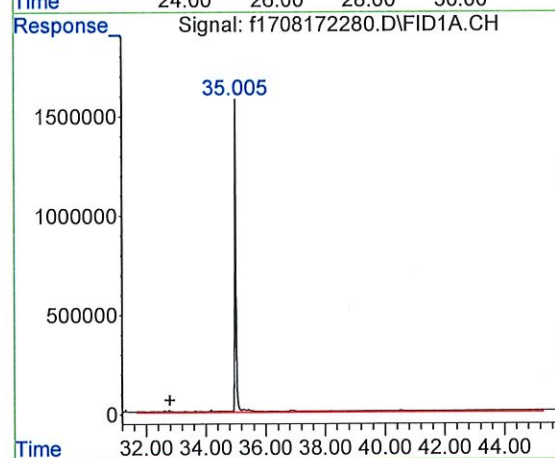

#8 > C21 to C32 Aliphatics

R.T.: 32.785 min  
 Delta R.T.: 0.000 min  
 Response: 26062216  
 Conc: 22.46 UG/ML m

Quantitation Report (QT Reviewed)

Data Path : C:\Projects\Hawaii DOH\2. Laboratory Data\Alpha\Carbon Range Study\L2240634\TPH\NF TPH\  
 Data File : f1708172284.D  
 Signal(s) : FID1A.CH  
 Acq On : 20 Aug 2022 2:01 am  
 Operator : FID17:WR  
 Sample : L2240634-26,42,,  
 Misc : WG1676467,WG1676456,ICAL18753  
 ALS Vial : 42 Sample Multiplier: 1

Integration File: autoint1.e  
 Quant Time: Oct 22 18:04:39 2022  
 Quant Method : C:\Projects\Hawaii DOH\2. Laboratory Data\Alpha\Carbon Range Study\L2240634\TPH\NF TPH\NF TPH (   
 Quant Title : FID Forensics  
 QLast Update : Fri Sep 23 15:53:13 2022  
 Response via : Initial Calibration  
 Integrator: ChemStation 6890 Scale Mode: Large solvent peaks clipped

Volume Inj. :  
 Signal Phase :  
 Signal Info :

Compound	R.T.	Response	Conc Units
Internal Standards			
1) I 5-alpha-androstane	30.261	82004497	50.000 ug/mLm
System Monitoring Compounds			
3) s d50-Tetracosane	35.017	67152910	49.541 ug/mLm
Spiked Amount 50.000 Range 50 - 130 Recovery = 99.08%			
Target Compounds			
4) h > C8 to C10 Aliphatics	7.069	32202572	20.843 ug/mLm
5) h > C10 to C12 Aliphatics	11.972	227632553	147.336 ug/mlm
6) h > C12 to C16 Aliphatics	16.680	817697244	529.258 UG/MLm
7) h > C16 to C21 Aliphatics	28.281	1095318580	708.950 UG/MLm
8) h > C21 to C32 Aliphatics	32.785	2940194047	1903.055 UG/MLm

SemiQuant Compounds - Not Calibrated on this Instrument

(f)=RT Delta > 1/2 Window (m)=manual int.

Quantitation Report (QT Reviewed)

Data Path : C:\Projects\Hawaii DOH\2. Laboratory Data\Alpha\Carbon Range Study\L2240634\TPH\NF TPH\  
Data File : f1708172284.D  
Signal(s) : FID1A.CH  
Acq On : 20 Aug 2022 2:01 am  
Operator : FID17:WR  
Sample : L2240634-26,42,,  
Misc : WG1676467,WG1676456,ICAL18753  
ALS Vial : 42 Sample Multiplier: 1

Integration File: autoint1.e  
Quant Time: Oct 22 18:04:39 2022  
Quant Method : C:\Projects\Hawaii DOH\2. Laboratory Data\Alpha\Carbon Range Study\L2240634\TPH\NF TPH\NF TPH  
Quant Title : FID Forensics  
QLast Update : Fri Sep 23 15:53:13 2022  
Response via : Initial Calibration  
Integrator: ChemStation 6890 Scale Mode: Large solvent peaks clipped

Volume Inj. :  
Signal Phase :  
Signal Info :

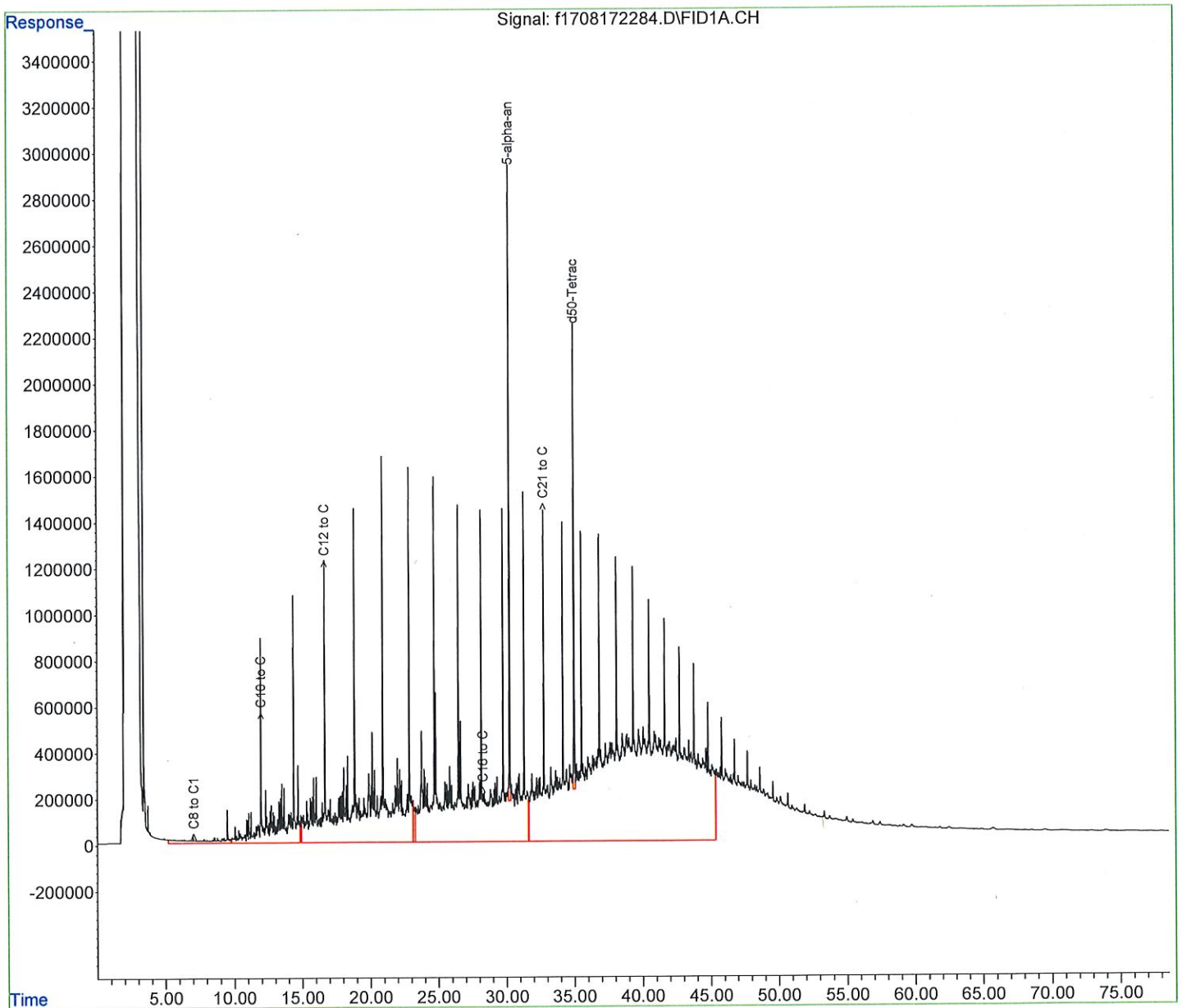



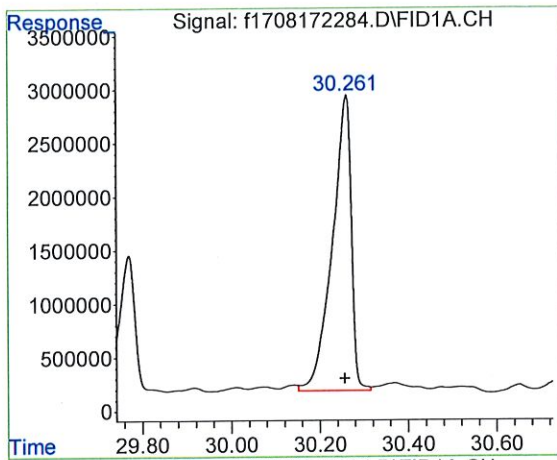

#1 5-alpha-androstane  
 R.T.: 30.261 min  
 Delta R.T.: 0.005 min  
 Response: 82004497  
 Conc: 50.00 ug/mL m

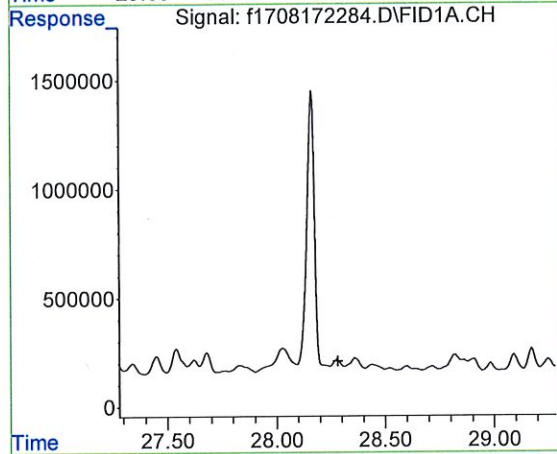

#2 ortho-terphenyl  
 R.T.: 0.000 min  
 Exp R.T. : 28.281 min  
 Response: 0  
 Conc: N.D.

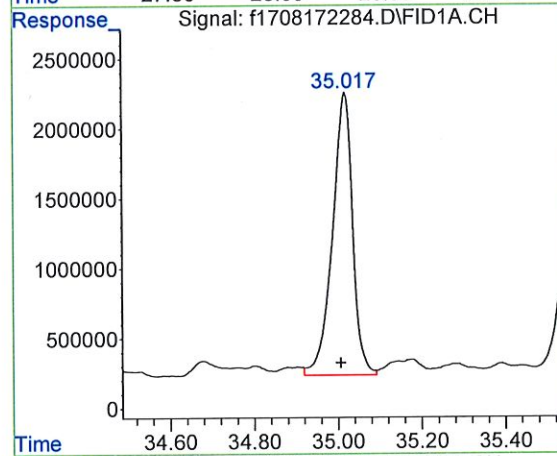

#3 d50-Tetracosane  
 R.T.: 35.017 min  
 Delta R.T.: 0.011 min  
 Response: 67152910  
 Conc: 49.54 ug/mL m

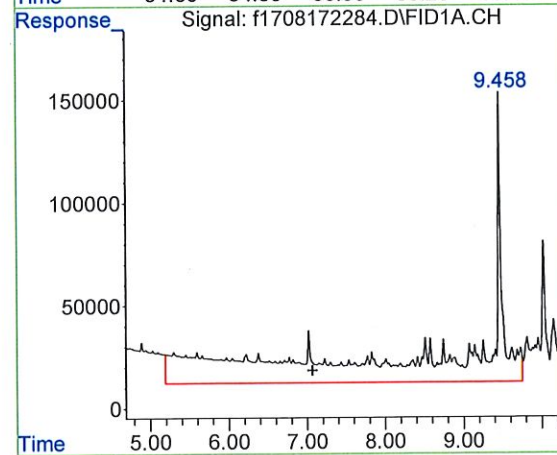

#4 > C8 to C10 Aliphatics  
 R.T.: 7.069 min  
 Delta R.T.: 0.000 min  
 Response: 32202572  
 Conc: 20.84 ug/mL m

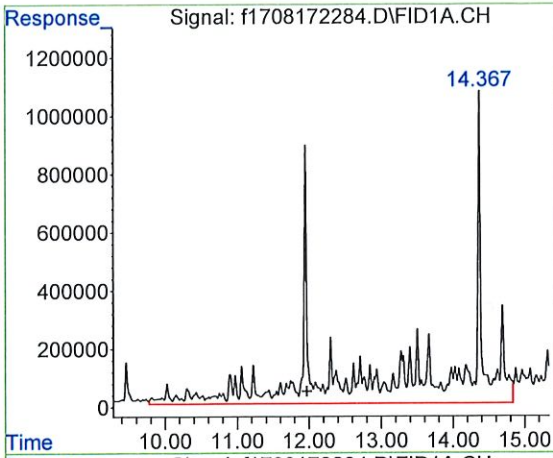

#5 > C10 to C12 Aliphatics

R.T.: 11.972 min  
 Delta R.T.: 0.000 min  
 Response: 227632553  
 Conc: 147.34 ug/ml m

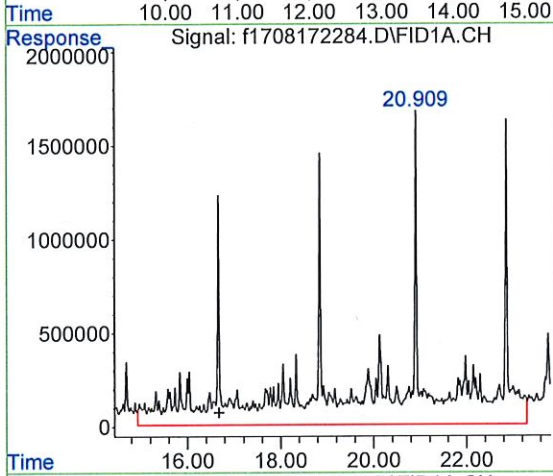

#6 > C12 to C16 Aliphatics

R.T.: 16.680 min  
 Delta R.T.: 0.000 min  
 Response: 817697244  
 Conc: 529.26 UG/ML m

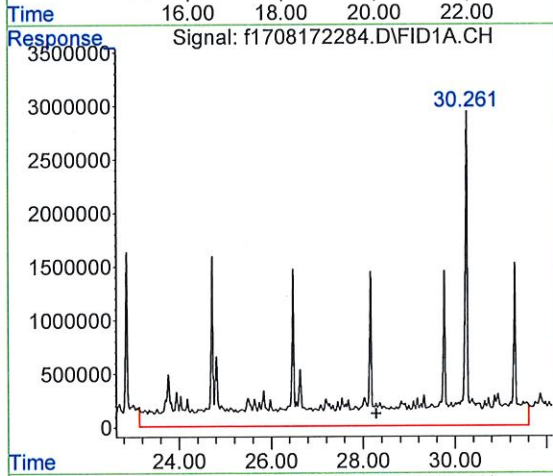

#7 > C16 to C21 Aliphatics

R.T.: 28.281 min  
 Delta R.T.: 0.000 min  
 Response: 1095318580  
 Conc: 708.95 UG/ML m

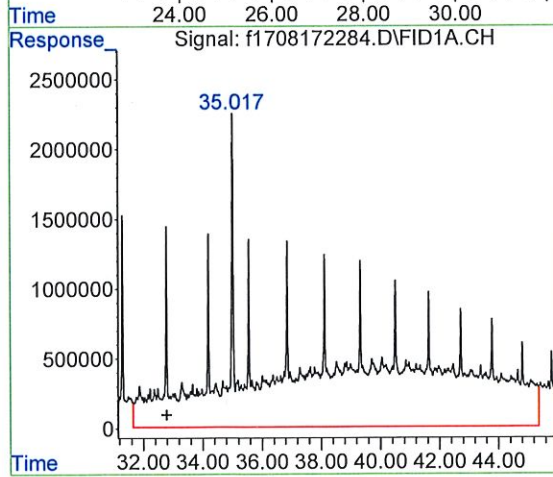

#8 > C21 to C32 Aliphatics

R.T.: 32.785 min  
 Delta R.T.: 0.000 min  
 Response: 2940194047  
 Conc: 1903.05 UG/ML m

Quantitation Report (QT Reviewed)

Data Path : C:\Projects\Hawaii DOH\2. Laboratory Data\Alpha\Carbon Range Study\L2240634\TPH\NF TPH\  
 Data File : f1709062244.D  
 Signal(s) : FID1A.CH  
 Acq On : 07 Sep 2022 22:05 pm  
 Operator : FID17:WR  
 Sample : I2240634-33,42,,  
 Misc : WG1684077,WG1682989,ICAL18753  
 ALS Vial : 22 Sample Multiplier: 1

Integration File: autoint1.e  
 Quant Time: Oct 22 18:31:24 2022  
 Quant Method : C:\Projects\Hawaii DOH\2. Laboratory Data\Alpha\Carbon Range Study\L2240634\TPH\NF TPH\NF TPH (   
 Quant Title : FID Forensics  
 QLast Update : Fri Sep 23 15:53:13 2022  
 Response via : Initial Calibration  
 Integrator: ChemStation 6890 Scale Mode: Large solvent peaks clipped

Volume Inj. :  
 Signal Phase :  
 Signal Info :

Compound	R.T.	Response	Conc Units
Internal Standards			
1) I 5-alpha-androstane	30.077	60427121	50.000 ug/mLm
System Monitoring Compounds			
3) s d50-Tetracosane	34.875	56293433	56.359 ug/mLm
Spiked Amount 50.000 Range 50 - 130 Recovery = 112.72%			
Target Compounds			
4) h > C8 to C10 Aliphatics	7.042	11334302	9.956 ug/mLm
5) h > C10 to C12 Aliphatics	11.919	11462659	10.069 ug/mlm
6) h > C12 to C16 Aliphatics	16.606	24386921	21.421 UG/MLm
7) h > C16 to C21 Aliphatics	28.155	121462692	106.690 UG/MLm
8) h > C21 to C32 Aliphatics	32.639	8327772379	7314.925 UG/MLm

SemiQuant Compounds - Not Calibrated on this Instrument

(f)=RT Delta > 1/2 Window (m)=manual int.

Quantitation Report (QT Reviewed)

Data Path : C:\Projects\Hawaii DOH\2. Laboratory Data\Alpha\Carbon Range Study\L2240634\TPH\NF TPH\  
Data File : f1709062244.D  
Signal(s) : FID1A.CH  
Acq On : 07 Sep 2022 22:05 pm  
Operator : FID17:WR  
Sample : I2240634-33,42,,  
Misc : WG1684077,WG1682989,ICAL18753  
ALS Vial : 22 Sample Multiplier: 1

Integration File: autoint1.e  
Quant Time: Oct 22 18:31:24 2022  
Quant Method : C:\Projects\Hawaii DOH\2. Laboratory Data\Alpha\Carbon Range Study\L2240634\TPH\NF TPH\  
Quant Title : FID Forensics  
QLast Update : Fri Sep 23 15:53:13 2022  
Response via : Initial Calibration  
Integrator: ChemStation 6890 Scale Mode: Large solvent peaks clipped

Volume Inj. :  
Signal Phase :  
Signal Info :

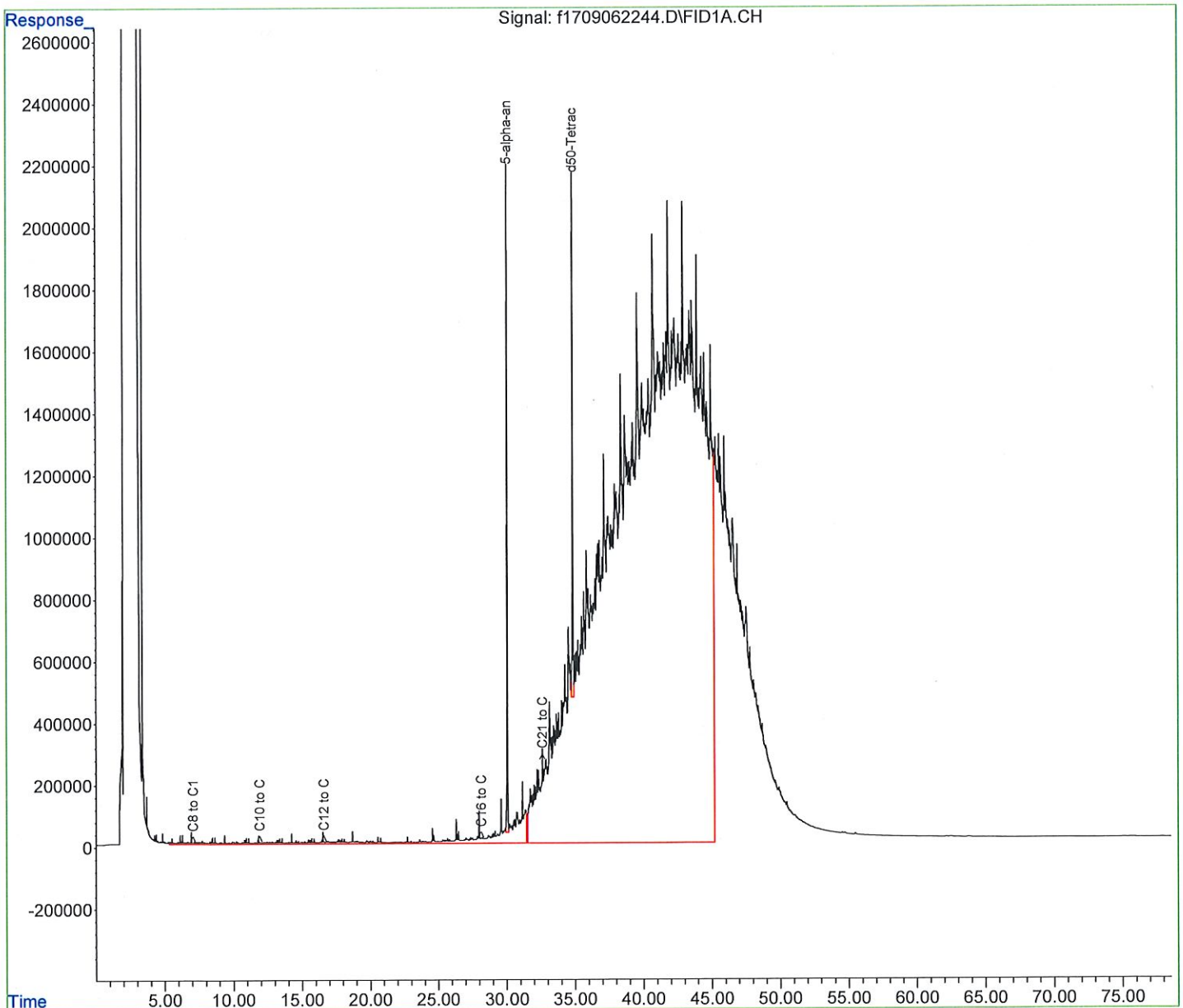

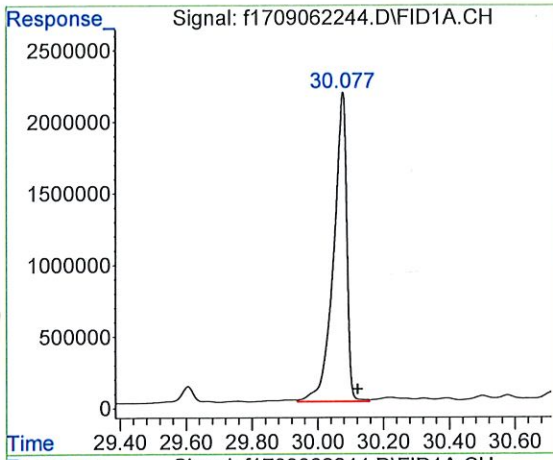

#1 5-alpha-androstane  
 R.T.: 30.077 min  
 Delta R.T.: -0.045 min  
 Response: 60427121  
 Conc: 50.00 ug/mL m

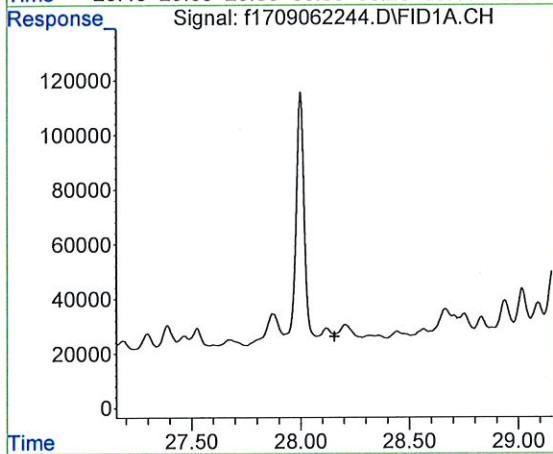

#2 ortho-terphenyl  
 R.T.: 0.000 min  
 Exp R.T. : 28.155 min  
 Response: 0  
 Conc: N.D.

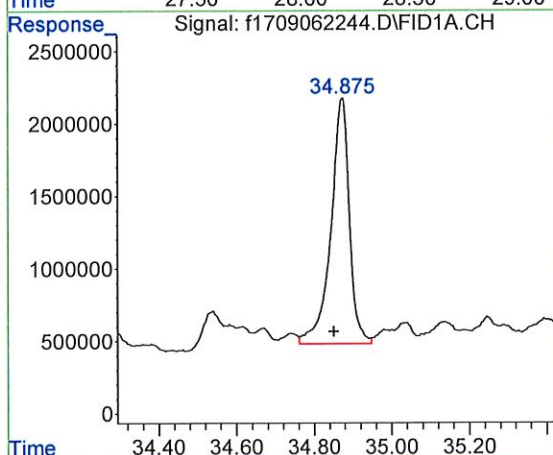

#3 d50-Tetracosane  
 R.T.: 34.875 min  
 Delta R.T.: 0.024 min  
 Response: 56293433  
 Conc: 56.36 ug/mL m

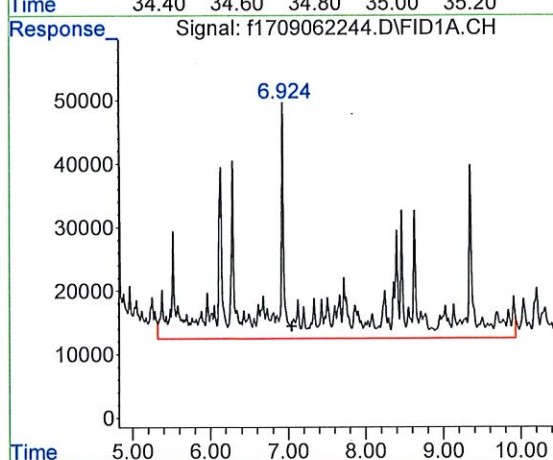

#4 > C8 to C10 Aliphatics  
 R.T.: 7.042 min  
 Delta R.T.: 0.000 min  
 Response: 11334302  
 Conc: 9.96 ug/mL m

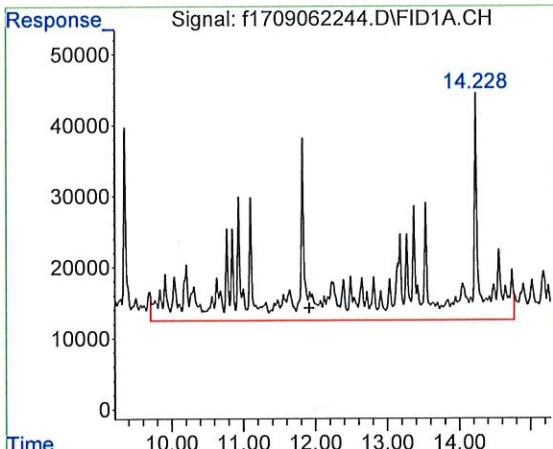

#5 > C10 to C12 Aliphatics

R.T.: 11.919 min  
 Delta R.T.: 0.000 min  
 Response: 11462659  
 Conc: 10.07 ug/ml m

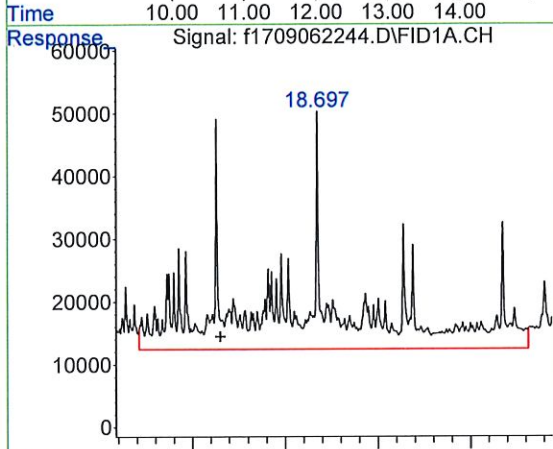

#6 > C12 to C16 Aliphatics

R.T.: 16.606 min  
 Delta R.T.: 0.000 min  
 Response: 24386921  
 Conc: 21.42 UG/ML m

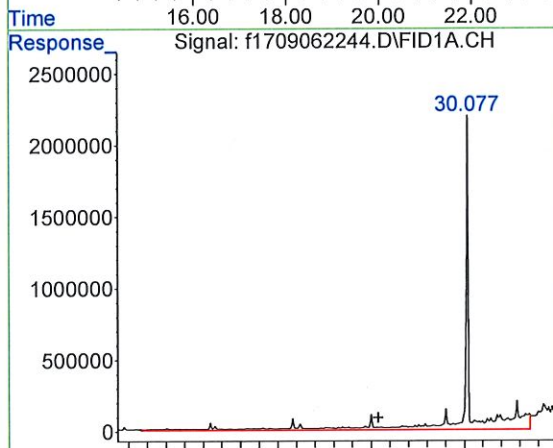

#7 > C16 to C21 Aliphatics

R.T.: 28.155 min  
 Delta R.T.: 0.000 min  
 Response: 121462692  
 Conc: 106.69 UG/ML m

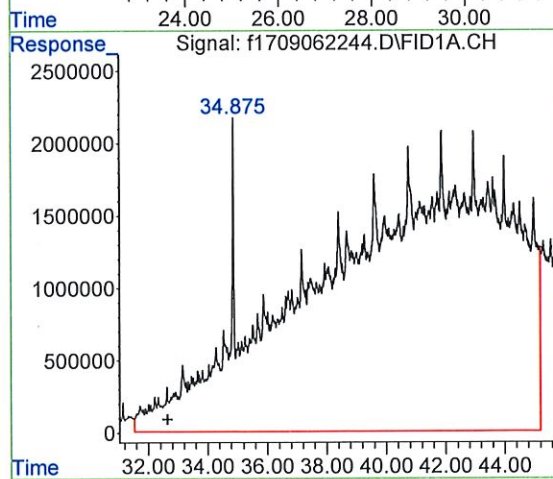

#8 > C21 to C32 Aliphatics

R.T.: 32.639 min  
 Delta R.T.: 0.000 min  
 Response: 8327772379  
 Conc: 7314.92 UG/ML m

Quantitation Report (QT Reviewed)

Data Path : C:\Projects\Hawaii DOH\2. Laboratory Data\Alpha\Carbon Range Study\L2240634\TPH\NF TPH\  
 Data File : f1708242212.D  
 Signal(s) : FID1A.CH  
 Acq On : 25 Aug 2022 9:53 am  
 Operator : FID17:WR  
 Sample : WG1676458-1,42,,  
 Misc : WG1679263,WG1676458,ICAL18753  
 ALS Vial : 6 Sample Multiplier: 1

Integration File: autoint1.e  
 Quant Time: Oct 22 18:54:38 2022  
 Quant Method : C:\Projects\Hawaii DOH\2. Laboratory Data\Alpha\Carbon Range Study\L2240634\TPH\NF TPH\NF TPH (   
 Quant Title : FID Forensics  
 QLast Update : Fri Sep 23 15:53:13 2022  
 Response via : Initial Calibration  
 Integrator: ChemStation 6890 Scale Mode: Large solvent peaks clipped

Volume Inj. :  
 Signal Phase :  
 Signal Info :

Compound	R.T.	Response	Conc Units
----------	------	----------	------------

Internal Standards

1) I 5-alpha-androstane	30.131	64228646	50.000 ug/mLm
-------------------------	--------	----------	---------------

System Monitoring Compounds

2) s ortho-terphenyl	28.163	62124248	46.267 ug/mLm
Spiked Amount	50.000	Range 50 - 130	Recovery = 92.53%

Target Compounds

4) h > C8 to C10 Aliphatics	7.043	6387733	5.279 ug/mLm
5) h > C10 to C12 Aliphatics	11.928	8442061	6.976 ug/mlm
6) h > C12 to C16 Aliphatics	16.619	21575818	17.830 UG/MLm
7) h > C16 to C21 Aliphatics	28.177	22492390	18.587 UG/MLm
8) h > C21 to C32 Aliphatics	32.664	57886459	47.837 UG/MLm
9) h > C8 to C10 Aromatics	7.043	6301191	5.207 UG/MLm
10) h > C10 to C12 Aromatics	11.928	8032661	6.638 UG/MLm
11) h > C12 to C16 Aromatics	16.619	21433732	17.713 UG/MLm
12) h > C16 to C21 Aromatics	28.177	22711550	18.769 UG/MLm
13) h > C21 to C32 Aromatics	32.664	58236843	48.126 UG/MLm

SemiQuant Compounds - Not Calibrated on this Instrument

(f)=RT Delta > 1/2 Window

(m)=manual int.

Quantitation Report (QT Reviewed)

Data Path : C:\Projects\Hawaii DOH\2. Laboratory Data\Alpha\Carbon Range Study\L2240634\TPH\NF TPH\  
Data File : f1708242212.D  
Signal(s) : FID1A.CH  
Acq On : 25 Aug 2022 9:53 am  
Operator : FID17:WR  
Sample : WG1676458-1,42,,  
Misc : WG1679263,WG1676458,ICAL18753  
ALS Vial : 6 Sample Multiplier: 1

Integration File: autoint1.e  
Quant Time: Oct 22 18:54:38 2022  
Quant Method : C:\Projects\Hawaii DOH\2. Laboratory Data\Alpha\Carbon Range Study\L2240634\TPH\NF TPH\  
Quant Title : FID Forensics  
QLast Update : Fri Sep 23 15:53:13 2022  
Response via : Initial Calibration  
Integrator: ChemStation 6890 Scale Mode: Large solvent peaks clipped

Volume Inj. :  
Signal Phase :  
Signal Info :

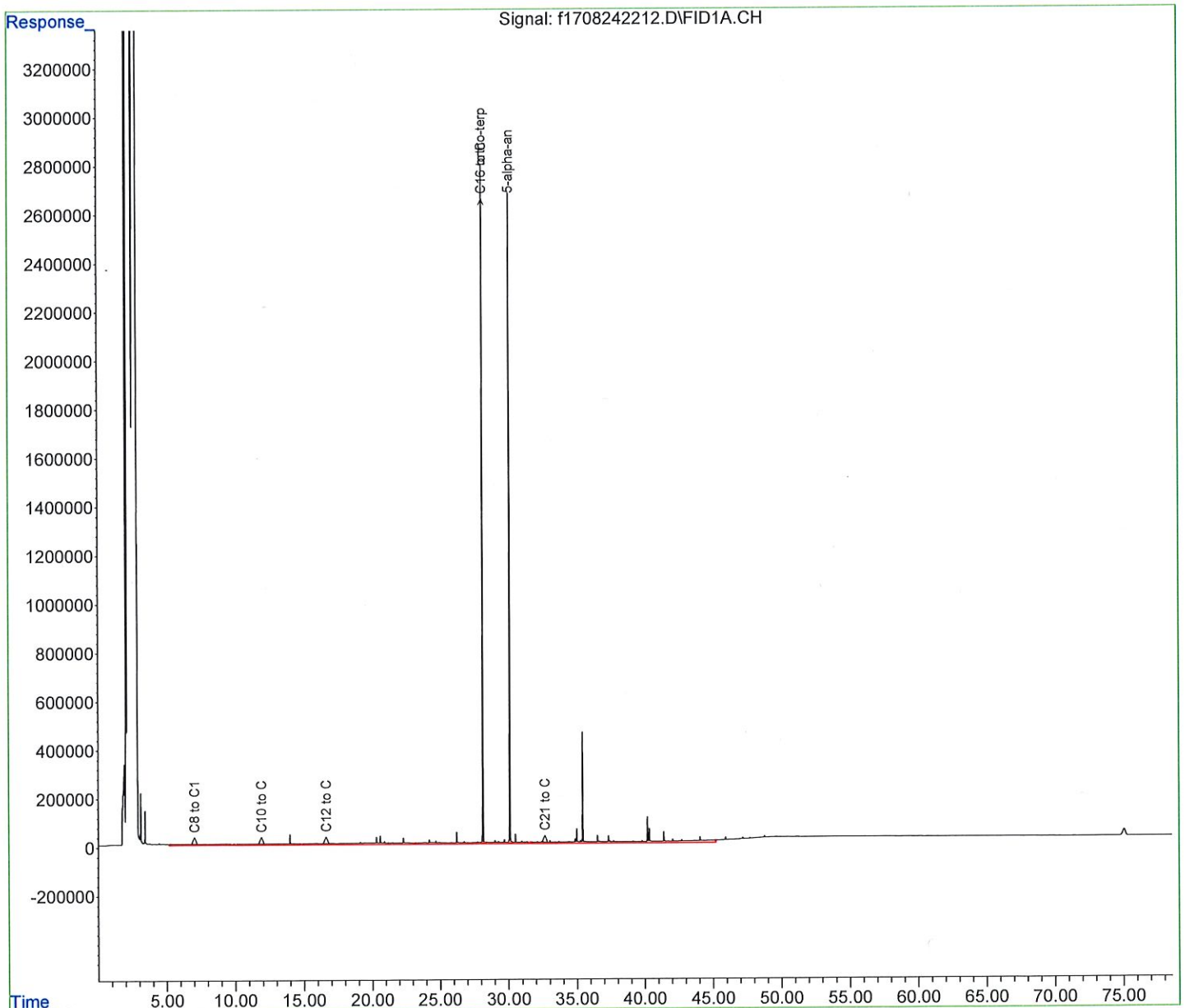



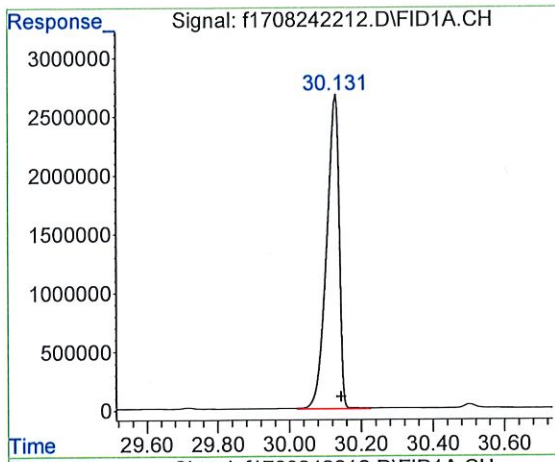

#1 5-alpha-androstane  
 R.T.: 30.131 min  
 Delta R.T.: -0.014 min  
 Response: 64228646  
 Conc: 50.00 ug/mL m

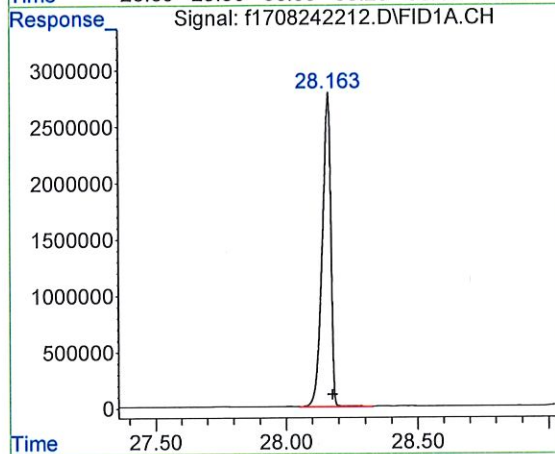

#2 ortho-terphenyl  
 R.T.: 28.163 min  
 Delta R.T.: -0.014 min  
 Response: 62124248  
 Conc: 46.27 ug/mL m

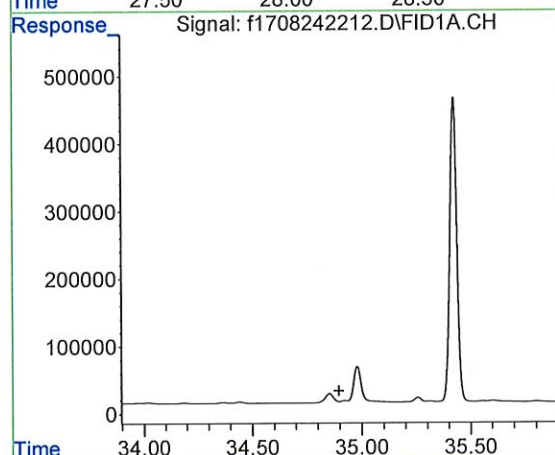

#3 d50-Tetracosane  
 R.T.: 0.000 min  
 Exp R.T. : 34.896 min  
 Response: 0  
 Conc: N.D.

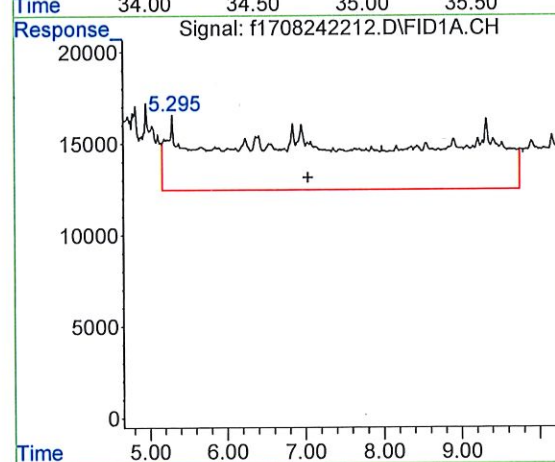

#4 > C8 to C10 Aliphatics  
 R.T.: 7.043 min  
 Delta R.T.: 0.000 min  
 Response: 6387733  
 Conc: 5.28 ug/mL m

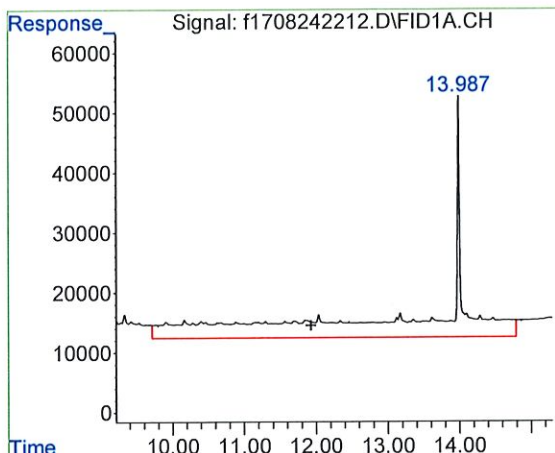

#5 > C10 to C12 Aliphatics

R.T.: 11.928 min  
 Delta R.T.: 0.000 min  
 Response: 8442061  
 Conc: 6.98 ug/ml m

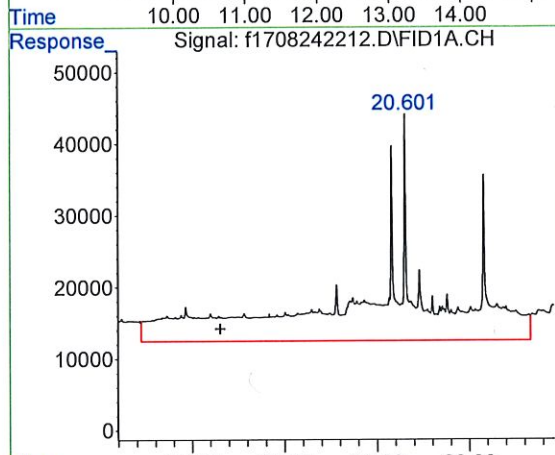

#6 > C12 to C16 Aliphatics

R.T.: 16.619 min  
 Delta R.T.: 0.000 min  
 Response: 21575818  
 Conc: 17.83 UG/ML m

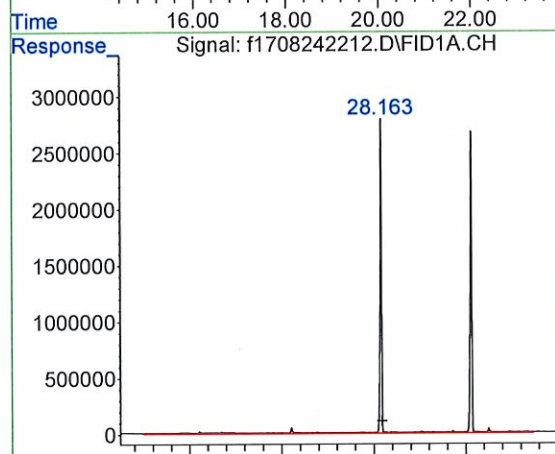

#7 > C16 to C21 Aliphatics

R.T.: 28.177 min  
 Delta R.T.: 0.000 min  
 Response: 22492390  
 Conc: 18.59 UG/ML m

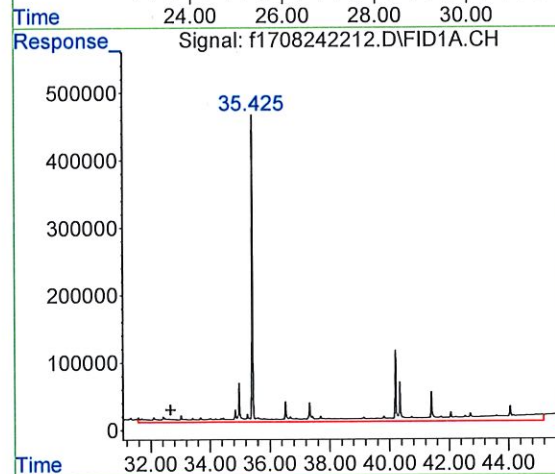

#8 > C21 to C32 Aliphatics

R.T.: 32.664 min  
 Delta R.T.: 0.000 min  
 Response: 57886459  
 Conc: 47.84 UG/ML m

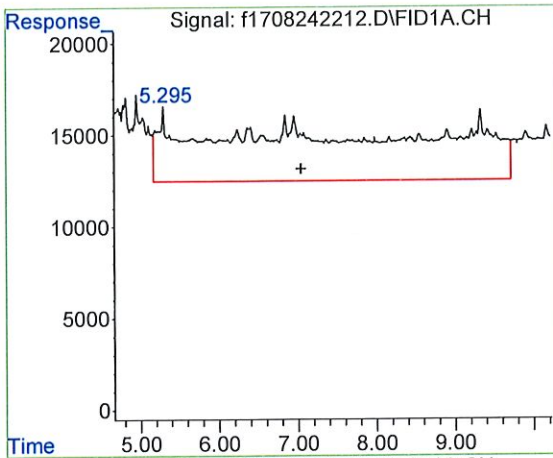

#9 > C8 to C10 Aromatics

R.T.: 7.043 min  
 Delta R.T.: 0.000 min  
 Response: 6301191  
 Conc: 5.21 UG/ML m

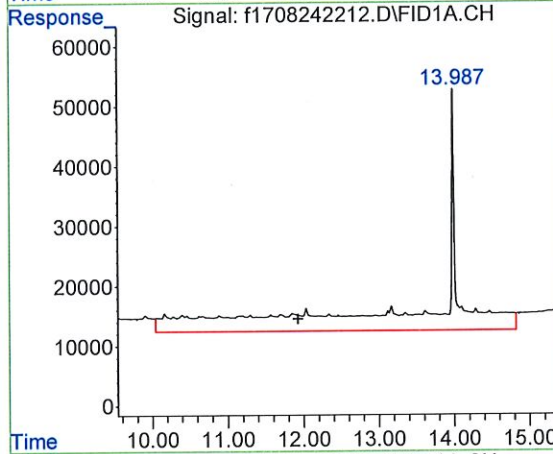

#10 > C10 to C12 Aromatics

R.T.: 11.928 min  
 Delta R.T.: 0.000 min  
 Response: 8032661  
 Conc: 6.64 UG/ML m

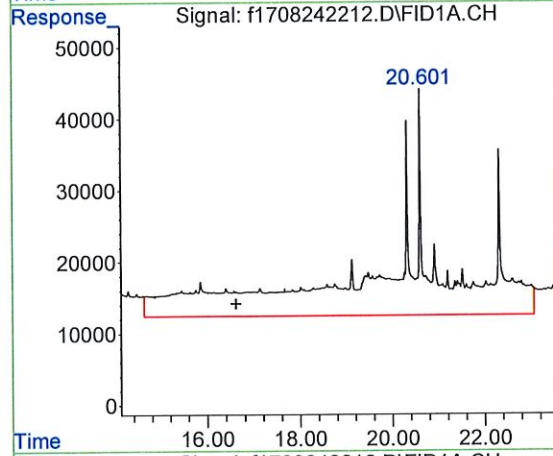

#11 > C12 to C16 Aromatics

R.T.: 16.619 min  
 Delta R.T.: 0.000 min  
 Response: 21433732  
 Conc: 17.71 UG/ML m

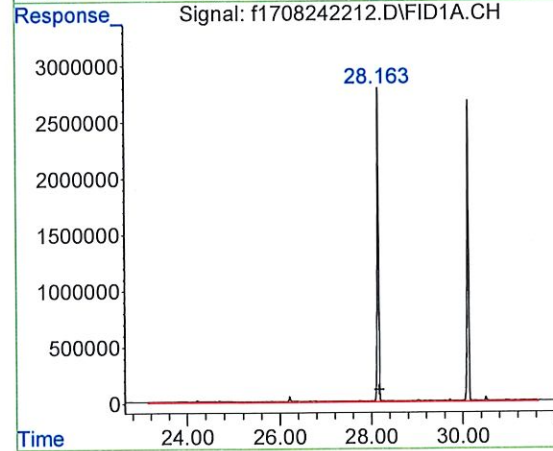

#12 > C16 to C21 Aromatics

R.T.: 28.177 min  
 Delta R.T.: 0.000 min  
 Response: 22711550  
 Conc: 18.77 UG/ML m

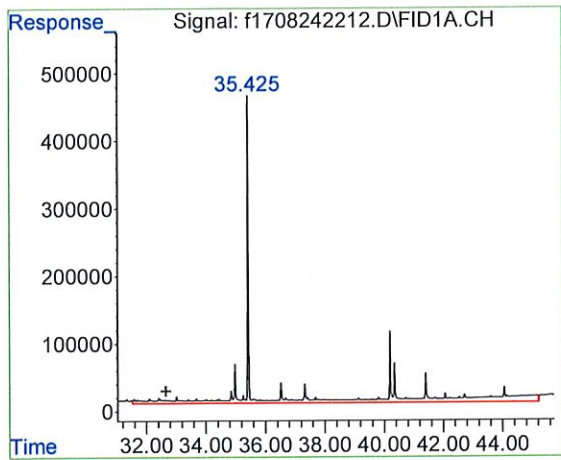

#13 > C21 to C32 Aromatics

R.T.: 32.664 min  
Delta R.T.: 0.000 min  
Response: 58236843  
Conc: 48.13 UG/ML m



Quantitation Report (QT Reviewed)

Data Path : C:\Projects\Hawaii DOH\2. Laboratory Data\Alpha\Carbon Range Study\L2240634\TPH\NF TPH\  
Data File : f1708242224.D  
Signal(s) : FID1A.CH  
Acq On : 25 Aug 2022 19:02 pm  
Operator : FID17:WR  
Sample : L2240634-03,42,,  
Misc : WG1679263,WG1676458,ICAL18753  
ALS Vial : 12 Sample Multiplier: 1

Integration File: autoint1.e  
Quant Time: Oct 22 20:49:02 2022  
Quant Method : C:\Projects\Hawaii DOH\2. Laboratory Data\Alpha\Carbon Range Study\L2240634\TPH\NF TPH\  
Quant Title : FID Forensics  
QLast Update : Fri Sep 23 15:53:13 2022  
Response via : Initial Calibration  
Integrator: ChemStation 6890 Scale Mode: Large solvent peaks clipped

Volume Inj. :  
Signal Phase :  
Signal Info :

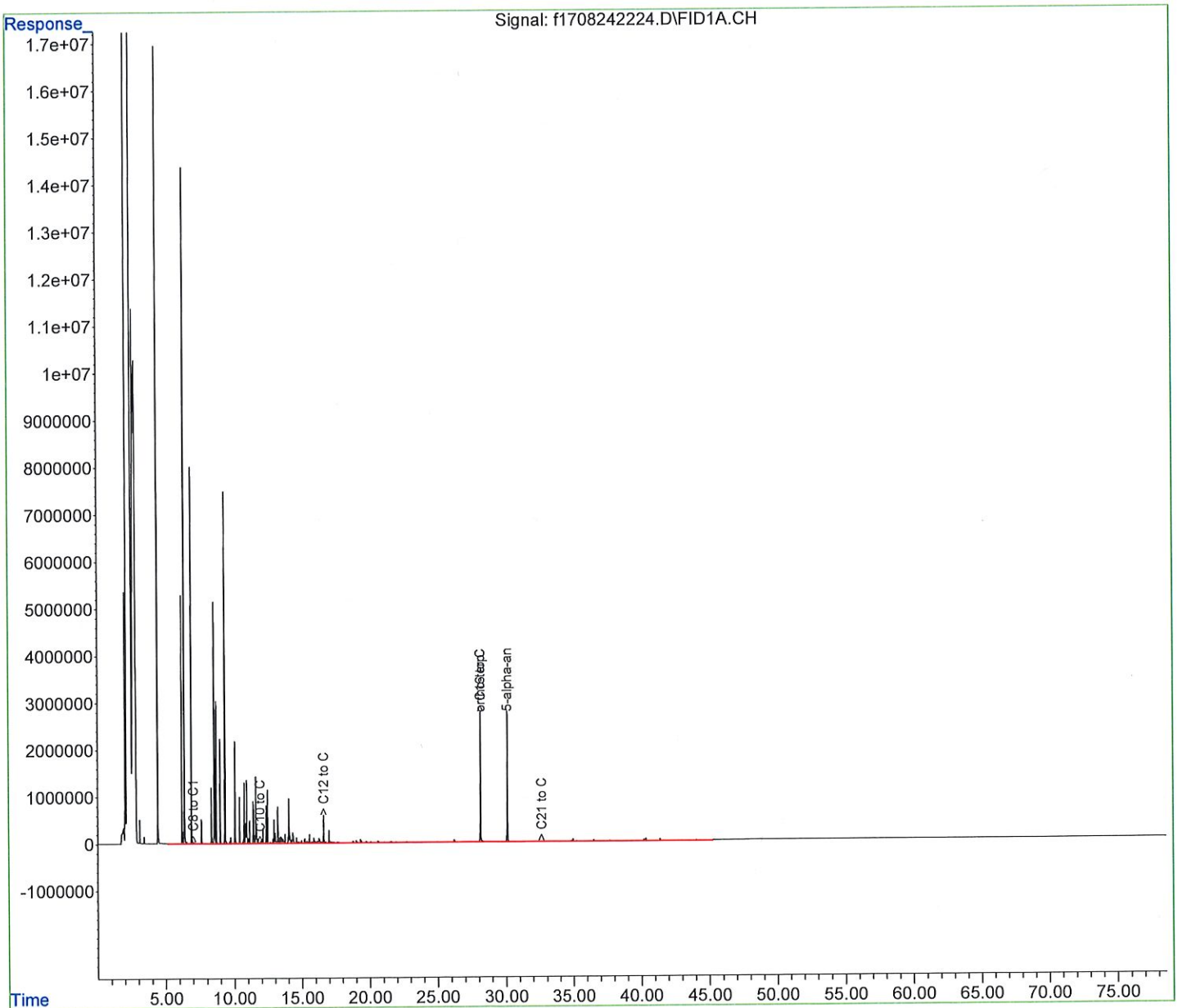

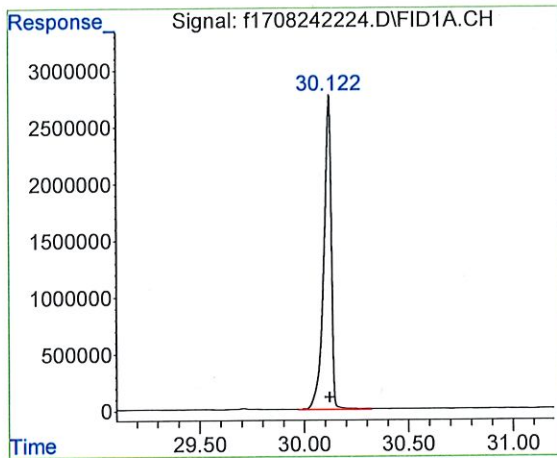

#1 5-alpha-androstane

R.T.: 30.122 min  
 Delta R.T.: 0.000 min  
 Response: 68685134  
 Conc: 50.00 ug/mL m

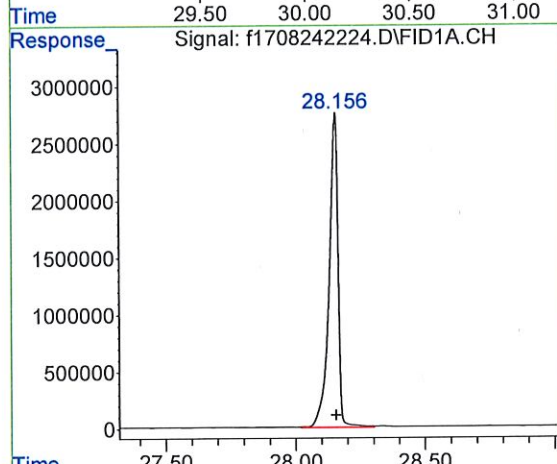

#2 ortho-terphenyl

R.T.: 28.156 min  
 Delta R.T.: 0.000 min  
 Response: 65980584  
 Conc: 45.95 ug/mL m

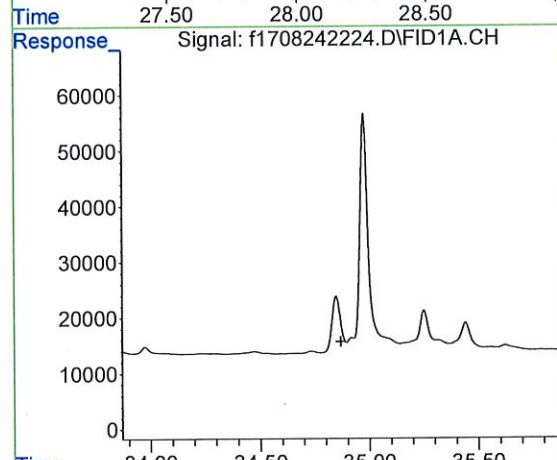

#3 d50-Tetracosane

R.T.: 0.000 min  
 Exp R.T. : 34.869 min  
 Response: 0  
 Conc: N.D.

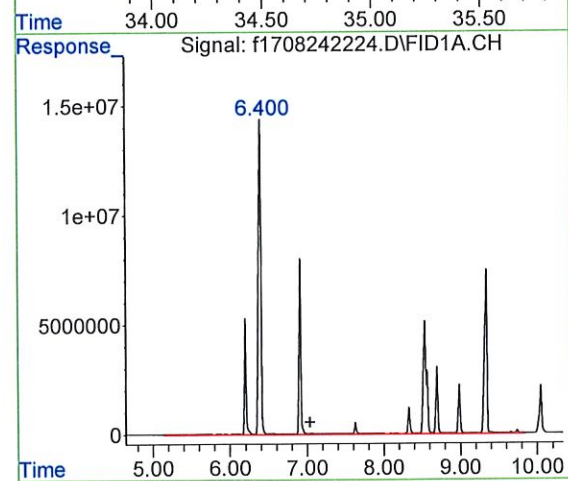

#9 > C8 to C10 Aromatics

R.T.: 7.038 min  
 Delta R.T.: 0.000 min  
 Response: 1010230151  
 Conc: 780.68 UG/ML m

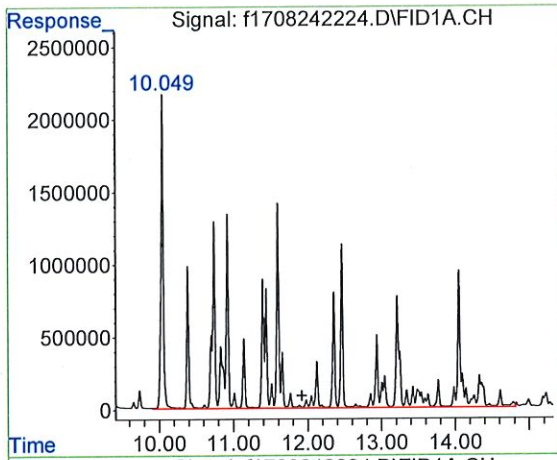

#10 > C10 to C12 Aromatics

R.T.: 11.919 min  
 Delta R.T.: 0.000 min  
 Response: 368352040  
 Conc: 284.65 UG/ML m

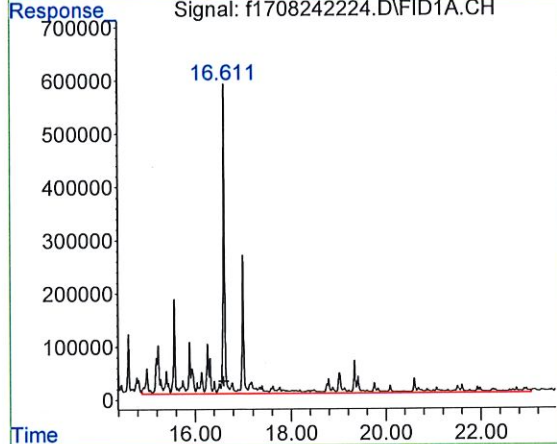

#11 > C12 to C16 Aromatics

R.T.: 16.606 min  
 Delta R.T.: 0.000 min  
 Response: 60241628  
 Conc: 46.55 UG/ML m

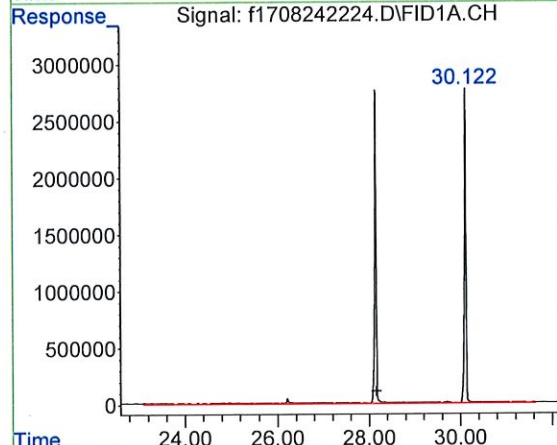

#12 > C16 to C21 Aromatics

R.T.: 28.155 min  
 Delta R.T.: 0.000 min  
 Response: 13343626  
 Conc: 10.31 UG/ML m

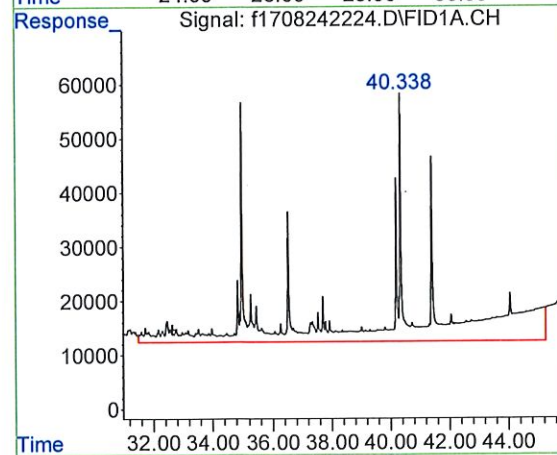

#13 > C21 to C32 Aromatics

R.T.: 32.639 min  
 Delta R.T.: 0.000 min  
 Response: 26472456  
 Conc: 20.46 UG/ML m



Quantitation Report (QT Reviewed)

Data Path : C:\Projects\Hawaii DOH\2. Laboratory Data\Alpha\Carbon Range Study\L2240634\TPH\NF TPH\  
Data File : f1708242226.D  
Signal(s) : FID1A.CH  
Acq On : 25 Aug 2022 20:32 pm  
Operator : FID17:WR  
Sample : WG1676458-4,42,,  
Misc : WG1679263,WG1676458,ICAL18753  
ALS Vial : 13 Sample Multiplier: 1

Integration File: autoint1.e  
Quant Time: Oct 22 20:59:55 2022  
Quant Method : C:\Projects\Hawaii DOH\2. Laboratory Data\Alpha\Carbon Range Study\L2240634\TPH\NF TPH\NF TPH (   
Quant Title : FID Forensics  
QLast Update : Fri Sep 23 15:53:13 2022  
Response via : Initial Calibration  
Integrator: ChemStation 6890 Scale Mode: Large solvent peaks clipped

Volume Inj. :  
Signal Phase :  
Signal Info :

Compound	R.T.	Response	Conc Units
Internal Standards			
1) I 5-alpha-androstane	30.124	74384322	50.000 ug/mLm

System Monitoring Compounds  
2) s ortho-terphenyl 28.158 70270710 45.189 ug/mLm  
Spiked Amount 50.000 Range 50 - 130 Recovery = 90.38%

Target Compounds			
9) h > C8 to C10 Aromatics	7.038	1105087659	788.548 UG/MLm
10) h > C10 to C12 Aromatics	11.919	410311734	292.783 UG/MLm
11) h > C12 to C16 Aromatics	16.606	68801366	49.094 UG/MLm
12) h > C16 to C21 Aromatics	28.155	14710868	10.497 UG/MLm
13) h > C21 to C32 Aromatics	32.639	25715230	18.349 UG/MLm

SemiQuant Compounds - Not Calibrated on this Instrument

(f)=RT Delta > 1/2 Window (m)=manual int.

Quantitation Report (QT Reviewed)

Data Path : C:\Projects\Hawaii DOH\2. Laboratory Data\Alpha\Carbon Range Study\L2240634\TPH\NF TPH\  
Data File : f1708242226.D  
Signal(s) : FID1A.CH  
Acq On : 25 Aug 2022 20:32 pm  
Operator : FID17:WR  
Sample : WG1676458-4,42,,  
Misc : WG1679263,WG1676458,ICAL18753  
ALS Vial : 13 Sample Multiplier: 1

Integration File: autoint1.e  
Quant Time: Oct 22 20:59:55 2022  
Quant Method : C:\Projects\Hawaii DOH\2. Laboratory Data\Alpha\Carbon Range Study\L2240634\TPH\NF TPH\  
Quant Title : FID Forensics  
QLast Update : Fri Sep 23 15:53:13 2022  
Response via : Initial Calibration  
Integrator: ChemStation 6890 Scale Mode: Large solvent peaks clipped

Volume Inj. :  
Signal Phase :  
Signal Info :

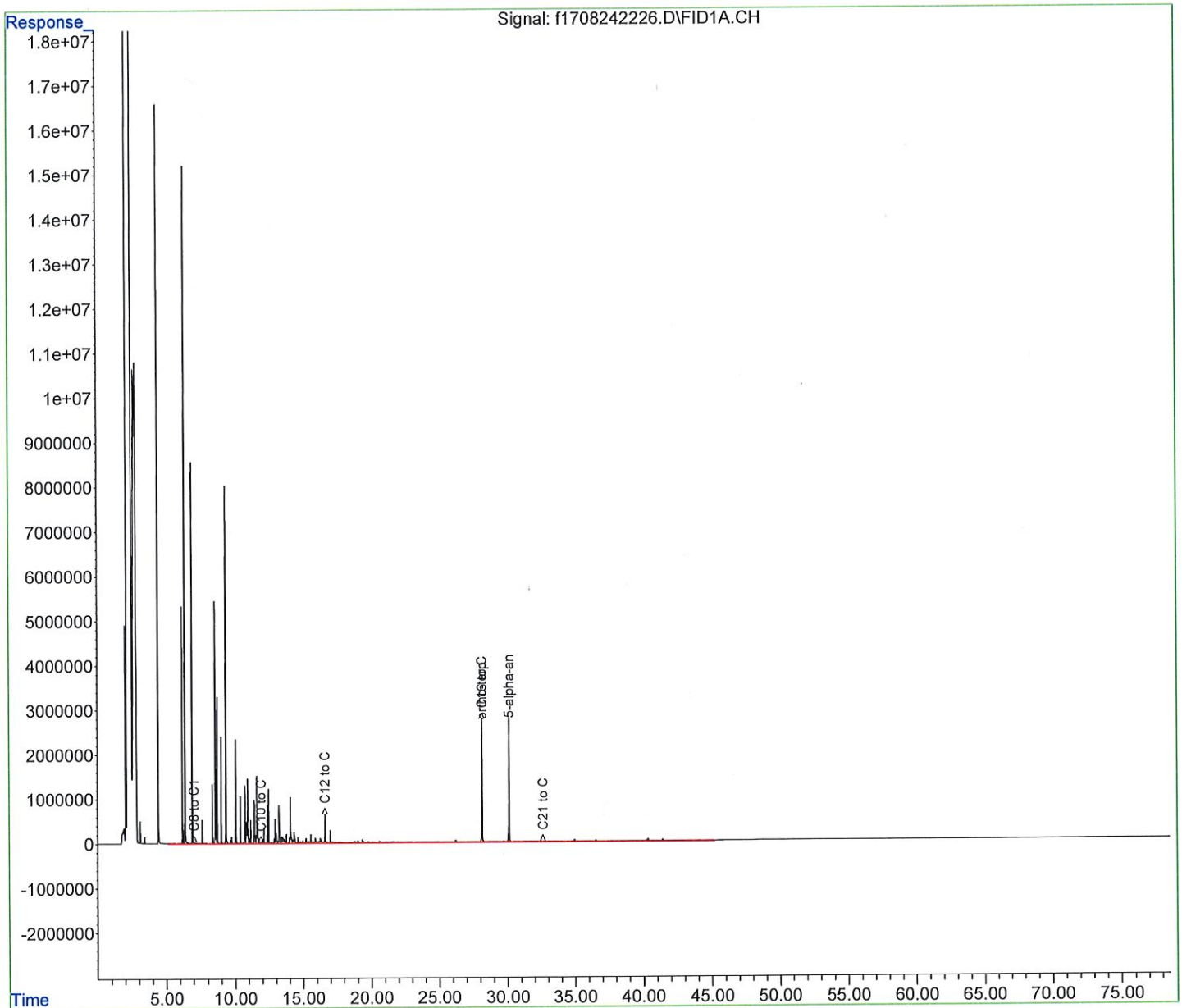

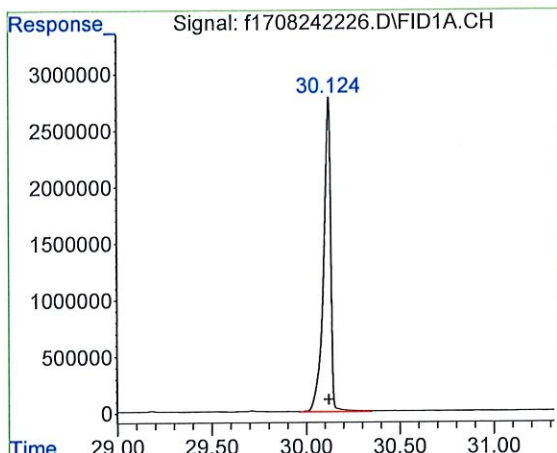

#1 5-alpha-androstane  
 R.T.: 30.124 min  
 Delta R.T.: 0.002 min  
 Response: 74384322  
 Conc: 50.00 ug/mL m

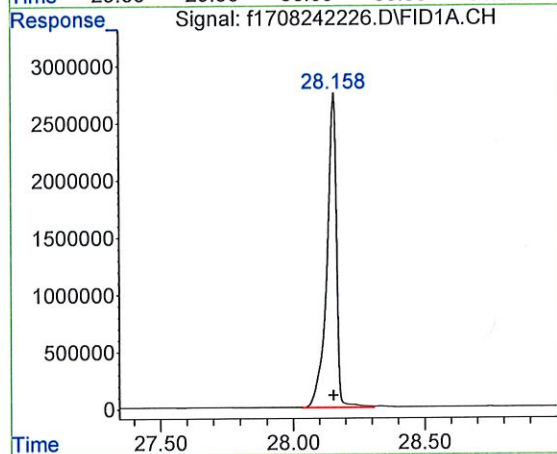

#2 ortho-terphenyl  
 R.T.: 28.158 min  
 Delta R.T.: 0.003 min  
 Response: 70270710  
 Conc: 45.19 ug/mL m

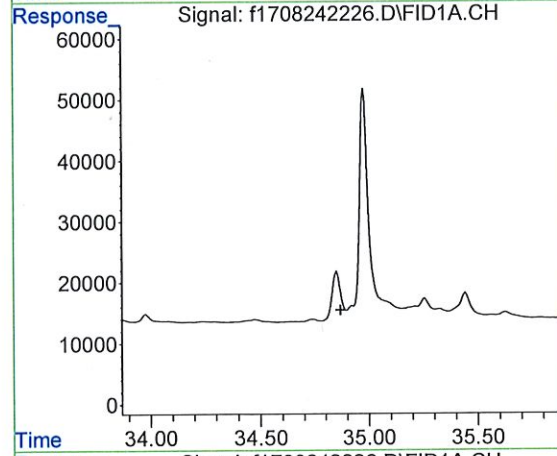

#3 d50-Tetracosane  
 R.T.: 0.000 min  
 Exp R.T. : 34.869 min  
 Response: 0  
 Conc: N.D.

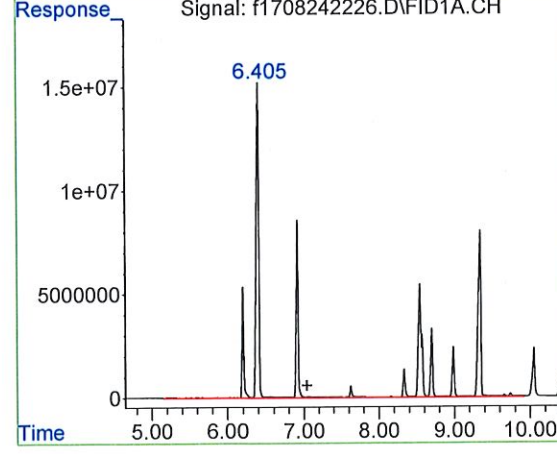

#9 > C8 to C10 Aromatics  
 R.T.: 7.038 min  
 Delta R.T.: 0.000 min  
 Response: 1105087659  
 Conc: 788.55 UG/ML m

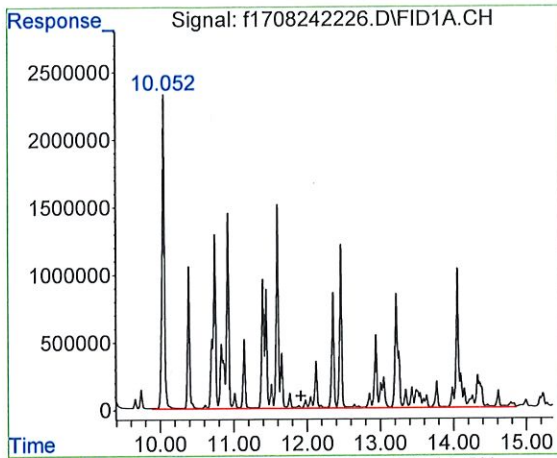

#10 > C10 to C12 Aromatics

R.T.: 11.919 min  
 Delta R.T.: 0.000 min  
 Response: 410311734  
 Conc: 292.78 UG/ML m

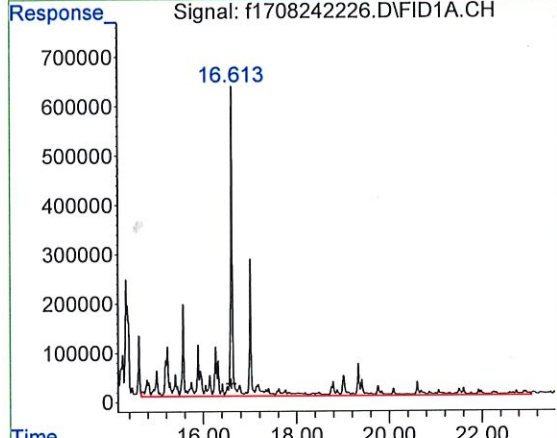

#11 > C12 to C16 Aromatics

R.T.: 16.606 min  
 Delta R.T.: 0.000 min  
 Response: 68801366  
 Conc: 49.09 UG/ML m

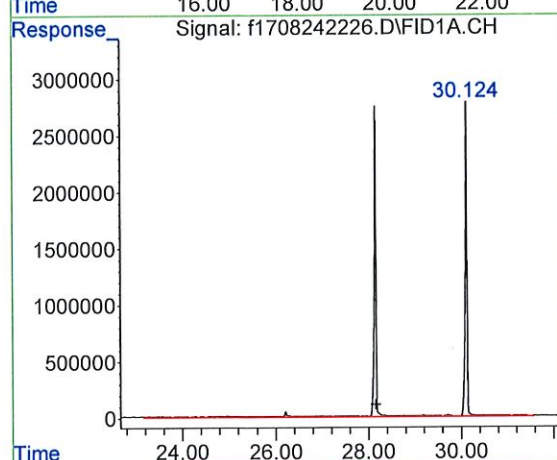

#12 > C16 to C21 Aromatics

R.T.: 28.155 min  
 Delta R.T.: 0.000 min  
 Response: 14710868  
 Conc: 10.50 UG/ML m

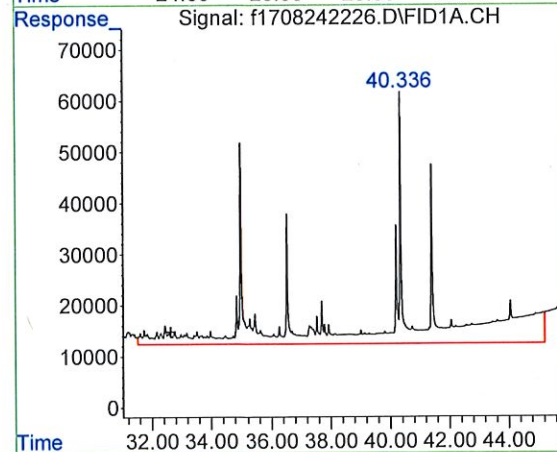

#13 > C21 to C32 Aromatics

R.T.: 32.639 min  
 Delta R.T.: 0.000 min  
 Response: 25715230  
 Conc: 18.35 UG/ML m



Quantitation Report (QT Reviewed)

Data Path : C:\Projects\Hawaii DOH\2. Laboratory Data\Alpha\Carbon Range Study\L2240634\TPH\NF TPH\  
Data File : f1708242228.D  
Signal(s) : FID1A.CH  
Acq On : 25 Aug 2022 22:03 pm  
Operator : FID17:WR  
Sample : L2240634-06,42,,  
Misc : WG1679263,WG1676458,ICAL18753  
ALS Vial : 14 Sample Multiplier: 1

Integration File: autoint1.e  
Quant Time: Oct 22 21:04:57 2022  
Quant Method : C:\Projects\Hawaii DOH\2. Laboratory Data\Alpha\Carbon Range Study\L2240634\TPH\NF TPH\NF TPH  
Quant Title : FID Forensics  
QLast Update : Fri Sep 23 15:53:13 2022  
Response via : Initial Calibration  
Integrator: ChemStation 6890 Scale Mode: Large solvent peaks clipped

Volume Inj. :  
Signal Phase :  
Signal Info :

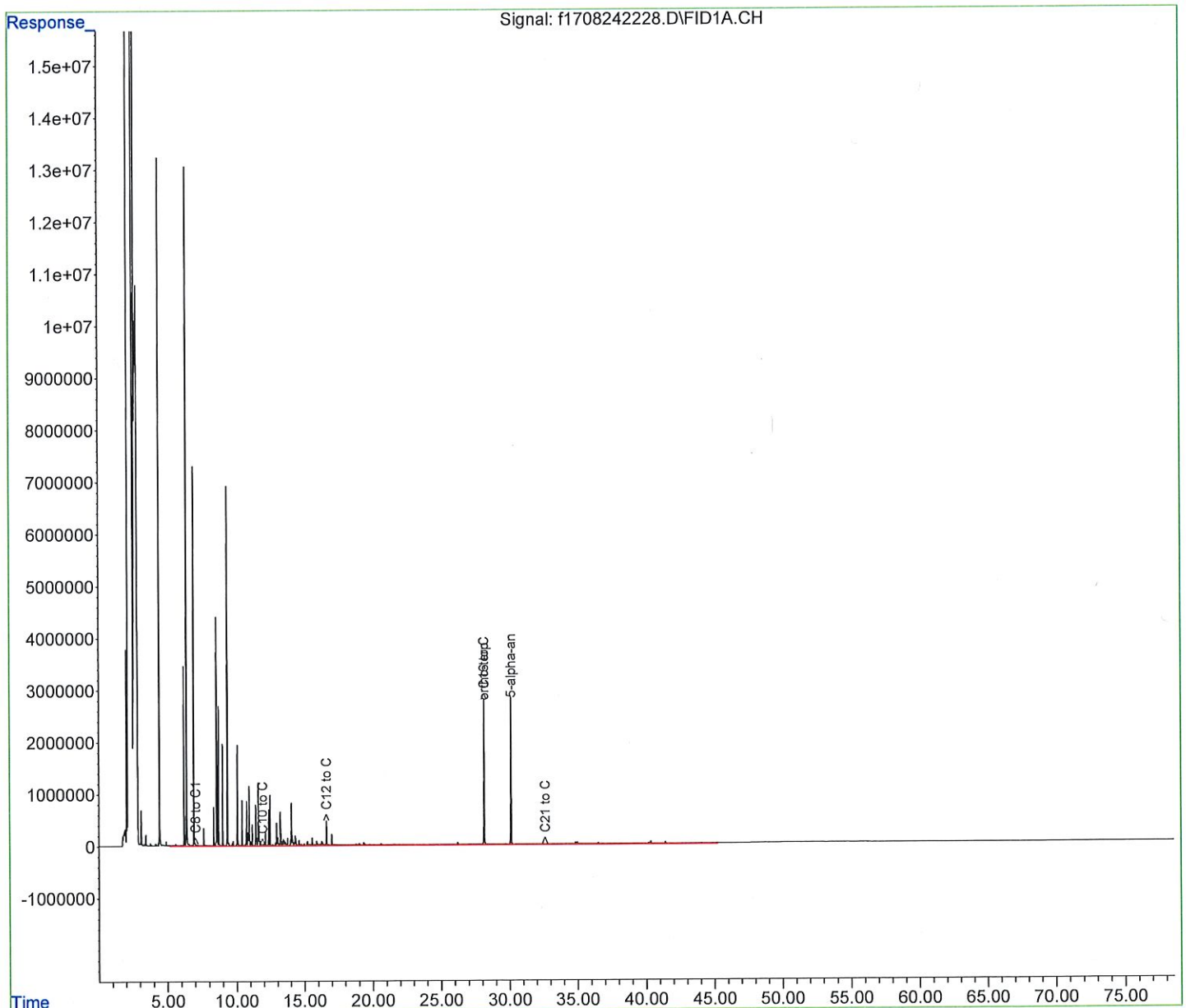

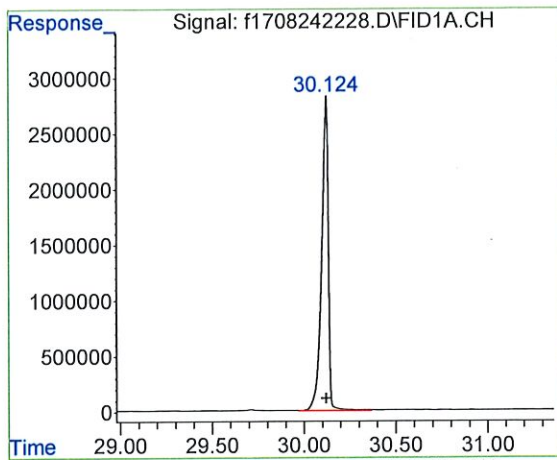

#1 5-alpha-androstane  
 R.T.: 30.124 min  
 Delta R.T.: 0.002 min  
 Response: 70581674  
 Conc: 50.00 ug/mL m

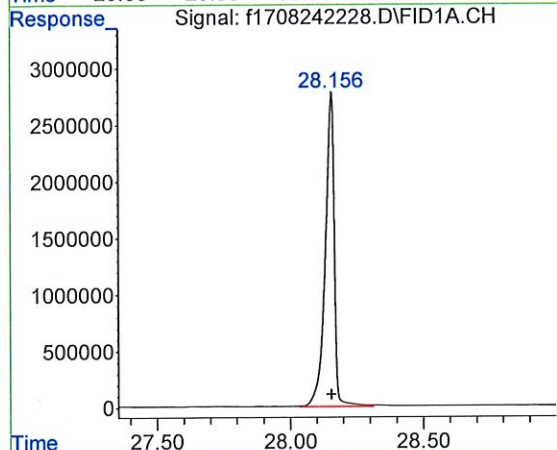

#2 ortho-terphenyl  
 R.T.: 28.156 min  
 Delta R.T.: 0.001 min  
 Response: 66111087  
 Conc: 44.80 ug/mL m

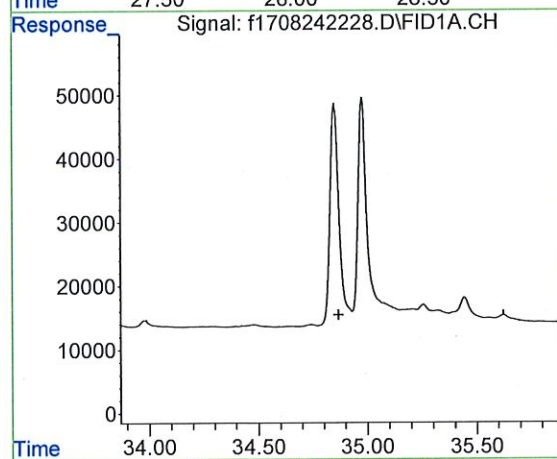

#3 d50-Tetracosane  
 R.T.: 0.000 min  
 Exp R.T. : 34.869 min  
 Response: 0  
 Conc: N.D.

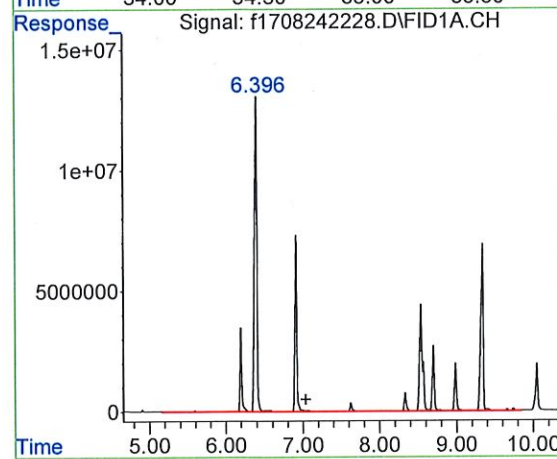

#9 > C8 to C10 Aromatics  
 R.T.: 7.038 min  
 Delta R.T.: 0.000 min  
 Response: 858582569  
 Conc: 645.66 UG/ML m

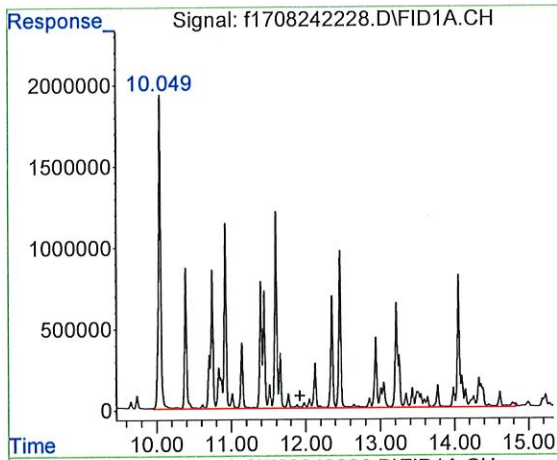

#10 > C10 to C12 Aromatics

R.T.: 11.919 min  
 Delta R.T.: 0.000 min  
 Response: 301708080  
 Conc: 226.89 UG/ML m

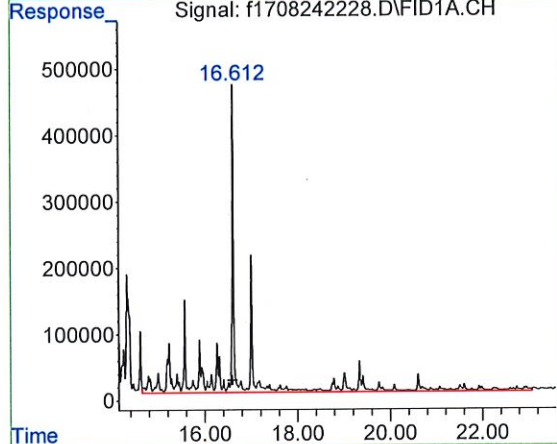

#11 > C12 to C16 Aromatics

R.T.: 16.606 min  
 Delta R.T.: 0.000 min  
 Response: 49508773  
 Conc: 37.23 UG/ML m

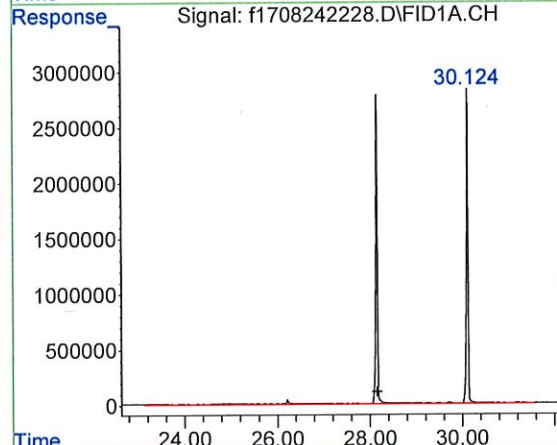

#12 > C16 to C21 Aromatics

R.T.: 28.155 min  
 Delta R.T.: 0.000 min  
 Response: 12195381  
 Conc: 9.17 UG/ML m

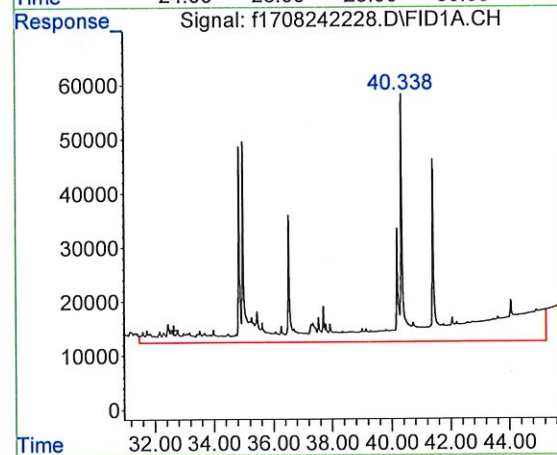

#13 > C21 to C32 Aromatics

R.T.: 32.639 min  
 Delta R.T.: 0.000 min  
 Response: 26623554  
 Conc: 20.02 UG/ML m





Quantitation Report (QT Reviewed)

Data Path : C:\Projects\Hawaii DOH\2. Laboratory Data\Alpha\Carbon Range Study\L2240634\TPH\NF TPH\  
Data File : f1708242230.D  
Signal(s) : FID1A.CH  
Acq On : 25 Aug 2022 23:34 pm  
Operator : FID17:WR  
Sample : L2240634-09,42,,  
Misc : WG1679263,WG1676458,ICAL18753  
ALS Vial : 15 Sample Multiplier: 1

Integration File: autoint1.e  
Quant Time: Oct 22 21:11:20 2022  
Quant Method : C:\Projects\Hawaii DOH\2. Laboratory Data\Alpha\Carbon Range Study\L2240634\TPH\NF TPH\  
Quant Title : FID Forensics  
QLast Update : Fri Sep 23 15:53:13 2022  
Response via : Initial Calibration  
Integrator: ChemStation 6890 Scale Mode: Large solvent peaks clipped

Volume Inj. :  
Signal Phase :  
Signal Info :

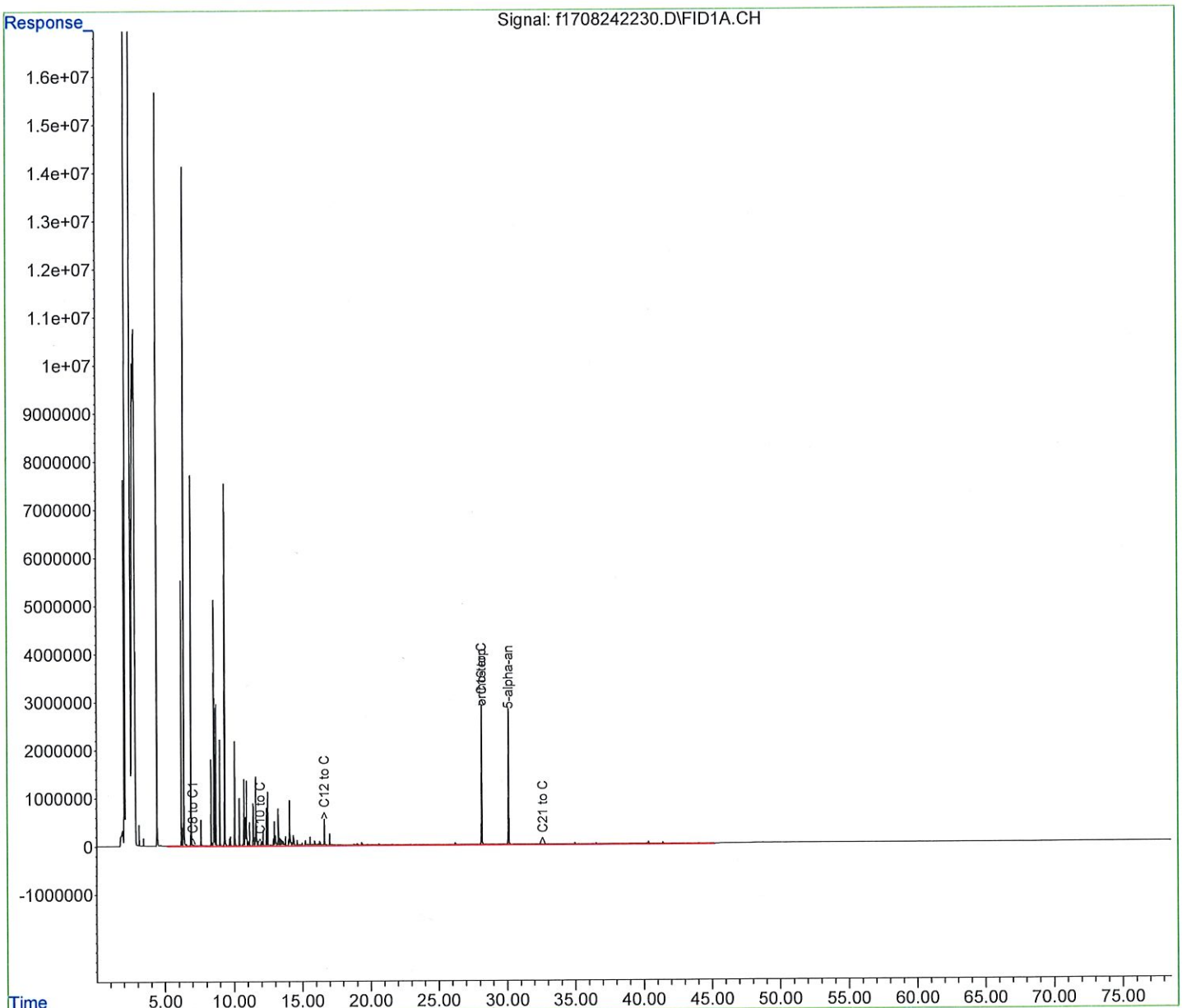

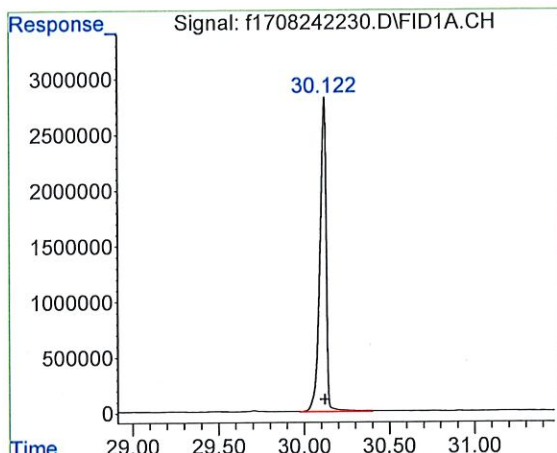

#1 5-alpha-androstane  
 R.T.: 30.122 min  
 Delta R.T.: 0.000 min  
 Response: 72636985  
 Conc: 50.00 ug/mL m

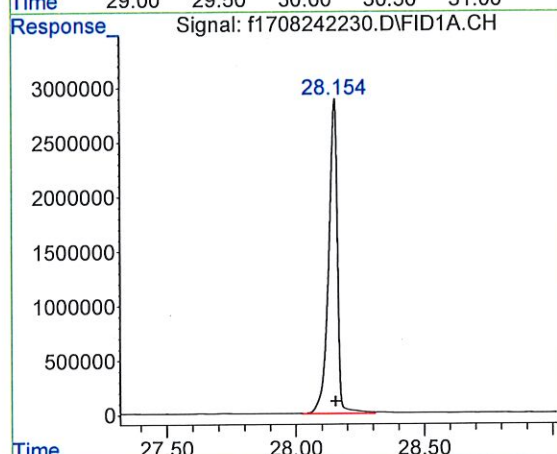

#2 ortho-terphenyl  
 R.T.: 28.154 min  
 Delta R.T.: -0.001 min  
 Response: 69326264  
 Conc: 45.65 ug/mL m

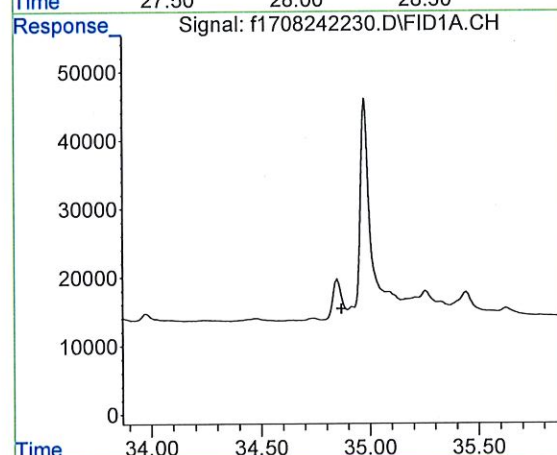

#3 d50-Tetracosane  
 R.T.: 0.000 min  
 Exp R.T. : 34.869 min  
 Response: 0  
 Conc: N.D.

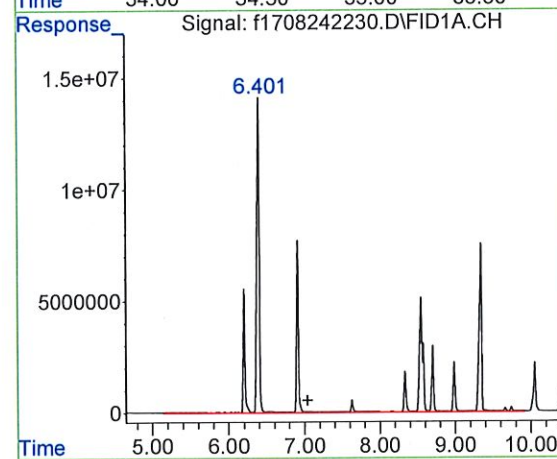

#9 > C8 to C10 Aromatics  
 R.T.: 7.038 min  
 Delta R.T.: 0.000 min  
 Response: 1013690776  
 Conc: 740.73 UG/ML m

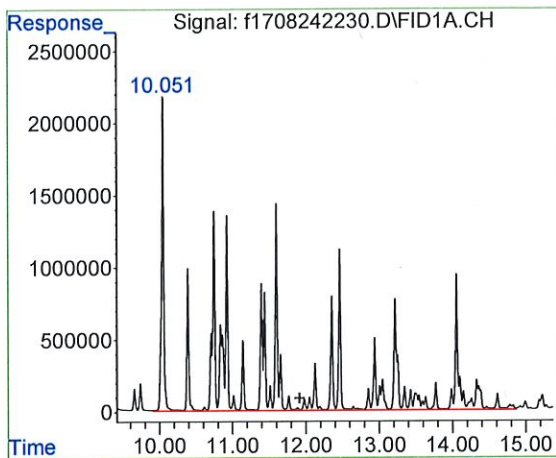

#10 > C10 to C12 Aromatics

R.T.: 11.919 min  
 Delta R.T.: 0.000 min  
 Response: 369937163  
 Conc: 270.32 UG/ML m

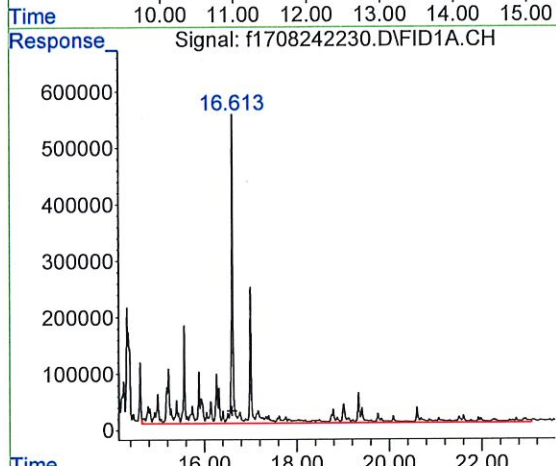

#11 > C12 to C16 Aromatics

R.T.: 16.606 min  
 Delta R.T.: 0.000 min  
 Response: 60609790  
 Conc: 44.29 UG/ML m

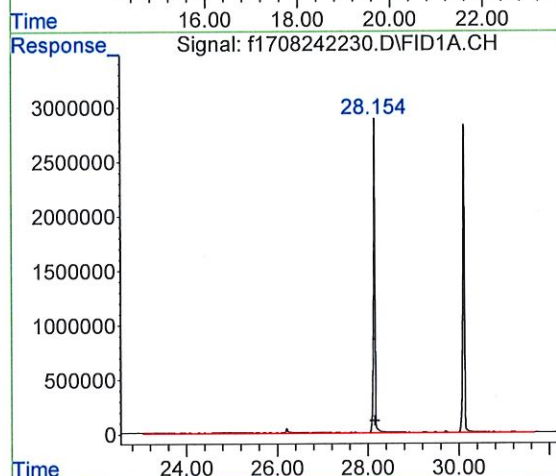

#12 > C16 to C21 Aromatics

R.T.: 28.155 min  
 Delta R.T.: 0.000 min  
 Response: 14743870  
 Conc: 10.77 UG/ML m

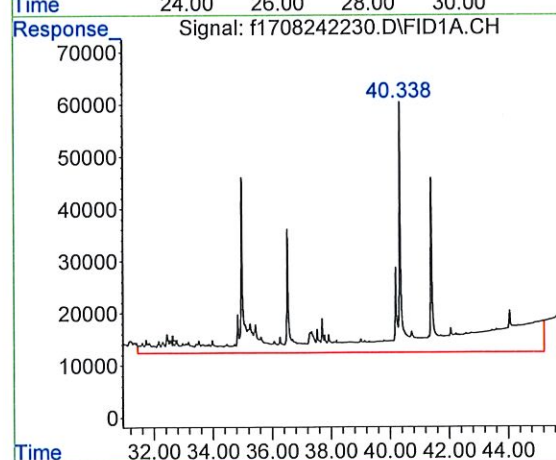

#13 > C21 to C32 Aromatics

R.T.: 32.639 min  
 Delta R.T.: 0.000 min  
 Response: 26522518  
 Conc: 19.38 UG/ML m



Quantitation Report (QT Reviewed)

Data Path : C:\Projects\Hawaii DOH\2. Laboratory Data\Alpha\Carbon Range Study\L2240634\TPH\NF TPH\  
Data File : f1708242232.D  
Signal(s) : FID1A.CH  
Acq On : 26 Aug 2022 1:04 am  
Operator : FID17:WR  
Sample : L2240634-12,42,,  
Misc : WG1679263,WG1676458,ICAL18753  
ALS Vial : 16 Sample Multiplier: 1

Integration File: autoint1.e  
Quant Time: Oct 27 13:27:44 2022  
Quant Method : C:\Projects\Hawaii DOH\2. Laboratory Data\Alpha\Carbon Range Study\L2240634\TPH\NF TPH\  
Quant Title : FID Forensics  
QLast Update : Fri Sep 23 15:53:13 2022  
Response via : Initial Calibration  
Integrator: ChemStation 6890 Scale Mode: Large solvent peaks clipped

Volume Inj. :  
Signal Phase :  
Signal Info :

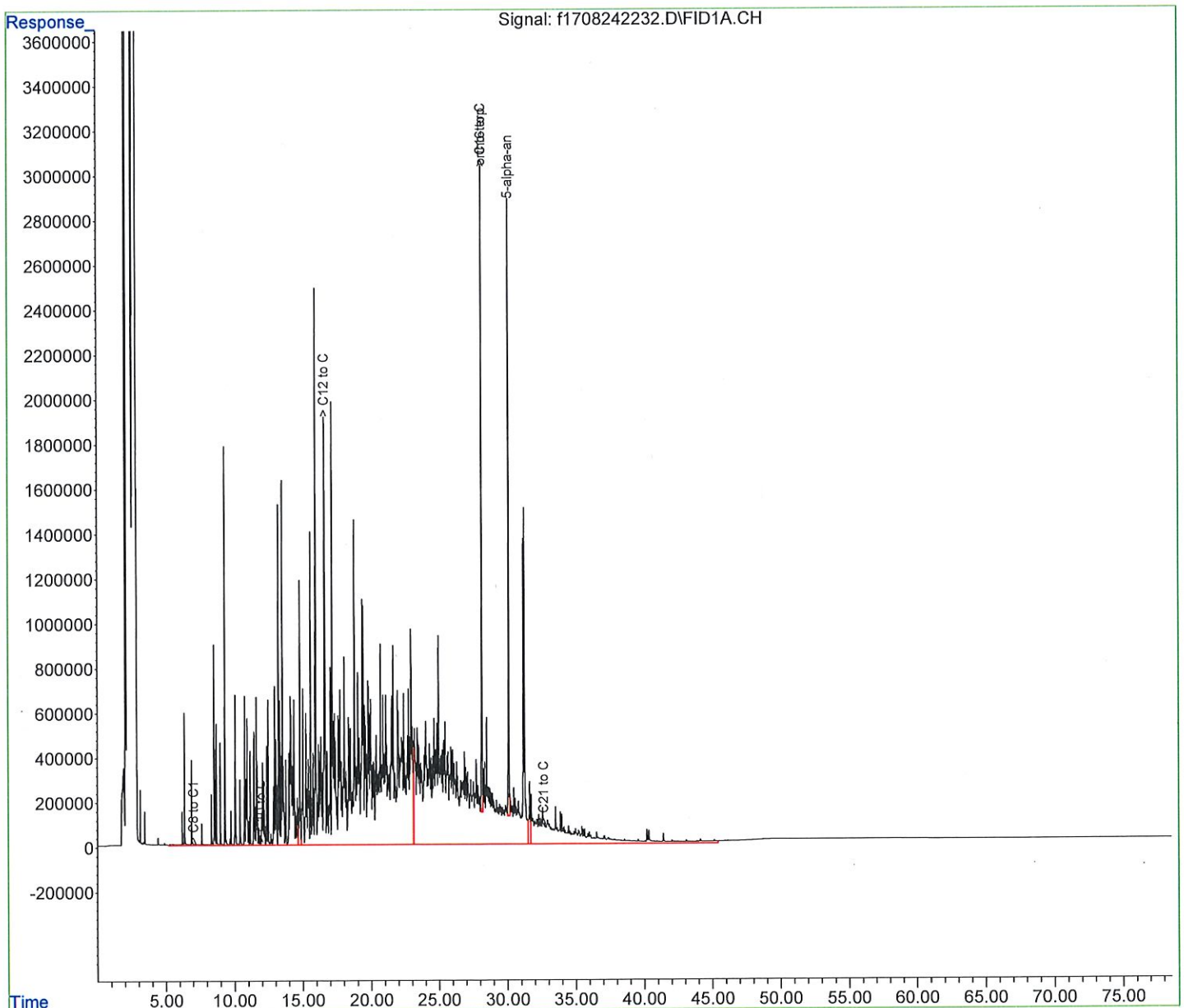

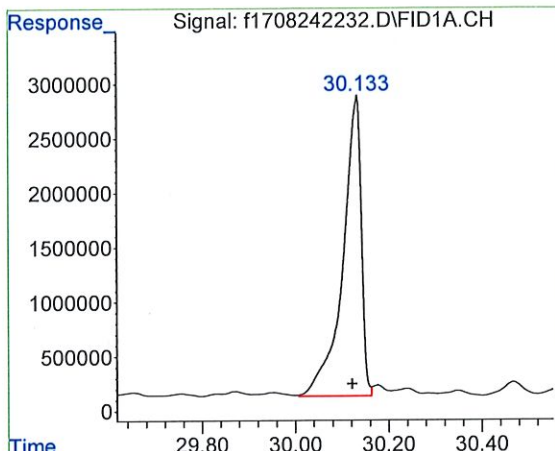

#1 5-alpha-androstane  
 R.T.: 30.133 min  
 Delta R.T.: 0.011 min  
 Response: 75161742  
 Conc: 50.00 ug/mL m

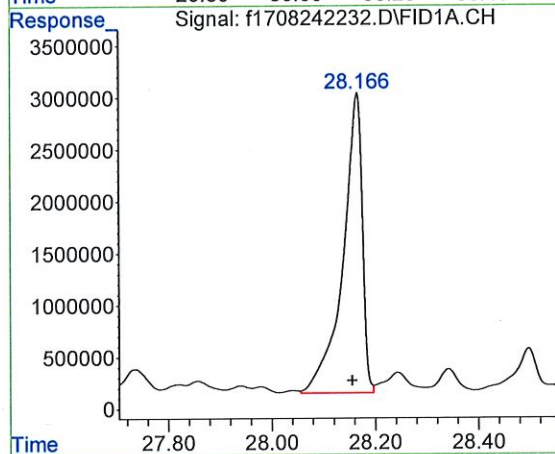

#2 ortho-terphenyl  
 R.T.: 28.166 min  
 Delta R.T.: 0.011 min  
 Response: 74758755  
 Conc: 47.58 ug/mL m

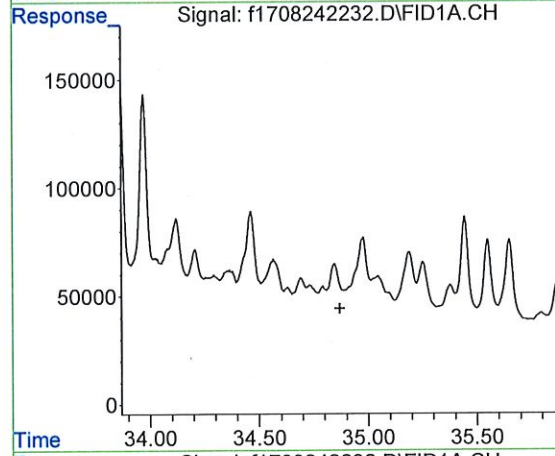

#3 d50-Tetracosane  
 R.T.: 0.000 min  
 Exp R.T. : 34.869 min  
 Response: 0  
 Conc: N.D.

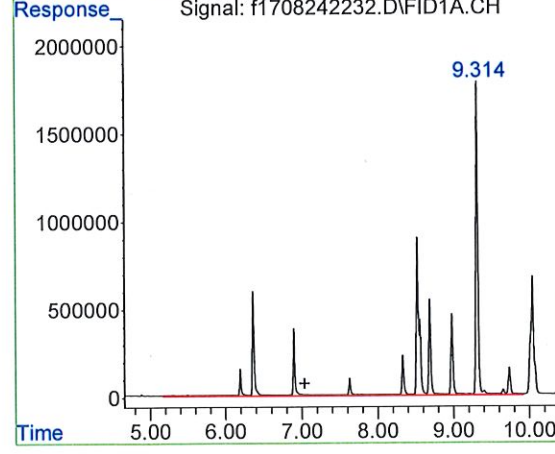

#9 > C8 to C10 Aromatics  
 R.T.: 7.038 min  
 Delta R.T.: 0.000 min  
 Response: 104636851  
 Conc: 73.89 UG/ML m

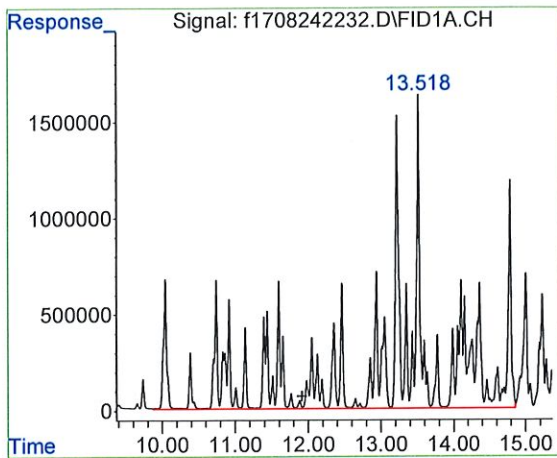

#10 > C10 to C12 Aromatics

R.T.: 11.919 min  
 Delta R.T.: 0.000 min  
 Response: 481655372  
 Conc: 340.14 UG/ML m

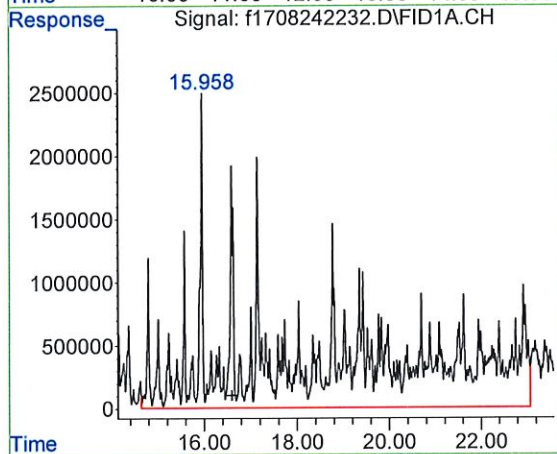

#11 > C12 to C16 Aromatics

R.T.: 16.606 min  
 Delta R.T.: 0.000 min  
 Response: 1765221219  
 Conc: 1246.57 UG/ML m

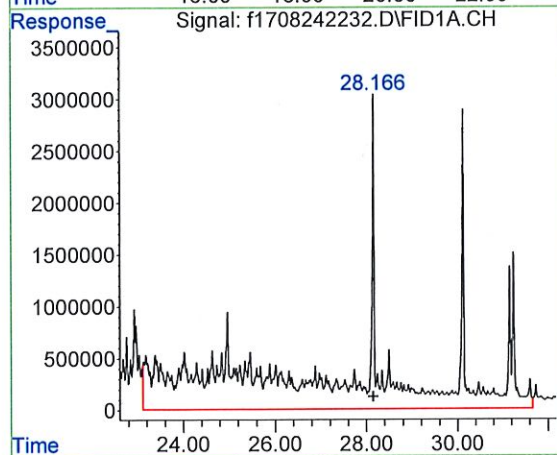

#12 > C16 to C21 Aromatics

R.T.: 28.155 min  
 Delta R.T.: 0.000 min  
 Response: 1314202337  
 Conc: 928.06 UG/ML m

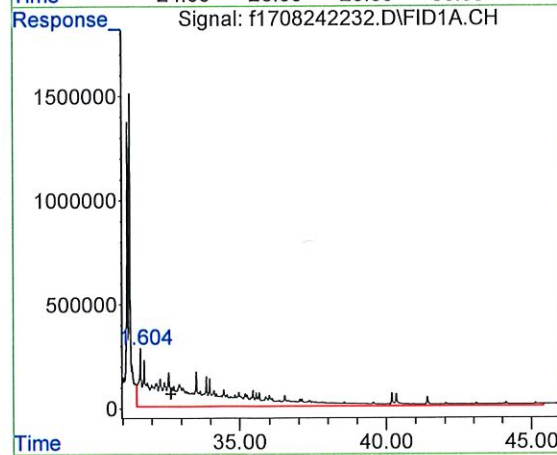

#13 > C21 to C32 Aromatics

R.T.: 32.639 min  
 Delta R.T.: 0.000 min  
 Response: 255262767  
 Conc: 180.26 UG/ML m



Quantitation Report (QT Reviewed)

Data Path : C:\Projects\Hawaii DOH\2. Laboratory Data\Alpha\Carbon Range Study\L2240634\TPH\NF TPH\  
Data File : f1708242234.D  
Signal(s) : FID1A.CH  
Acq On : 26 Aug 2022 2:34 am  
Operator : FID17:WR  
Sample : L2240634-15,42,,  
Misc : WG1679263,WG1676458,ICAL18753  
ALS Vial : 17 Sample Multiplier: 1

Integration File: autoint1.e  
Quant Time: Oct 27 13:34:52 2022  
Quant Method : C:\Projects\Hawaii DOH\2. Laboratory Data\Alpha\Carbon Range Study\L2240634\TPH\NF TPH\NF TPH (   
Quant Title : FID Forensics  
QLast Update : Fri Sep 23 15:53:13 2022  
Response via : Initial Calibration  
Integrator: ChemStation 6890 Scale Mode: Large solvent peaks clipped

Volume Inj. :  
Signal Phase :  
Signal Info :

Compound	R.T.	Response	Conc Units
-----			
Internal Standards			
1) l 5-alpha-androstane	30.133	72014007	50.000 ug/mLm
System Monitoring Compounds			
2) s ortho-terphenyl	28.163	61848218	41.082 ug/mLm
Spiked Amount	50.000	Range 50 - 130	Recovery = 82.16%
Target Compounds			
9) h > C8 to C10 Aromatics	7.038	341284260	251.543 UG/MLm
10) h > C10 to C12 Aromatics	11.919	641781980	473.024 UG/MLm
11) h > C12 to C16 Aromatics	16.606	1670378414	1231.150 UG/MLm
12) h > C16 to C21 Aromatics	28.155	1143684784	842.951 UG/MLm
13) h > C21 to C32 Aromatics	32.639	211111953	155.600 UG/MLm

SemiQuant Compounds - Not Calibrated on this Instrument

(f)=RT Delta > 1/2 Window (m)=manual int.

Quantitation Report (QT Reviewed)

Data Path : C:\Projects\Hawaii DOH\2. Laboratory Data\Alpha\Carbon Range Study\L2240634\TPH\NF TPH\  
Data File : f1708242234.D  
Signal(s) : FID1A.CH  
Acq On : 26 Aug 2022 2:34 am  
Operator : FID17:WR  
Sample : L2240634-15,42,,  
Misc : WG1679263,WG1676458,ICAL18753  
ALS Vial : 17 Sample Multiplier: 1

Integration File: autoint1.e  
Quant Time: Oct 27 13:34:52 2022  
Quant Method : C:\Projects\Hawaii DOH\2. Laboratory Data\Alpha\Carbon Range Study\L2240634\TPH\NF TPH\NF TPH  
Quant Title : FID Forensics  
QLast Update : Fri Sep 23 15:53:13 2022  
Response via : Initial Calibration  
Integrator: ChemStation 6890 Scale Mode: Large solvent peaks clipped

Volume Inj. :  
Signal Phase :  
Signal Info :

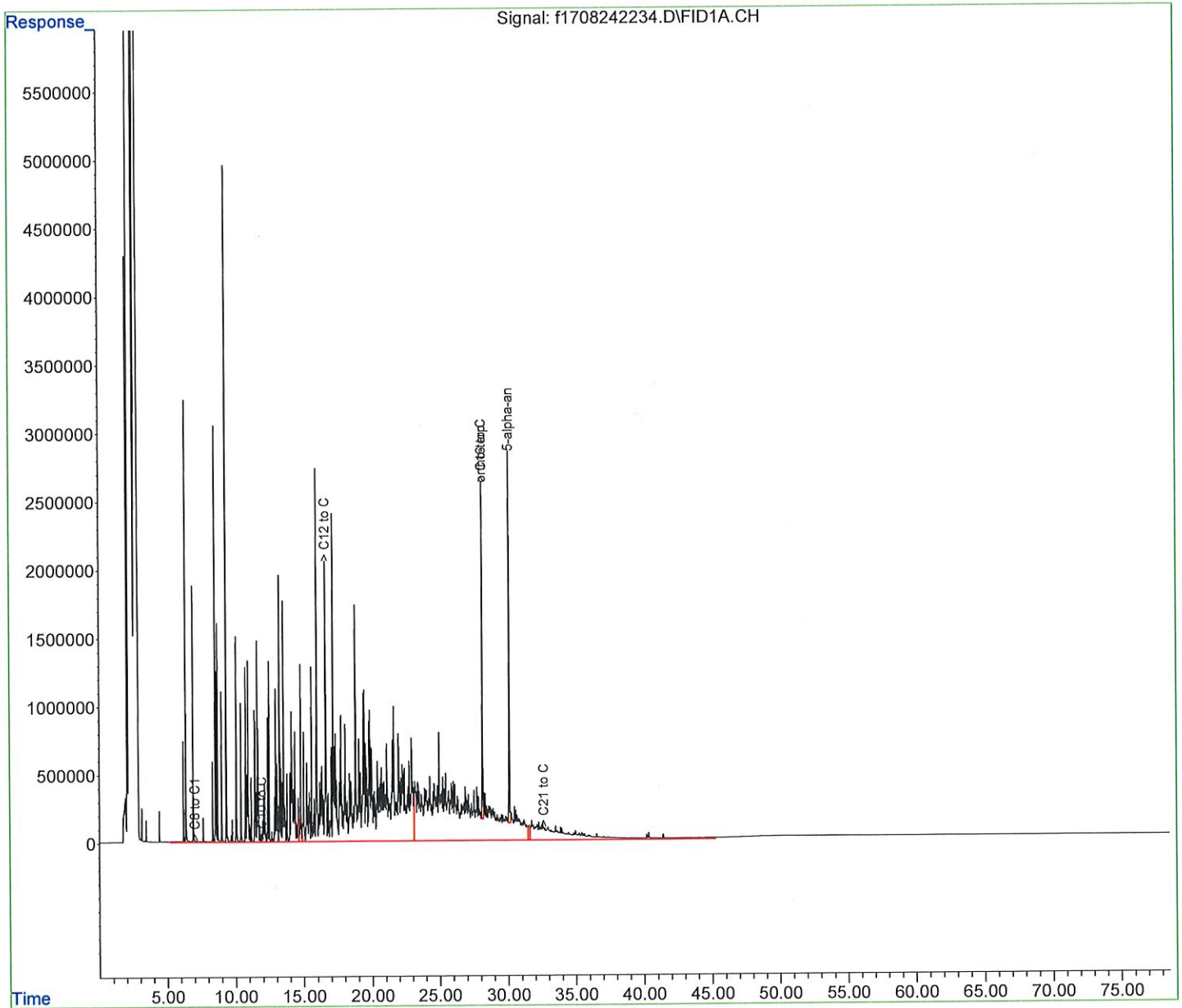

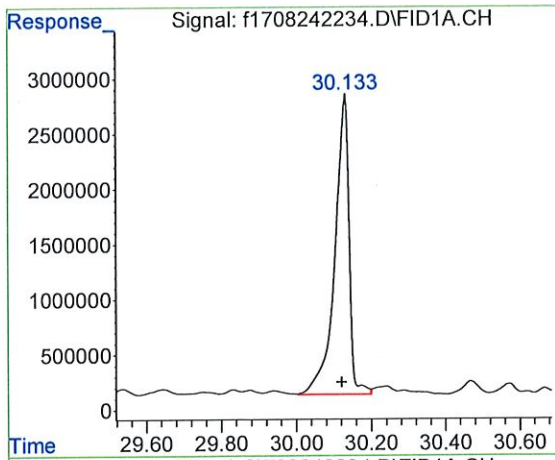

#1 5-alpha-androstane  
 R.T.: 30.133 min  
 Delta R.T.: 0.011 min  
 Response: 72014007  
 Conc: 50.00 ug/mL m

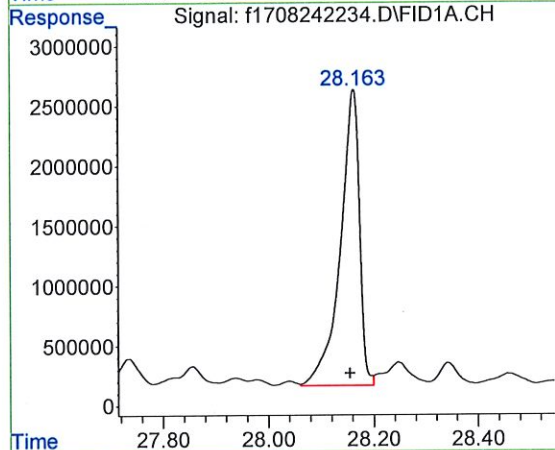

#2 ortho-terphenyl  
 R.T.: 28.163 min  
 Delta R.T.: 0.007 min  
 Response: 61848218  
 Conc: 41.08 ug/mL m

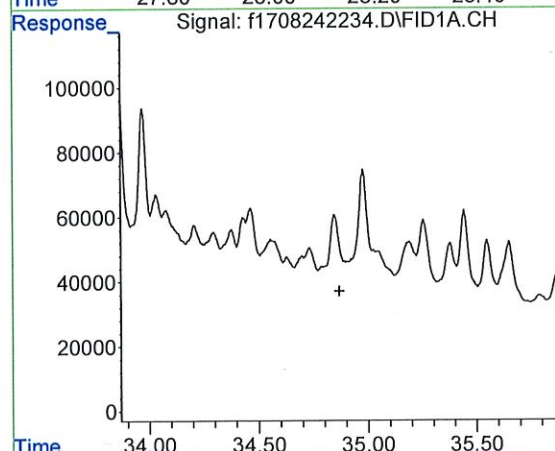

#3 d50-Tetracosane  
 R.T.: 0.000 min  
 Exp R.T. : 34.869 min  
 Response: 0  
 Conc: N.D.

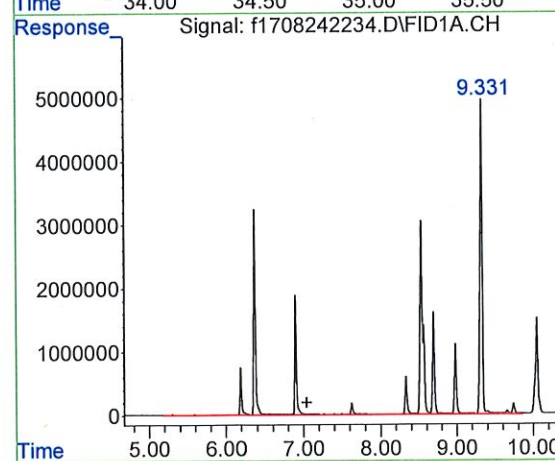

#9 > C8 to C10 Aromatics  
 R.T.: 7.038 min  
 Delta R.T.: 0.000 min  
 Response: 341284260  
 Conc: 251.54 UG/ML m

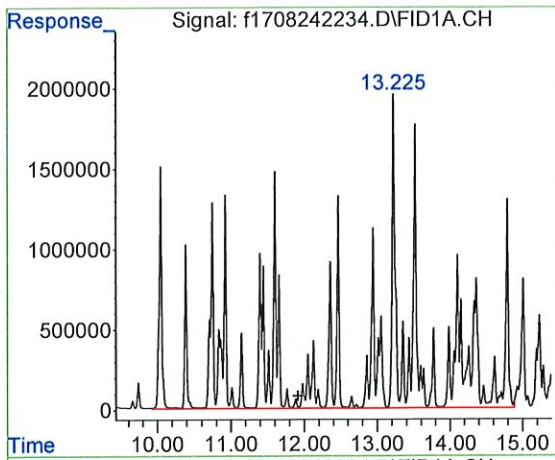

#10 > C10 to C12 Aromatics

R.T.: 11.919 min  
 Delta R.T.: 0.000 min  
 Response: 641781980  
 Conc: 473.02 UG/ML m

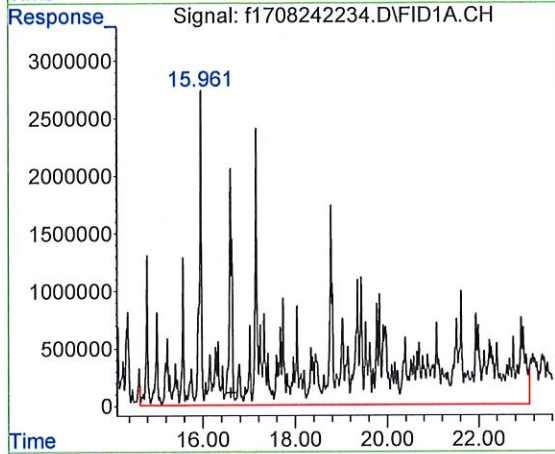

#11 > C12 to C16 Aromatics

R.T.: 16.606 min  
 Delta R.T.: 0.000 min  
 Response: 1670378414  
 Conc: 1231.15 UG/ML m

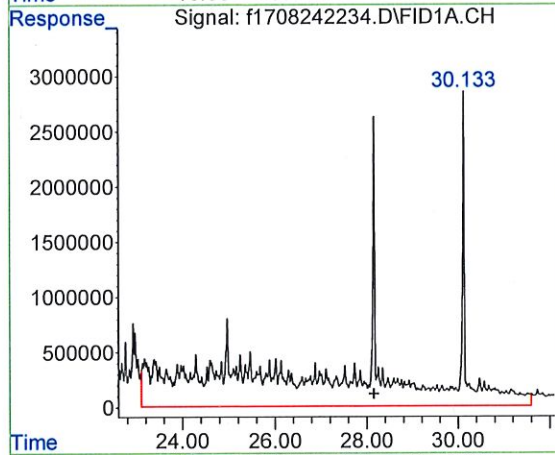

#12 > C16 to C21 Aromatics

R.T.: 28.155 min  
 Delta R.T.: 0.000 min  
 Response: 1143684784  
 Conc: 842.95 UG/ML m

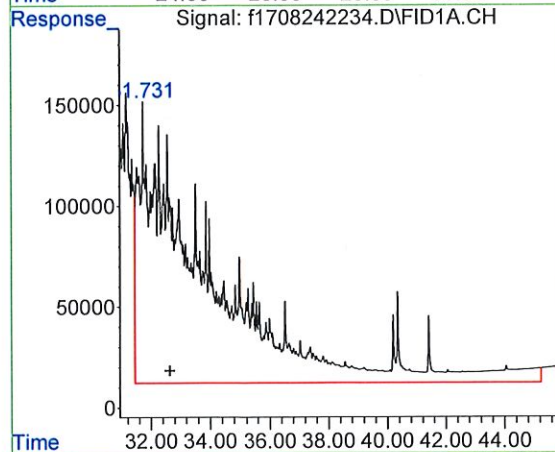

#13 > C21 to C32 Aromatics

R.T.: 32.639 min  
 Delta R.T.: 0.000 min  
 Response: 211111953  
 Conc: 155.60 UG/ML m

Quantitation Report (QT Reviewed)

Data Path : C:\Projects\Hawaii DOH\2. Laboratory Data\Alpha\Carbon Range Study\L2240634\TPH\NF TPH  
 Data File : f1708242236.D  
 Signal(s) : FID1A.CH  
 Acq On : 26 Aug 2022 4:05 am  
 Operator : FID17:WR  
 Sample : L2240634-18,42,,  
 Misc : WG1679263,WG1676458,ICAL18753  
 ALS Vial : 18 Sample Multiplier: 1

Integration File: autoint1.e  
 Quant Time: Oct 23 15:49:40 2022  
 Quant Method : C:\Projects\Hawaii DOH\2. Laboratory Data\Alpha\Carbon Range Study\L2240634\TPH\NF TPH\NF TPH  
 Quant Title : FID Forensics  
 QLast Update : Fri Sep 23 15:53:13 2022  
 Response via : Initial Calibration  
 Integrator: ChemStation 6890 Scale Mode: Large solvent peaks clipped

Volume Inj. :  
 Signal Phase :  
 Signal Info :

Compound	R.T.	Response	Conc Units
<u>Internal Standards</u>			
1) l 5-alpha-androstane	30.121	60909812	50.000 ug/mLm
<u>System Monitoring Compounds</u>			
2) s ortho-terphenyl	28.160	71948260	56.503 ug/mLm
Spiked Amount 50.000 Range 50 - 130 Recovery = 113.01%			
<u>Target Compounds</u>			
9) h > C8 to C10 Aromatics	7.038	173518306	151.207 UG/MLm
10) h > C10 to C12 Aromatics	11.919	1281830918	1117.008 UG/MLm
11) h > C12 to C16 Aromatics	16.606	2078425171	1811.174 UG/MLm
12) h > C16 to C21 Aromatics	28.155	40151719	34.989 UG/MLm
13) h > C21 to C32 Aromatics	32.639	35406944	30.854 UG/MLm

SemiQuant Compounds - Not Calibrated on this Instrument

(f)=RT Delta > 1/2 Window

(m)=manual int.

Quantitation Report (QT Reviewed)

Data Path : C:\Projects\Hawaii DOH\2. Laboratory Data\Alpha\Carbon Range Study\L2240634\TPH\NF TPH\  
Data File : f1708242236.D  
Signal(s) : FID1A.CH  
Acq On : 26 Aug 2022 4:05 am  
Operator : FID17:WR  
Sample : L2240634-18,42,,  
Misc : WG1679263,WG1676458,ICAL18753  
ALS Vial : 18 Sample Multiplier: 1

Integration File: autoint1.e  
Quant Time: Oct 23 15:49:40 2022  
Quant Method : C:\Projects\Hawaii DOH\2. Laboratory Data\Alpha\Carbon Range Study\L2240634\TPH\NF TPH\  
Quant Title : FID Forensics  
QLast Update : Fri Sep 23 15:53:13 2022  
Response via : Initial Calibration  
Integrator: ChemStation 6890 Scale Mode: Large solvent peaks clipped

Volume Inj. :  
Signal Phase :  
Signal Info :

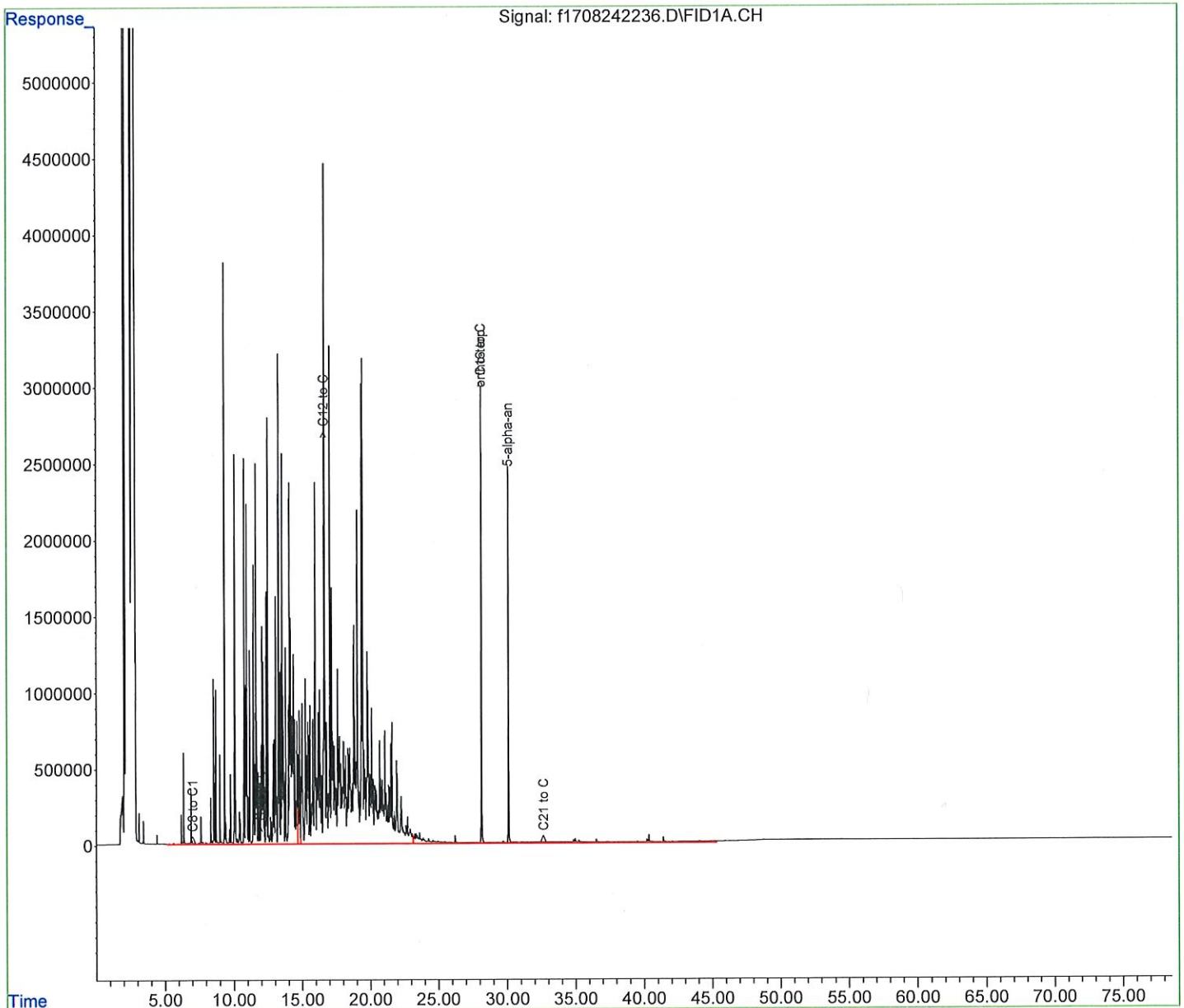

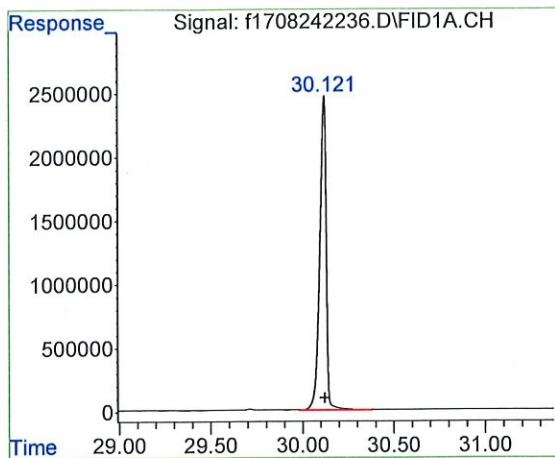

#1 5-alpha-androstane  
 R.T.: 30.121 min  
 Delta R.T.: 0.000 min  
 Response: 60909812  
 Conc: 50.00 ug/mL m

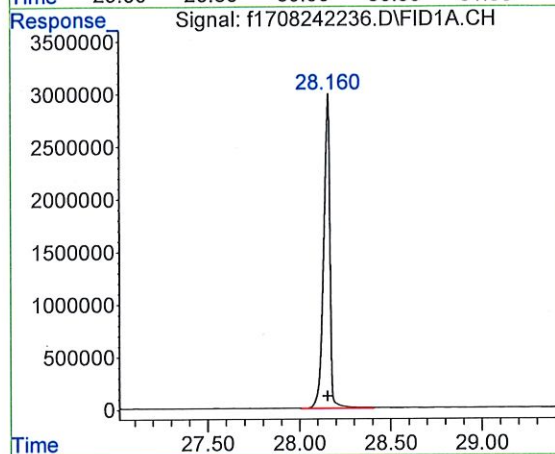

#2 ortho-terphenyl  
 R.T.: 28.160 min  
 Delta R.T.: 0.005 min  
 Response: 71948260  
 Conc: 56.50 ug/mL m

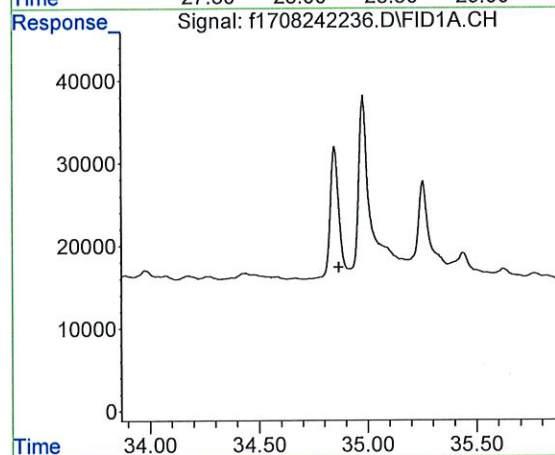

#3 d50-Tetracosane  
 R.T.: 0.000 min  
 Exp R.T. : 34.869 min  
 Response: 0  
 Conc: N.D.

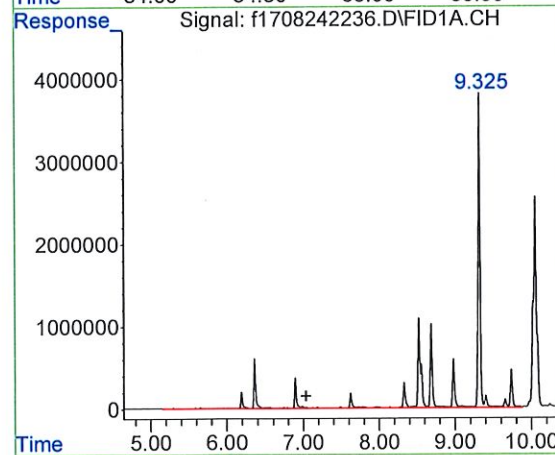

#9 > C8 to C10 Aromatics  
 R.T.: 7.038 min  
 Delta R.T.: 0.000 min  
 Response: 173518306  
 Conc: 151.21 UG/ML m

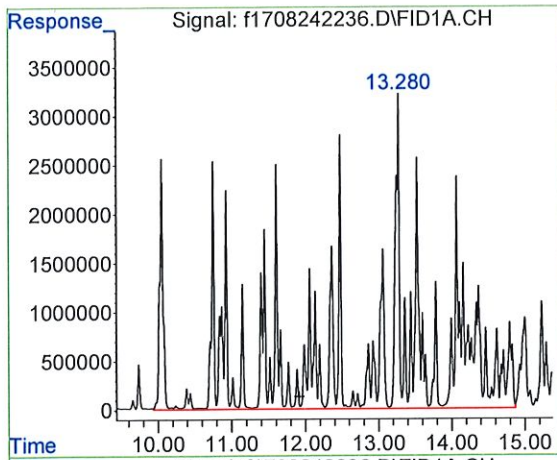

#10 > C10 to C12 Aromatics

R.T.: 11.919 min  
 Delta R.T.: 0.000 min  
 Response: 1281830918  
 Conc: 1117.01 UG/ML m

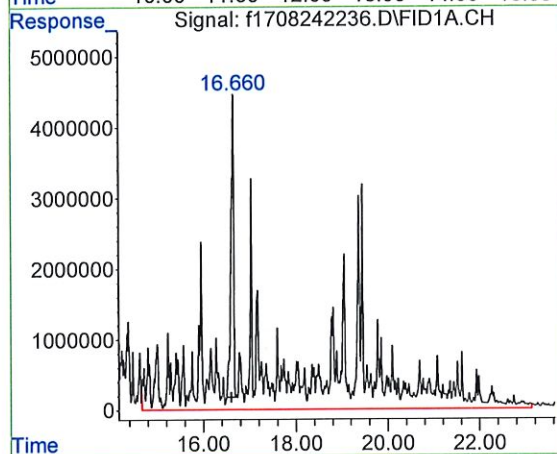

#11 > C12 to C16 Aromatics

R.T.: 16.606 min  
 Delta R.T.: 0.000 min  
 Response: 2078425171  
 Conc: 1811.17 UG/ML m

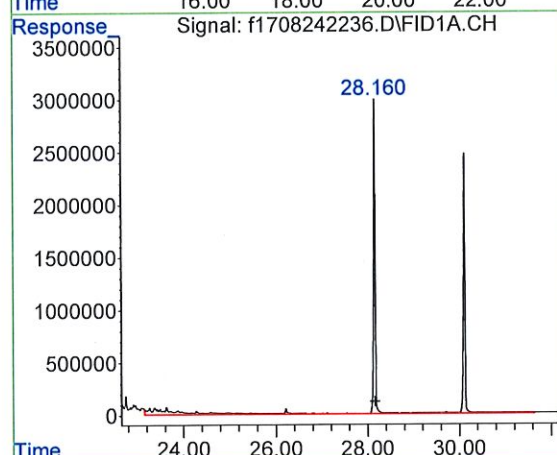

#12 > C16 to C21 Aromatics

R.T.: 28.155 min  
 Delta R.T.: 0.000 min  
 Response: 40151719  
 Conc: 34.99 UG/ML m

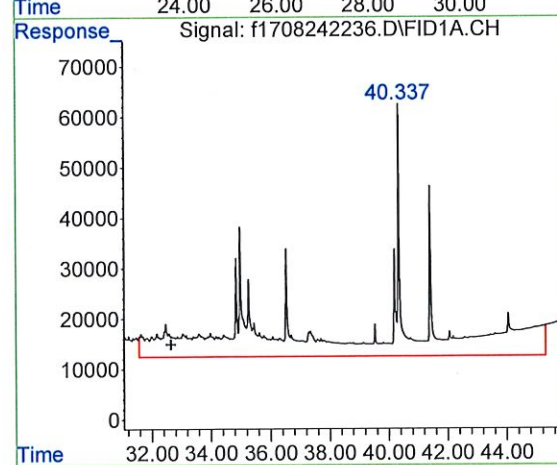

#13 > C21 to C32 Aromatics

R.T.: 32.639 min  
 Delta R.T.: 0.000 min  
 Response: 35406944  
 Conc: 30.85 UG/ML m



Quantitation Report (QT Reviewed)

Data Path : C:\Projects\Hawaii DOH\2. Laboratory Data\Alpha\Carbon Range Study\L2240634\TPH\NF TPH\  
Data File : f1708242238.D  
Signal(s) : FID1A.CH  
Acq On : 26 Aug 2022 5:35 am  
Operator : FID17:WR  
Sample : L2240634-21,42,,  
Misc : WG1679263,WG1676458,ICAL18753  
ALS Vial : 19 Sample Multiplier: 1

Integration File: autoint1.e  
Quant Time: Oct 23 15:56:29 2022  
Quant Method : C:\Projects\Hawaii DOH\2. Laboratory Data\Alpha\Carbon Range Study\L2240634\TPH\NF TPH\NF TPH (   
Quant Title : FID Forensics  
QLast Update : Fri Sep 23 15:53:13 2022  
Response via : Initial Calibration  
Integrator: ChemStation 6890 Scale Mode: Large solvent peaks clipped

Volume Inj. :  
Signal Phase :  
Signal Info :

Compound	R.T.	Response	Conc Units
Internal Standards			
1) I 5-alpha-androstane	30.122	67563072	50.000 ug/mLm
System Monitoring Compounds			
2) s ortho-terphenyl	28.155	63783057	45.158 ug/mLm
Spiked Amount	50.000	Range 50 - 130	Recovery = 90.32%
Target Compounds			
9) h > C8 to C10 Aromatics	7.038	772399920	606.800 UG/MLm
10) h > C10 to C12 Aromatics	11.919	996145040	782.575 UG/MLm
11) h > C12 to C16 Aromatics	16.606	1867860170	1467.398 UG/MLm
12) h > C16 to C21 Aromatics	28.155	148792599	116.892 UG/MLm
13) h > C21 to C32 Aromatics	32.639	26988282	21.202 UG/MLm

SemiQuant Compounds - Not Calibrated on this Instrument

(f)=RT Delta > 1/2 Window (m)=manual int.

Quantitation Report (QT Reviewed)

Data Path : C:\Projects\Hawaii DOH\2. Laboratory Data\Alpha\Carbon Range Study\L2240634\TPH\NF TPH\  
Data File : f1708242238.D  
Signal(s) : FID1A.CH  
Acq On : 26 Aug 2022 5:35 am  
Operator : FID17:WR  
Sample : L2240634-21,42,,  
Misc : WG1679263,WG1676458,ICAL18753  
ALS Vial : 19 Sample Multiplier: 1

Integration File: autoint1.e  
Quant Time: Oct 23 15:56:29 2022  
Quant Method : C:\Projects\Hawaii DOH\2. Laboratory Data\Alpha\Carbon Range Study\L2240634\TPH\NF TPH\  
Quant Title : FID Forensics  
QLast Update : Fri Sep 23 15:53:13 2022  
Response via : Initial Calibration  
Integrator: ChemStation 6890 Scale Mode: Large solvent peaks clipped

Volume Inj. :  
Signal Phase :  
Signal Info :

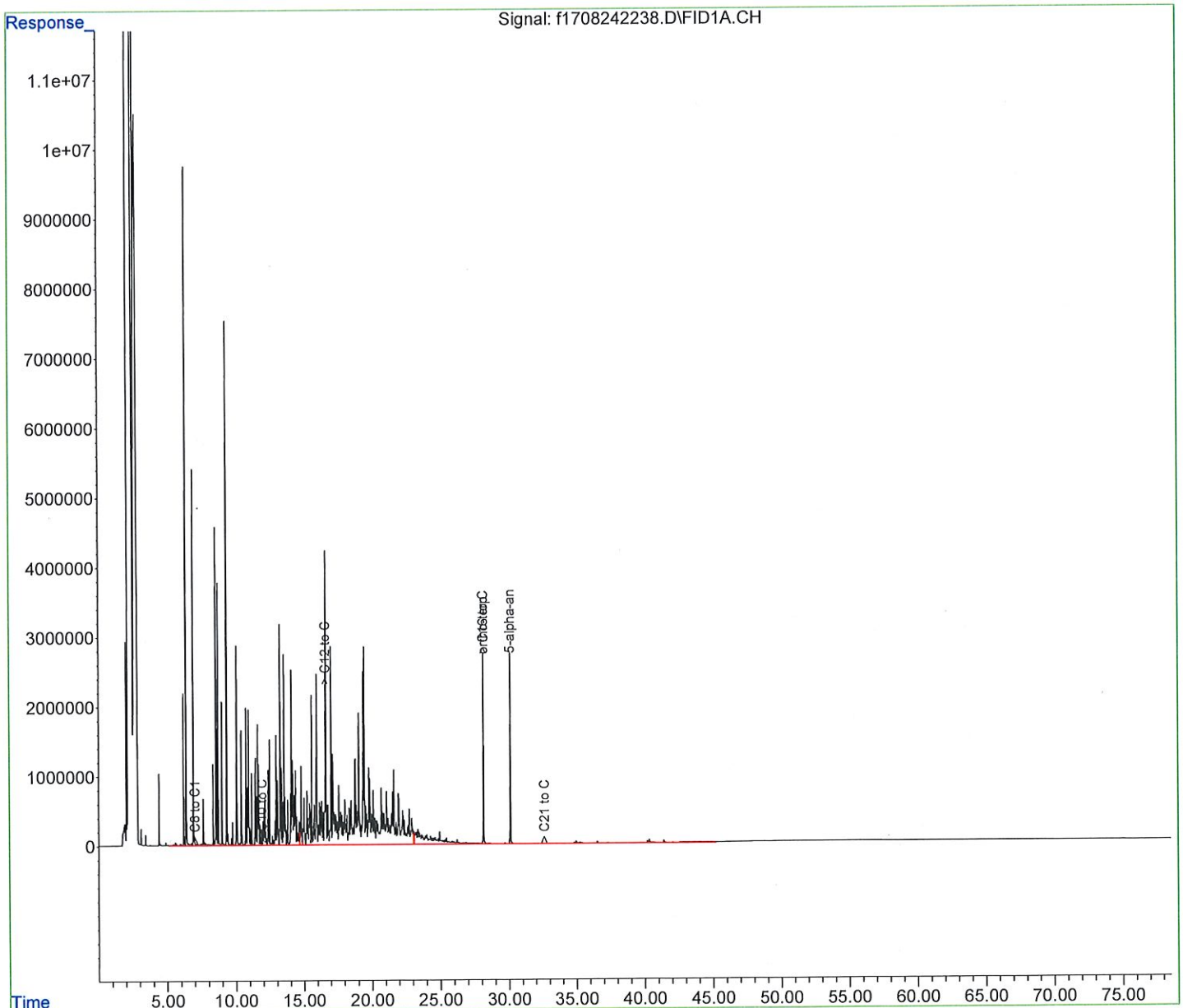

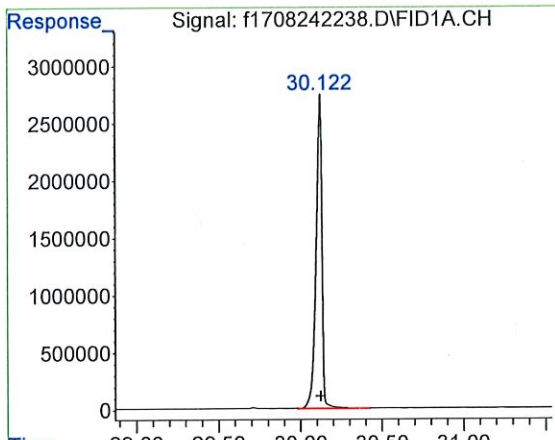

#1 5-alpha-androstane  
 R.T.: 30.122 min  
 Delta R.T.: 0.000 min  
 Response: 67563072  
 Conc: 50.00 ug/mL m

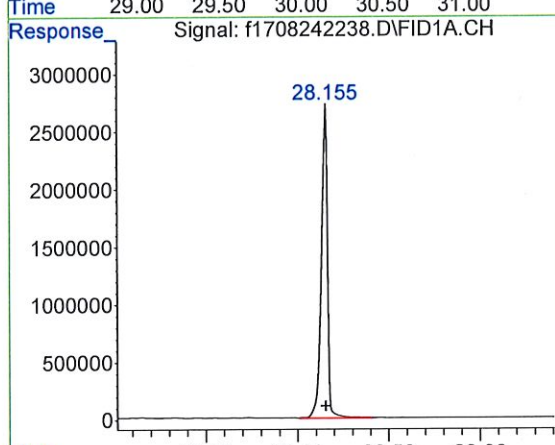

#2 ortho-terphenyl  
 R.T.: 28.155 min  
 Delta R.T.: 0.000 min  
 Response: 63783057  
 Conc: 45.16 ug/mL m

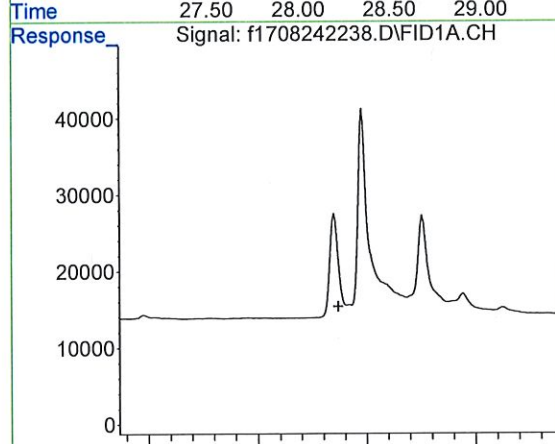

#3 d50-Tetracosane  
 R.T.: 0.000 min  
 Exp R.T. : 34.869 min  
 Response: 0  
 Conc: N.D.

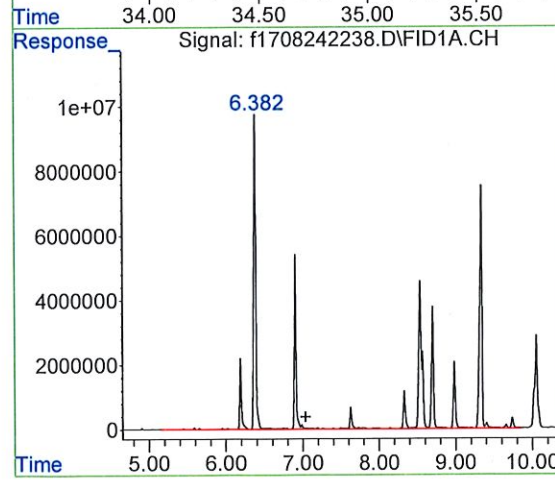

#9 > C8 to C10 Aromatics  
 R.T.: 7.038 min  
 Delta R.T.: 0.000 min  
 Response: 772399920  
 Conc: 606.80 UG/ML m

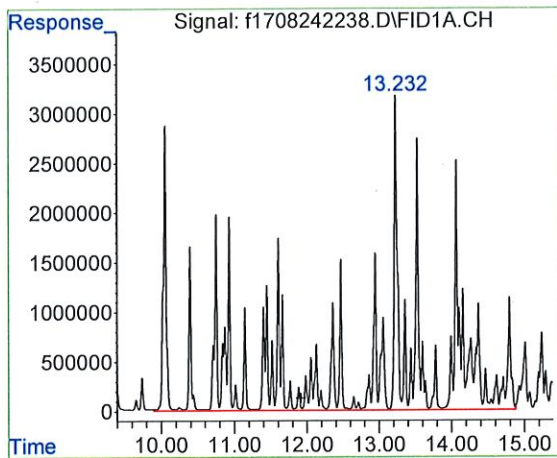

#10 > C10 to C12 Aromatics

R.T.: 11.919 min  
 Delta R.T.: 0.000 min  
 Response: 996145040  
 Conc: 782.58 UG/ML m

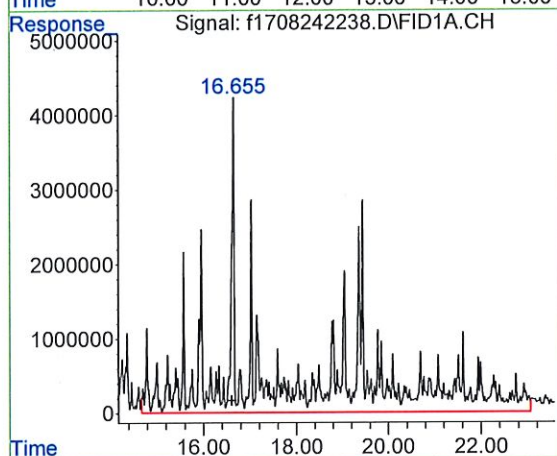

#11 > C12 to C16 Aromatics

R.T.: 16.606 min  
 Delta R.T.: 0.000 min  
 Response: 1867860170  
 Conc: 1467.40 UG/ML m

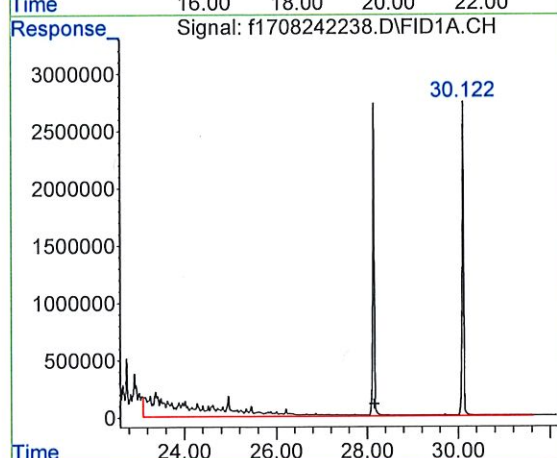

#12 > C16 to C21 Aromatics

R.T.: 28.155 min  
 Delta R.T.: 0.000 min  
 Response: 148792599  
 Conc: 116.89 UG/ML m

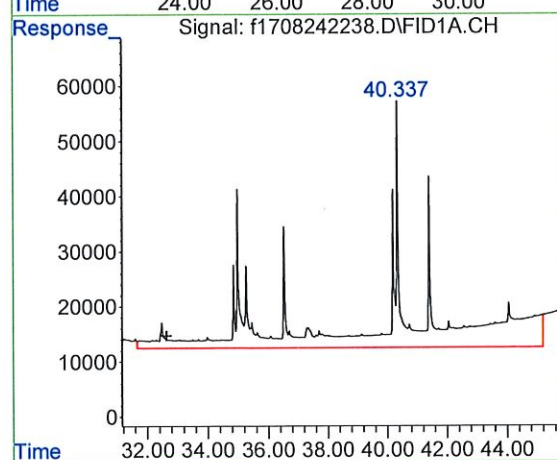

#13 > C21 to C32 Aromatics

R.T.: 32.639 min  
 Delta R.T.: 0.000 min  
 Response: 26988282  
 Conc: 21.20 UG/ML m

Quantitation Report (QT Reviewed)

Data Path : C:\Projects\Hawaii DOH\2. Laboratory Data\Alpha\Carbon Range Study\L2240634\TPH\NF TPH\  
Data File : f1708242240.D  
Signal(s) : FID1A.CH  
Acq On : 26 Aug 2022 7:05 am  
Operator : FID17:WR  
Sample : L2240634-27,42,,  
Misc : WG1679263,WG1676458,ICAL18753  
ALS Vial : 20 Sample Multiplier: 1

Integration File: autoint1.e  
Quant Time: Oct 23 16:11:48 2022  
Quant Method : C:\Projects\Hawaii DOH\2. Laboratory Data\Alpha\Carbon Range Study\L2240634\TPH\NF TPH\NF TPH (   
Quant Title : FID Forensics  
QLast Update : Fri Sep 23 15:53:13 2022  
Response via : Initial Calibration  
Integrator: ChemStation 6890 Scale Mode: Large solvent peaks clipped

Volume Inj. :  
Signal Phase :  
Signal Info :

Compound	R.T.	Response	Conc Units
Internal Standards			
1) I 5-alpha-androstane	30.126	71294132	50.000 ug/mLm
System Monitoring Compounds			
2) s ortho-terphenyl	28.160	69721607	46.779 ug/mLm
Spiked Amount	50.000	Range 50 - 130	Recovery = 93.56%
Target Compounds			
9) h > C8 to C10 Aromatics	7.038	8607615	6.408 UG/MLm
10) h > C10 to C12 Aromatics	11.919	96151579	71.584 UG/MLm
11) h > C12 to C16 Aromatics	16.606	420653648	313.173 UG/MLm
12) h > C16 to C21 Aromatics	28.155	516620976	384.619 UG/MLm
13) h > C21 to C32 Aromatics	32.639	1191979219	887.417 UG/MLm

SemiQuant Compounds - Not Calibrated on this Instrument

(f)=RT Delta > 1/2 Window (m)=manual int.

Quantitation Report (QT Reviewed)

Data Path : C:\Projects\Hawaii DOH\2. Laboratory Data\Alpha\Carbon Range Study\L2240634\TPH\NF TPH\  
Data File : f1708242240.D  
Signal(s) : FID1A.CH  
Acq On : 26 Aug 2022 7:05 am  
Operator : FID17:WR  
Sample : L2240634-27,42,,  
Misc : WG1679263,WG1676458,ICAL18753  
ALS Vial : 20 Sample Multiplier: 1

Integration File: autoint1.e  
Quant Time: Oct 23 16:11:48 2022  
Quant Method : C:\Projects\Hawaii DOH\2. Laboratory Data\Alpha\Carbon Range Study\L2240634\TPH\NF TPH\NF TPH  
Quant Title : FID Forensics  
QLast Update : Fri Sep 23 15:53:13 2022  
Response via : Initial Calibration  
Integrator: ChemStation 6890 Scale Mode: Large solvent peaks clipped

Volume Inj. :  
Signal Phase :  
Signal Info :

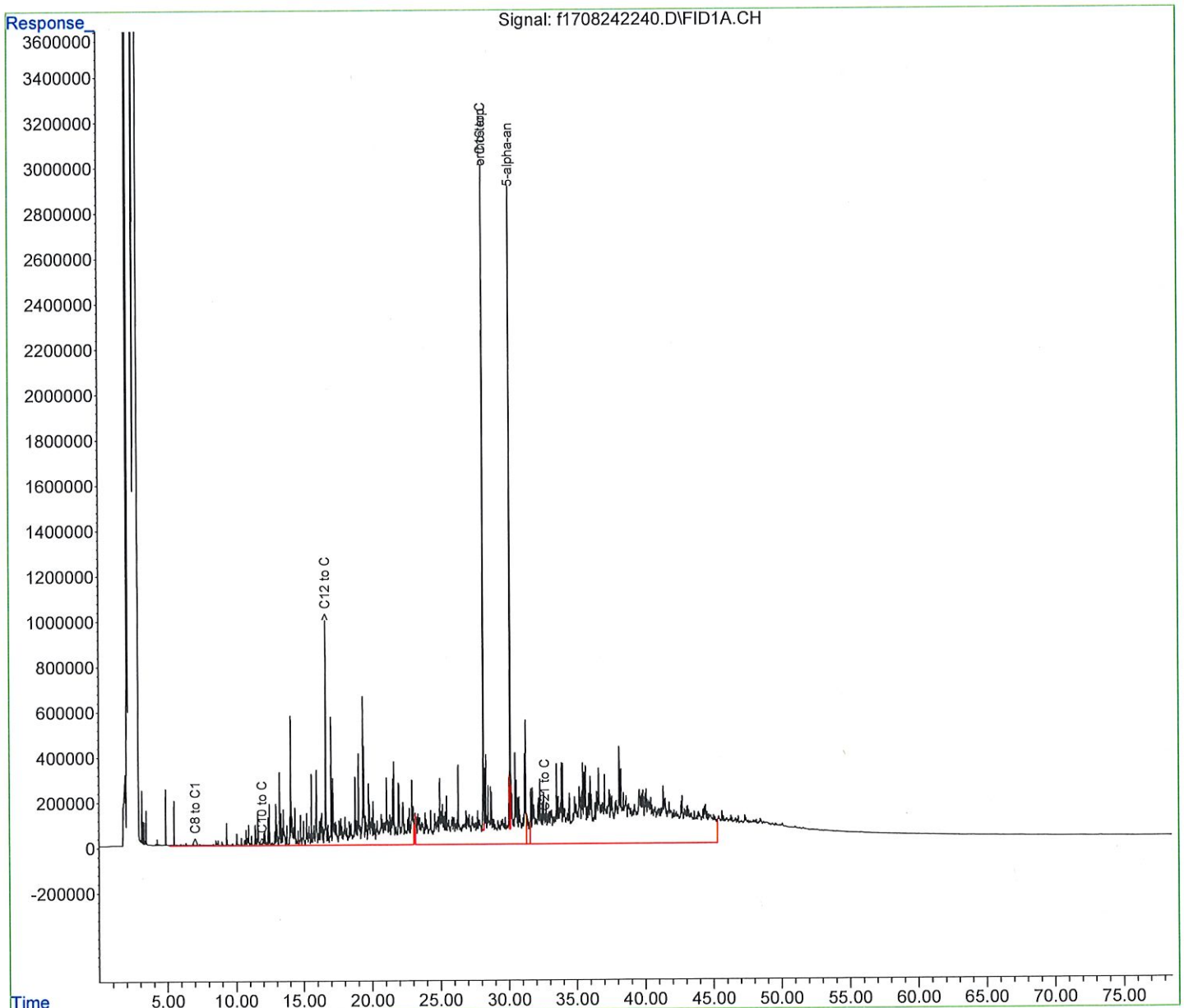

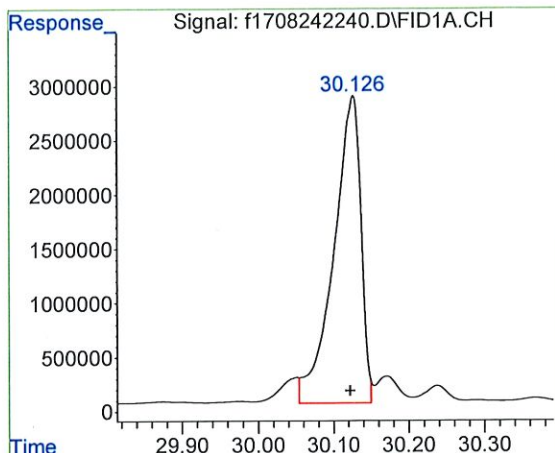

#1 5-alpha-androstane  
 R.T.: 30.126 min  
 Delta R.T.: 0.004 min  
 Response: 71294132  
 Conc: 50.00 ug/mL m

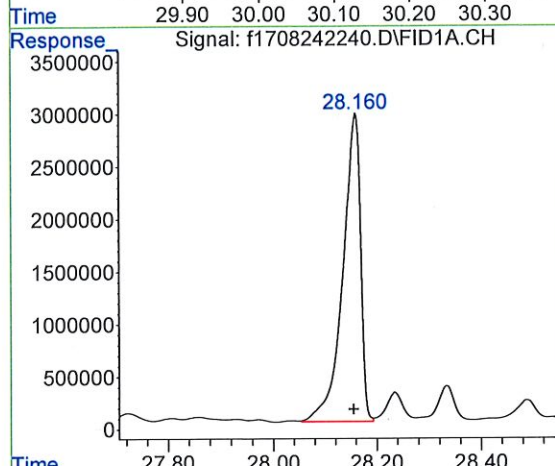

#2 ortho-terphenyl  
 R.T.: 28.160 min  
 Delta R.T.: 0.004 min  
 Response: 69721607  
 Conc: 46.78 ug/mL m

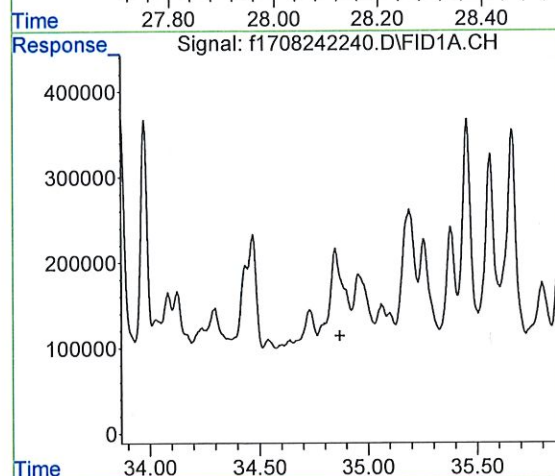

#3 d50-Tetracosane  
 R.T.: 0.000 min  
 Exp R.T. : 34.869 min  
 Response: 0  
 Conc: N.D.

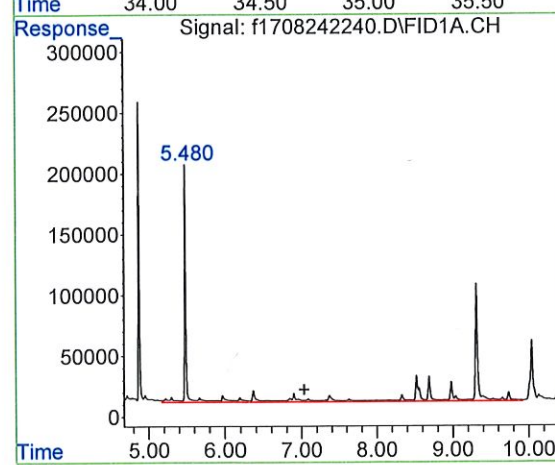

#9 > C8 to C10 Aromatics  
 R.T.: 7.038 min  
 Delta R.T.: 0.000 min  
 Response: 8607615  
 Conc: 6.41 UG/ML m

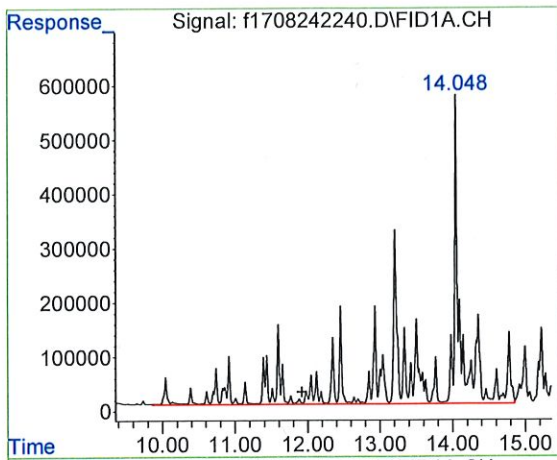

#10 > C10 to C12 Aromatics

R.T.: 11.919 min  
 Delta R.T.: 0.000 min  
 Response: 96151579  
 Conc: 71.58 UG/ML m

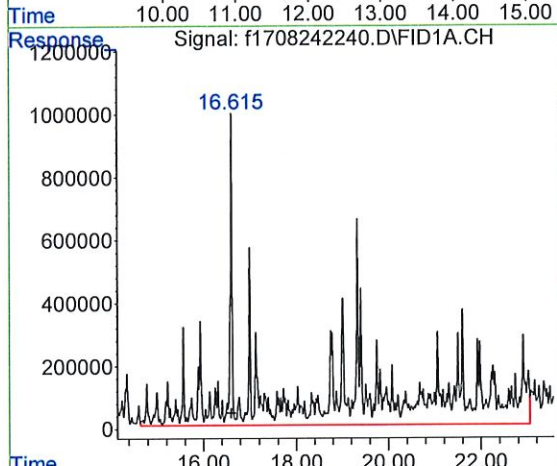

#11 > C12 to C16 Aromatics

R.T.: 16.606 min  
 Delta R.T.: 0.000 min  
 Response: 420653648  
 Conc: 313.17 UG/ML m

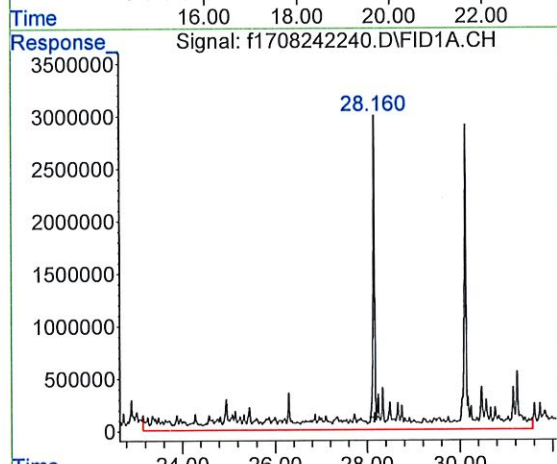

#12 > C16 to C21 Aromatics

R.T.: 28.155 min  
 Delta R.T.: 0.000 min  
 Response: 516620976  
 Conc: 384.62 UG/ML m

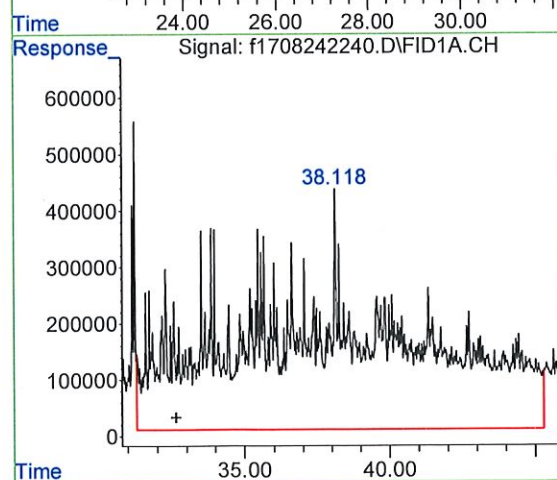

#13 > C21 to C32 Aromatics

R.T.: 32.639 min  
 Delta R.T.: 0.000 min  
 Response: 1191979219  
 Conc: 887.42 UG/ML m



Quantitation Report (QT Reviewed)

Data Path : C:\Projects\Hawaii DOH\2. Laboratory Data\Alpha\Carbon Range Study\L2240634\TPH\NF TPH\  
Data File : f1709062240.D  
Signal(s) : FID1A.CH  
Acq On : 07 Sep 2022 19:05 pm  
Operator : FID17:WR  
Sample : I2240634-34,42,,  
Misc : WG1684077,WG1682993,ICAL18753  
ALS Vial : 20 Sample Multiplier: 1

Integration File: autoint1.e  
Quant Time: Oct 26 14:32:01 2022  
Quant Method : C:\Projects\Hawaii DOH\2. Laboratory Data\Alpha\Carbon Range Study\L2240634\TPH\NF TPH\NF TPH (   
Quant Title : FID Forensics  
QLast Update : Sun Oct 23 16:14:30 2022  
Response via : Initial Calibration  
Integrator: ChemStation 6890 Scale Mode: Large solvent peaks clipped

Volume Inj. :  
Signal Phase :  
Signal Info :

Compound	R.T.	Response	Conc Units
Internal Standards			
1) I 5-alpha-androstane	30.078	56950357	50.000 ug/mLm
System Monitoring Compounds			
2) s ortho-terphenyl	28.115	61888011	51.982 ug/mLm
Spiked Amount 50.000 Range 50 - 130 Recovery = 103.96%			
Target Compounds			
9) h > C8 to C10 Aromatics	7.028	27220310	25.369 UG/MLm
10) h > C10 to C12 Aromatics	11.901	43832716	40.852 UG/MLm
11) h > C12 to C16 Aromatics	16.582	60866518	56.728 UG/MLm
12) h > C16 to C21 Aromatics	28.115	82212863	76.622 UG/MLm
13) h > C21 to C32 Aromatics	32.591	741457907	691.040 UG/MLm

SemiQuant Compounds - Not Calibrated on this Instrument

(f)=RT Delta > 1/2 Window (m)=manual int.

Quantitation Report (QT Reviewed)

Data Path : C:\Projects\Hawaii DOH\2. Laboratory Data\Alpha\Carbon Range Study\L2240634\TPH\NF TPH\  
Data File : f1709062240.D  
Signal(s) : FID1A.CH  
Acq On : 07 Sep 2022 19:05 pm  
Operator : FID17:WR  
Sample : I2240634-34,42,,  
Misc : WG1684077,WG1682993,ICAL18753  
ALS Vial : 20 Sample Multiplier: 1

Integration File: autoint1.e  
Quant Time: Oct 26 14:32:01 2022  
Quant Method : C:\Projects\Hawaii DOH\2. Laboratory Data\Alpha\Carbon Range Study\L2240634\TPH\NF TPH\NF TPH  
Quant Title : FID Forensics  
QLast Update : Sun Oct 23 16:14:30 2022  
Response via : Initial Calibration  
Integrator: ChemStation 6890 Scale Mode: Large solvent peaks clipped

Volume Inj. :  
Signal Phase :  
Signal Info :

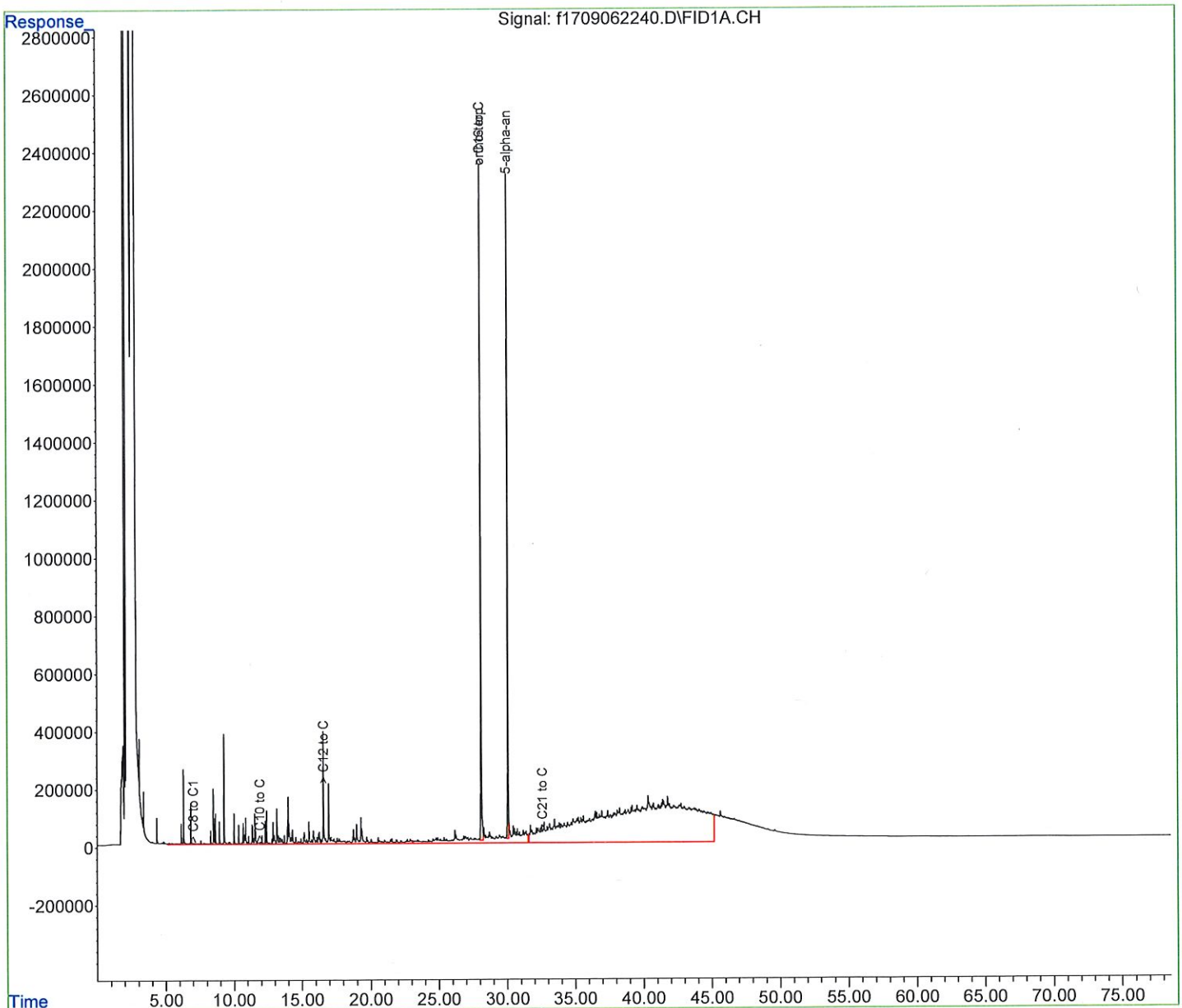

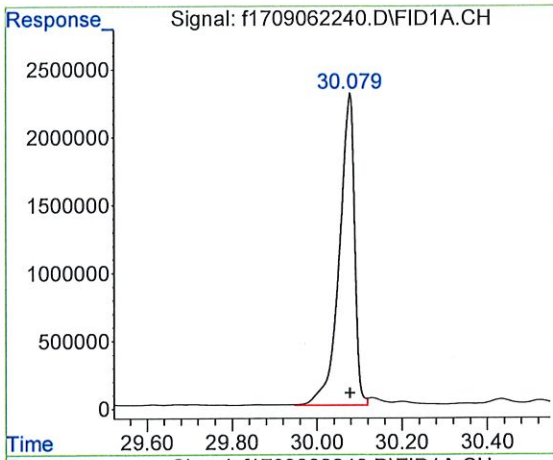

#1 5-alpha-androstane  
 R.T.: 30.078 min  
 Delta R.T.: 0.000 min  
 Response: 56950357  
 Conc: 50.00 ug/mL m

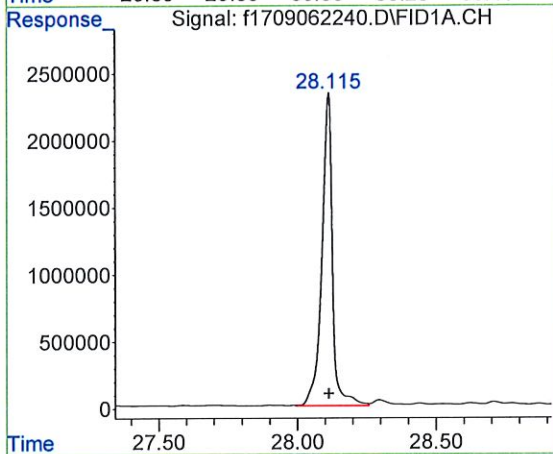

#2 ortho-terphenyl  
 R.T.: 28.115 min  
 Delta R.T.: 0.000 min  
 Response: 61888011  
 Conc: 51.98 ug/mL m

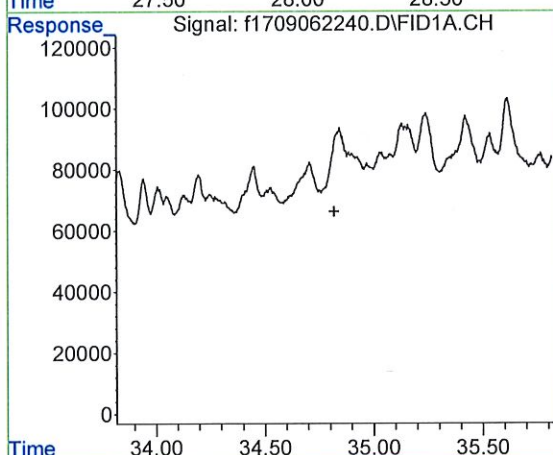

#3 d50-Tetracosane  
 R.T.: 0.000 min  
 Exp R.T. : 34.818 min  
 Response: 0  
 Conc: N.D.

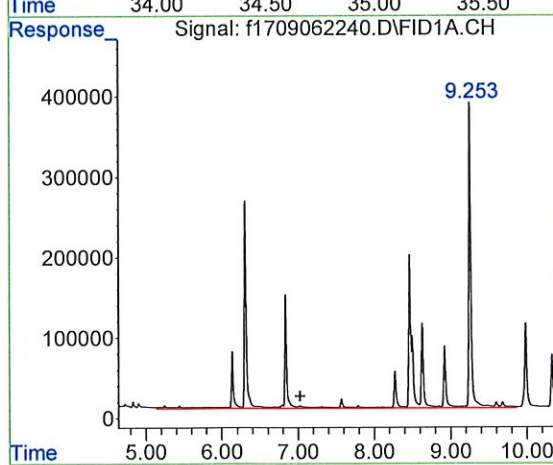

#9 > C8 to C10 Aromatics  
 R.T.: 7.028 min  
 Delta R.T.: 0.000 min  
 Response: 27220310  
 Conc: 25.37 UG/ML m

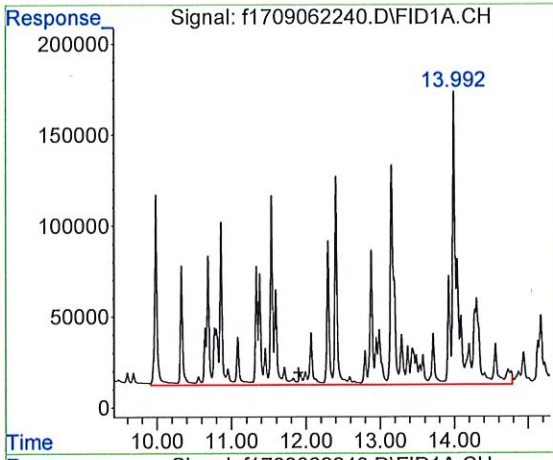

#10 > C10 to C12 Aromatics

R.T.: 11.901 min  
 Delta R.T.: 0.000 min  
 Response: 43832716  
 Conc: 40.85 UG/ML m

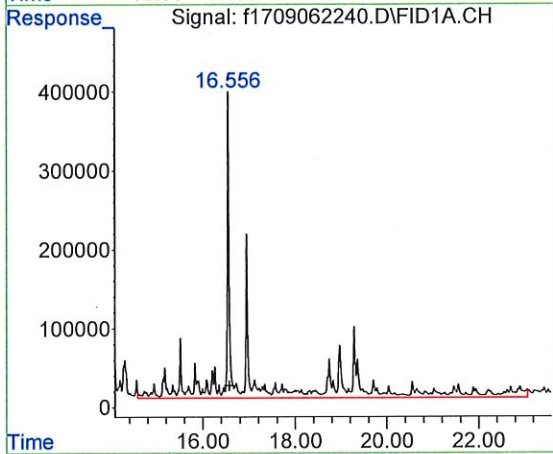

#11 > C12 to C16 Aromatics

R.T.: 16.582 min  
 Delta R.T.: 0.000 min  
 Response: 60866518  
 Conc: 56.73 UG/ML m

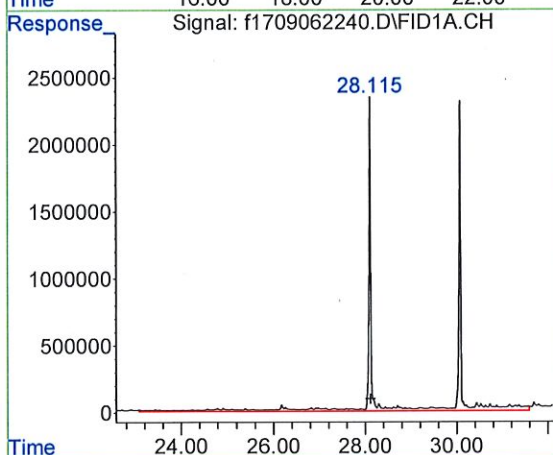

#12 > C16 to C21 Aromatics

R.T.: 28.115 min  
 Delta R.T.: 0.000 min  
 Response: 82212863  
 Conc: 76.62 UG/ML m

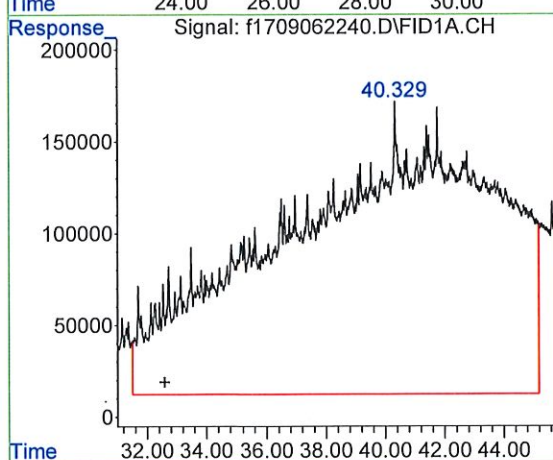

#13 > C21 to C32 Aromatics

R.T.: 32.591 min  
 Delta R.T.: 0.000 min  
 Response: 741457907  
 Conc: 691.04 UG/ML m



## ANALYTICAL REPORT

Lab Number:	L2240634
Client:	NewFields 300 Ledgewood Place Suite 305 Rockland, MA 02370
ATTN:	Eric Litman
Phone:	(781) 681-5040
Project Name:	HAWAII DOH - FINGERPRINTING
Project Number:	Not Specified
Report Date:	09/08/22

The original project report/data package is held by Alpha Analytical. This report/data package is paginated and should be reproduced only in its entirety. Alpha Analytical holds no responsibility for results and/or data that are not consistent with the original.

Certifications & Approvals: MA (M-MA030), NH NELAP (2062), CT (PH-0141), DoD (L2474), FL (E87814), IL (200081), LA (85084), ME (MA00030), MD (350), NJ (MA015), NY (11627), NC (685), OH (CL106), PA (68-02089), RI (LAO00299), TX (T104704419), VT (VT-0015), VA (460194), WA (C954), US Army Corps of Engineers, USDA (Permit #P330-17-00150), USFWS (Permit #206964).

---

320 Forbes Boulevard, Mansfield, MA 02048-1806  
508-822-9300 (Fax) 508-822-3288 800-624-9220 - [www.alphalab.com](http://www.alphalab.com)



Project Name: HAWAII DOH - FINGERPRINTING

Project Number: Not Specified

Lab Number: L2240634

Report Date: 09/08/22

Alpha Sample ID	Client ID	Matrix	Sample Location	Collection Date/Time	Receive Date
L2240634-01	GASOLINE 87	OIL	Not Specified	07/26/22 00:00	07/29/22
L2240634-02	GASOLINE 87 F1	OIL	Not Specified	07/26/22 00:00	07/29/22
L2240634-03	GASOLINE 87 F2	OIL	Not Specified	07/26/22 00:00	07/29/22
L2240634-04	GASOLINE 91	OIL	Not Specified	07/26/22 00:00	07/29/22
L2240634-05	GASOLINE 91 F1	OIL	Not Specified	07/26/22 00:00	07/29/22
L2240634-06	GASOLINE 91 F2	OIL	Not Specified	07/26/22 00:00	07/29/22
L2240634-07	GASOLINE 93	OIL	Not Specified	07/26/22 00:00	07/29/22
L2240634-08	GASOLINE 93 F1	OIL	Not Specified	07/26/22 00:00	07/29/22
L2240634-09	GASOLINE 93 F2	OIL	Not Specified	07/26/22 00:00	07/29/22
L2240634-10	HEATING FUEL	OIL	Not Specified	07/26/22 00:00	07/29/22
L2240634-11	HEATING FUEL F1	OIL	Not Specified	07/26/22 00:00	07/29/22
L2240634-12	HEATING FUEL F2	OIL	Not Specified	07/26/22 00:00	07/29/22
L2240634-13	ROAD DIESEL	OIL	Not Specified	07/26/22 00:00	07/29/22
L2240634-14	ROAD DIESEL F1	OIL	Not Specified	07/26/22 00:00	07/29/22
L2240634-15	ROAD DIESEL F2	OIL	Not Specified	07/26/22 00:00	07/29/22
L2240634-16	JP-5	OIL	Not Specified	07/26/22 00:00	07/29/22
L2240634-17	JP-5 F1	OIL	Not Specified	07/26/22 00:00	07/29/22
L2240634-18	JP-5 F2	OIL	Not Specified	07/26/22 00:00	07/29/22
L2240634-19	JP-8	OIL	Not Specified	07/26/22 00:00	07/29/22
L2240634-20	JP-8 F1	OIL	Not Specified	07/26/22 00:00	07/29/22
L2240634-21	JP-8 F2	OIL	Not Specified	07/26/22 00:00	07/29/22
L2240634-22	ASPHALT 1	OIL	Not Specified	07/26/22 00:00	07/29/22
L2240634-23	ASPHALT 1 F1	OIL	Not Specified	07/26/22 00:00	07/29/22
L2240634-24	ASPHALT 1 F2	OIL	Not Specified	07/26/22 00:00	07/29/22

<b>Alpha Sample ID</b>	<b>Client ID</b>	<b>Matrix</b>	<b>Sample Location</b>	<b>Collection Date/Time</b>	<b>Receive Date</b>
L2240634-25	BUNKER C	OIL	Not Specified	07/26/22 00:00	07/29/22
L2240634-26	BUNKER C F1	OIL	Not Specified	07/26/22 00:00	07/29/22
L2240634-27	BUNKER C F2	OIL	Not Specified	07/26/22 00:00	07/29/22
L2240634-28	JP-5 MEOH (0.5 MG/ML)	OIL	Not Specified	08/08/22 00:00	08/08/22
L2240634-29	JP-8 MEOH (0.5 MG/ML)	OIL	Not Specified	08/08/22 00:00	08/08/22
L2240634-30	JP-5 MEOH (20 MG/ML)	OIL	Not Specified	08/17/22 12:15	08/17/22
L2240634-31	JP-8 MEOH (20 MG/ML)	OIL	Not Specified	08/17/22 12:15	08/17/22
L2240634-32	WASTE OIL (AUTO)	OIL	Not Specified	07/26/22 00:00	07/29/22
L2240634-33	WASTE OIL (AUTO) F1	OIL	Not Specified	07/26/22 00:00	07/29/22
L2240634-34	WASTE OIL (AUTO) F2	OIL	Not Specified	07/26/22 00:00	07/29/22

**Project Name:** HAWAII DOH - FINGERPRINTING  
**Project Number:** Not Specified

**Lab Number:** L2240634  
**Report Date:** 09/08/22

### Case Narrative

The samples were received in accordance with the Chain of Custody and no significant deviations were encountered during the preparation or analysis unless otherwise noted. Sample Receipt, Container Information, and the Chain of Custody are located at the back of the report.

Results contained within this report relate only to the samples submitted under this Alpha Lab Number and meet NELAP requirements for all NELAP accredited parameters unless otherwise noted in the following narrative. The data presented in this report is organized by parameter (i.e. VOC, SVOC, etc.). Sample specific Quality Control data (i.e. Surrogate Spike Recovery) is reported at the end of the target analyte list for each individual sample, followed by the Laboratory Batch Quality Control at the end of each parameter. Tentatively Identified Compounds (TICs), if requested, are reported for compounds identified to be present and are not part of the method/program Target Compound List, even if only a subset of the TCL are being reported. If a sample was re-analyzed or re-extracted due to a required quality control corrective action and if both sets of data are reported, the Laboratory ID of the re-analysis or re-extraction is designated with an "R" or "RE", respectively.

When multiple Batch Quality Control elements are reported (e.g. more than one LCS), the associated samples for each element are noted in the grey shaded header line of each data table. Any Laboratory Batch, Sample Specific % recovery or RPD value that is outside the listed Acceptance Criteria is bolded in the report. In reference to questions H (CAM) or 4 (RCP) when "NO" is checked, the performance criteria for CAM and RCP methods allow for some quality control failures to occur and still be within method compliance. In these instances, the specific failure is not narrated but noted in the associated QC Outlier Summary Report, located directly after the Case Narrative. QC information is also incorporated in the Data Usability Assessment table (Format 11) of our Data Merger tool, where it can be reviewed in conjunction with the sample result, associated regulatory criteria and any associated data usability implications.

Soil/sediments, solids and tissues are reported on a dry weight basis unless otherwise noted. Definitions of all data qualifiers and acronyms used in this report are provided in the Glossary located at the back of the report.

**HOLD POLICY** - For samples submitted on hold, Alpha's policy is to hold samples (with the exception of Air canisters) free of charge for 21 calendar days from the date the project is completed. After 21 calendar days, we will dispose of all samples submitted including those put on hold unless you have contacted your Alpha Project Manager and made arrangements for Alpha to continue to hold the samples. Air canisters will be disposed after 3 business days from the date the project is completed.

Please contact Project Management at 800-624-9220 with any questions.

---



**Project Name:** HAWAII DOH - FINGERPRINTING  
**Project Number:** Not Specified

**Lab Number:** L2240634  
**Report Date:** 09/08/22

### Case Narrative (continued)

#### Report Submission

All non-detect (ND) or estimated concentrations (J-qualified) have been quantitated to the limit noted in the MDL column.

#### Volatile Organics

L2240634-01D, -04D, -07D, -10D, -13D, -25D, -30D, and -31D: The samples have elevated detection limits due to the dilution required by the elevated concentrations of target compounds in the samples.

L2240634-01D2, -04D2, -07D2, -13D2, -30D2, and -31D2: The samples were re-analyzed on dilution in order to quantitate the results within the calibration range. The result(s) should be considered estimated, and are qualified with an E flag, for any compound(s) that exceeded the calibration range in the initial analysis. The re-analysis was performed only for the compound(s) that exceeded the calibration range.

The WG1671854-6 Method Blank, associated with L2240634-01D2, -01D, -04D2, -04D, -07D2, -07D, -10D, -13D, -13D2, -22, and -25D, has concentrations below the reporting limits and "J" qualified. Associated field sample results are "B" qualified if the concentrations are less than 10x the concentrations in the blank.

The WG1677380-6 Method Blank, associated with L2240634-30D2, -30D, -31D2, -31D, and -32, has concentrations below the reporting limits and "J" qualified. Associated field sample results are "B" qualified if the concentrations are less than 10x the concentrations in the blank.

#### Petroleum Hydrocarbon Quantitation

The WG1676458-1 Method Blank, associated with L2240634-03, -06, -09, -12, -15, -18, -21, and -27, has a concentration above the reporting limit for TPH (C9-C44). Associated field sample results are "B" qualified if the concentrations are less than 10x the concentration in the blank.

#### VPH

L2240634-01D, -04D, -07D, -10D, -13D, -25D, -30D, -31D, and -32D: The sample has elevated detection limits due to the dilution required by the elevated concentrations of target compounds in the sample.

L2240634-01D, -04D, -07D, -10D, and -13D: The surrogate recoveries are below the acceptance criteria for

**Project Name:** HAWAII DOH - FINGERPRINTING  
**Project Number:** Not Specified

**Lab Number:** L2240634  
**Report Date:** 09/08/22

### Case Narrative (continued)

2,5-dibromotoluene-pid (0%) and 2,5-dibromotoluene-fid (0%) due to the dilution required to quantitate the sample. Re-extraction was not required; therefore, the results of the original analysis are reported.

L2240634-25D: The surrogate recoveries are outside the acceptance criteria for 2,5-dibromotoluene-pid (0%) and 2,5-dibromotoluene-fid (0%); however, the sample was not re-analyzed due to coelution with an unresolved complex mixture (UCM). A copy of the chromatogram is included as an attachment to this report. The results are not considered to be biased.

L2240634-32D: The surrogate recovery is outside the acceptance criteria for 2,5-dibromotoluene-fid (14%); however, the sample was not re-analyzed due to coelution with an obvious interference. A copy of the chromatogram is included as an attachment to this report.

WG1684889-6: The sample has elevated detection limits due to the dilution required by the elevated concentrations of target compounds in the sample.

WG1684889-6: The surrogate recoveries are below the acceptance criteria for 2,5-dibromotoluene-pid (0%) and 2,5-dibromotoluene-fid (0%) due to the dilution required to quantitate the sample. Re-extraction was not required; therefore, the results of the original analysis are reported.

I, the undersigned, attest under the pains and penalties of perjury that, to the best of my knowledge and belief and based upon my personal inquiry of those responsible for providing the information contained in this analytical report, such information is accurate and complete. This certificate of analysis is not complete unless this page accompanies any and all pages of this report.

Authorized Signature:

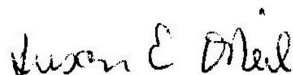

Susan O'Neil

Title: Technical Director/Representative

Date: 09/08/22

# ORGANICS

# VOLATILES

**Project Name:** HAWAII DOH - FINGERPRINTING**Lab Number:** L2240634**Project Number:** Not Specified**Report Date:** 09/08/22**SAMPLE RESULTS**

Lab ID: L2240634-01 D2

Date Collected: 07/26/22 00:00

Client ID: GASOLINE 87

Date Received: 07/29/22

Sample Location: Not Specified

Field Prep: Not Specified

Sample Depth:

Matrix: Oil

Analytical Method: 1,8260B(M)

Analytical Date: 08/04/22 02:47

Analyst: RY

Percent Solids: Results reported on an 'AS RECEIVED' basis.

Parameter	Result	Qualifier	Units	RL	MDL	Dilution Factor
<b>PIANO Volatile Organics by GC/MS - Mansfield Lab</b>						
Isopentane	37900		mg/kg	1890	703.	200
Pentane	30300		mg/kg	1890	588.	200
2-Methylpentane	26800		mg/kg	1890	607.	200
3-Methylpentane	17800		mg/kg	1890	366.	200
n-Hexane	26700		mg/kg	1890	550.	200
Methylcyclopentane	18800		mg/kg	1890	573.	200
Cyclohexane	12700		mg/kg	1890	544.	200
2-Methylhexane	14500		mg/kg	1890	440.	200
3-Methylhexane	14800		mg/kg	1890	496.	200
Isooctane	14900		mg/kg	1890	441.	200
Heptane	18700		mg/kg	1890	518.	200
Methylcyclohexane	14300		mg/kg	1890	402.	200
Toluene	50200		mg/kg	1890	273.	200
Ethylbenzene	11800		mg/kg	1890	204.	200
p/m-Xylene	46400		mg/kg	3770	531.	200
o-Xylene	16800		mg/kg	1890	290.	200
1-Methyl-3-Ethylbenzene	11900		mg/kg	1890	302.	200
1,2,4-Trimethylbenzene	19200		mg/kg	1890	413.	200

Surrogate	% Recovery	Qualifier	Acceptance Criteria
Dibromofluoromethane	124		70-130
Toluene-d8	112		70-130
4-Bromofluorobenzene	96		70-130

**Project Name:** HAWAII DOH - FINGERPRINTING**Lab Number:** L2240634**Project Number:** Not Specified**Report Date:** 09/08/22**SAMPLE RESULTS**

Lab ID: L2240634-01 D

Date Collected: 07/26/22 00:00

Client ID: GASOLINE 87

Date Received: 07/29/22

Sample Location: Not Specified

Field Prep: Not Specified

Sample Depth:

Matrix: Oil

Analytical Method: 1,8260B(M)

Analytical Date: 08/03/22 22:03

Analyst: RY

Percent Solids: Results reported on an 'AS RECEIVED' basis.

Parameter	Result	Qualifier	Units	RL	MDL	Dilution Factor
<b>PIANO Volatile Organics by GC/MS - Mansfield Lab</b>						
Isopentane	58500	E	mg/kg	94.3	35.2	10
1-Pentene	2220		mg/kg	94.3	29.2	10
2-Methyl-1-Butene	5550		mg/kg	94.3	31.0	10
Pentane	43500	E	mg/kg	94.3	29.4	10
trans-2-Pentene	6310		mg/kg	94.3	33.2	10
cis-2-Pentene	3660		mg/kg	94.3	24.7	10
Tertiary Butanol	ND		mg/kg	1180	382.	10
Cyclopentane	4880		mg/kg	94.3	24.5	10
2,3-Dimethylbutane	7760		mg/kg	94.3	38.9	10
2-Methylpentane	35800	E	mg/kg	94.3	30.4	10
Methyl tert butyl ether	ND		mg/kg	94.3	29.4	10
3-Methylpentane	22700	E	mg/kg	94.3	18.3	10
1-Hexene	820		mg/kg	94.3	27.1	10
n-Hexane	33300	E	mg/kg	94.3	27.5	10
Isopropyl Ether	ND		mg/kg	94.3	25.9	10
Ethyl-Tert-Butyl-Ether	ND		mg/kg	94.3	24.6	10
2,2-Dimethylpentane	1230		mg/kg	94.3	24.4	10
Methylcyclopentane	22200	E	mg/kg	94.3	28.7	10
2,4-Dimethylpentane	4700		mg/kg	94.3	24.8	10
1,2-Dichloroethane	ND		mg/kg	94.3	28.6	10
Cyclohexane	14600	E	mg/kg	94.3	27.2	10
2-Methylhexane	16200	E	mg/kg	94.3	22.0	10
Benzene	9120		mg/kg	94.3	20.4	10
2,3-Dimethylpentane	7000		mg/kg	94.3	23.9	10
Thiophene	ND		mg/kg	94.3	24.5	10
3-Methylhexane	15900	E	mg/kg	94.3	24.8	10
Tertiary-Amyl Methyl Ether	ND		mg/kg	94.3	25.0	10
1-Heptene/1,2-DMCP (trans)	8560		mg/kg	189	57.8	10

**Project Name:** HAWAII DOH - FINGERPRINTING**Lab Number:** L2240634**Project Number:** Not Specified**Report Date:** 09/08/22**SAMPLE RESULTS**

Lab ID: L2240634-01 D

Date Collected: 07/26/22 00:00

Client ID: GASOLINE 87

Date Received: 07/29/22

Sample Location: Not Specified

Field Prep: Not Specified

Sample Depth:

Parameter	Result	Qualifier	Units	RL	MDL	Dilution Factor
<b>PIANO Volatile Organics by GC/MS - Mansfield Lab</b>						
Isooctane	15100	E	mg/kg	94.3	22.0	10
Heptane	19000	E	mg/kg	94.3	25.9	10
Methylcyclohexane	14900	E	mg/kg	94.3	20.1	10
2,5-Dimethylhexane	3420		mg/kg	94.3	22.6	10
2,4-Dimethylhexane	3390		mg/kg	94.3	22.3	10
2,2,3-Trimethylpentane	1010		mg/kg	94.3	23.6	10
2,3,4-Trimethylpentane	7030		mg/kg	94.3	21.6	10
2,3,3-Trimethylpentane	7790		mg/kg	94.3	20.6	10
2,3-Dimethylhexane	2140		mg/kg	94.3	22.8	10
2-Methylheptane	8310		mg/kg	94.3	21.8	10
3-Methylheptane	6270		mg/kg	94.3	28.3	10
3-Ethylhexane	1610		mg/kg	94.3	24.1	10
Toluene	54500	E	mg/kg	94.3	13.6	10
2-Methylthiophene	ND		mg/kg	94.3	14.0	10
3-Methylthiophene	ND		mg/kg	94.3	14.5	10
1-Octene	ND		mg/kg	236	14.4	10
Octane	9010		mg/kg	94.3	20.0	10
1,2-Dibromoethane	ND		mg/kg	94.3	15.1	10
Ethylbenzene	12400	E	mg/kg	94.3	10.2	10
2-Ethylthiophene	ND		mg/kg	94.3	10.3	10
p/m-Xylene	47000	E	mg/kg	189	26.5	10
1-Nonene	ND		mg/kg	236	9.77	10
Nonane (C9)	3940		mg/kg	94.3	20.6	10
Styrene	16.2	J	mg/kg	94.3	13.1	10
o-Xylene	17600	E	mg/kg	94.3	14.5	10
Isopropylbenzene	1000		mg/kg	94.3	15.8	10
n-Propylbenzene	3720		mg/kg	94.3	17.8	10
1-Methyl-3-Ethylbenzene	11200	E	mg/kg	94.3	15.1	10
1-Methyl-4-Ethylbenzene	5210		mg/kg	94.3	17.2	10
1,3,5-Trimethylbenzene	5520		mg/kg	94.3	17.9	10
1-Decene	ND		mg/kg	94.3	13.1	10
1-Methyl-2-Ethylbenzene	4020		mg/kg	94.3	19.3	10
Decane (C10)	2190		mg/kg	94.3	14.4	10
1,2,4-Trimethylbenzene	17900	E	mg/kg	94.3	20.6	10
sec-Butylbenzene	338		mg/kg	94.3	19.1	10
1-Methyl-3-Isopropylbenzene	536		mg/kg	94.3	17.7	10
1-Methyl-4-Isopropylbenzene	179		mg/kg	94.3	21.6	10

**Project Name:** HAWAII DOH - FINGERPRINTING**Lab Number:** L2240634**Project Number:** Not Specified**Report Date:** 09/08/22**SAMPLE RESULTS**

Lab ID: L2240634-01 D

Date Collected: 07/26/22 00:00

Client ID: GASOLINE 87

Date Received: 07/29/22

Sample Location: Not Specified

Field Prep: Not Specified

Sample Depth:

Parameter	Result	Qualifier	Units	RL	MDL	Dilution Factor
<b>PIANO Volatile Organics by GC/MS - Mansfield Lab</b>						
1-Methyl-2-Isopropylbenzene	38.6	J	mg/kg	94.3	25.9	10
Indane	1870		mg/kg	94.3	21.8	10
1-Methyl-3-N-Propylbenzene	2200		mg/kg	94.3	20.8	10
1-Methyl-4-N-Propylbenzene	1040		mg/kg	94.3	22.1	10
n-Butylbenzene	717		mg/kg	94.3	23.6	10
1,2-Dimethyl-4-Ethylbenzene	2190		mg/kg	94.3	22.9	10
1,2-Diethylbenzene	158		mg/kg	94.3	21.8	10
1-Methyl-2-N-Propylbenzene	779		mg/kg	94.3	19.2	10
1,4-Dimethyl-2-Ethylbenzene	1550		mg/kg	94.3	21.0	10
Undecane	758		mg/kg	94.3	33.3	10
1,3-Dimethyl-4-Ethylbenzene	1300		mg/kg	94.3	20.2	10
1,3-Dimethyl-5-Ethylbenzene	2430		mg/kg	94.3	22.9	10
1,3-Dimethyl-2-Ethylbenzene	166		mg/kg	94.3	22.4	10
1,2-Dimethyl-3-Ethylbenzene	511		mg/kg	94.3	20.5	10
1,2,4,5-Tetramethylbenzene	1220		mg/kg	94.3	21.3	10
N-Pentylbenzene	91.9	J	mg/kg	94.3	18.7	10
Dodecane (C12)	341		mg/kg	236	41.4	10
Naphthalene	1850		mg/kg	94.3	39.3	10
Benzo thiophene	ND		mg/kg	94.3	49.8	10
MMT	ND		mg/kg	236	60.6	10
Tridecane	181	J	mg/kg	236	61.1	10
2-Methylnaphthalene	1040		mg/kg	236	62.3	10
1-Methylnaphthalene	488		mg/kg	236	69.2	10

Surrogate	% Recovery	Qualifier	Acceptance Criteria
Dibromofluoromethane	127		70-130
Toluene-d8	115		70-130
4-Bromofluorobenzene	92		70-130



**Project Name:** HAWAII DOH - FINGERPRINTING  
**Project Number:** Not Specified

**Lab Number:** L2240634  
**Report Date:** 09/08/22

**SAMPLE RESULTS**

Lab ID: L2240634-04 D2  
 Client ID: GASOLINE 91  
 Sample Location: Not Specified

Date Collected: 07/26/22 00:00  
 Date Received: 07/29/22  
 Field Prep: Not Specified

Sample Depth:

Matrix: Oil  
 Analytical Method: 1,8260B(M)  
 Analytical Date: 08/04/22 05:09  
 Analyst: RY  
 Percent Solids: Results reported on an 'AS RECEIVED' basis.

Parameter	Result	Qualifier	Units	RL	MDL	Dilution Factor
<b>PIANO Volatile Organics by GC/MS - Mansfield Lab</b>						
Isopentane	49400		mg/kg	1960	732.	200
Pentane	36900		mg/kg	1960	612.	200
2-Methylpentane	29300		mg/kg	1960	632.	200
3-Methylpentane	18700		mg/kg	1960	381.	200
n-Hexane	27500		mg/kg	1960	572.	200
Methylcyclopentane	19400		mg/kg	1960	597.	200
Cyclohexane	12600		mg/kg	1960	567.	200
2-Methylhexane	14200		mg/kg	1960	458.	200
3-Methylhexane	14200		mg/kg	1960	517.	200
Isooctane	14400		mg/kg	1960	459.	200
Heptane	17800		mg/kg	1960	539.	200
Methylcyclohexane	13600		mg/kg	1960	418.	200
Toluene	47600		mg/kg	1960	284.	200
Ethylbenzene	10600		mg/kg	1960	212.	200
p/m-Xylene	42100		mg/kg	3930	553.	200
o-Xylene	15000		mg/kg	1960	302.	200
1-Methyl-3-Ethylbenzene	10300		mg/kg	1960	315.	200
1,2,4-Trimethylbenzene	16700		mg/kg	1960	430.	200

Surrogate	% Recovery	Qualifier	Acceptance Criteria
Dibromofluoromethane	121		70-130
Toluene-d8	112		70-130
4-Bromofluorobenzene	96		70-130

**Project Name:** HAWAII DOH - FINGERPRINTING**Lab Number:** L2240634**Project Number:** Not Specified**Report Date:** 09/08/22**SAMPLE RESULTS**

Lab ID: L2240634-04 D

Date Collected: 07/26/22 00:00

Client ID: GASOLINE 91

Date Received: 07/29/22

Sample Location: Not Specified

Field Prep: Not Specified

Sample Depth:

Matrix: Oil

Analytical Method: 1,8260B(M)

Analytical Date: 08/04/22 00:25

Analyst: RY

Percent Solids: Results reported on an 'AS RECEIVED' basis.

Parameter	Result	Qualifier	Units	RL	MDL	Dilution Factor
<b>PIANO Volatile Organics by GC/MS - Mansfield Lab</b>						
Isopentane	56800	E	mg/kg	98.2	36.6	10
1-Pentene	2120		mg/kg	98.2	30.4	10
2-Methyl-1-Butene	5360		mg/kg	98.2	32.3	10
Pentane	40600	E	mg/kg	98.2	30.6	10
trans-2-Pentene	6050		mg/kg	98.2	34.6	10
cis-2-Pentene	3320		mg/kg	98.2	25.7	10
Tertiary Butanol	ND		mg/kg	1230	398.	10
Cyclopentane	4660		mg/kg	98.2	25.5	10
2,3-Dimethylbutane	6950		mg/kg	98.2	40.5	10
2-Methylpentane	31700	E	mg/kg	98.2	31.6	10
Methyl tert butyl ether	ND		mg/kg	98.2	30.6	10
3-Methylpentane	20300	E	mg/kg	98.2	19.0	10
1-Hexene	681		mg/kg	98.2	28.2	10
n-Hexane	29900	E	mg/kg	98.2	28.6	10
Isopropyl Ether	ND		mg/kg	98.2	27.0	10
Ethyl-Tert-Butyl-Ether	ND		mg/kg	98.2	25.6	10
2,2-Dimethylpentane	1120		mg/kg	98.2	25.4	10
Methylcyclopentane	20300	E	mg/kg	98.2	29.8	10
2,4-Dimethylpentane	4470		mg/kg	98.2	25.8	10
1,2-Dichloroethane	ND		mg/kg	98.2	29.7	10
Cyclohexane	14500	E	mg/kg	98.2	28.4	10
2-Methylhexane	16200	E	mg/kg	98.2	22.9	10
Benzene	8770		mg/kg	98.2	21.3	10
2,3-Dimethylpentane	6240		mg/kg	98.2	24.9	10
Thiophene	21.2	J	mg/kg	98.2	25.5	10
3-Methylhexane	16100	E	mg/kg	98.2	25.8	10
Tertiary-Amyl Methyl Ether	ND		mg/kg	98.2	26.0	10
1-Heptene/1,2-DMCP (trans)	7960		mg/kg	196	60.2	10

**Project Name:** HAWAII DOH - FINGERPRINTING**Lab Number:** L2240634**Project Number:** Not Specified**Report Date:** 09/08/22**SAMPLE RESULTS**

Lab ID: L2240634-04 D

Date Collected: 07/26/22 00:00

Client ID: GASOLINE 91

Date Received: 07/29/22

Sample Location: Not Specified

Field Prep: Not Specified

Sample Depth:

Parameter	Result	Qualifier	Units	RL	MDL	Dilution Factor
<b>PIANO Volatile Organics by GC/MS - Mansfield Lab</b>						
Isooctane	15800	E	mg/kg	98.2	23.0	10
Heptane	20100	E	mg/kg	98.2	27.0	10
Methylcyclohexane	16600	E	mg/kg	98.2	20.9	10
2,5-Dimethylhexane	3670		mg/kg	98.2	23.5	10
2,4-Dimethylhexane	3770		mg/kg	98.2	23.2	10
2,2,3-Trimethylpentane	1050		mg/kg	98.2	24.6	10
2,3,4-Trimethylpentane	7220		mg/kg	98.2	22.5	10
2,3,3-Trimethylpentane	8190		mg/kg	98.2	21.5	10
2,3-Dimethylhexane	2420		mg/kg	98.2	23.8	10
2-Methylheptane	8760		mg/kg	98.2	22.7	10
3-Methylheptane	6940		mg/kg	98.2	29.5	10
3-Ethylhexane	1520		mg/kg	98.2	25.1	10
Toluene	52500	E	mg/kg	98.2	14.2	10
2-Methylthiophene	ND		mg/kg	98.2	14.6	10
3-Methylthiophene	ND		mg/kg	98.2	15.1	10
1-Octene	ND		mg/kg	246	15.0	10
Octane	9750		mg/kg	98.2	20.8	10
1,2-Dibromoethane	ND		mg/kg	98.2	15.7	10
Ethylbenzene	12500	E	mg/kg	98.2	10.6	10
2-Ethylthiophene	ND		mg/kg	98.2	10.8	10
p/m-Xylene	48000	E	mg/kg	196	27.6	10
1-Nonene	ND		mg/kg	246	10.2	10
Nonane (C9)	4570		mg/kg	98.2	21.5	10
Styrene	17.1	J	mg/kg	98.2	13.6	10
o-Xylene	17600	E	mg/kg	98.2	15.1	10
Isopropylbenzene	1080		mg/kg	98.2	16.4	10
n-Propylbenzene	4100		mg/kg	98.2	18.5	10
1-Methyl-3-Ethylbenzene	12400	E	mg/kg	98.2	15.7	10
1-Methyl-4-Ethylbenzene	5750		mg/kg	98.2	17.9	10
1,3,5-Trimethylbenzene	6120		mg/kg	98.2	18.7	10
1-Decene	ND		mg/kg	98.2	13.6	10
1-Methyl-2-Ethylbenzene	4330		mg/kg	98.2	20.1	10
Decane (C10)	2540		mg/kg	98.2	15.0	10
1,2,4-Trimethylbenzene	19500	E	mg/kg	98.2	21.5	10
sec-Butylbenzene	384		mg/kg	98.2	19.9	10
1-Methyl-3-Isopropylbenzene	608		mg/kg	98.2	18.5	10
1-Methyl-4-Isopropylbenzene	206		mg/kg	98.2	22.5	10

**Project Name:** HAWAII DOH - FINGERPRINTING**Lab Number:** L2240634**Project Number:** Not Specified**Report Date:** 09/08/22**SAMPLE RESULTS**

Lab ID: L2240634-04 D

Date Collected: 07/26/22 00:00

Client ID: GASOLINE 91

Date Received: 07/29/22

Sample Location: Not Specified

Field Prep: Not Specified

Sample Depth:

Parameter	Result	Qualifier	Units	RL	MDL	Dilution Factor
<b>PIANO Volatile Organics by GC/MS - Mansfield Lab</b>						
1-Methyl-2-Isopropylbenzene	42.0	J	mg/kg	98.2	27.0	10
Indane	1950		mg/kg	98.2	22.7	10
1-Methyl-3-N-Propylbenzene	2530		mg/kg	98.2	21.7	10
1-Methyl-4-N-Propylbenzene	1200		mg/kg	98.2	23.0	10
n-Butylbenzene	840		mg/kg	98.2	24.5	10
1,2-Dimethyl-4-Ethylbenzene	2490		mg/kg	98.2	23.9	10
1,2-Diethylbenzene	180		mg/kg	98.2	22.7	10
1-Methyl-2-N-Propylbenzene	877		mg/kg	98.2	20.0	10
1,4-Dimethyl-2-Ethylbenzene	1730		mg/kg	98.2	21.9	10
Undecane	821		mg/kg	98.2	34.7	10
1,3-Dimethyl-4-Ethylbenzene	1460		mg/kg	98.2	21.0	10
1,3-Dimethyl-5-Ethylbenzene	2730		mg/kg	98.2	23.9	10
1,3-Dimethyl-2-Ethylbenzene	203		mg/kg	98.2	23.3	10
1,2-Dimethyl-3-Ethylbenzene	562		mg/kg	98.2	21.4	10
1,2,4,5-Tetramethylbenzene	1390		mg/kg	98.2	22.2	10
N-Pentylbenzene	99.9		mg/kg	98.2	19.4	10
Dodecane (C12)	354		mg/kg	246	43.1	10
Naphthalene	1790		mg/kg	98.2	41.0	10
Benzothiophene	ND		mg/kg	98.2	51.9	10
MMT	ND		mg/kg	246	63.1	10
Tridecane	220	J	mg/kg	246	63.7	10
2-Methylnaphthalene	1010		mg/kg	246	64.9	10
1-Methylnaphthalene	473		mg/kg	246	72.0	10

Surrogate	% Recovery	Qualifier	Acceptance Criteria
Dibromofluoromethane	122		70-130
Toluene-d8	113		70-130
4-Bromofluorobenzene	97		70-130

**Project Name:** HAWAII DOH - FINGERPRINTING  
**Project Number:** Not Specified

**Lab Number:** L2240634  
**Report Date:** 09/08/22

**SAMPLE RESULTS**

Lab ID: L2240634-07 D2  
 Client ID: GASOLINE 93  
 Sample Location: Not Specified

Date Collected: 07/26/22 00:00  
 Date Received: 07/29/22  
 Field Prep: Not Specified

Sample Depth:

Matrix: Oil  
 Analytical Method: 1,8260B(M)  
 Analytical Date: 08/04/22 23:43  
 Analyst: RY  
 Percent Solids: Results reported on an 'AS RECEIVED' basis.

Parameter	Result	Qualifier	Units	RL	MDL	Dilution Factor
<b>PIANO Volatile Organics by GC/MS - Mansfield Lab</b>						
Isopentane	44400		mg/kg	1760	658.	200
Pentane	32900		mg/kg	1760	550.	200
2-Methylpentane	27700		mg/kg	1760	568.	200
3-Methylpentane	17800		mg/kg	1760	342.	200
n-Hexane	26300		mg/kg	1760	514.	200
Methylcyclopentane	18600		mg/kg	1760	536.	200
Cyclohexane	12400		mg/kg	1760	509.	200
2-Methylhexane	14100		mg/kg	1760	411.	200
Benzene	8810		mg/kg	1760	382.	200
3-Methylhexane	14100		mg/kg	1760	464.	200
Isooctane	14100		mg/kg	1760	413.	200
Heptane	18100		mg/kg	1760	485.	200
Methylcyclohexane	13900		mg/kg	1760	376.	200
2-Methylheptane	8070		mg/kg	1760	409.	200
Toluene	50200		mg/kg	1760	255.	200
Octane	8740		mg/kg	1760	373.	200
Ethylbenzene	11300		mg/kg	1760	190.	200
p/m-Xylene	44200		mg/kg	3530	497.	200
o-Xylene	15900		mg/kg	1760	271.	200
1-Methyl-3-Ethylbenzene	10700		mg/kg	1760	283.	200
1,2,4-Trimethylbenzene	17300		mg/kg	1760	386.	200

Surrogate	% Recovery	Qualifier	Acceptance Criteria
Dibromofluoromethane	122		70-130
Toluene-d8	113		70-130
4-Bromofluorobenzene	95		70-130

**Project Name:** HAWAII DOH - FINGERPRINTING**Lab Number:** L2240634**Project Number:** Not Specified**Report Date:** 09/08/22**SAMPLE RESULTS**

Lab ID: L2240634-07 D

Date Collected: 07/26/22 00:00

Client ID: GASOLINE 93

Date Received: 07/29/22

Sample Location: Not Specified

Field Prep: Not Specified

Sample Depth:

Matrix: Oil

Analytical Method: 1,8260B(M)

Analytical Date: 08/04/22 16:33

Analyst: RY

Percent Solids: Results reported on an 'AS RECEIVED' basis.

Parameter	Result	Qualifier	Units	RL	MDL	Dilution Factor
<b>PIANO Volatile Organics by GC/MS - Mansfield Lab</b>						
Isopentane	72400	E	mg/kg	88.3	32.9	10
1-Pentene	2710		mg/kg	88.3	27.3	10
2-Methyl-1-Butene	6330		mg/kg	88.3	29.0	10
Pentane	50800	E	mg/kg	88.3	27.5	10
trans-2-Pentene	7230		mg/kg	88.3	31.1	10
cis-2-Pentene	4470		mg/kg	88.3	23.1	10
Tertiary Butanol	ND		mg/kg	1100	357.	10
Cyclopentane	5320		mg/kg	88.3	22.9	10
2,3-Dimethylbutane	8280		mg/kg	88.3	36.4	10
2-Methylpentane	38200	E	mg/kg	88.3	28.4	10
Methyl tert butyl ether	ND		mg/kg	88.3	27.5	10
3-Methylpentane	23900	E	mg/kg	88.3	17.1	10
1-Hexene	ND		mg/kg	88.3	25.3	10
n-Hexane	34800	E	mg/kg	88.3	25.7	10
Isopropyl Ether	ND		mg/kg	88.3	24.2	10
Ethyl-Tert-Butyl-Ether	ND		mg/kg	88.3	23.0	10
2,2-Dimethylpentane	1260		mg/kg	88.3	22.8	10
Methylcyclopentane	23000	E	mg/kg	88.3	26.8	10
2,4-Dimethylpentane	4760		mg/kg	88.3	23.2	10
1,2-Dichloroethane	ND		mg/kg	88.3	26.7	10
Cyclohexane	14400	E	mg/kg	88.3	25.5	10
2-Methylhexane	16600	E	mg/kg	88.3	20.6	10
Benzene	9320	E	mg/kg	88.3	19.1	10
2,3-Dimethylpentane	ND		mg/kg	88.3	22.3	10
Thiophene	15.5	J	mg/kg	88.3	22.9	10
3-Methylhexane	16100	E	mg/kg	88.3	23.2	10
Tertiary-Amyl Methyl Ether	ND		mg/kg	88.3	23.4	10
1-Heptene/1,2-DMCP (trans)	8870		mg/kg	176	54.1	10

**Project Name:** HAWAII DOH - FINGERPRINTING**Lab Number:** L2240634**Project Number:** Not Specified**Report Date:** 09/08/22**SAMPLE RESULTS**

Lab ID: L2240634-07 D

Date Collected: 07/26/22 00:00

Client ID: GASOLINE 93

Date Received: 07/29/22

Sample Location: Not Specified

Field Prep: Not Specified

Sample Depth:

Parameter	Result	Qualifier	Units	RL	MDL	Dilution Factor
<b>PIANO Volatile Organics by GC/MS - Mansfield Lab</b>						
Isooctane	15400	E	mg/kg	88.3	20.6	10
Heptane	20000	E	mg/kg	88.3	24.2	10
Methylcyclohexane	15200	E	mg/kg	88.3	18.8	10
2,5-Dimethylhexane	3860		mg/kg	88.3	21.1	10
2,4-Dimethylhexane	3530		mg/kg	88.3	20.8	10
2,2,3-Trimethylpentane	1060		mg/kg	88.3	22.1	10
2,3,4-Trimethylpentane	7760		mg/kg	88.3	20.2	10
2,3,3-Trimethylpentane	8560		mg/kg	88.3	19.3	10
2,3-Dimethylhexane	2150		mg/kg	88.3	21.4	10
2-Methylheptane	9960	E	mg/kg	88.3	20.4	10
3-Methylheptane	6700		mg/kg	88.3	26.5	10
3-Ethylhexane	1860		mg/kg	88.3	22.5	10
Toluene	53900	E	mg/kg	88.3	12.8	10
2-Methylthiophene	ND		mg/kg	88.3	13.1	10
3-Methylthiophene	ND		mg/kg	88.3	13.6	10
1-Octene	ND		mg/kg	221	13.5	10
Octane	9940	E	mg/kg	88.3	18.7	10
1,2-Dibromoethane	ND		mg/kg	88.3	14.1	10
Ethylbenzene	12200	E	mg/kg	88.3	9.53	10
2-Ethylthiophene	ND		mg/kg	88.3	9.66	10
p/m-Xylene	44900	E	mg/kg	176	24.8	10
1-Nonene	ND		mg/kg	221	9.14	10
Nonane (C9)	4510		mg/kg	88.3	19.3	10
Styrene	17.3	J	mg/kg	88.3	12.2	10
o-Xylene	16500	E	mg/kg	88.3	13.6	10
Isopropylbenzene	1000		mg/kg	88.3	14.7	10
n-Propylbenzene	3760		mg/kg	88.3	16.6	10
1-Methyl-3-Ethylbenzene	11200	E	mg/kg	88.3	14.1	10
1-Methyl-4-Ethylbenzene	5200		mg/kg	88.3	16.1	10
1,3,5-Trimethylbenzene	5500		mg/kg	88.3	16.8	10
1-Decene	ND		mg/kg	88.3	12.2	10
1-Methyl-2-Ethylbenzene	3890		mg/kg	88.3	18.0	10
Decane (C10)	2420		mg/kg	88.3	13.5	10
1,2,4-Trimethylbenzene	17500	E	mg/kg	88.3	19.3	10
sec-Butylbenzene	345		mg/kg	88.3	17.8	10
1-Methyl-3-Isopropylbenzene	543		mg/kg	88.3	16.6	10
1-Methyl-4-Isopropylbenzene	186		mg/kg	88.3	20.2	10

**Project Name:** HAWAII DOH - FINGERPRINTING**Lab Number:** L2240634**Project Number:** Not Specified**Report Date:** 09/08/22**SAMPLE RESULTS**

Lab ID: L2240634-07 D

Date Collected: 07/26/22 00:00

Client ID: GASOLINE 93

Date Received: 07/29/22

Sample Location: Not Specified

Field Prep: Not Specified

Sample Depth:

Parameter	Result	Qualifier	Units	RL	MDL	Dilution Factor
<b>PIANO Volatile Organics by GC/MS - Mansfield Lab</b>						
1-Methyl-2-Isopropylbenzene	39.3	J	mg/kg	88.3	24.2	10
Indane	1730		mg/kg	88.3	20.4	10
1-Methyl-3-N-Propylbenzene	2260		mg/kg	88.3	19.5	10
1-Methyl-4-N-Propylbenzene	1080		mg/kg	88.3	20.7	10
n-Butylbenzene	752		mg/kg	88.3	22.0	10
1,2-Dimethyl-4-Ethylbenzene	2220		mg/kg	88.3	21.5	10
1,2-Diethylbenzene	164		mg/kg	88.3	20.4	10
1-Methyl-2-N-Propylbenzene	792		mg/kg	88.3	18.0	10
1,4-Dimethyl-2-Ethylbenzene	1540		mg/kg	88.3	19.7	10
Undecane	752		mg/kg	88.3	31.2	10
1,3-Dimethyl-4-Ethylbenzene	1290		mg/kg	88.3	18.9	10
1,3-Dimethyl-5-Ethylbenzene	2410		mg/kg	88.3	21.5	10
1,3-Dimethyl-2-Ethylbenzene	173		mg/kg	88.3	20.9	10
1,2-Dimethyl-3-Ethylbenzene	496		mg/kg	88.3	19.2	10
1,2,4,5-Tetramethylbenzene	1200		mg/kg	88.3	19.9	10
N-Pentylbenzene	89.4		mg/kg	88.3	17.4	10
Dodecane (C12)	318		mg/kg	221	38.7	10
Naphthalene	1540		mg/kg	88.3	36.8	10
Benzo thiophene	ND		mg/kg	88.3	46.6	10
MMT	ND		mg/kg	221	56.7	10
Tridecane	190	J	mg/kg	221	57.2	10
2-Methylnaphthalene	882		mg/kg	221	58.3	10
1-Methylnaphthalene	407		mg/kg	221	64.7	10

Surrogate	% Recovery	Qualifier	Acceptance Criteria
Dibromofluoromethane	119		70-130
Toluene-d8	114		70-130
4-Bromofluorobenzene	90		70-130



**Project Name:** HAWAII DOH - FINGERPRINTING**Lab Number:** L2240634**Project Number:** Not Specified**Report Date:** 09/08/22**SAMPLE RESULTS**

Lab ID: L2240634-10 D

Date Collected: 07/26/22 00:00

Client ID: HEATING FUEL

Date Received: 07/29/22

Sample Location: Not Specified

Field Prep: Not Specified

Sample Depth:

Matrix: Oil

Analytical Method: 1,8260B(M)

Analytical Date: 08/04/22 17:44

Analyst: RY

Percent Solids: Results reported on an 'AS RECEIVED' basis.

Parameter	Result	Qualifier	Units	RL	MDL	Dilution Factor
<b>PIANO Volatile Organics by GC/MS - Mansfield Lab</b>						
Isopentane	18.3	J	mg/kg	97.8	36.5	10
1-Pentene	ND		mg/kg	97.8	30.3	10
2-Methyl-1-Butene	ND		mg/kg	97.8	32.1	10
Pentane	ND		mg/kg	97.8	30.5	10
trans-2-Pentene	ND		mg/kg	97.8	34.5	10
cis-2-Pentene	ND		mg/kg	97.8	25.6	10
Tertiary Butanol	ND		mg/kg	1220	396.	10
Cyclopentane	ND		mg/kg	97.8	25.4	10
2,3-Dimethylbutane	ND		mg/kg	97.8	40.4	10
2-Methylpentane	16.2	J	mg/kg	97.8	31.5	10
Methyl tert butyl ether	ND		mg/kg	97.8	30.5	10
3-Methylpentane	7.58	J	mg/kg	97.8	19.0	10
1-Hexene	ND		mg/kg	97.8	28.1	10
n-Hexane	21.7	JB	mg/kg	97.8	28.5	10
Isopropyl Ether	ND		mg/kg	97.8	26.9	10
Ethyl-Tert-Butyl-Ether	ND		mg/kg	97.8	25.5	10
2,2-Dimethylpentane	ND		mg/kg	97.8	25.3	10
Methylcyclopentane	8.56	J	mg/kg	97.8	29.7	10
2,4-Dimethylpentane	ND		mg/kg	97.8	25.7	10
1,2-Dichloroethane	ND		mg/kg	97.8	29.6	10
Cyclohexane	ND		mg/kg	97.8	28.2	10
2-Methylhexane	ND		mg/kg	97.8	22.8	10
Benzene	31.4	J	mg/kg	97.8	21.2	10
2,3-Dimethylpentane	ND		mg/kg	97.8	24.8	10
Thiophene	ND		mg/kg	97.8	25.4	10
3-Methylhexane	ND		mg/kg	97.8	25.8	10
Tertiary-Amyl Methyl Ether	ND		mg/kg	97.8	25.9	10
1-Heptene/1,2-DMCP (trans)	ND		mg/kg	196	60.0	10

**Project Name:** HAWAII DOH - FINGERPRINTING**Lab Number:** L2240634**Project Number:** Not Specified**Report Date:** 09/08/22**SAMPLE RESULTS**

Lab ID: L2240634-10 D

Date Collected: 07/26/22 00:00

Client ID: HEATING FUEL

Date Received: 07/29/22

Sample Location: Not Specified

Field Prep: Not Specified

Sample Depth:

Parameter	Result	Qualifier	Units	RL	MDL	Dilution Factor
<b>PIANO Volatile Organics by GC/MS - Mansfield Lab</b>						
Isooctane	4.55	J	mg/kg	97.8	22.9	10
Heptane	26.8	J	mg/kg	97.8	26.9	10
Methylcyclohexane	50.3	J	mg/kg	97.8	20.8	10
2,5-Dimethylhexane	ND		mg/kg	97.8	23.4	10
2,4-Dimethylhexane	ND		mg/kg	97.8	23.1	10
2,2,3-Trimethylpentane	ND		mg/kg	97.8	24.5	10
2,3,4-Trimethylpentane	ND		mg/kg	97.8	22.4	10
2,3,3-Trimethylpentane	ND		mg/kg	97.8	21.4	10
2,3-Dimethylhexane	18.4	J	mg/kg	97.8	23.7	10
2-Methylheptane	139		mg/kg	97.8	22.6	10
3-Methylheptane	154		mg/kg	97.8	29.4	10
3-Ethylhexane	ND		mg/kg	97.8	25.0	10
Toluene	110		mg/kg	97.8	14.2	10
2-Methylthiophene	ND		mg/kg	97.8	14.6	10
3-Methylthiophene	ND		mg/kg	97.8	15.1	10
1-Octene	ND		mg/kg	245	14.9	10
Octane	657		mg/kg	97.8	20.7	10
1,2-Dibromoethane	ND		mg/kg	97.8	15.6	10
Ethylbenzene	344		mg/kg	97.8	10.6	10
2-Ethylthiophene	ND		mg/kg	97.8	10.7	10
p/m-Xylene	1540		mg/kg	196	27.5	10
1-Nonene	ND		mg/kg	245	10.1	10
Nonane (C9)	3840		mg/kg	97.8	21.4	10
Styrene	ND		mg/kg	97.8	13.6	10
o-Xylene	807		mg/kg	97.8	15.0	10
Isopropylbenzene	220		mg/kg	97.8	16.3	10
n-Propylbenzene	630		mg/kg	97.8	18.4	10
1-Methyl-3-Ethylbenzene	2000		mg/kg	97.8	15.7	10
1-Methyl-4-Ethylbenzene	916		mg/kg	97.8	17.8	10
1,3,5-Trimethylbenzene	1230		mg/kg	97.8	18.6	10
1-Decene	ND		mg/kg	97.8	13.6	10
1-Methyl-2-Ethylbenzene	1020		mg/kg	97.8	20.0	10
Decane (C10)	8030		mg/kg	97.8	14.9	10
1,2,4-Trimethylbenzene	4110		mg/kg	97.8	21.4	10
sec-Butylbenzene	415		mg/kg	97.8	19.8	10
1-Methyl-3-Isopropylbenzene	568		mg/kg	97.8	18.4	10
1-Methyl-4-Isopropylbenzene	324		mg/kg	97.8	22.4	10

**Project Name:** HAWAII DOH - FINGERPRINTING  
**Project Number:** Not Specified

**Lab Number:** L2240634  
**Report Date:** 09/08/22

**SAMPLE RESULTS**

Lab ID: L2240634-10 D  
 Client ID: HEATING FUEL  
 Sample Location: Not Specified

Date Collected: 07/26/22 00:00  
 Date Received: 07/29/22  
 Field Prep: Not Specified

Sample Depth:

Parameter	Result	Qualifier	Units	RL	MDL	Dilution Factor
<b>PIANO Volatile Organics by GC/MS - Mansfield Lab</b>						
1-Methyl-2-Isopropylbenzene	71.3	J	mg/kg	97.8	26.8	10
Indane	671		mg/kg	97.8	22.6	10
1-Methyl-3-N-Propylbenzene	1440		mg/kg	97.8	21.6	10
1-Methyl-4-N-Propylbenzene	687		mg/kg	97.8	23.0	10
n-Butylbenzene	632		mg/kg	97.8	24.4	10
1,2-Dimethyl-4-Ethylbenzene	1210		mg/kg	97.8	23.8	10
1,2-Diethylbenzene	223		mg/kg	97.8	22.6	10
1-Methyl-2-N-Propylbenzene	898		mg/kg	97.8	19.9	10
1,4-Dimethyl-2-Ethylbenzene	1040		mg/kg	97.8	21.8	10
Undecane	7310		mg/kg	97.8	34.5	10
1,3-Dimethyl-4-Ethylbenzene	1060		mg/kg	97.8	20.9	10
1,3-Dimethyl-5-Ethylbenzene	1430		mg/kg	97.8	23.8	10
1,3-Dimethyl-2-Ethylbenzene	217		mg/kg	97.8	23.2	10
1,2-Dimethyl-3-Ethylbenzene	514		mg/kg	97.8	21.3	10
1,2,4,5-Tetramethylbenzene	774		mg/kg	97.8	22.1	10
N-Pentylbenzene	882		mg/kg	97.8	19.4	10
Dodecane (C12)	6580		mg/kg	245	42.9	10
Naphthalene	790		mg/kg	97.8	40.8	10
Benzothiophene	ND		mg/kg	97.8	51.7	10
MMT	ND		mg/kg	245	62.8	10
Tridecane	6630		mg/kg	245	63.4	10
2-Methylnaphthalene	2180		mg/kg	245	64.6	10
1-Methylnaphthalene	1280		mg/kg	245	71.8	10

Surrogate	% Recovery	Qualifier	Acceptance Criteria
Dibromofluoromethane	118		70-130
Toluene-d8	109		70-130
4-Bromofluorobenzene	100		70-130

**Project Name:** HAWAII DOH - FINGERPRINTING**Lab Number:** L2240634**Project Number:** Not Specified**Report Date:** 09/08/22**SAMPLE RESULTS**

Lab ID: L2240634-13 D2

Date Collected: 07/26/22 00:00

Client ID: ROAD DIESEL

Date Received: 07/29/22

Sample Location: Not Specified

Field Prep: Not Specified

Sample Depth:

Matrix: Oil

Analytical Method: 1,8260B(M)

Analytical Date: 08/05/22 02:06

Analyst: RY

Percent Solids: Results reported on an 'AS RECEIVED' basis.

Parameter	Result	Qualifier	Units	RL	MDL	Dilution Factor
-----------	--------	-----------	-------	----	-----	-----------------

## PIANO Volatile Organics by GC/MS - Mansfield Lab

1,2,4-Trimethylbenzene	9340		mg/kg	1820	399.	200
------------------------	------	--	-------	------	------	-----

Surrogate	% Recovery	Qualifier	Acceptance Criteria
Dibromofluoromethane	100		70-130
Toluene-d8	112		70-130
4-Bromofluorobenzene	94		70-130

**Project Name:** HAWAII DOH - FINGERPRINTING**Lab Number:** L2240634**Project Number:** Not Specified**Report Date:** 09/08/22**SAMPLE RESULTS**

Lab ID: L2240634-13 D

Date Collected: 07/26/22 00:00

Client ID: ROAD DIESEL

Date Received: 07/29/22

Sample Location: Not Specified

Field Prep: Not Specified

Sample Depth:

Matrix: Oil

Analytical Method: 1,8260B(M)

Analytical Date: 08/04/22 18:56

Analyst: RY

Percent Solids: Results reported on an 'AS RECEIVED' basis.

Parameter	Result	Qualifier	Units	RL	MDL	Dilution Factor
<b>PIANO Volatile Organics by GC/MS - Mansfield Lab</b>						
Isopentane	121		mg/kg	91.2	34.0	10
1-Pentene	ND		mg/kg	91.2	28.2	10
2-Methyl-1-Butene	ND		mg/kg	91.2	29.9	10
Pentane	90.3	J	mg/kg	91.2	28.4	10
trans-2-Pentene	ND		mg/kg	91.2	32.1	10
cis-2-Pentene	ND		mg/kg	91.2	23.9	10
Tertiary Butanol	ND		mg/kg	1140	369.	10
Cyclopentane	23.2	J	mg/kg	91.2	23.6	10
2,3-Dimethylbutane	22.4	J	mg/kg	91.2	37.6	10
2-Methylpentane	92.6		mg/kg	91.2	29.3	10
Methyl tert butyl ether	ND		mg/kg	91.2	28.4	10
3-Methylpentane	73.7	J	mg/kg	91.2	17.7	10
1-Hexene	ND		mg/kg	91.2	26.2	10
n-Hexane	130		mg/kg	91.2	26.6	10
Isopropyl Ether	ND		mg/kg	91.2	25.0	10
Ethyl-Tert-Butyl-Ether	ND		mg/kg	91.2	23.8	10
2,2-Dimethylpentane	ND		mg/kg	91.2	23.6	10
Methylcyclopentane	157		mg/kg	91.2	27.7	10
2,4-Dimethylpentane	ND		mg/kg	91.2	23.9	10
1,2-Dichloroethane	ND		mg/kg	91.2	27.6	10
Cyclohexane	296		mg/kg	91.2	26.3	10
2-Methylhexane	124		mg/kg	91.2	21.2	10
Benzene	90.0	J	mg/kg	91.2	19.7	10
2,3-Dimethylpentane	58.7	J	mg/kg	91.2	23.1	10
Thiophene	ND		mg/kg	91.2	23.7	10
3-Methylhexane	163		mg/kg	91.2	24.0	10
Tertiary-Amyl Methyl Ether	ND		mg/kg	91.2	24.1	10
1-Heptene/1,2-DMCP (trans)	163	J	mg/kg	182	55.9	10

**Project Name:** HAWAII DOH - FINGERPRINTING**Lab Number:** L2240634**Project Number:** Not Specified**Report Date:** 09/08/22**SAMPLE RESULTS**

Lab ID: L2240634-13 D

Date Collected: 07/26/22 00:00

Client ID: ROAD DIESEL

Date Received: 07/29/22

Sample Location: Not Specified

Field Prep: Not Specified

Sample Depth:

Parameter	Result	Qualifier	Units	RL	MDL	Dilution Factor
<b>PIANO Volatile Organics by GC/MS - Mansfield Lab</b>						
Isooctane	23.8	J	mg/kg	91.2	21.3	10
Heptane	330		mg/kg	91.2	25.0	10
Methylcyclohexane	1050		mg/kg	91.2	19.4	10
2,5-Dimethylhexane	43.0	J	mg/kg	91.2	21.8	10
2,4-Dimethylhexane	57.6	J	mg/kg	91.2	21.5	10
2,2,3-Trimethylpentane	ND		mg/kg	91.2	22.8	10
2,3,4-Trimethylpentane	21.6	J	mg/kg	91.2	20.9	10
2,3,3-Trimethylpentane	18.7	J	mg/kg	91.2	20.0	10
2,3-Dimethylhexane	57.4	J	mg/kg	91.2	22.1	10
2-Methylheptane	420		mg/kg	91.2	21.1	10
3-Methylheptane	340		mg/kg	91.2	27.4	10
3-Ethylhexane	76.3	J	mg/kg	91.2	23.3	10
Toluene	674		mg/kg	91.2	13.2	10
2-Methylthiophene	ND		mg/kg	91.2	13.6	10
3-Methylthiophene	ND		mg/kg	91.2	14.0	10
1-Octene	ND		mg/kg	228	13.9	10
Octane	1010		mg/kg	91.2	19.3	10
1,2-Dibromoethane	ND		mg/kg	91.2	14.6	10
Ethylbenzene	1600		mg/kg	91.2	9.84	10
2-Ethylthiophene	ND		mg/kg	91.2	9.98	10
p/m-Xylene	7880		mg/kg	182	25.6	10
1-Nonene	ND		mg/kg	228	9.44	10
Nonane (C9)	3770		mg/kg	91.2	19.9	10
Styrene	ND		mg/kg	91.2	12.6	10
o-Xylene	3750		mg/kg	91.2	14.0	10
Isopropylbenzene	364		mg/kg	91.2	15.2	10
n-Propylbenzene	1510		mg/kg	91.2	17.2	10
1-Methyl-3-Ethylbenzene	6570		mg/kg	91.2	14.6	10
1-Methyl-4-Ethylbenzene	2640		mg/kg	91.2	16.6	10
1,3,5-Trimethylbenzene	3260		mg/kg	91.2	17.3	10
1-Decene	ND		mg/kg	91.2	12.7	10
1-Methyl-2-Ethylbenzene	2150		mg/kg	91.2	18.6	10
Decane (C10)	5360		mg/kg	91.2	13.9	10
1,2,4-Trimethylbenzene	11100	E	mg/kg	91.2	19.9	10
sec-Butylbenzene	382		mg/kg	91.2	18.4	10
1-Methyl-3-Isopropylbenzene	650		mg/kg	91.2	17.1	10
1-Methyl-4-Isopropylbenzene	281		mg/kg	91.2	20.9	10

**Project Name:** HAWAII DOH - FINGERPRINTING**Lab Number:** L2240634**Project Number:** Not Specified**Report Date:** 09/08/22**SAMPLE RESULTS**

Lab ID: L2240634-13 D

Date Collected: 07/26/22 00:00

Client ID: ROAD DIESEL

Date Received: 07/29/22

Sample Location: Not Specified

Field Prep: Not Specified

Sample Depth:

Parameter	Result	Qualifier	Units	RL	MDL	Dilution Factor
<b>PIANO Volatile Organics by GC/MS - Mansfield Lab</b>						
1-Methyl-2-Isopropylbenzene	60.7	J	mg/kg	91.2	25.0	10
Indane	2010		mg/kg	91.2	21.1	10
1-Methyl-3-N-Propylbenzene	2450		mg/kg	91.2	20.1	10
1-Methyl-4-N-Propylbenzene	1060		mg/kg	91.2	21.4	10
n-Butylbenzene	812		mg/kg	91.2	22.8	10
1,2-Dimethyl-4-Ethylbenzene	2500		mg/kg	91.2	22.2	10
1,2-Diethylbenzene	216		mg/kg	91.2	21.1	10
1-Methyl-2-N-Propylbenzene	884		mg/kg	91.2	18.6	10
1,4-Dimethyl-2-Ethylbenzene	1920		mg/kg	91.2	20.3	10
Undecane	5260		mg/kg	91.2	32.2	10
1,3-Dimethyl-4-Ethylbenzene	1610		mg/kg	91.2	19.5	10
1,3-Dimethyl-5-Ethylbenzene	2820		mg/kg	91.2	22.2	10
1,3-Dimethyl-2-Ethylbenzene	221		mg/kg	91.2	21.6	10
1,2-Dimethyl-3-Ethylbenzene	696		mg/kg	91.2	19.8	10
1,2,4,5-Tetramethylbenzene	1580		mg/kg	91.2	20.6	10
N-Pentylbenzene	476		mg/kg	91.2	18.0	10
Dodecane (C12)	5520		mg/kg	228	40.0	10
Naphthalene	560		mg/kg	91.2	38.0	10
Benzo thiophene	ND		mg/kg	91.2	48.1	10
MMT	ND		mg/kg	228	58.6	10
Tridecane	6510		mg/kg	228	59.1	10
2-Methylnaphthalene	1650		mg/kg	228	60.2	10
1-Methylnaphthalene	896		mg/kg	228	66.9	10

Surrogate	% Recovery	Qualifier	Acceptance Criteria
Dibromofluoromethane	121		70-130
Toluene-d8	112		70-130
4-Bromofluorobenzene	96		70-130

**Project Name:** HAWAII DOH - FINGERPRINTING**Lab Number:** L2240634**Project Number:** Not Specified**Report Date:** 09/08/22**SAMPLE RESULTS**

Lab ID: L2240634-25 D

Date Collected: 07/26/22 00:00

Client ID: BUNKER C

Date Received: 07/29/22

Sample Location: Not Specified

Field Prep: Not Specified

Sample Depth:

Matrix: Oil

Analytical Method: 1,8260B(M)

Analytical Date: 08/05/22 14:03

Analyst: RY

Percent Solids: Results reported on an 'AS RECEIVED' basis.

Parameter	Result	Qualifier	Units	RL	MDL	Dilution Factor
<b>PIANO Volatile Organics by GC/MS - Mansfield Lab</b>						
Isopentane	ND		mg/kg	36.7	13.7	4
1-Pentene	ND		mg/kg	36.7	11.3	4
2-Methyl-1-Butene	ND		mg/kg	36.7	12.0	4
Pentane	ND		mg/kg	36.7	11.4	4
trans-2-Pentene	ND		mg/kg	36.7	12.9	4
cis-2-Pentene	ND		mg/kg	36.7	9.60	4
Tertiary Butanol	ND		mg/kg	458	148.	4
Cyclopentane	ND		mg/kg	36.7	9.51	4
2,3-Dimethylbutane	ND		mg/kg	36.7	15.1	4
2-Methylpentane	ND		mg/kg	36.7	11.8	4
Methyl tert butyl ether	ND		mg/kg	36.7	11.4	4
3-Methylpentane	ND		mg/kg	36.7	7.11	4
1-Hexene	ND		mg/kg	36.7	10.5	4
n-Hexane	6.82	JB	mg/kg	36.7	10.7	4
Isopropyl Ether	ND		mg/kg	36.7	10.1	4
Ethyl-Tert-Butyl-Ether	ND		mg/kg	36.7	9.56	4
2,2-Dimethylpentane	ND		mg/kg	36.7	9.49	4
Methylcyclopentane	ND		mg/kg	36.7	11.1	4
2,4-Dimethylpentane	ND		mg/kg	36.7	9.63	4
1,2-Dichloroethane	ND		mg/kg	36.7	11.1	4
Cyclohexane	ND		mg/kg	36.7	10.6	4
2-Methylhexane	ND		mg/kg	36.7	8.54	4
Benzene	11.3	JB	mg/kg	36.7	7.94	4
2,3-Dimethylpentane	ND		mg/kg	36.7	9.28	4
Thiophene	ND		mg/kg	36.7	9.52	4
3-Methylhexane	ND		mg/kg	36.7	9.65	4
Tertiary-Amyl Methyl Ether	ND		mg/kg	36.7	9.70	4
1-Heptene/1,2-DMCP (trans)	ND		mg/kg	73.3	22.5	4



**Project Name:** HAWAII DOH - FINGERPRINTING**Lab Number:** L2240634**Project Number:** Not Specified**Report Date:** 09/08/22**SAMPLE RESULTS**

Lab ID: L2240634-25 D

Date Collected: 07/26/22 00:00

Client ID: BUNKER C

Date Received: 07/29/22

Sample Location: Not Specified

Field Prep: Not Specified

Sample Depth:

Parameter	Result	Qualifier	Units	RL	MDL	Dilution Factor
<b>PIANO Volatile Organics by GC/MS - Mansfield Lab</b>						
Isooctane	ND		mg/kg	36.7	8.57	4
Heptane	ND		mg/kg	36.7	10.1	4
Methylcyclohexane	ND		mg/kg	36.7	7.80	4
2,5-Dimethylhexane	ND		mg/kg	36.7	8.77	4
2,4-Dimethylhexane	ND		mg/kg	36.7	8.65	4
2,2,3-Trimethylpentane	ND		mg/kg	36.7	9.18	4
2,3,4-Trimethylpentane	ND		mg/kg	36.7	8.41	4
2,3,3-Trimethylpentane	ND		mg/kg	36.7	8.03	4
2,3-Dimethylhexane	ND		mg/kg	36.7	8.88	4
2-Methylheptane	ND		mg/kg	36.7	8.49	4
3-Methylheptane	ND		mg/kg	36.7	11.0	4
3-Ethylhexane	ND		mg/kg	36.7	9.36	4
Toluene	8.27	J	mg/kg	36.7	5.30	4
2-Methylthiophene	ND		mg/kg	36.7	5.46	4
3-Methylthiophene	ND		mg/kg	36.7	5.65	4
1-Octene	ND		mg/kg	91.6	5.60	4
Octane	6.16	J	mg/kg	36.7	7.76	4
1,2-Dibromoethane	ND		mg/kg	36.7	5.86	4
Ethylbenzene	5.52	J	mg/kg	36.7	3.96	4
2-Ethylthiophene	ND		mg/kg	36.7	4.01	4
p/m-Xylene	23.0	J	mg/kg	73.3	10.3	4
1-Nonene	ND		mg/kg	91.6	3.80	4
Nonane (C9)	25.2	J	mg/kg	36.7	8.02	4
Styrene	ND		mg/kg	36.7	5.09	4
o-Xylene	12.2	J	mg/kg	36.7	5.63	4
Isopropylbenzene	3.41	J	mg/kg	36.7	6.12	4
n-Propylbenzene	12.0	J	mg/kg	36.7	6.92	4
1-Methyl-3-Ethylbenzene	45.9		mg/kg	36.7	5.88	4
1-Methyl-4-Ethylbenzene	22.1	J	mg/kg	36.7	6.67	4
1,3,5-Trimethylbenzene	39.7		mg/kg	36.7	6.97	4
1-Decene	ND		mg/kg	36.7	5.09	4
1-Methyl-2-Ethylbenzene	31.4	J	mg/kg	36.7	7.50	4
Decane (C10)	246		mg/kg	36.7	5.60	4
1,2,4-Trimethylbenzene	206		mg/kg	36.7	8.02	4
sec-Butylbenzene	14.4	J	mg/kg	36.7	7.42	4
1-Methyl-3-Isopropylbenzene	24.7	J	mg/kg	36.7	6.89	4
1-Methyl-4-Isopropylbenzene	14.0	J	mg/kg	36.7	8.40	4

**Project Name:** HAWAII DOH - FINGERPRINTING**Lab Number:** L2240634**Project Number:** Not Specified**Report Date:** 09/08/22**SAMPLE RESULTS**

Lab ID: L2240634-25 D

Date Collected: 07/26/22 00:00

Client ID: BUNKER C

Date Received: 07/29/22

Sample Location: Not Specified

Field Prep: Not Specified

Sample Depth:

Parameter	Result	Qualifier	Units	RL	MDL	Dilution Factor
<b>PIANO Volatile Organics by GC/MS - Mansfield Lab</b>						
1-Methyl-2-Isopropylbenzene	3.68	J	mg/kg	36.7	10.0	4
Indane	66.3		mg/kg	36.7	8.48	4
1-Methyl-3-N-Propylbenzene	141		mg/kg	36.7	8.09	4
1-Methyl-4-N-Propylbenzene	70.2		mg/kg	36.7	8.60	4
n-Butylbenzene	58.3		mg/kg	36.7	9.15	4
1,2-Dimethyl-4-Ethylbenzene	170		mg/kg	36.7	8.92	4
1,2-Diethylbenzene	19.6	J	mg/kg	36.7	8.47	4
1-Methyl-2-N-Propylbenzene	82.2		mg/kg	36.7	7.46	4
1,4-Dimethyl-2-Ethylbenzene	174		mg/kg	36.7	8.18	4
Undecane	833		mg/kg	36.7	12.9	4
1,3-Dimethyl-4-Ethylbenzene	176		mg/kg	36.7	7.85	4
1,3-Dimethyl-5-Ethylbenzene	297		mg/kg	36.7	8.91	4
1,3-Dimethyl-2-Ethylbenzene	44.6		mg/kg	36.7	8.69	4
1,2-Dimethyl-3-Ethylbenzene	102		mg/kg	36.7	7.98	4
1,2,4,5-Tetramethylbenzene	204		mg/kg	36.7	8.28	4
N-Pentylbenzene	115		mg/kg	36.7	7.25	4
Dodecane (C12)	765		mg/kg	91.6	16.1	4
Naphthalene	1120		mg/kg	36.7	15.3	4
Benzothiophene	ND		mg/kg	36.7	19.4	4
MMT	ND		mg/kg	91.6	23.6	4
Tridecane	736		mg/kg	91.6	23.8	4
2-Methylnaphthalene	1620		mg/kg	91.6	24.2	4
1-Methylnaphthalene	913		mg/kg	91.6	26.9	4

Surrogate	% Recovery	Qualifier	Acceptance Criteria
Dibromofluoromethane	121		70-130
Toluene-d8	111		70-130
4-Bromofluorobenzene	94		70-130

**Project Name:** HAWAII DOH - FINGERPRINTING**Lab Number:** L2240634**Project Number:** Not Specified**Report Date:** 09/08/22**SAMPLE RESULTS**

Lab ID: L2240634-30 D2

Date Collected: 08/17/22 12:15

Client ID: JP-5 MEOH (20 MG/ML)

Date Received: 08/17/22

Sample Location: Not Specified

Field Prep: Not Specified

Sample Depth:

Matrix: Oil

Analytical Method: 1,8260B(M)

Analytical Date: 08/20/22 12:00

Analyst: RY

Percent Solids: Results reported on an 'AS RECEIVED' basis.

Parameter	Result	Qualifier	Units	RL	MDL	Dilution Factor
<b>PIANO Volatile Organics by GC/MS - Mansfield Lab</b>						
Decane (C10)	2480000		mg/kg	33300	5090	80
Undecane	3040000		mg/kg	33300	11800	80
Dodecane (C12)	2140000		mg/kg	83300	14600	80
Tridecane	1850000		mg/kg	83300	21600	80

Surrogate	% Recovery	Qualifier	Acceptance Criteria
Dibromofluoromethane	114		70-130
Toluene-d8	109		70-130
4-Bromofluorobenzene	97		70-130

**Project Name:** HAWAII DOH - FINGERPRINTING**Lab Number:** L2240634**Project Number:** Not Specified**Report Date:** 09/08/22**SAMPLE RESULTS**

Lab ID: L2240634-30 D  
 Client ID: JP-5 MEOH (20 MG/ML)  
 Sample Location: Not Specified

Date Collected: 08/17/22 12:15  
 Date Received: 08/17/22  
 Field Prep: Not Specified

Sample Depth:

Matrix: Oil  
 Analytical Method: 1,8260B(M)  
 Analytical Date: 08/19/22 17:04  
 Analyst: RY  
 Percent Solids: Results reported on an 'AS RECEIVED' basis.

Parameter	Result	Qualifier	Units	RL	MDL	Dilution Factor
<b>PIANO Volatile Organics by GC/MS - Mansfield Lab</b>						
Isopentane	ND		mg/kg	8330	3100	20
1-Pentene	ND		mg/kg	8330	2580	20
2-Methyl-1-Butene	ND		mg/kg	8330	2740	20
Pentane	ND		mg/kg	8330	2600	20
trans-2-Pentene	ND		mg/kg	8330	2940	20
cis-2-Pentene	ND		mg/kg	8330	2180	20
Tertiary Butanol	ND		mg/kg	104000	33800	20
Cyclopentane	ND		mg/kg	8330	2160	20
2,3-Dimethylbutane	ND		mg/kg	8330	3440	20
2-Methylpentane	ND		mg/kg	8330	2680	20
Methyl tert butyl ether	ND		mg/kg	8330	2590	20
3-Methylpentane	ND		mg/kg	8330	1620	20
1-Hexene	ND		mg/kg	8330	2390	20
n-Hexane	1390	J	mg/kg	8330	2430	20
Isopropyl Ether	ND		mg/kg	8330	2290	20
Ethyl-Tert-Butyl-Ether	ND		mg/kg	8330	2170	20
2,2-Dimethylpentane	ND		mg/kg	8330	2160	20
Methylcyclopentane	ND		mg/kg	8330	2530	20
2,4-Dimethylpentane	ND		mg/kg	8330	2190	20
1,2-Dichloroethane	ND		mg/kg	8330	2520	20
Cyclohexane	996	J	mg/kg	8330	2400	20
2-Methylhexane	ND		mg/kg	8330	1940	20
Benzene	1640	J	mg/kg	8330	1800	20
2,3-Dimethylpentane	ND		mg/kg	8330	2110	20
Thiophene	ND		mg/kg	8330	2160	20
3-Methylhexane	1900	J	mg/kg	8330	2190	20
Tertiary-Amyl Methyl Ether	ND		mg/kg	8330	2200	20
1-Heptene/1,2-DMCP (trans)	3680	J	mg/kg	16700	5110	20

**Project Name:** HAWAII DOH - FINGERPRINTING**Lab Number:** L2240634**Project Number:** Not Specified**Report Date:** 09/08/22**SAMPLE RESULTS**

Lab ID: L2240634-30 D  
 Client ID: JP-5 MEOH (20 MG/ML)  
 Sample Location: Not Specified

Date Collected: 08/17/22 12:15  
 Date Received: 08/17/22  
 Field Prep: Not Specified

Sample Depth:

Parameter	Result	Qualifier	Units	RL	MDL	Dilution Factor
<b>PIANO Volatile Organics by GC/MS - Mansfield Lab</b>						
Isooctane	ND		mg/kg	8330	1950	20
Heptane	8810		mg/kg	8330	2290	20
Methylcyclohexane	19100		mg/kg	8330	1770	20
2,5-Dimethylhexane	892	J	mg/kg	8330	1990	20
2,4-Dimethylhexane	1140	J	mg/kg	8330	1970	20
2,2,3-Trimethylpentane	ND		mg/kg	8330	2080	20
2,3,4-Trimethylpentane	ND		mg/kg	8330	1910	20
2,3,3-Trimethylpentane	ND		mg/kg	8330	1820	20
2,3-Dimethylhexane	2090	J	mg/kg	8330	2020	20
2-Methylheptane	19200		mg/kg	8330	1930	20
3-Methylheptane	14400		mg/kg	8330	2500	20
3-Ethylhexane	1950	J	mg/kg	8330	2130	20
Toluene	10500		mg/kg	8330	1200	20
2-Methylthiophene	ND		mg/kg	8330	1240	20
3-Methylthiophene	ND		mg/kg	8330	1280	20
1-Octene	ND		mg/kg	20800	1270	20
Octane	71000		mg/kg	8330	1760	20
1,2-Dibromoethane	ND		mg/kg	8330	1330	20
Ethylbenzene	20500		mg/kg	8330	900.	20
2-Ethylthiophene	ND		mg/kg	8330	912.	20
p/m-Xylene	69900		mg/kg	16700	2340	20
1-Nonene	ND		mg/kg	20800	863.	20
Nonane (C9)	333000		mg/kg	8330	1820	20
Styrene	ND		mg/kg	8330	1160	20
o-Xylene	33900		mg/kg	8330	1280	20
Isopropylbenzene	14500		mg/kg	8330	1390	20
n-Propylbenzene	33700		mg/kg	8330	1570	20
1-Methyl-3-Ethylbenzene	84100		mg/kg	8330	1340	20
1-Methyl-4-Ethylbenzene	41100		mg/kg	8330	1520	20
1,3,5-Trimethylbenzene	76800		mg/kg	8330	1580	20
1-Decene	ND		mg/kg	8330	1160	20
1-Methyl-2-Ethylbenzene	44600		mg/kg	8330	1700	20
Decane (C10)	1560000	E	mg/kg	8330	1270	20
1,2,4-Trimethylbenzene	302000		mg/kg	8330	1820	20
sec-Butylbenzene	38300		mg/kg	8330	1690	20
1-Methyl-3-Isopropylbenzene	63500		mg/kg	8330	1570	20
1-Methyl-4-Isopropylbenzene	50800		mg/kg	8330	1910	20

**Project Name:** HAWAII DOH - FINGERPRINTING**Lab Number:** L2240634**Project Number:** Not Specified**Report Date:** 09/08/22**SAMPLE RESULTS**

Lab ID: L2240634-30 D  
 Client ID: JP-5 MEOH (20 MG/ML)  
 Sample Location: Not Specified

Date Collected: 08/17/22 12:15  
 Date Received: 08/17/22  
 Field Prep: Not Specified

Sample Depth:

Parameter	Result	Qualifier	Units	RL	MDL	Dilution Factor
<b>PIANO Volatile Organics by GC/MS - Mansfield Lab</b>						
1-Methyl-2-Isopropylbenzene	9750		mg/kg	8330	2290	20
Indane	15800		mg/kg	8330	1930	20
1-Methyl-3-N-Propylbenzene	164000		mg/kg	8330	1840	20
1-Methyl-4-N-Propylbenzene	73400		mg/kg	8330	1960	20
n-Butylbenzene	77000		mg/kg	8330	2080	20
1,2-Dimethyl-4-Ethylbenzene	134000		mg/kg	8330	2030	20
1,2-Diethylbenzene	18300		mg/kg	8330	1920	20
1-Methyl-2-N-Propylbenzene	78100		mg/kg	8330	1700	20
1,4-Dimethyl-2-Ethylbenzene	95700		mg/kg	8330	1860	20
Undecane	2040000	E	mg/kg	8330	2940	20
1,3-Dimethyl-4-Ethylbenzene	108000		mg/kg	8330	1780	20
1,3-Dimethyl-5-Ethylbenzene	155000		mg/kg	8330	2030	20
1,3-Dimethyl-2-Ethylbenzene	20000		mg/kg	8330	1980	20
1,2-Dimethyl-3-Ethylbenzene	62700		mg/kg	8330	1820	20
1,2,4,5-Tetramethylbenzene	86500		mg/kg	8330	1880	20
N-Pentylbenzene	27500		mg/kg	8330	1650	20
Dodecane (C12)	1890000	E	mg/kg	20800	3660	20
Naphthalene	145000		mg/kg	8330	3470	20
Benzothiophene	ND		mg/kg	8330	4400	20
MMT	ND		mg/kg	20800	5350	20
Tridecane	2100000	E	mg/kg	20800	5400	20
2-Methylnaphthalene	287000		mg/kg	20800	5500	20
1-Methylnaphthalene	200000		mg/kg	20800	6110	20

Surrogate	% Recovery	Qualifier	Acceptance Criteria
Dibromofluoromethane	126		70-130
Toluene-d8	113		70-130
4-Bromofluorobenzene	91		70-130

**Project Name:** HAWAII DOH - FINGERPRINTING**Lab Number:** L2240634**Project Number:** Not Specified**Report Date:** 09/08/22**SAMPLE RESULTS**

Lab ID: L2240634-31 D2

Date Collected: 08/17/22 12:15

Client ID: JP-8 MEOH (20 MG/ML)

Date Received: 08/17/22

Sample Location: Not Specified

Field Prep: Not Specified

Sample Depth:

Matrix: Oil

Analytical Method: 1,8260B(M)

Analytical Date: 08/20/22 13:13

Analyst: RY

Percent Solids: Results reported on an 'AS RECEIVED' basis.

Parameter	Result	Qualifier	Units	RL	MDL	Dilution Factor
PIANO Volatile Organics by GC/MS - Mansfield Lab						
Nonane (C9)	790000		mg/kg	17400	3800	80
Decane (C10)	718000		mg/kg	17400	2650	80
Undecane	552000		mg/kg	17400	6140	80
Dodecane (C12)	444000		mg/kg	43500	7630	80
Tridecane	403000		mg/kg	43500	11300	80

Surrogate	% Recovery	Qualifier	Acceptance Criteria
Dibromofluoromethane	115		70-130
Toluene-d8	109		70-130
4-Bromofluorobenzene	96		70-130

**Project Name:** HAWAII DOH - FINGERPRINTING**Lab Number:** L2240634**Project Number:** Not Specified**Report Date:** 09/08/22**SAMPLE RESULTS**

Lab ID: L2240634-31 D  
 Client ID: JP-8 MEOH (20 MG/ML)  
 Sample Location: Not Specified

Date Collected: 08/17/22 12:15  
 Date Received: 08/17/22  
 Field Prep: Not Specified

Sample Depth:

Matrix: Oil  
 Analytical Method: 1,8260B(M)  
 Analytical Date: 08/19/22 18:15  
 Analyst: RY  
 Percent Solids: Results reported on an 'AS RECEIVED' basis.

Parameter	Result	Qualifier	Units	RL	MDL	Dilution Factor
<b>PIANO Volatile Organics by GC/MS - Mansfield Lab</b>						
Isopentane	ND		mg/kg	4350	1620	20
1-Pentene	ND		mg/kg	4350	1340	20
2-Methyl-1-Butene	ND		mg/kg	4350	1430	20
Pentane	ND		mg/kg	4350	1350	20
trans-2-Pentene	ND		mg/kg	4350	1530	20
cis-2-Pentene	ND		mg/kg	4350	1140	20
Tertiary Butanol	ND		mg/kg	54300	17600	20
Cyclopentane	ND		mg/kg	4350	1130	20
2,3-Dimethylbutane	ND		mg/kg	4350	1790	20
2-Methylpentane	1630	J	mg/kg	4350	1400	20
Methyl tert butyl ether	ND		mg/kg	4350	1350	20
3-Methylpentane	1130	J	mg/kg	4350	843.	20
1-Hexene	ND		mg/kg	4350	1250	20
n-Hexane	2500	J	mg/kg	4350	1270	20
Isopropyl Ether	ND		mg/kg	4350	1190	20
Ethyl-Tert-Butyl-Ether	ND		mg/kg	4350	1130	20
2,2-Dimethylpentane	ND		mg/kg	4350	1120	20
Methylcyclopentane	5650		mg/kg	4350	1320	20
2,4-Dimethylpentane	965	J	mg/kg	4350	1140	20
1,2-Dichloroethane	ND		mg/kg	4350	1320	20
Cyclohexane	7060		mg/kg	4350	1250	20
2-Methylhexane	12700		mg/kg	4350	1010	20
Benzene	2810	J	mg/kg	4350	941.	20
2,3-Dimethylpentane	3790	J	mg/kg	4350	1100	20
Thiophene	ND		mg/kg	4350	1130	20
3-Methylhexane	12700		mg/kg	4350	1140	20
Tertiary-Amyl Methyl Ether	ND		mg/kg	4350	1150	20
1-Heptene/1,2-DMCP (trans)	13400		mg/kg	8700	2660	20



Project Name: HAWAII DOH - FINGERPRINTING

Lab Number: L2240634

Project Number: Not Specified

Report Date: 09/08/22

## SAMPLE RESULTS

Lab ID: L2240634-31 D  
 Client ID: JP-8 MEOH (20 MG/ML)  
 Sample Location: Not Specified

Date Collected: 08/17/22 12:15  
 Date Received: 08/17/22  
 Field Prep: Not Specified

Sample Depth:

Parameter	Result	Qualifier	Units	RL	MDL	Dilution Factor
PIANO Volatile Organics by GC/MS - Mansfield Lab						
Isooctane	ND		mg/kg	4350	1020	20
Heptane	27900		mg/kg	4350	1190	20
Methylcyclohexane	114000		mg/kg	4350	926.	20
2,5-Dimethylhexane	9680		mg/kg	4350	1040	20
2,4-Dimethylhexane	13800		mg/kg	4350	1030	20
2,2,3-Trimethylpentane	ND		mg/kg	4350	1090	20
2,3,4-Trimethylpentane	1310	J	mg/kg	4350	997.	20
2,3,3-Trimethylpentane	670	J	mg/kg	4350	952.	20
2,3-Dimethylhexane	11100		mg/kg	4350	1050	20
2-Methylheptane	85700		mg/kg	4350	1010	20
3-Methylheptane	66400		mg/kg	4350	1310	20
3-Ethylhexane	13600		mg/kg	4350	1110	20
Toluene	66800		mg/kg	4350	629.	20
2-Methylthiophene	ND		mg/kg	4350	647.	20
3-Methylthiophene	ND		mg/kg	4350	670.	20
1-Octene	ND		mg/kg	10900	664.	20
Octane	304000		mg/kg	4350	920.	20
1,2-Dibromoethane	ND		mg/kg	4350	695.	20
Ethylbenzene	117000		mg/kg	4350	469.	20
2-Ethylthiophene	ND		mg/kg	4350	476.	20
p/m-Xylene	575000		mg/kg	8700	1220	20
1-Nonene	ND		mg/kg	10900	450.	20
Nonane (C9)	848000	E	mg/kg	4350	951.	20
Styrene	ND		mg/kg	4350	603.	20
o-Xylene	229000		mg/kg	4350	668.	20
Isopropylbenzene	32800		mg/kg	4350	726.	20
n-Propylbenzene	86700		mg/kg	4350	820.	20
1-Methyl-3-Ethylbenzene	211000		mg/kg	4350	697.	20
1-Methyl-4-Ethylbenzene	94300		mg/kg	4350	791.	20
1,3,5-Trimethylbenzene	151000		mg/kg	4350	826.	20
1-Decene	ND		mg/kg	4350	604.	20
1-Methyl-2-Ethylbenzene	78100		mg/kg	4350	889.	20
Decane (C10)	754000	E	mg/kg	4350	664.	20
1,2,4-Trimethylbenzene	347000		mg/kg	4350	951.	20
sec-Butylbenzene	20100		mg/kg	4350	880.	20
1-Methyl-3-Isopropylbenzene	32100		mg/kg	4350	818.	20
1-Methyl-4-Isopropylbenzene	22100		mg/kg	4350	997.	20

**Project Name:** HAWAII DOH - FINGERPRINTING**Lab Number:** L2240634**Project Number:** Not Specified**Report Date:** 09/08/22**SAMPLE RESULTS**

Lab ID: L2240634-31 D  
 Client ID: JP-8 MEOH (20 MG/ML)  
 Sample Location: Not Specified

Date Collected: 08/17/22 12:15  
 Date Received: 08/17/22  
 Field Prep: Not Specified

Sample Depth:

Parameter	Result	Qualifier	Units	RL	MDL	Dilution Factor
<b>PIANO Volatile Organics by GC/MS - Mansfield Lab</b>						
1-Methyl-2-Isopropylbenzene	5000		mg/kg	4350	1190	20
Indane	61800		mg/kg	4350	1010	20
1-Methyl-3-N-Propylbenzene	79600		mg/kg	4350	959.	20
1-Methyl-4-N-Propylbenzene	37900		mg/kg	4350	1020	20
n-Butylbenzene	46600		mg/kg	4350	1080	20
1,2-Dimethyl-4-Ethylbenzene	66800		mg/kg	4350	1060	20
1,2-Diethylbenzene	7870		mg/kg	4350	1000	20
1-Methyl-2-N-Propylbenzene	35500		mg/kg	4350	885.	20
1,4-Dimethyl-2-Ethylbenzene	39300		mg/kg	4350	969.	20
Undecane	530000	E	mg/kg	4350	1530	20
1,3-Dimethyl-4-Ethylbenzene	42400		mg/kg	4350	930.	20
1,3-Dimethyl-5-Ethylbenzene	60200		mg/kg	4350	1060	20
1,3-Dimethyl-2-Ethylbenzene	9450		mg/kg	4350	1030	20
1,2-Dimethyl-3-Ethylbenzene	20000		mg/kg	4350	947.	20
1,2,4,5-Tetramethylbenzene	30000		mg/kg	4350	982.	20
N-Pentylbenzene	37300		mg/kg	4350	860.	20
Dodecane (C12)	480000	E	mg/kg	10900	1910	20
Naphthalene	88000		mg/kg	4350	1810	20
Benzo thiophene	ND		mg/kg	4350	2300	20
MMT	ND		mg/kg	10900	2790	20
Tridecane	494000	E	mg/kg	10900	2820	20
2-Methylnaphthalene	164000		mg/kg	10900	2870	20
1-Methylnaphthalene	102000		mg/kg	10900	3190	20

Surrogate	% Recovery	Qualifier	Acceptance Criteria
Dibromofluoromethane	121		70-130
Toluene-d8	112		70-130
4-Bromofluorobenzene	94		70-130

**Project Name:** HAWAII DOH - FINGERPRINTING  
**Project Number:** Not Specified

**Lab Number:** L2240634  
**Report Date:** 09/08/22

**SAMPLE RESULTS**

Lab ID: L2240634-32  
 Client ID: WASTE OIL (AUTO)  
 Sample Location: Not Specified

Date Collected: 07/26/22 00:00  
 Date Received: 07/29/22  
 Field Prep: Not Specified

Sample Depth:

Matrix: Oil  
 Analytical Method: 1,8260B(M)  
 Analytical Date: 08/20/22 10:48  
 Analyst: RY  
 Percent Solids: Results reported on an 'AS RECEIVED' basis.

Parameter	Result	Qualifier	Units	RL	MDL	Dilution Factor
<b>PIANO Volatile Organics by GC/MS - Mansfield Lab</b>						
Isopentane	7.62	J	mg/kg	9.92	3.70	1
1-Pentene	ND		mg/kg	9.92	3.07	1
2-Methyl-1-Butene	ND		mg/kg	9.92	3.26	1
Pentane	4.83	J	mg/kg	9.92	3.09	1
trans-2-Pentene	0.928	J	mg/kg	9.92	3.49	1
cis-2-Pentene	ND		mg/kg	9.92	2.60	1
Tertiary Butanol	ND		mg/kg	124	40.2	1
Cyclopentane	1.88	J	mg/kg	9.92	2.57	1
2,3-Dimethylbutane	5.14	J	mg/kg	9.92	4.09	1
2-Methylpentane	19.8		mg/kg	9.92	3.19	1
Methyl tert butyl ether	28.9		mg/kg	9.92	3.09	1
3-Methylpentane	17.1		mg/kg	9.92	1.92	1
1-Hexene	ND		mg/kg	9.92	2.85	1
n-Hexane	23.8		mg/kg	9.92	2.89	1
Isopropyl Ether	ND		mg/kg	9.92	2.72	1
Ethyl-Tert-Butyl-Ether	ND		mg/kg	9.92	2.59	1
2,2-Dimethylpentane	1.93	J	mg/kg	9.92	2.57	1
Methylcyclopentane	22.0		mg/kg	9.92	3.02	1
2,4-Dimethylpentane	5.18	J	mg/kg	9.92	2.60	1
1,2-Dichloroethane	ND		mg/kg	9.92	3.00	1
Cyclohexane	18.0		mg/kg	9.92	2.86	1
2-Methylhexane	39.6		mg/kg	9.92	2.31	1
Benzene	11.2	B	mg/kg	9.92	2.15	1
2,3-Dimethylpentane	14.3		mg/kg	9.92	2.51	1
Thiophene	ND		mg/kg	9.92	2.58	1
3-Methylhexane	44.4		mg/kg	9.92	2.61	1
Tertiary-Amyl Methyl Ether	24.5		mg/kg	9.92	2.63	1
1-Heptene/1,2-DMCP (trans)	14.1	J	mg/kg	19.8	6.08	1

**Project Name:** HAWAII DOH - FINGERPRINTING**Lab Number:** L2240634**Project Number:** Not Specified**Report Date:** 09/08/22**SAMPLE RESULTS**

Lab ID: L2240634-32  
 Client ID: WASTE OIL (AUTO)  
 Sample Location: Not Specified

Date Collected: 07/26/22 00:00  
 Date Received: 07/29/22  
 Field Prep: Not Specified

Sample Depth:

Parameter	Result	Qualifier	Units	RL	MDL	Dilution Factor
<b>PIANO Volatile Organics by GC/MS - Mansfield Lab</b>						
Isooctane	5.61	J	mg/kg	9.92	2.32	1
Heptane	51.7		mg/kg	9.92	2.72	1
Methylcyclohexane	26.8		mg/kg	9.92	2.11	1
2,5-Dimethylhexane	8.76	J	mg/kg	9.92	2.37	1
2,4-Dimethylhexane	13.2		mg/kg	9.92	2.34	1
2,2,3-Trimethylpentane	1.02	J	mg/kg	9.92	2.48	1
2,3,4-Trimethylpentane	6.03	J	mg/kg	9.92	2.27	1
2,3,3-Trimethylpentane	6.70	J	mg/kg	9.92	2.17	1
2,3-Dimethylhexane	11.0		mg/kg	9.92	2.40	1
2-Methylheptane	49.4		mg/kg	9.92	2.30	1
3-Methylheptane	55.7		mg/kg	9.92	2.98	1
3-Ethylhexane	10.5		mg/kg	9.92	2.53	1
Toluene	248		mg/kg	9.92	1.44	1
2-Methylthiophene	ND		mg/kg	9.92	1.48	1
3-Methylthiophene	ND		mg/kg	9.92	1.53	1
1-Octene	ND		mg/kg	24.8	1.51	1
Octane	63.8		mg/kg	9.92	2.10	1
1,2-Dibromoethane	ND		mg/kg	9.92	1.59	1
Ethylbenzene	161		mg/kg	9.92	1.07	1
2-Ethylthiophene	ND		mg/kg	9.92	1.09	1
p/m-Xylene	683		mg/kg	19.8	2.79	1
1-Nonene	ND		mg/kg	24.8	1.03	1
Nonane (C9)	66.4		mg/kg	9.92	2.17	1
Styrene	2.79	J	mg/kg	9.92	1.38	1
o-Xylene	305		mg/kg	9.92	1.52	1
Isopropylbenzene	23.7		mg/kg	9.92	1.66	1
n-Propylbenzene	119		mg/kg	9.92	1.87	1
1-Methyl-3-Ethylbenzene	438		mg/kg	9.92	1.59	1
1-Methyl-4-Ethylbenzene	201		mg/kg	9.92	1.80	1
1,3,5-Trimethylbenzene	237		mg/kg	9.92	1.88	1
1-Decene	ND		mg/kg	9.92	1.38	1
1-Methyl-2-Ethylbenzene	171		mg/kg	9.92	2.03	1
Decane (C10)	42.2		mg/kg	9.92	1.51	1
1,2,4-Trimethylbenzene	880		mg/kg	9.92	2.17	1
sec-Butylbenzene	13.0		mg/kg	9.92	2.01	1
1-Methyl-3-Isopropylbenzene	25.3		mg/kg	9.92	1.86	1
1-Methyl-4-Isopropylbenzene	8.90	J	mg/kg	9.92	2.27	1

**Project Name:** HAWAII DOH - FINGERPRINTING**Lab Number:** L2240634**Project Number:** Not Specified**Report Date:** 09/08/22**SAMPLE RESULTS**

Lab ID: L2240634-32  
 Client ID: WASTE OIL (AUTO)  
 Sample Location: Not Specified

Date Collected: 07/26/22 00:00  
 Date Received: 07/29/22  
 Field Prep: Not Specified

Sample Depth:

Parameter	Result	Qualifier	Units	RL	MDL	Dilution Factor
<b>PIANO Volatile Organics by GC/MS - Mansfield Lab</b>						
1-Methyl-2-Isopropylbenzene	2.33	J	mg/kg	9.92	2.72	1
Indane	150		mg/kg	9.92	2.30	1
1-Methyl-3-N-Propylbenzene	166		mg/kg	9.92	2.19	1
1-Methyl-4-N-Propylbenzene	83.0		mg/kg	9.92	2.33	1
n-Butylbenzene	57.6		mg/kg	9.92	2.48	1
1,2-Dimethyl-4-Ethylbenzene	199		mg/kg	9.92	2.41	1
1,2-Diethylbenzene	13.9		mg/kg	9.92	2.29	1
1-Methyl-2-N-Propylbenzene	59.2		mg/kg	9.92	2.02	1
1,4-Dimethyl-2-Ethylbenzene	153		mg/kg	9.92	2.21	1
Undecane	24.3		mg/kg	9.92	3.50	1
1,3-Dimethyl-4-Ethylbenzene	136		mg/kg	9.92	2.12	1
1,3-Dimethyl-5-Ethylbenzene	260		mg/kg	9.92	2.41	1
1,3-Dimethyl-2-Ethylbenzene	16.5		mg/kg	9.92	2.35	1
1,2-Dimethyl-3-Ethylbenzene	61.3		mg/kg	9.92	2.16	1
1,2,4,5-Tetramethylbenzene	179		mg/kg	9.92	2.24	1
N-Pentylbenzene	22.8		mg/kg	9.92	1.96	1
Dodecane (C12)	23.4	J	mg/kg	24.8	4.35	1
Naphthalene	386		mg/kg	9.92	4.14	1
Benzo thiophene	ND		mg/kg	9.92	5.24	1
MMT	ND		mg/kg	24.8	6.37	1
Tridecane	24.9		mg/kg	24.8	6.43	1
2-Methylnaphthalene	945		mg/kg	24.8	6.55	1
1-Methylnaphthalene	506		mg/kg	24.8	7.28	1

Surrogate	% Recovery	Qualifier	Acceptance Criteria
Dibromofluoromethane	115		70-130
Toluene-d8	112		70-130
4-Bromofluorobenzene	95		70-130

**Project Name:** HAWAII DOH - FINGERPRINTING  
**Project Number:** Not Specified

**Lab Number:** L2240634  
**Report Date:** 09/08/22

### Method Blank Analysis Batch Quality Control

Analytical Method: 1,8260B(M)  
Analytical Date: 08/02/22 17:22  
Analyst: RY

Parameter	Result	Qualifier	Units	RL	MDL
PIANO Volatile Organics by GC/MS - Mansfield Lab for sample(s): 01,04,07,10,13,22,25 Batch: WG1671854-6					
Isopentane	ND		mg/kg	10.0	3.73
1-Pentene	ND		mg/kg	10.0	3.09
2-Methyl-1-Butene	ND		mg/kg	10.0	3.28
Pentane	ND		mg/kg	10.0	3.11
trans-2-Pentene	ND		mg/kg	10.0	3.52
cis-2-Pentene	ND		mg/kg	10.0	2.62
Tertiary Butanol	ND		mg/kg	125	40.5
Cyclopentane	ND		mg/kg	10.0	2.59
2,3-Dimethylbutane	ND		mg/kg	10.0	4.13
2-Methylpentane	ND		mg/kg	10.0	3.22
Methyl tert butyl ether	ND		mg/kg	10.0	3.11
3-Methylpentane	ND		mg/kg	10.0	1.94
1-Hexene	ND		mg/kg	10.0	2.87
n-Hexane	2.60	J	mg/kg	10.0	2.91
Isopropyl Ether	ND		mg/kg	10.0	2.74
Ethyl-Tert-Butyl-Ether	ND		mg/kg	10.0	2.61
2,2-Dimethylpentane	ND		mg/kg	10.0	2.59
Methylcyclopentane	ND		mg/kg	10.0	3.04
2,4-Dimethylpentane	ND		mg/kg	10.0	2.62
1,2-Dichloroethane	ND		mg/kg	10.0	3.03
Cyclohexane	ND		mg/kg	10.0	2.89
2-Methylhexane	ND		mg/kg	10.0	2.33
Benzene	1.58	J	mg/kg	10.0	2.16
2,3-Dimethylpentane	ND		mg/kg	10.0	2.53
Thiophene	ND		mg/kg	10.0	2.60
3-Methylhexane	ND		mg/kg	10.0	2.63
Tertiary-Amyl Methyl Ether	ND		mg/kg	10.0	2.65
1-Heptene/1,2-DMCP (trans)	ND		mg/kg	20.0	6.13
Isooctane	ND		mg/kg	10.0	2.34

Project Name: HAWAII DOH - FINGERPRINTING

Lab Number: L2240634

Project Number: Not Specified

Report Date: 09/08/22

### Method Blank Analysis Batch Quality Control

Analytical Method: 1,8260B(M)  
 Analytical Date: 08/02/22 17:22  
 Analyst: RY

Parameter	Result	Qualifier	Units	RL	MDL
PIANO Volatile Organics by GC/MS - Mansfield Lab for sample(s): 01,04,07,10,13,22,25 Batch: WG1671854-6					
Heptane	ND		mg/kg	10.0	2.74
Methylcyclohexane	ND		mg/kg	10.0	2.13
2,5-Dimethylhexane	ND		mg/kg	10.0	2.39
2,4-Dimethylhexane	ND		mg/kg	10.0	2.36
2,2,3-Trimethylpentane	ND		mg/kg	10.0	2.50
2,3,4-Trimethylpentane	ND		mg/kg	10.0	2.29
2,3,3-Trimethylpentane	ND		mg/kg	10.0	2.19
2,3-Dimethylhexane	ND		mg/kg	10.0	2.42
2-Methylheptane	ND		mg/kg	10.0	2.32
3-Methylheptane	ND		mg/kg	10.0	3.00
3-Ethylhexane	ND		mg/kg	10.0	2.55
Toluene	ND		mg/kg	10.0	1.45
2-Methylthiophene	ND		mg/kg	10.0	1.49
3-Methylthiophene	ND		mg/kg	10.0	1.54
1-Octene	ND		mg/kg	25.0	1.53
Octane	ND		mg/kg	10.0	2.12
1,2-Dibromoethane	ND		mg/kg	10.0	1.60
Ethylbenzene	ND		mg/kg	10.0	1.08
2-Ethylthiophene	ND		mg/kg	10.0	1.09
p/m-Xylene	ND		mg/kg	20.0	2.81
1-Nonene	ND		mg/kg	25.0	1.04
Nonane (C9)	ND		mg/kg	10.0	2.19
Styrene	ND		mg/kg	10.0	1.39
o-Xylene	ND		mg/kg	10.0	1.54
Isopropylbenzene	ND		mg/kg	10.0	1.67
n-Propylbenzene	ND		mg/kg	10.0	1.89
1-Methyl-3-Ethylbenzene	ND		mg/kg	10.0	1.60
1-Methyl-4-Ethylbenzene	ND		mg/kg	10.0	1.82
1,3,5-Trimethylbenzene	ND		mg/kg	10.0	1.90

Project Name: HAWAII DOH - FINGERPRINTING

Lab Number: L2240634

Project Number: Not Specified

Report Date: 09/08/22

### Method Blank Analysis Batch Quality Control

Analytical Method: 1,8260B(M)  
 Analytical Date: 08/02/22 17:22  
 Analyst: RY

Parameter	Result	Qualifier	Units	RL	MDL
PIANO Volatile Organics by GC/MS - Mansfield Lab for sample(s): 01,04,07,10,13,22,25 Batch: WG1671854-6					
1-Decene	ND		mg/kg	10.0	1.39
1-Methyl-2-Ethylbenzene	ND		mg/kg	10.0	2.04
Decane (C10)	ND		mg/kg	10.0	1.53
1,2,4-Trimethylbenzene	ND		mg/kg	10.0	2.19
sec-Butylbenzene	ND		mg/kg	10.0	2.02
1-Methyl-3-Isopropylbenzene	ND		mg/kg	10.0	1.88
1-Methyl-4-Isopropylbenzene	ND		mg/kg	10.0	2.29
1-Methyl-2-Isopropylbenzene	ND		mg/kg	10.0	2.74
Indane	ND		mg/kg	10.0	2.31
1-Methyl-3-N-Propylbenzene	ND		mg/kg	10.0	2.20
1-Methyl-4-N-Propylbenzene	ND		mg/kg	10.0	2.35
n-Butylbenzene	ND		mg/kg	10.0	2.50
1,2-Dimethyl-4-Ethylbenzene	ND		mg/kg	10.0	2.43
1,2-Diethylbenzene	ND		mg/kg	10.0	2.31
1-Methyl-2-N-Propylbenzene	ND		mg/kg	10.0	2.04
1,4-Dimethyl-2-Ethylbenzene	ND		mg/kg	10.0	2.23
Undecane	ND		mg/kg	10.0	3.53
1,3-Dimethyl-4-Ethylbenzene	ND		mg/kg	10.0	2.14
1,3-Dimethyl-5-Ethylbenzene	ND		mg/kg	10.0	2.43
1,3-Dimethyl-2-Ethylbenzene	ND		mg/kg	10.0	2.37
1,2-Dimethyl-3-Ethylbenzene	ND		mg/kg	10.0	2.18
1,2,4,5-Tetramethylbenzene	ND		mg/kg	10.0	2.26
N-Pentylbenzene	ND		mg/kg	10.0	1.98
Dodecane (C12)	ND		mg/kg	25.0	4.39
Naphthalene	ND		mg/kg	10.0	4.17
Benzothiophene	ND		mg/kg	10.0	5.28
MMT	ND		mg/kg	25.0	6.42
Tridecane	ND		mg/kg	25.0	6.48
2-Methylnaphthalene	0.870	J	mg/kg	25.0	6.60



**Project Name:** HAWAII DOH - FINGERPRINTING  
**Project Number:** Not Specified

**Lab Number:** L2240634  
**Report Date:** 09/08/22

**Method Blank Analysis  
Batch Quality Control**

Analytical Method: 1,8260B(M)  
Analytical Date: 08/02/22 17:22  
Analyst: RY

Parameter	Result	Qualifier	Units	RL	MDL
PIANO Volatile Organics by GC/MS - Mansfield Lab for sample(s): 01,04,07,10,13,22,25 Batch: WG1671854-6					
1-Methylnaphthalene	0.600	J	mg/kg	25.0	7.33

Surrogate	%Recovery	Qualifier	Acceptance Criteria
Dibromofluoromethane	122		70-130
Toluene-d8	111		70-130
4-Bromofluorobenzene	95		70-130

Project Name: HAWAII DOH - FINGERPRINTING

Lab Number: L2240634

Project Number: Not Specified

Report Date: 09/08/22

### Method Blank Analysis Batch Quality Control

Analytical Method: 1,8260B(M)  
 Analytical Date: 08/17/22 04:45  
 Analyst: RY

Parameter	Result	Qualifier	Units	RL	MDL
PIANO Volatile Organics by GC/MS - Mansfield Lab for sample(s): 30-32 Batch: WG1677380-6					
Isopentane	ND		mg/kg	10.0	3.73
1-Pentene	ND		mg/kg	10.0	3.09
2-Methyl-1-Butene	ND		mg/kg	10.0	3.28
Pentane	ND		mg/kg	10.0	3.11
trans-2-Pentene	ND		mg/kg	10.0	3.52
cis-2-Pentene	ND		mg/kg	10.0	2.62
Tertiary Butanol	ND		mg/kg	125	40.5
Cyclopentane	ND		mg/kg	10.0	2.59
2,3-Dimethylbutane	ND		mg/kg	10.0	4.13
2-Methylpentane	ND		mg/kg	10.0	3.22
Methyl tert butyl ether	ND		mg/kg	10.0	3.11
3-Methylpentane	ND		mg/kg	10.0	1.94
1-Hexene	ND		mg/kg	10.0	2.87
n-Hexane	ND		mg/kg	10.0	2.91
Isopropyl Ether	ND		mg/kg	10.0	2.74
Ethyl-Tert-Butyl-Ether	ND		mg/kg	10.0	2.61
2,2-Dimethylpentane	ND		mg/kg	10.0	2.59
Methylcyclopentane	ND		mg/kg	10.0	3.04
2,4-Dimethylpentane	ND		mg/kg	10.0	2.62
1,2-Dichloroethane	ND		mg/kg	10.0	3.03
Cyclohexane	ND		mg/kg	10.0	2.89
2-Methylhexane	ND		mg/kg	10.0	2.33
Benzene	1.93	J	mg/kg	10.0	2.16
2,3-Dimethylpentane	ND		mg/kg	10.0	2.53
Thiophene	ND		mg/kg	10.0	2.60
3-Methylhexane	ND		mg/kg	10.0	2.63
Tertiary-Amyl Methyl Ether	ND		mg/kg	10.0	2.65
1-Heptene/1,2-DMCP (trans)	ND		mg/kg	20.0	6.13
Isooctane	ND		mg/kg	10.0	2.34

**Project Name:** HAWAII DOH - FINGERPRINTING  
**Project Number:** Not Specified

**Lab Number:** L2240634  
**Report Date:** 09/08/22

**Method Blank Analysis**  
**Batch Quality Control**

Analytical Method: 1,8260B(M)  
Analytical Date: 08/17/22 04:45  
Analyst: RY

Parameter	Result	Qualifier	Units	RL	MDL
PIANO Volatile Organics by GC/MS - Mansfield Lab for sample(s): 30-32 Batch: WG1677380-6					
Heptane	ND		mg/kg	10.0	2.74
Methylcyclohexane	ND		mg/kg	10.0	2.13
2,5-Dimethylhexane	ND		mg/kg	10.0	2.39
2,4-Dimethylhexane	ND		mg/kg	10.0	2.36
2,2,3-Trimethylpentane	ND		mg/kg	10.0	2.50
2,3,4-Trimethylpentane	ND		mg/kg	10.0	2.29
2,3,3-Trimethylpentane	ND		mg/kg	10.0	2.19
2,3-Dimethylhexane	ND		mg/kg	10.0	2.42
2-Methylheptane	ND		mg/kg	10.0	2.32
3-Methylheptane	ND		mg/kg	10.0	3.00
3-Ethylhexane	ND		mg/kg	10.0	2.55
Toluene	0.530	J	mg/kg	10.0	1.45
2-Methylthiophene	ND		mg/kg	10.0	1.49
3-Methylthiophene	ND		mg/kg	10.0	1.54
1-Octene	ND		mg/kg	25.0	1.53
Octane	ND		mg/kg	10.0	2.12
1,2-Dibromoethane	ND		mg/kg	10.0	1.60
Ethylbenzene	ND		mg/kg	10.0	1.08
2-Ethylthiophene	ND		mg/kg	10.0	1.09
p/m-Xylene	0.680	J	mg/kg	20.0	2.81
1-Nonene	ND		mg/kg	25.0	1.04
Nonane (C9)	ND		mg/kg	10.0	2.19
Styrene	ND		mg/kg	10.0	1.39
o-Xylene	0.425	J	mg/kg	10.0	1.54
Isopropylbenzene	ND		mg/kg	10.0	1.67
n-Propylbenzene	ND		mg/kg	10.0	1.89
1-Methyl-3-Ethylbenzene	ND		mg/kg	10.0	1.60
1-Methyl-4-Ethylbenzene	ND		mg/kg	10.0	1.82
1,3,5-Trimethylbenzene	ND		mg/kg	10.0	1.90

Project Name: HAWAII DOH - FINGERPRINTING

Lab Number: L2240634

Project Number: Not Specified

Report Date: 09/08/22

### Method Blank Analysis Batch Quality Control

Analytical Method: 1,8260B(M)  
 Analytical Date: 08/17/22 04:45  
 Analyst: RY

Parameter	Result	Qualifier	Units	RL	MDL
PIANO Volatile Organics by GC/MS - Mansfield Lab for sample(s): 30-32 Batch: WG1677380-6					
1-Decene	ND		mg/kg	10.0	1.39
1-Methyl-2-Ethylbenzene	ND		mg/kg	10.0	2.04
Decane (C10)	1.36	J	mg/kg	10.0	1.53
1,2,4-Trimethylbenzene	0.295	J	mg/kg	10.0	2.19
sec-Butylbenzene	ND		mg/kg	10.0	2.02
1-Methyl-3-Isopropylbenzene	ND		mg/kg	10.0	1.88
1-Methyl-4-Isopropylbenzene	ND		mg/kg	10.0	2.29
1-Methyl-2-Isopropylbenzene	ND		mg/kg	10.0	2.74
Indane	ND		mg/kg	10.0	2.31
1-Methyl-3-N-Propylbenzene	ND		mg/kg	10.0	2.20
1-Methyl-4-N-Propylbenzene	ND		mg/kg	10.0	2.35
n-Butylbenzene	ND		mg/kg	10.0	2.50
1,2-Dimethyl-4-Ethylbenzene	ND		mg/kg	10.0	2.43
1,2-Diethylbenzene	ND		mg/kg	10.0	2.31
1-Methyl-2-N-Propylbenzene	ND		mg/kg	10.0	2.04
1,4-Dimethyl-2-Ethylbenzene	ND		mg/kg	10.0	2.23
Undecane	ND		mg/kg	10.0	3.53
1,3-Dimethyl-4-Ethylbenzene	ND		mg/kg	10.0	2.14
1,3-Dimethyl-5-Ethylbenzene	ND		mg/kg	10.0	2.43
1,3-Dimethyl-2-Ethylbenzene	ND		mg/kg	10.0	2.37
1,2-Dimethyl-3-Ethylbenzene	ND		mg/kg	10.0	2.18
1,2,4,5-Tetramethylbenzene	ND		mg/kg	10.0	2.26
N-Pentylbenzene	ND		mg/kg	10.0	1.98
Dodecane (C12)	ND		mg/kg	25.0	4.39
Naphthalene	0.750	J	mg/kg	10.0	4.17
Benzothiophene	ND		mg/kg	10.0	5.28
MMT	ND		mg/kg	25.0	6.42
Tridecane	ND		mg/kg	25.0	6.48
2-Methylnaphthalene	0.760	J	mg/kg	25.0	6.60

**Project Name:** HAWAII DOH - FINGERPRINTING**Lab Number:** L2240634**Project Number:** Not Specified**Report Date:** 09/08/22**Method Blank Analysis  
Batch Quality Control**

Analytical Method: 1,8260B(M)  
 Analytical Date: 08/17/22 04:45  
 Analyst: RY

Parameter	Result	Qualifier	Units	RL	MDL
PIANO Volatile Organics by GC/MS - Mansfield Lab for sample(s): 30-32 Batch: WG1677380-6					
1-Methylnaphthalene	0.445	J	mg/kg	25.0	7.33

Surrogate	%Recovery	Qualifier	Acceptance Criteria
Dibromofluoromethane	118		70-130
Toluene-d8	110		70-130
4-Bromofluorobenzene	95		70-130

## Lab Control Sample Analysis

### Batch Quality Control

**Project Name:** HAWAII DOH - FINGERPRINTING

**Lab Number:** L2240634

**Project Number:** Not Specified

**Report Date:** 09/08/22

Parameter	LCS		LCSD		%Recovery		RPD	RPD	
	%Recovery	Qual	%Recovery	Qual	Limits	Qual		Limits	
PIANO Volatile Organics by GC/MS - Mansfield Lab Associated sample(s): 01,04,07,10,13,22,25 Batch: WG1671854-3 WG1671854-4									
1-Pentene	110		118		50-130	7		30	
Pentane	92		96		50-130	4		30	
Tertiary Butanol	106		106		50-130	0		30	
Cyclopentane	91		100		50-130	9		30	
2-Methylpentane	95		102		50-130	7		30	
Methyl tert butyl ether	90		94		50-130	4		30	
3-Methylpentane	98		104		50-130	6		30	
1-Hexene	104		109		50-130	5		30	
n-Hexane	97		102		50-130	5		30	
Isopropyl Ether	94		96		50-130	2		30	
Ethyl-Tert-Butyl-Ether	82		74		50-130	10		30	
Methylcyclopentane	102		108		50-130	6		30	
2,4-Dimethylpentane	96		103		50-130	7		30	
Cyclohexane	102		107		50-130	5		30	
2-Methylhexane	95		101		50-130	6		30	
Benzene	95		98		50-130	3		30	
2,3-Dimethylpentane	97		103		50-130	6		30	
3-Methylhexane	83		94		50-130	12		30	
Tertiary-Amyl Methyl Ether	89		92		50-130	3		30	
Isooctane	104		107		50-130	3		30	
Heptane	103		109		50-130	6		30	
Methylcyclohexane	102		103		50-130	1		30	
2-Methylheptane	102		104		50-130	2		30	

## Lab Control Sample Analysis

### Batch Quality Control

**Project Name:** HAWAII DOH - FINGERPRINTING

**Lab Number:** L2240634

**Project Number:** Not Specified

**Report Date:** 09/08/22

Parameter	LCS		LCSD		%Recovery		RPD	
	%Recovery	Qual	%Recovery	Qual	Limits	RPD	Qual	Limits
PIANO Volatile Organics by GC/MS - Mansfield Lab Associated sample(s): 01,04,07,10,13,22,25 Batch: WG1671854-3 WG1671854-4								
3-Methylheptane	101		103		50-130	2		30
Toluene	96		98		50-130	2		30
Octane	106		106		50-130	0		30
Ethylbenzene	96		99		50-130	3		30
p/m-Xylene	100		102		50-130	2		30
Nonane (C9)	98		97		50-130	1		30
o-Xylene	100		101		50-130	1		30
Isopropylbenzene	101		101		50-130	0		30
n-Propylbenzene	103		103		50-130	0		30
1-Methyl-3-Ethylbenzene	101		101		50-130	0		30
1-Methyl-4-Ethylbenzene	104		104		50-130	0		30
1,3,5-Trimethylbenzene	104		104		50-130	0		30
1-Decene	82		82		50-130	0		30
1-Methyl-2-Ethylbenzene	102		103		50-130	1		30
Decane (C10)	101		102		50-130	1		30
1,2,4-Trimethylbenzene	98		97		50-130	1		30
sec-Butylbenzene	106		105		50-130	1		30
1-Methyl-4-N-Propylbenzene	98		97		50-130	1		30
n-Butylbenzene	99		99		50-130	0		30
1,2-Diethylbenzene	98		97		50-130	1		30
Undecane	83		88		50-130	6		30
N-Pentylbenzene	96		97		50-130	1		30
Dodecane (C12)	91		96		50-130	5		30

## Lab Control Sample Analysis

### Batch Quality Control

**Project Name:** HAWAII DOH - FINGERPRINTING

**Lab Number:** L2240634

**Project Number:** Not Specified

**Report Date:** 09/08/22

Parameter	<i>LCS</i> %Recovery	<i>Qual</i>	<i>LCSD</i> %Recovery	<i>Qual</i>	<i>%Recovery</i> Limits	<i>RPD</i>	<i>Qual</i>	<i>RPD</i> Limits
-----------	-------------------------	-------------	--------------------------	-------------	----------------------------	------------	-------------	----------------------

PIANO Volatile Organics by GC/MS - Mansfield Lab Associated sample(s): 01,04,07,10,13,22,25 Batch: WG1671854-3 WG1671854-4

<i>Surrogate</i>	<i>LCS</i> %Recovery	<i>Qual</i>	<i>LCSD</i> %Recovery	<i>Qual</i>	<i>Acceptance</i> <i>Criteria</i>
Dibromofluoromethane	123		123		70-130
Toluene-d8	114		114		70-130
4-Bromofluorobenzene	94		94		70-130



## Lab Control Sample Analysis

### Batch Quality Control

**Project Name:** HAWAII DOH - FINGERPRINTING

**Lab Number:** L2240634

**Project Number:** Not Specified

**Report Date:** 09/08/22

Parameter	LCS		LCSD		%Recovery		RPD	RPD	
	%Recovery	Qual	%Recovery	Qual	Limits	Qual		Limits	
PIANO Volatile Organics by GC/MS - Mansfield Lab Associated sample(s): 30-32 Batch: WG1677380-3 WG1677380-4									
1-Pentene	94		105		50-130		11		30
Pentane	75		85		50-130		13		30
Tertiary Butanol	101		98		50-130		3		30
Cyclopentane	83		92		50-130		10		30
2-Methylpentane	84		92		50-130		9		30
Methyl tert butyl ether	83		84		50-130		1		30
3-Methylpentane	86		95		50-130		10		30
1-Hexene	93		99		50-130		6		30
n-Hexane	84		92		50-130		9		30
Isopropyl Ether	88		89		50-130		1		30
Ethyl-Tert-Butyl-Ether	78		78		50-130		0		30
Methylcyclopentane	93		101		50-130		8		30
2,4-Dimethylpentane	85		93		50-130		9		30
Cyclohexane	96		102		50-130		6		30
2-Methylhexane	87		95		50-130		9		30
Benzene	92		93		50-130		1		30
2,3-Dimethylpentane	89		96		50-130		8		30
3-Methylhexane	78		85		50-130		9		30
Tertiary-Amyl Methyl Ether	84		84		50-130		0		30
Isooctane	94		100		50-130		6		30
Heptane	94		102		50-130		8		30
Methylcyclohexane	94		96		50-130		2		30
2-Methylheptane	100		104		50-130		4		30

## Lab Control Sample Analysis

### Batch Quality Control

**Project Name:** HAWAII DOH - FINGERPRINTING

**Lab Number:** L2240634

**Project Number:** Not Specified

**Report Date:** 09/08/22

Parameter	LCS		LCSD		%Recovery		RPD	RPD	
	%Recovery	Qual	%Recovery	Qual	Limits	Qual		Limits	
PIANO Volatile Organics by GC/MS - Mansfield Lab Associated sample(s): 30-32 Batch: WG1677380-3 WG1677380-4									
3-Methylheptane	98		104		50-130		6		30
Toluene	94		95		50-130		1		30
Octane	101		106		50-130		5		30
Ethylbenzene	95		97		50-130		2		30
p/m-Xylene	100		101		50-130		1		30
Nonane (C9)	97		101		50-130		4		30
o-Xylene	99		101		50-130		2		30
Isopropylbenzene	102		103		50-130		1		30
n-Propylbenzene	105		106		50-130		1		30
1-Methyl-3-Ethylbenzene	103		104		50-130		1		30
1-Methyl-4-Ethylbenzene	106		108		50-130		2		30
1,3,5-Trimethylbenzene	105		106		50-130		1		30
1-Decene	81		86		50-130		6		30
1-Methyl-2-Ethylbenzene	104		106		50-130		2		30
Decane (C10)	105		110		50-130		5		30
1,2,4-Trimethylbenzene	99		101		50-130		2		30
sec-Butylbenzene	110		111		50-130		1		30
1-Methyl-4-N-Propylbenzene	102		102		50-130		0		30
n-Butylbenzene	103		104		50-130		1		30
1,2-Diethylbenzene	102		104		50-130		2		30
Undecane	96		105		50-130		9		30
N-Pentylbenzene	101		103		50-130		2		30
Dodecane (C12)	112		126		50-130		12		30

## Lab Control Sample Analysis

### Batch Quality Control

**Project Name:** HAWAII DOH - FINGERPRINTING

**Project Number:** Not Specified

**Lab Number:** L2240634

**Report Date:** 09/08/22

Parameter	<i>LCS</i> %Recovery	<i>Qual</i>	<i>LCSD</i> %Recovery	<i>Qual</i>	<i>%Recovery</i> Limits	<i>RPD</i>	<i>Qual</i>	<i>RPD</i> Limits
-----------	-------------------------	-------------	--------------------------	-------------	----------------------------	------------	-------------	----------------------

PIANO Volatile Organics by GC/MS - Mansfield Lab Associated sample(s): 30-32 Batch: WG1677380-3 WG1677380-4

<i>Surrogate</i>	<i>LCS</i> %Recovery	<i>Qual</i>	<i>LCSD</i> %Recovery	<i>Qual</i>	<i>Acceptance</i> Criteria
Dibromofluoromethane	116		118		70-130
Toluene-d8	110		110		70-130
4-Bromofluorobenzene	96		97		70-130

## Lab Duplicate Analysis

Batch Quality Control

Project Name: HAWAII DOH - FINGERPRINTING

Project Number: Not Specified

Lab Number: L2240634

Report Date: 09/08/22

Parameter	Native Sample	Duplicate Sample	Units	RPD	Qual	RPD Limits
PIANO Volatile Organics by GC/MS - Mansfield Lab Associated sample(s): 01,04,07,10,13,22,25 QC Batch ID: WG1671854-7 QC Sample: L2240634-01 Client ID: GASOLINE 87						
Isopentane	58500E	58500E	mg/kg	0		30
1-Pentene	2220	2630	mg/kg	17		30
2-Methyl-1-Butene	5550	5450	mg/kg	2		30
Pentane	43500E	43100E	mg/kg	1		30
trans-2-Pentene	6310	6150	mg/kg	3		30
cis-2-Pentene	3660	3870	mg/kg	6		30
Tertiary Butanol	ND	ND	mg/kg	NC		30
Cyclopentane	4880	4990	mg/kg	2		30
2,3-Dimethylbutane	7760	7600	mg/kg	2		30
2-Methylpentane	35800E	35400E	mg/kg	1		30
Methyl tert butyl ether	ND	ND	mg/kg	NC		30
3-Methylpentane	22700E	22400E	mg/kg	1		30
1-Hexene	820	703	mg/kg	15		30
n-Hexane	33300E	33000E	mg/kg	1		30
Isopropyl Ether	ND	ND	mg/kg	NC		30
Ethyl-Tert-Butyl-Ether	ND	ND	mg/kg	NC		30
2,2-Dimethylpentane	1230	1230	mg/kg	0		30
Methylcyclopentane	22200E	21900E	mg/kg	1		30
2,4-Dimethylpentane	4700	4510	mg/kg	4		30
1,2-Dichloroethane	ND	ND	mg/kg	NC		30
Cyclohexane	14600E	14200E	mg/kg	3		30

## Lab Duplicate Analysis

Batch Quality Control

Project Name: HAWAII DOH - FINGERPRINTING

Project Number: Not Specified

Lab Number: L2240634

Report Date: 09/08/22

Parameter	Native Sample	Duplicate Sample	Units	RPD	Qual	RPD Limits
PIANO Volatile Organics by GC/MS - Mansfield Lab Associated sample(s): 01,04,07,10,13,22,25 QC Batch ID: WG1671854-7 QC Sample: L2240634-01						
Client ID: GASOLINE 87						
2-Methylhexane	16200E	16200E	mg/kg	0		30
Benzene	9120	9230	mg/kg	1		30
2,3-Dimethylpentane	7000	6750	mg/kg	4		30
Thiophene	ND	ND	mg/kg	NC		30
3-Methylhexane	15900E	15900E	mg/kg	0		30
Tertiary-Amyl Methyl Ether	ND	ND	mg/kg	NC		30
1-Heptene/1,2-DMCP (trans)	8560	8780	mg/kg	3		30
Isooctane	15100E	15600E	mg/kg	3		30
Heptane	19000E	19800E	mg/kg	4		30
Methylcyclohexane	14900E	15600E	mg/kg	5		30
2,5-Dimethylhexane	3420	3920	mg/kg	14		30
2,4-Dimethylhexane	3390	3640	mg/kg	7		30
2,2,3-Trimethylpentane	1010	1120	mg/kg	10		30
2,3,4-Trimethylpentane	7030	7840	mg/kg	11		30
2,3,3-Trimethylpentane	7790	8830	mg/kg	13		30
2,3-Dimethylhexane	2140	2270	mg/kg	6		30
2-Methylheptane	8310	10300E	mg/kg	21		30
3-Methylheptane	6270	7340	mg/kg	16		30
3-Ethylhexane	1610	1730	mg/kg	7		30
Toluene	54500E	56700E	mg/kg	4		30
2-Methylthiophene	ND	ND	mg/kg	NC		30

## Lab Duplicate Analysis

Batch Quality Control

Project Name: HAWAII DOH - FINGERPRINTING

Project Number: Not Specified

Lab Number: L2240634

Report Date: 09/08/22

Parameter	Native Sample	Duplicate Sample	Units	RPD	Qual	RPD Limits
PIANO Volatile Organics by GC/MS - Mansfield Lab Associated sample(s): 01,04,07,10,13,22,25 QC Batch ID: WG1671854-7 QC Sample: L2240634-01						
Client ID: GASOLINE 87						
3-Methylthiophene	ND	ND	mg/kg	NC		30
1-Octene	ND	ND	mg/kg	NC		30
Octane	9010	10600E	mg/kg	16		30
1,2-Dibromoethane	ND	ND	mg/kg	NC		30
Ethylbenzene	12400E	13600E	mg/kg	9		30
2-Ethylthiophene	ND	ND	mg/kg	NC		30
p/m-Xylene	47000E	52100E	mg/kg	10		30
1-Nonene	ND	ND	mg/kg	NC		30
Nonane (C9)	3940	5100	mg/kg	26		30
Styrene	16.2J	18.8J	mg/kg	NC		30
o-Xylene	17600E	19500E	mg/kg	10		30
Isopropylbenzene	1000	1180	mg/kg	17		30
n-Propylbenzene	3720	4520	mg/kg	19		30
1-Methyl-3-Ethylbenzene	11200E	13600E	mg/kg	19		30
1-Methyl-4-Ethylbenzene	5210	6350	mg/kg	20		30
1,3,5-Trimethylbenzene	5520	6840	mg/kg	21		30
1-Decene	ND	ND	mg/kg	NC		30
1-Methyl-2-Ethylbenzene	4020	4880	mg/kg	19		30
Decane (C10)	2190	2920	mg/kg	29		30
1,2,4-Trimethylbenzene	17900E	21700E	mg/kg	19		30
sec-Butylbenzene	338	429	mg/kg	24		30

## Lab Duplicate Analysis

### Batch Quality Control

**Project Name:** HAWAII DOH - FINGERPRINTING

**Project Number:** Not Specified

**Lab Number:** L2240634

**Report Date:** 09/08/22

Parameter	Native Sample	Duplicate Sample	Units	RPD	Qual	RPD Limits
PIANO Volatile Organics by GC/MS - Mansfield Lab Associated sample(s): 01,04,07,10,13,22,25 QC Batch ID: WG1671854-7 QC Sample: L2240634-01						
Client ID: GASOLINE 87						
1-Methyl-3-Isopropylbenzene	536	684	mg/kg	24		30
1-Methyl-4-Isopropylbenzene	179	230	mg/kg	25		30
1-Methyl-2-Isopropylbenzene	38.6J	49.5J	mg/kg	NC		30
Indane	1870	2190	mg/kg	16		30
1-Methyl-3-N-Propylbenzene	2200	2860	mg/kg	26		30
1-Methyl-4-N-Propylbenzene	1040	1360	mg/kg	27		30
n-Butylbenzene	717	941	mg/kg	27		30
1,2-Dimethyl-4-Ethylbenzene	2190	2840	mg/kg	26		30
1,2-Diethylbenzene	158	202	mg/kg	24		30
1-Methyl-2-N-Propylbenzene	779	1000	mg/kg	25		30
1,4-Dimethyl-2-Ethylbenzene	1550	1970	mg/kg	24		30
Undecane	758	988	mg/kg	26		30
1,3-Dimethyl-4-Ethylbenzene	1300	1670	mg/kg	25		30
1,3-Dimethyl-5-Ethylbenzene	2430	3090	mg/kg	24		30
1,3-Dimethyl-2-Ethylbenzene	166	203	mg/kg	20		30
1,2-Dimethyl-3-Ethylbenzene	511	640	mg/kg	22		30
1,2,4,5-Tetramethylbenzene	1220	1600	mg/kg	27		30
N-Pentylbenzene	91.9J	119	mg/kg	NC		30
Dodecane (C12)	341	425	mg/kg	22		30
Naphthalene	1850	2090	mg/kg	12		30
Benzothiophene	ND	ND	mg/kg	NC		30

## Lab Duplicate Analysis

Batch Quality Control

Project Name: HAWAII DOH - FINGERPRINTING

Project Number: Not Specified

Lab Number: L2240634

Report Date: 09/08/22

Parameter	Native Sample	Duplicate Sample	Units	RPD	Qual	RPD Limits
PIANO Volatile Organics by GC/MS - Mansfield Lab Associated sample(s): 01,04,07,10,13,22,25 QC Batch ID: WG1671854-7 QC Sample: L2240634-01 Client ID: GASOLINE 87						
MMT	ND	ND	mg/kg	NC		30
Tridecane	181J	253	mg/kg	NC		30
2-Methylnaphthalene	1040	1250	mg/kg	18		30
1-Methylnaphthalene	488	577	mg/kg	17		30

Surrogate	%Recovery	Qualifier	%Recovery	Qualifier	Acceptance Criteria
Dibromofluoromethane	127		120		70-130
Toluene-d8	115		111		70-130
4-Bromofluorobenzene	92		95		70-130



## Lab Duplicate Analysis

Batch Quality Control

Project Name: HAWAII DOH - FINGERPRINTING

Project Number: Not Specified

Lab Number: L2240634

Report Date: 09/08/22

Parameter	Native Sample	Duplicate Sample	Units	RPD	Qual	RPD Limits
PIANO Volatile Organics by GC/MS - Mansfield Lab Associated sample(s): 01,04,07,10,13,22,25 QC Batch ID: WG1671854-7 QC Sample: L2240634-01 Client ID: GASOLINE 87						
Isopentane	37900	37000	mg/kg	2		30
Pentane	30300	28500	mg/kg	6		30
2-Methylpentane	26800	25600	mg/kg	5		30
3-Methylpentane	17800	16600	mg/kg	7		30
n-Hexane	26700	24300	mg/kg	9		30
Methylcyclopentane	18800	17500	mg/kg	7		30
Cyclohexane	12700	11800	mg/kg	7		30
2-Methylhexane	14500	13200	mg/kg	9		30
3-Methylhexane	14800	13200	mg/kg	11		30
Isooctane	14900	13600	mg/kg	9		30
Heptane	18700	16900	mg/kg	10		30
Methylcyclohexane	14300	13600	mg/kg	5		30
2-Methylheptane	8310	8080	mg/kg	3		30
Toluene	50200	49400	mg/kg	2		30
Octane	9010	9270	mg/kg	3		30
Ethylbenzene	11800	11600	mg/kg	2		30
p/m-Xylene	46400	45600	mg/kg	2		30
o-Xylene	16800	16500	mg/kg	2		30
1-Methyl-3-Ethylbenzene	11900	11800	mg/kg	1		30
1,2,4-Trimethylbenzene	19200	19200	mg/kg	0		30

**Lab Duplicate Analysis**  
**Batch Quality Control**

**Project Name:** HAWAII DOH - FINGERPRINTING

**Project Number:** Not Specified

**Lab Number:** L2240634

**Report Date:** 09/08/22

Parameter	Native Sample	Duplicate Sample	Units	RPD	Qual	RPD Limits
PIANO Volatile Organics by GC/MS - Mansfield Lab Associated sample(s): 01,04,07,10,13,22,25 QC Batch ID: WG1671854-7 QC Sample: L2240634-01						
Client ID: GASOLINE 87						

Surrogate	%Recovery	Qualifier	%Recovery	Qualifier	Acceptance Criteria
Dibromofluoromethane	124		123		70-130
Toluene-d8	112		113		70-130
4-Bromofluorobenzene	96		95		70-130

# PETROLEUM HYDROCARBONS

**Project Name:** HAWAII DOH - FINGERPRINTING  
**Project Number:** Not Specified

**Lab Number:** L2240634  
**Report Date:** 09/08/22

**SAMPLE RESULTS**

Lab ID: L2240634-01  
 Client ID: GASOLINE 87  
 Sample Location: Not Specified

Date Collected: 07/26/22 00:00  
 Date Received: 07/29/22  
 Field Prep: Not Specified

Sample Depth:

Matrix: Oil  
 Analytical Method: 1,8015D(M)  
 Analytical Date: 08/18/22 01:41  
 Analyst: WR  
 Percent Solids: Results reported on an 'AS RECEIVED' basis.

Extraction Method: EPA 3580A  
 Extraction Date: 08/17/22 10:45

Parameter	Result	Qualifier	Units	RL	MDL	Dilution Factor
<b>Total Petroleum Hydrocarbon by GC-FID - Mansfield Lab</b>						
Total Petroleum Hydrocarbons (C9-C44)	169000		mg/kg	6260	57.8	1

Surrogate	% Recovery	Qualifier	Acceptance Criteria
o-Terphenyl	102		50-130
d50-Tetracosane	100		50-130

**Project Name:** HAWAII DOH - FINGERPRINTING**Lab Number:** L2240634**Project Number:** Not Specified**Report Date:** 09/08/22**SAMPLE RESULTS**

Lab ID: L2240634-02

Date Collected: 07/26/22 00:00

Client ID: GASOLINE 87 F1

Date Received: 07/29/22

Sample Location: Not Specified

Field Prep: Not Specified

Sample Depth:

Matrix: Oil

Extraction Method: EPA 3580A

Analytical Method: 1,8015D(M)

Extraction Date: 08/17/22 16:35

Analytical Date: 08/19/22 07:48

Cleanup Method: EPA 3630(M)

Analyst: WR

Cleanup Date: 08/18/22

Percent Solids: Results reported on an 'AS RECEIVED' basis.

Parameter	Result	Qualifier	Units	RL	MDL	Dilution Factor
<b>Total Petroleum Hydrocarbon by GC-FID - Mansfield Lab</b>						
Total Petroleum Hydrocarbons (C9-C44)	34900		mg/kg	3130	28.9	1
Surrogate			% Recovery	Qualifier	Acceptance Criteria	
d50-Tetracosane			96		50-130	

**Project Name:** HAWAII DOH - FINGERPRINTING  
**Project Number:** Not Specified

**Lab Number:** L2240634  
**Report Date:** 09/08/22

**SAMPLE RESULTS**

Lab ID: L2240634-03  
 Client ID: GASOLINE 87 F2  
 Sample Location: Not Specified

Date Collected: 07/26/22 00:00  
 Date Received: 07/29/22  
 Field Prep: Not Specified

Sample Depth:

Matrix: Oil  
 Analytical Method: 1,8015D(M)  
 Analytical Date: 08/25/22 19:02  
 Analyst: WR  
 Percent Solids: Results reported on an 'AS RECEIVED' basis.

Extraction Method: EPA 3580A  
 Extraction Date: 08/17/22 16:35  
 Cleanup Method: EPA 3630(M)  
 Cleanup Date: 08/18/22

Parameter	Result	Qualifier	Units	RL	MDL	Dilution Factor
<b>Total Petroleum Hydrocarbon by GC-FID - Mansfield Lab</b>						
Total Petroleum Hydrocarbons (C9-C44)	76100		mg/kg	3130	28.9	1
Surrogate			% Recovery	Qualifier	Acceptance Criteria	
o-Terphenyl			92		50-130	

**Project Name:** HAWAII DOH - FINGERPRINTING  
**Project Number:** Not Specified

**Lab Number:** L2240634  
**Report Date:** 09/08/22

**SAMPLE RESULTS**

Lab ID: L2240634-04  
 Client ID: GASOLINE 91  
 Sample Location: Not Specified

Date Collected: 07/26/22 00:00  
 Date Received: 07/29/22  
 Field Prep: Not Specified

Sample Depth:

Matrix: Oil  
 Analytical Method: 1,8015D(M)  
 Analytical Date: 08/18/22 04:40  
 Analyst: WR  
 Percent Solids: Results reported on an 'AS RECEIVED' basis.

Extraction Method: EPA 3580A  
 Extraction Date: 08/17/22 10:45

Parameter	Result	Qualifier	Units	RL	MDL	Dilution Factor
<b>Total Petroleum Hydrocarbon by GC-FID - Mansfield Lab</b>						
Total Petroleum Hydrocarbons (C9-C44)	142000		mg/kg	6430	59.4	1

Surrogate	% Recovery	Qualifier	Acceptance Criteria
o-Terphenyl	102		50-130
d50-Tetracosane	100		50-130

**Project Name:** HAWAII DOH - FINGERPRINTING**Lab Number:** L2240634**Project Number:** Not Specified**Report Date:** 09/08/22**SAMPLE RESULTS**

Lab ID: L2240634-05

Date Collected: 07/26/22 00:00

Client ID: GASOLINE 91 F1

Date Received: 07/29/22

Sample Location: Not Specified

Field Prep: Not Specified

Sample Depth:

Matrix: Oil

Extraction Method: EPA 3580A

Analytical Method: 1,8015D(M)

Extraction Date: 08/17/22 16:35

Analytical Date: 08/19/22 10:49

Cleanup Method: EPA 3630(M)

Analyst: WR

Cleanup Date: 08/18/22

Percent Solids: Results reported on an 'AS RECEIVED' basis.

Parameter	Result	Qualifier	Units	RL	MDL	Dilution Factor
<b>Total Petroleum Hydrocarbon by GC-FID - Mansfield Lab</b>						
Total Petroleum Hydrocarbons (C9-C44)	33800		mg/kg	3210	29.7	1
Surrogate			% Recovery	Qualifier	Acceptance Criteria	
d50-Tetracosane			93		50-130	



**Project Name:** HAWAII DOH - FINGERPRINTING**Lab Number:** L2240634**Project Number:** Not Specified**Report Date:** 09/08/22**SAMPLE RESULTS**

Lab ID: L2240634-06

Date Collected: 07/26/22 00:00

Client ID: GASOLINE 91 F2

Date Received: 07/29/22

Sample Location: Not Specified

Field Prep: Not Specified

Sample Depth:

Matrix: Oil

Extraction Method: EPA 3580A

Analytical Method: 1,8015D(M)

Extraction Date: 08/17/22 16:35

Analytical Date: 08/25/22 22:03

Cleanup Method: EPA 3630(M)

Analyst: WR

Cleanup Date: 08/18/22

Percent Solids: Results reported on an 'AS RECEIVED' basis.

Parameter	Result	Qualifier	Units	RL	MDL	Dilution Factor
Total Petroleum Hydrocarbon by GC-FID - Mansfield Lab						
Total Petroleum Hydrocarbons (C9-C44)	63500	B	mg/kg	3210	29.7	1

Surrogate	% Recovery	Qualifier	Acceptance Criteria
o-Terphenyl	89		50-130

**Project Name:** HAWAII DOH - FINGERPRINTING  
**Project Number:** Not Specified

**Lab Number:** L2240634  
**Report Date:** 09/08/22

**SAMPLE RESULTS**

Lab ID: L2240634-07  
 Client ID: GASOLINE 93  
 Sample Location: Not Specified

Date Collected: 07/26/22 00:00  
 Date Received: 07/29/22  
 Field Prep: Not Specified

Sample Depth:

Matrix: Oil  
 Analytical Method: 1,8015D(M)  
 Analytical Date: 08/18/22 06:10  
 Analyst: WR  
 Percent Solids: Results reported on an 'AS RECEIVED' basis.

Extraction Method: EPA 3580A  
 Extraction Date: 08/17/22 10:45

Parameter	Result	Qualifier	Units	RL	MDL	Dilution Factor
<b>Total Petroleum Hydrocarbon by GC-FID - Mansfield Lab</b>						
Total Petroleum Hydrocarbons (C9-C44)	144000		mg/kg	5870	54.2	1

Surrogate	% Recovery	Qualifier	Acceptance Criteria
o-Terphenyl	103		50-130
d50-Tetracosane	101		50-130

**Project Name:** HAWAII DOH - FINGERPRINTING**Lab Number:** L2240634**Project Number:** Not Specified**Report Date:** 09/08/22**SAMPLE RESULTS**

Lab ID: L2240634-08

Date Collected: 07/26/22 00:00

Client ID: GASOLINE 93 F1

Date Received: 07/29/22

Sample Location: Not Specified

Field Prep: Not Specified

Sample Depth:

Matrix: Oil

Extraction Method: EPA 3580A

Analytical Method: 1,8015D(M)

Extraction Date: 08/17/22 16:35

Analytical Date: 08/19/22 12:21

Cleanup Method: EPA 3630(M)

Analyst: WR

Cleanup Date: 08/18/22

Percent Solids: Results reported on an 'AS RECEIVED' basis.

Parameter	Result	Qualifier	Units	RL	MDL	Dilution Factor
<b>Total Petroleum Hydrocarbon by GC-FID - Mansfield Lab</b>						
Total Petroleum Hydrocarbons (C9-C44)	29100		mg/kg	2930	27.1	1
Surrogate			% Recovery	Qualifier	Acceptance Criteria	
d50-Tetracosane			96		50-130	

**Project Name:** HAWAII DOH - FINGERPRINTING**Lab Number:** L2240634**Project Number:** Not Specified**Report Date:** 09/08/22**SAMPLE RESULTS**

Lab ID: L2240634-09

Date Collected: 07/26/22 00:00

Client ID: GASOLINE 93 F2

Date Received: 07/29/22

Sample Location: Not Specified

Field Prep: Not Specified

Sample Depth:

Matrix: Oil

Extraction Method: EPA 3580A

Analytical Method: 1,8015D(M)

Extraction Date: 08/17/22 16:35

Analytical Date: 08/25/22 23:34

Cleanup Method: EPA 3630(M)

Analyst: WR

Cleanup Date: 08/18/22

Percent Solids: Results reported on an 'AS RECEIVED' basis.

Parameter	Result	Qualifier	Units	RL	MDL	Dilution Factor
<b>Total Petroleum Hydrocarbon by GC-FID - Mansfield Lab</b>						
Total Petroleum Hydrocarbons (C9-C44)	67400		mg/kg	2930	27.1	1
Surrogate			% Recovery	Qualifier	Acceptance Criteria	
o-Terphenyl			91		50-130	

**Project Name:** HAWAII DOH - FINGERPRINTING**Lab Number:** L2240634**Project Number:** Not Specified**Report Date:** 09/08/22**SAMPLE RESULTS**

Lab ID: L2240634-10

Date Collected: 07/26/22 00:00

Client ID: HEATING FUEL

Date Received: 07/29/22

Sample Location: Not Specified

Field Prep: Not Specified

Sample Depth:

Matrix: Oil

Extraction Method: EPA 3580A

Analytical Method: 1,8015D(M)

Extraction Date: 08/17/22 10:45

Analytical Date: 08/18/22 07:40

Analyst: WR

Percent Solids: Results reported on an 'AS RECEIVED' basis.

Parameter	Result	Qualifier	Units	RL	MDL	Dilution Factor
Total Petroleum Hydrocarbon by GC-FID - Mansfield Lab						
Total Petroleum Hydrocarbons (C9-C44)	884000		mg/kg	5880	54.3	1

Surrogate	% Recovery	Qualifier	Acceptance Criteria
o-Terphenyl	103		50-130
d50-Tetracosane	101		50-130

**Project Name:** HAWAII DOH - FINGERPRINTING**Lab Number:** L2240634**Project Number:** Not Specified**Report Date:** 09/08/22**SAMPLE RESULTS**

Lab ID: L2240634-11  
 Client ID: HEATING FUEL F1  
 Sample Location: Not Specified

Date Collected: 07/26/22 00:00  
 Date Received: 07/29/22  
 Field Prep: Not Specified

Sample Depth:

Matrix: Oil  
 Analytical Method: 1,8015D(M)  
 Analytical Date: 08/19/22 13:52  
 Analyst: WR  
 Percent Solids: Results reported on an 'AS RECEIVED' basis.

Extraction Method: EPA 3580A  
 Extraction Date: 08/17/22 16:35  
 Cleanup Method: EPA 3630(M)  
 Cleanup Date: 08/18/22

Parameter	Result	Qualifier	Units	RL	MDL	Dilution Factor
<b>Total Petroleum Hydrocarbon by GC-FID - Mansfield Lab</b>						
Total Petroleum Hydrocarbons (C9-C44)	511000		mg/kg	2940	27.2	1
Surrogate			% Recovery	Qualifier	Acceptance Criteria	
d50-Tetracosane			98		50-130	

**Project Name:** HAWAII DOH - FINGERPRINTING**Lab Number:** L2240634**Project Number:** Not Specified**Report Date:** 09/08/22**SAMPLE RESULTS**

Lab ID: L2240634-12

Date Collected: 07/26/22 00:00

Client ID: HEATING FUEL F2

Date Received: 07/29/22

Sample Location: Not Specified

Field Prep: Not Specified

Sample Depth:

Matrix: Oil

Extraction Method: EPA 3580A

Analytical Method: 1,8015D(M)

Extraction Date: 08/17/22 16:35

Analytical Date: 08/26/22 01:04

Cleanup Method: EPA 3630(M)

Analyst: WR

Cleanup Date: 08/18/22

Percent Solids: Results reported on an 'AS RECEIVED' basis.

Parameter	Result	Qualifier	Units	RL	MDL	Dilution Factor
<b>Total Petroleum Hydrocarbon by GC-FID - Mansfield Lab</b>						
Total Petroleum Hydrocarbons (C9-C44)	242000		mg/kg	2940	27.2	1
Surrogate			% Recovery	Qualifier	Acceptance Criteria	
o-Terphenyl			95		50-130	

**Project Name:** HAWAII DOH - FINGERPRINTING  
**Project Number:** Not Specified

**Lab Number:** L2240634  
**Report Date:** 09/08/22

**SAMPLE RESULTS**

Lab ID: L2240634-13  
 Client ID: ROAD DIESEL  
 Sample Location: Not Specified

Date Collected: 07/26/22 00:00  
 Date Received: 07/29/22  
 Field Prep: Not Specified

Sample Depth:

Matrix: Oil  
 Analytical Method: 1,8015D(M)  
 Analytical Date: 08/18/22 09:10  
 Analyst: WR  
 Percent Solids: Results reported on an 'AS RECEIVED' basis.

Extraction Method: EPA 3580A  
 Extraction Date: 08/17/22 10:45

Parameter	Result	Qualifier	Units	RL	MDL	Dilution Factor
<b>Total Petroleum Hydrocarbon by GC-FID - Mansfield Lab</b>						
Total Petroleum Hydrocarbons (C9-C44)	927000		mg/kg	5900	54.5	1

Surrogate	% Recovery	Qualifier	Acceptance Criteria
o-Terphenyl	102		50-130
d50-Tetracosane	100		50-130



**Project Name:** HAWAII DOH - FINGERPRINTING  
**Project Number:** Not Specified

**Lab Number:** L2240634  
**Report Date:** 09/08/22

**SAMPLE RESULTS**

Lab ID: L2240634-14  
 Client ID: ROAD DIESEL F1  
 Sample Location: Not Specified

Date Collected: 07/26/22 00:00  
 Date Received: 07/29/22  
 Field Prep: Not Specified

Sample Depth:

Matrix: Oil  
 Analytical Method: 1,8015D(M)  
 Analytical Date: 08/19/22 15:24  
 Analyst: WR  
 Percent Solids: Results reported on an 'AS RECEIVED' basis.

Extraction Method: EPA 3580A  
 Extraction Date: 08/17/22 16:35  
 Cleanup Method: EPA 3630(M)  
 Cleanup Date: 08/18/22

Parameter	Result	Qualifier	Units	RL	MDL	Dilution Factor
<b>Total Petroleum Hydrocarbon by GC-FID - Mansfield Lab</b>						
Total Petroleum Hydrocarbons (C9-C44)	524000		mg/kg	2950	27.3	1
Surrogate			% Recovery	Qualifier	Acceptance Criteria	
d50-Tetracosane			93		50-130	

**Project Name:** HAWAII DOH - FINGERPRINTING**Lab Number:** L2240634**Project Number:** Not Specified**Report Date:** 09/08/22**SAMPLE RESULTS**

Lab ID: L2240634-15

Date Collected: 07/26/22 00:00

Client ID: ROAD DIESEL F2

Date Received: 07/29/22

Sample Location: Not Specified

Field Prep: Not Specified

Sample Depth:

Matrix: Oil

Extraction Method: EPA 3580A

Analytical Method: 1,8015D(M)

Extraction Date: 08/17/22 16:35

Analytical Date: 08/26/22 02:34

Cleanup Method: EPA 3630(M)

Analyst: WR

Cleanup Date: 08/18/22

Percent Solids: Results reported on an 'AS RECEIVED' basis.

Parameter	Result	Qualifier	Units	RL	MDL	Dilution Factor
Total Petroleum Hydrocarbon by GC-FID - Mansfield Lab						
Total Petroleum Hydrocarbons (C9-C44)	260000		mg/kg	2950	27.3	1
Surrogate			% Recovery	Qualifier	Acceptance Criteria	
o-Terphenyl			84		50-130	

**Project Name:** HAWAII DOH - FINGERPRINTING  
**Project Number:** Not Specified

**Lab Number:** L2240634  
**Report Date:** 09/08/22

**SAMPLE RESULTS**

Lab ID: L2240634-16  
 Client ID: JP-5  
 Sample Location: Not Specified

Date Collected: 07/26/22 00:00  
 Date Received: 07/29/22  
 Field Prep: Not Specified

Sample Depth:

Matrix: Oil  
 Analytical Method: 1,8015D(M)  
 Analytical Date: 08/18/22 10:41  
 Analyst: WR  
 Percent Solids: Results reported on an 'AS RECEIVED' basis.

Extraction Method: EPA 3580A  
 Extraction Date: 08/17/22 10:45

Parameter	Result	Qualifier	Units	RL	MDL	Dilution Factor
<b>Total Petroleum Hydrocarbon by GC-FID - Mansfield Lab</b>						
Total Petroleum Hydrocarbons (C9-C44)	1010000		mg/kg	6600	61.0	1

Surrogate	% Recovery	Qualifier	Acceptance Criteria
o-Terphenyl	102		50-130
d50-Tetracosane	102		50-130

**Project Name:** HAWAII DOH - FINGERPRINTING**Lab Number:** L2240634**Project Number:** Not Specified**Report Date:** 09/08/22**SAMPLE RESULTS**

Lab ID: L2240634-17

Date Collected: 07/26/22 00:00

Client ID: JP-5 F1

Date Received: 07/29/22

Sample Location: Not Specified

Field Prep: Not Specified

Sample Depth:

Matrix: Oil

Extraction Method: EPA 3580A

Analytical Method: 1,8015D(M)

Extraction Date: 08/17/22 16:35

Analytical Date: 08/19/22 21:29

Cleanup Method: EPA 3630(M)

Analyst: WR

Cleanup Date: 08/18/22

Percent Solids: Results reported on an 'AS RECEIVED' basis.

Parameter	Result	Qualifier	Units	RL	MDL	Dilution Factor
<b>Total Petroleum Hydrocarbon by GC-FID - Mansfield Lab</b>						
Total Petroleum Hydrocarbons (C9-C44)	656000		mg/kg	1650	15.2	1
Surrogate			% Recovery	Qualifier	Acceptance Criteria	
d50-Tetracosane			94		50-130	

**Project Name:** HAWAII DOH - FINGERPRINTING**Lab Number:** L2240634**Project Number:** Not Specified**Report Date:** 09/08/22**SAMPLE RESULTS**

Lab ID: L2240634-18

Date Collected: 07/26/22 00:00

Client ID: JP-5 F2

Date Received: 07/29/22

Sample Location: Not Specified

Field Prep: Not Specified

Sample Depth:

Matrix: Oil

Extraction Method: EPA 3580A

Analytical Method: 1,8015D(M)

Extraction Date: 08/17/22 16:35

Analytical Date: 08/26/22 04:05

Cleanup Method: EPA 3630(M)

Analyst: WR

Cleanup Date: 08/18/22

Percent Solids: Results reported on an 'AS RECEIVED' basis.

Parameter	Result	Qualifier	Units	RL	MDL	Dilution Factor
<b>Total Petroleum Hydrocarbon by GC-FID - Mansfield Lab</b>						
Total Petroleum Hydrocarbons (C9-C44)	153000		mg/kg	1650	15.2	1
Surrogate			% Recovery	Qualifier	Acceptance Criteria	
o-Terphenyl			113		50-130	

**Project Name:** HAWAII DOH - FINGERPRINTING  
**Project Number:** Not Specified

**Lab Number:** L2240634  
**Report Date:** 09/08/22

**SAMPLE RESULTS**

Lab ID: L2240634-19  
 Client ID: JP-8  
 Sample Location: Not Specified

Date Collected: 07/26/22 00:00  
 Date Received: 07/29/22  
 Field Prep: Not Specified

Sample Depth:

Matrix: Oil  
 Analytical Method: 1,8015D(M)  
 Analytical Date: 08/18/22 16:46  
 Analyst: WR  
 Percent Solids: Results reported on an 'AS RECEIVED' basis.

Extraction Method: EPA 3580A  
 Extraction Date: 08/17/22 10:45

Parameter	Result	Qualifier	Units	RL	MDL	Dilution Factor
<b>Total Petroleum Hydrocarbon by GC-FID - Mansfield Lab</b>						
Total Petroleum Hydrocarbons (C9-C44)	914000		mg/kg	6600	61.0	1

Surrogate	% Recovery	Qualifier	Acceptance Criteria
o-Terphenyl	102		50-130
d50-Tetracosane	100		50-130

**Project Name:** HAWAII DOH - FINGERPRINTING**Lab Number:** L2240634**Project Number:** Not Specified**Report Date:** 09/08/22**SAMPLE RESULTS**

Lab ID: L2240634-20

Date Collected: 07/26/22 00:00

Client ID: JP-8 F1

Date Received: 07/29/22

Sample Location: Not Specified

Field Prep: Not Specified

Sample Depth:

Matrix: Oil

Extraction Method: EPA 3580A

Analytical Method: 1,8015D(M)

Extraction Date: 08/17/22 16:35

Analytical Date: 08/19/22 23:00

Cleanup Method: EPA 3630(M)

Analyst: WR

Cleanup Date: 08/18/22

Percent Solids: Results reported on an 'AS RECEIVED' basis.

Parameter	Result	Qualifier	Units	RL	MDL	Dilution Factor
<b>Total Petroleum Hydrocarbon by GC-FID - Mansfield Lab</b>						
Total Petroleum Hydrocarbons (C9-C44)	558000		mg/kg	1650	15.2	1
Surrogate			% Recovery	Qualifier	Acceptance Criteria	
d50-Tetracosane			96		50-130	

**Project Name:** HAWAII DOH - FINGERPRINTING**Lab Number:** L2240634**Project Number:** Not Specified**Report Date:** 09/08/22**SAMPLE RESULTS**

Lab ID: L2240634-21

Date Collected: 07/26/22 00:00

Client ID: JP-8 F2

Date Received: 07/29/22

Sample Location: Not Specified

Field Prep: Not Specified

Sample Depth:

Matrix: Oil

Extraction Method: EPA 3580A

Analytical Method: 1,8015D(M)

Extraction Date: 08/17/22 16:35

Analytical Date: 08/26/22 05:35

Cleanup Method: EPA 3630(M)

Analyst: WR

Cleanup Date: 08/18/22

Percent Solids: Results reported on an 'AS RECEIVED' basis.

Parameter	Result	Qualifier	Units	RL	MDL	Dilution Factor
<b>Total Petroleum Hydrocarbon by GC-FID - Mansfield Lab</b>						
Total Petroleum Hydrocarbons (C9-C44)	138000		mg/kg	1650	15.2	1
Surrogate			% Recovery	Qualifier	Acceptance Criteria	
o-Terphenyl			90		50-130	



**Project Name:** HAWAII DOH - FINGERPRINTING  
**Project Number:** Not Specified

**Lab Number:** L2240634  
**Report Date:** 09/08/22

**SAMPLE RESULTS**

Lab ID: L2240634-25  
 Client ID: BUNKER C  
 Sample Location: Not Specified

Date Collected: 07/26/22 00:00  
 Date Received: 07/29/22  
 Field Prep: Not Specified

Sample Depth:

Matrix: Oil  
 Analytical Method: 1,8015D(M)  
 Analytical Date: 08/18/22 19:48  
 Analyst: WR  
 Percent Solids: Results reported on an 'AS RECEIVED' basis.

Extraction Method: EPA 3580A  
 Extraction Date: 08/17/22 10:45

Parameter	Result	Qualifier	Units	RL	MDL	Dilution Factor
-----------	--------	-----------	-------	----	-----	-----------------

Total Petroleum Hydrocarbon by GC-FID - Mansfield Lab						
---	--	--	--	--	--	--

Total Petroleum Hydrocarbons (C9-C44)	1270000		mg/kg	12800	118.	1
---------------------------------------	---------	--	-------	-------	------	---

Surrogate	% Recovery	Qualifier	Acceptance Criteria
o-Terphenyl	101		50-130
d50-Tetracosane	103		50-130

**Project Name:** HAWAII DOH - FINGERPRINTING**Lab Number:** L2240634**Project Number:** Not Specified**Report Date:** 09/08/22**SAMPLE RESULTS**

Lab ID: L2240634-26

Date Collected: 07/26/22 00:00

Client ID: BUNKER C F1

Date Received: 07/29/22

Sample Location: Not Specified

Field Prep: Not Specified

Sample Depth:

Matrix: Oil

Extraction Method: EPA 3580A

Analytical Method: 1,8015D(M)

Extraction Date: 08/17/22 16:35

Analytical Date: 08/20/22 02:01

Cleanup Method: EPA 3630(M)

Analyst: WR

Cleanup Date: 08/18/22

Percent Solids: Results reported on an 'AS RECEIVED' basis.

Parameter	Result	Qualifier	Units	RL	MDL	Dilution Factor
Total Petroleum Hydrocarbon by GC-FID - Mansfield Lab						
Total Petroleum Hydrocarbons (C9-C44)	385000		mg/kg	3190	29.4	1
Surrogate			% Recovery	Qualifier	Acceptance Criteria	
d50-Tetracosane			95		50-130	

**Project Name:** HAWAII DOH - FINGERPRINTING**Lab Number:** L2240634**Project Number:** Not Specified**Report Date:** 09/08/22**SAMPLE RESULTS**

Lab ID: L2240634-27

Date Collected: 07/26/22 00:00

Client ID: BUNKER C F2

Date Received: 07/29/22

Sample Location: Not Specified

Field Prep: Not Specified

Sample Depth:

Matrix: Oil

Extraction Method: EPA 3580A

Analytical Method: 1,8015D(M)

Extraction Date: 08/17/22 16:35

Analytical Date: 08/26/22 07:05

Cleanup Method: EPA 3630(M)

Analyst: WR

Cleanup Date: 08/18/22

Percent Solids: Results reported on an 'AS RECEIVED' basis.

Parameter	Result	Qualifier	Units	RL	MDL	Dilution Factor
<b>Total Petroleum Hydrocarbon by GC-FID - Mansfield Lab</b>						
Total Petroleum Hydrocarbons (C9-C44)	178000		mg/kg	3190	29.4	1
Surrogate			% Recovery	Qualifier	Acceptance Criteria	
o-Terphenyl			89		50-130	

**Project Name:** HAWAII DOH - FINGERPRINTING**Lab Number:** L2240634**Project Number:** Not Specified**Report Date:** 09/08/22**SAMPLE RESULTS**

Lab ID: L2240634-32

Date Collected: 07/26/22 00:00

Client ID: WASTE OIL (AUTO)

Date Received: 07/29/22

Sample Location: Not Specified

Field Prep: Not Specified

Sample Depth:

Matrix: Oil

Extraction Method: EPA 3580A

Analytical Method: 1,8015D(M)

Extraction Date: 09/02/22 12:12

Analytical Date: 09/07/22 16:05

Analyst: WR

Percent Solids: Results reported on an 'AS RECEIVED' basis.

Parameter	Result	Qualifier	Units	RL	MDL	Dilution Factor
<b>Total Petroleum Hydrocarbon by GC-FID - Mansfield Lab</b>						
Total Petroleum Hydrocarbons (C9-C44)	809000		mg/kg	5900	54.5	1

Surrogate	% Recovery	Qualifier	Acceptance Criteria
o-Terphenyl	90		50-130
d50-Tetracosane	93		50-130

**Project Name:** HAWAII DOH - FINGERPRINTING**Lab Number:** L2240634**Project Number:** Not Specified**Report Date:** 09/08/22**SAMPLE RESULTS**

Lab ID: L2240634-33

Date Collected: 07/26/22 00:00

Client ID: WASTE OIL (AUTO) F1

Date Received: 07/29/22

Sample Location: Not Specified

Field Prep: Not Specified

Sample Depth:

Matrix: Oil

Extraction Method: EPA 3580A

Analytical Method: 1,8015D(M)

Extraction Date: 09/02/22 15:30

Analytical Date: 09/07/22 22:05

Cleanup Method: EPA 3630(M)

Analyst: WR

Cleanup Date: 09/02/22

Percent Solids: Results reported on an 'AS RECEIVED' basis.

Parameter	Result	Qualifier	Units	RL	MDL	Dilution Factor
<b>Total Petroleum Hydrocarbon by GC-FID - Mansfield Lab</b>						
Total Petroleum Hydrocarbons (C9-C44)	834000		mg/kg	2950	27.2	1
Surrogate			% Recovery	Qualifier	Acceptance Criteria	
d50-Tetracosane			109		50-130	

**Project Name:** HAWAII DOH - FINGERPRINTING**Lab Number:** L2240634**Project Number:** Not Specified**Report Date:** 09/08/22**SAMPLE RESULTS**

Lab ID: L2240634-34

Date Collected: 07/26/22 00:00

Client ID: WASTE OIL (AUTO) F2

Date Received: 07/29/22

Sample Location: Not Specified

Field Prep: Not Specified

Sample Depth:

Matrix: Oil

Extraction Method: EPA 3580A

Analytical Method: 1,8015D(M)

Extraction Date: 09/02/22 15:30

Analytical Date: 09/07/22 19:05

Cleanup Method: EPA 3630(M)

Analyst: WR

Cleanup Date: 09/02/22

Percent Solids: Results reported on an 'AS RECEIVED' basis.

Parameter	Result	Qualifier	Units	RL	MDL	Dilution Factor
<b>Total Petroleum Hydrocarbon by GC-FID - Mansfield Lab</b>						
Total Petroleum Hydrocarbons (C9-C44)	93600		mg/kg	2950	27.2	1
Surrogate			% Recovery	Qualifier	Acceptance Criteria	
o-Terphenyl			104		50-130	

**Project Name:** HAWAII DOH - FINGERPRINTING  
**Project Number:** Not Specified

**Lab Number:** L2240634  
**Report Date:** 09/08/22

**Method Blank Analysis**  
**Batch Quality Control**

Analytical Method: 1,8015D(M)  
Analytical Date: 08/17/22 19:40  
Analyst: WR

Extraction Method: EPA 3580A  
Extraction Date: 08/17/22 10:45

Parameter	Result	Qualifier	Units	RL	MDL
Total Petroleum Hydrocarbon by GC-FID - Mansfield Lab for sample(s): 01,04,07,10,13,16,19,25 Batch: WG1676301-1					
Total Petroleum Hydrocarbons (C9-C44)	ND		mg/kg	7530	69.5

Surrogate	%Recovery	Qualifier	Acceptance Criteria
o-Terphenyl	102		50-130
d50-Tetracosane	100		50-130

**Project Name:** HAWAII DOH - FINGERPRINTING  
**Project Number:** Not Specified

**Lab Number:** L2240634  
**Report Date:** 09/08/22

**Method Blank Analysis**  
**Batch Quality Control**

Analytical Method: 1,8015D(M)  
Analytical Date: 08/19/22 01:49  
Analyst: WR

Extraction Method: EPA 3580A  
Extraction Date: 08/17/22 16:35  
Cleanup Method: EPA 3630(M)  
Cleanup Date: 08/18/22

Parameter	Result	Qualifier	Units	RL	MDL
Total Petroleum Hydrocarbon by GC-FID - Mansfield Lab for sample(s): 02,05,08,11,14,17,20,26 Batch: WG1676456-1					
Total Petroleum Hydrocarbons (C9-C44)	2110	J	mg/kg	3760	34.8

Surrogate	%Recovery	Qualifier	Acceptance Criteria
d50-Tetracosane	98		50-130



**Project Name:** HAWAII DOH - FINGERPRINTING  
**Project Number:** Not Specified

**Lab Number:** L2240634  
**Report Date:** 09/08/22

**Method Blank Analysis**  
**Batch Quality Control**

Analytical Method: 1,8015D(M)  
Analytical Date: 08/25/22 09:53  
Analyst: WR

Extraction Method: EPA 3580A  
Extraction Date: 08/17/22 16:35  
Cleanup Method: EPA 3630(M)  
Cleanup Date: 08/18/22

Parameter	Result	Qualifier	Units	RL	MDL
Total Petroleum Hydrocarbon by GC-FID - Mansfield Lab for sample(s): 03,06,09,12,15,18,21,27 Batch: WG1676458-1					
Total Petroleum Hydrocarbons (C9-C44)	6380		mg/kg	3760	34.8

Surrogate	%Recovery	Qualifier	Acceptance Criteria
o-Terphenyl	93		50-130

**Project Name:** HAWAII DOH - FINGERPRINTING  
**Project Number:** Not Specified

**Lab Number:** L2240634  
**Report Date:** 09/08/22

**Method Blank Analysis**  
**Batch Quality Control**

Analytical Method: 1,8015D(M)  
Analytical Date: 09/06/22 22:04  
Analyst: WR

Extraction Method: EPA 3580A  
Extraction Date: 09/02/22 12:12

Parameter	Result	Qualifier	Units	RL	MDL
Total Petroleum Hydrocarbon by GC-FID - Mansfield Lab for sample(s): 32 Batch: WG1682983-1					
Total Petroleum Hydrocarbons (C9-C44)	ND		mg/kg	5900	54.5

Surrogate	%Recovery	Qualifier	Acceptance Criteria
o-Terphenyl	89		50-130
d50-Tetracosane	91		50-130

**Project Name:** HAWAII DOH - FINGERPRINTING  
**Project Number:** Not Specified

**Lab Number:** L2240634  
**Report Date:** 09/08/22

**Method Blank Analysis**  
**Batch Quality Control**

Analytical Method: 1,8015D(M)  
Analytical Date: 09/07/22 01:04  
Analyst: WR

Extraction Method: EPA 3580A  
Extraction Date: 09/02/22 15:30  
Cleanup Method: EPA 3630(M)  
Cleanup Date: 09/02/22

Parameter	Result	Qualifier	Units	RL	MDL
Total Petroleum Hydrocarbon by GC-FID - Mansfield Lab for sample(s): 33 Batch: WG1682989-1					
Total Petroleum Hydrocarbons (C9-C44)	ND		mg/kg	2950	27.2

Surrogate	%Recovery	Qualifier	Acceptance Criteria
d50-Tetracosane	105		50-130

**Project Name:** HAWAII DOH - FINGERPRINTING  
**Project Number:** Not Specified

**Lab Number:** L2240634  
**Report Date:** 09/08/22

**Method Blank Analysis**  
**Batch Quality Control**

Analytical Method: 1,8015D(M)  
Analytical Date: 09/06/22 23:34  
Analyst: WR

Extraction Method: EPA 3580A  
Extraction Date: 09/02/22 15:30  
Cleanup Method: EPA 3630(M)  
Cleanup Date: 09/02/22

Parameter	Result	Qualifier	Units	RL	MDL
Total Petroleum Hydrocarbon by GC-FID - Mansfield Lab for sample(s): 34 Batch: WG1682993-1					
Total Petroleum Hydrocarbons (C9-C44)	ND		mg/kg	2950	27.2

Surrogate	%Recovery	Qualifier	Acceptance Criteria
o-Terphenyl	91		50-130

## Lab Control Sample Analysis Batch Quality Control

**Project Name:** HAWAII DOH - FINGERPRINTING  
**Project Number:** Not Specified

**Lab Number:** L2240634  
**Report Date:** 09/08/22

Parameter	LCS %Recovery	Qual	LCSD %Recovery	Qual	%Recovery Limits	RPD	Qual	RPD Limits
Total Petroleum Hydrocarbon by GC-FID - Mansfield Lab Associated sample(s): 01,04,07,10,13,16,19,25 Batch: WG1676301-2 WG1676301-3								
Nonane (C9)	97		101		50-130	4		30
Decane (C10)	95		101		50-130	6		30
Dodecane (C12)	103		105		50-130	2		30
Tetradecane (C14)	99		101		50-130	2		30
Hexadecane (C16)	106		108		50-130	2		30
Octadecane (C18)	107		109		50-130	2		30
Nonadecane (C19)	101		103		50-130	2		30
Eicosane (C20)	99		102		50-130	3		30
Docosane (C22)	100		103		50-130	3		30
Tetracosane (C24)	104		107		50-130	3		30
Hexacosane (C26)	102		105		50-130	3		30
Octacosane (C28)	101		104		50-130	3		30
Triacontane (C30)	101		104		50-130	3		30
Hexatriacontane (C36)	91		94		50-130	3		30

Surrogate	LCS %Recovery	Qual	LCSD %Recovery	Qual	Acceptance Criteria
o-Terphenyl	103		103		50-130
d50-Tetracosane	101		102		50-130



## Lab Control Sample Analysis Batch Quality Control

**Project Name:** HAWAII DOH - FINGERPRINTING  
**Project Number:** Not Specified

**Lab Number:** L2240634  
**Report Date:** 09/08/22

Parameter	LCS %Recovery	Qual	LCSD %Recovery	Qual	%Recovery Limits	RPD	Qual	RPD Limits
Total Petroleum Hydrocarbon by GC-FID - Mansfield Lab Associated sample(s): 02,05,08,11,14,17,20,26 Batch: WG1676456-2 WG1676456-3								
Nonane (C9)	75		74		50-130	1		30
Decane (C10)	72		72		50-130	0		30
Dodecane (C12)	81		82		50-130	1		30
Tetradecane (C14)	84		86		50-130	2		30
Hexadecane (C16)	93		95		50-130	2		30
Octadecane (C18)	98		101		50-130	3		30
Nonadecane (C19)	100		103		50-130	3		30
Eicosane (C20)	100		102		50-130	2		30
Docosane (C22)	99		101		50-130	2		30
Tetracosane (C24)	103		105		50-130	2		30
Hexacosane (C26)	101		103		50-130	2		30
Octacosane (C28)	100		103		50-130	3		30
Triacontane (C30)	99		102		50-130	3		30
Hexatriacontane (C36)	90		92		50-130	2		30

Surrogate	LCS %Recovery	Qual	LCSD %Recovery	Qual	Acceptance Criteria
d50-Tetracosane	97		98		50-130



## Lab Control Sample Analysis Batch Quality Control

**Project Name:** HAWAII DOH - FINGERPRINTING  
**Project Number:** Not Specified

**Lab Number:** L2240634  
**Report Date:** 09/08/22

Parameter	LCS %Recovery	Qual	LCSD %Recovery	Qual	%Recovery Limits	RPD	Qual	RPD Limits
Total Petroleum Hydrocarbon by GC-FID - Mansfield Lab Associated sample(s): 32 Batch: WG1682983-2 WG1682983-3								
Nonane (C9)	88		86		50-130	2		30
Decane (C10)	88		88		50-130	0		30
Dodecane (C12)	90		91		50-130	1		30
Tetradecane (C14)	91		91		50-130	0		30
Hexadecane (C16)	94		94		50-130	0		30
Octadecane (C18)	93		93		50-130	0		30
Nonadecane (C19)	93		93		50-130	0		30
Eicosane (C20)	91		93		50-130	2		30
Docosane (C22)	92		92		50-130	0		30
Tetracosane (C24)	95		95		50-130	0		30
Hexacosane (C26)	93		93		50-130	0		30
Octacosane (C28)	96		96		50-130	0		30
Triacontane (C30)	91		92		50-130	1		30
Hexatriacontane (C36)	82		83		50-130	1		30

Surrogate	LCS %Recovery	Qual	LCSD %Recovery	Qual	Acceptance Criteria
o-Terphenyl	89		90		50-130
d50-Tetracosane	91		92		50-130

## Lab Control Sample Analysis

### Batch Quality Control

**Project Name:** HAWAII DOH - FINGERPRINTING  
**Project Number:** Not Specified

**Lab Number:** L2240634  
**Report Date:** 09/08/22

Parameter	LCS %Recovery	Qual	LCSD %Recovery	Qual	%Recovery Limits	RPD	Qual	RPD Limits
Total Petroleum Hydrocarbon by GC-FID - Mansfield Lab Associated sample(s): 33 Batch: WG1682989-2 WG1682989-3								
Nonane (C9)	82		78		50-130	5		30
Decane (C10)	85		80		50-130	6		30
Dodecane (C12)	89		84		50-130	6		30
Tetradecane (C14)	92		87		50-130	6		30
Hexadecane (C16)	102		96		50-130	6		30
Octadecane (C18)	108		101		50-130	7		30
Nonadecane (C19)	109		102		50-130	7		30
Eicosane (C20)	108		102		50-130	6		30
Docosane (C22)	107		101		50-130	6		30
Tetracosane (C24)	110		104		50-130	6		30
Hexacosane (C26)	107		101		50-130	6		30
Octacosane (C28)	106		100		50-130	6		30
Triacosane (C30)	106		100		50-130	6		30
Hexatriacontane (C36)	97		88		50-130	10		30

Surrogate	LCS %Recovery	Qual	LCSD %Recovery	Qual	Acceptance Criteria
d50-Tetracosane	105		99		50-130





### Lab Duplicate Analysis Batch Quality Control

**Project Name:** HAWAII DOH - FINGERPRINTING  
**Project Number:** Not Specified

**Lab Number:** L2240634  
**Report Date:** 09/08/22

Parameter	Native Sample	Duplicate Sample	Units	RPD	Qual	RPD Limits
Total Petroleum Hydrocarbon by GC-FID - Mansfield Lab Associated sample(s): 01,04,07,10,13,16,19,25 QC Batch ID: WG1676301-4 QC Sample: L2240634-01 Client ID: GASOLINE 87						

Total Petroleum Hydrocarbons (C9-C44)	169000	160000	mg/kg	5		30
---------------------------------------	--------	--------	-------	---	--	----

Surrogate	%Recovery	Qualifier	%Recovery	Qualifier	Acceptance Criteria
o-Terphenyl	102		102		50-130
d50-Tetracosane	100		101		50-130

Total Petroleum Hydrocarbon by GC-FID - Mansfield Lab Associated sample(s): 02,05,08,11,14,17,20,26 QC Batch ID: WG1676456-4 QC Sample: L2240634-02 Client ID: GASOLINE 87 F1						
---	--	--	--	--	--	--

Total Petroleum Hydrocarbons (C9-C44)	34900	40100	mg/kg	14		30
---------------------------------------	-------	-------	-------	----	--	----

Surrogate	%Recovery	Qualifier	%Recovery	Qualifier	Acceptance Criteria
d50-Tetracosane	96		97		50-130

Total Petroleum Hydrocarbon by GC-FID - Mansfield Lab Associated sample(s): 03,06,09,12,15,18,21,27 QC Batch ID: WG1676458-4 QC Sample: L2240634-03 Client ID: GASOLINE 87 F2						
---	--	--	--	--	--	--

Total Petroleum Hydrocarbons (C9-C44)	76100	78200	mg/kg	3		30
---------------------------------------	-------	-------	-------	---	--	----

Surrogate	%Recovery	Qualifier	%Recovery	Qualifier	Acceptance Criteria
o-Terphenyl	92		90		50-130

### Lab Duplicate Analysis Batch Quality Control

**Project Name:** HAWAII DOH - FINGERPRINTING  
**Project Number:** Not Specified

**Lab Number:** L2240634  
**Report Date:** 09/08/22

Parameter	Native Sample	Duplicate Sample	Units	RPD	Qual	RPD Limits
Total Petroleum Hydrocarbon by GC-FID - Mansfield Lab Associated sample(s): 32 QC Batch ID: WG1682983-4 QC Sample: L2240634-32 Client ID: WASTE OIL (AUTO)						

Total Petroleum Hydrocarbons (C9-C44)	809000	813000	mg/kg	0		30
---------------------------------------	--------	--------	-------	---	--	----

Surrogate	%Recovery	Qualifier	%Recovery	Qualifier	Acceptance Criteria
o-Terphenyl	90		90		50-130
d50-Tetracosane	93		92		50-130

Total Petroleum Hydrocarbon by GC-FID - Mansfield Lab Associated sample(s): 33 QC Batch ID: WG1682989-4 QC Sample: L2240634-33 Client ID: WASTE OIL (AUTO) F1						
---	--	--	--	--	--	--

Total Petroleum Hydrocarbons (C9-C44)	834000	848000	mg/kg	2		30
---------------------------------------	--------	--------	-------	---	--	----

Surrogate	%Recovery	Qualifier	%Recovery	Qualifier	Acceptance Criteria
d50-Tetracosane	109		105		50-130

Total Petroleum Hydrocarbon by GC-FID - Mansfield Lab Associated sample(s): 34 QC Batch ID: WG1682993-4 QC Sample: L2240634-34 Client ID: WASTE OIL (AUTO) F2						
---	--	--	--	--	--	--

Total Petroleum Hydrocarbons (C9-C44)	93600	83400	mg/kg	12		30
---------------------------------------	-------	-------	-------	----	--	----

Surrogate	%Recovery	Qualifier	%Recovery	Qualifier	Acceptance Criteria
o-Terphenyl	104		102		50-130

**Project Name:** HAWAII DOH - FINGERPRINTING**Lab Number:** L2240634**Project Number:** Not Specified**Report Date:** 09/08/22**SAMPLE RESULTS**

Lab ID: L2240634-01 D

Date Collected: 07/26/22 00:00

Client ID: GASOLINE 87

Date Received: 07/29/22

Sample Location:

Field Prep: Not Specified

Sample Depth:

Matrix: Oil

Analytical Method: 131, VPH-18-2.1

Analytical Date: 09/02/22 19:24

Analyst: BAD

Percent Solids: Results are reported on an 'AS RECEIVED' basis.

Trap: EST, Carbopack B/Carboxen 1000&amp;1001

Analytical Column: Restek, RTX-502.2,  
105m, 0.53ID, 3um**Quality Control Information**

Condition of sample received:

Satisfactory

Sample Temperature upon receipt:

Received on Ice

Were samples received in methanol?

Yes (Covering the Soil)

Methanol ratio:

9.0:1

Parameter	Result	Qualifier	Units	RL	MDL	Dilution Factor
<b>Volatile Petroleum Hydrocarbons - Westborough Lab</b>						
C5-C8 Aliphatics	124000		mg/kg	22500	22500	500
C9-C12 Aliphatics	78900		mg/kg	22500	22500	500
C9-C10 Aromatics	28400		mg/kg	22500	22500	500
C5-C8 Aliphatics, Adjusted	80600		mg/kg	22500	22500	500
C9-C12 Aliphatics, Adjusted	ND		mg/kg	22500	22500	500

Surrogate	% Recovery	Qualifier	Acceptance Criteria
2,5-Dibromotoluene-PID	0	Q	70-130
2,5-Dibromotoluene-FID	0	Q	70-130

**Project Name:** HAWAII DOH - FINGERPRINTING**Lab Number:** L2240634**Project Number:** Not Specified**Report Date:** 09/08/22**SAMPLE RESULTS**

Lab ID: L2240634-04 D

Date Collected: 07/26/22 00:00

Client ID: GASOLINE 91

Date Received: 07/29/22

Sample Location:

Field Prep: Not Specified

Sample Depth:

Matrix: Oil

Analytical Method: 131, VPH-18-2.1

Analytical Date: 09/02/22 21:23

Analyst: BAD

Percent Solids: Results are reported on an 'AS RECEIVED' basis.

Trap: EST, Carbopack B/Carboxen 1000&amp;1001

Analytical Column: Restek, RTX-502.2,  
105m, 0.53ID, 3um**Quality Control Information**

Condition of sample received:

Satisfactory

Sample Temperature upon receipt:

Received on Ice

Were samples received in methanol?

Yes (Covering the Soil)

Methanol ratio:

8.8:1

Parameter	Result	Qualifier	Units	RL	MDL	Dilution Factor
<b>Volatile Petroleum Hydrocarbons - Westborough Lab</b>						
C5-C8 Aliphatics	121000		mg/kg	21900	21900	500
C9-C12 Aliphatics	72200		mg/kg	21900	21900	500
C9-C10 Aromatics	27000		mg/kg	21900	21900	500
C5-C8 Aliphatics, Adjusted	77900		mg/kg	21900	21900	500
C9-C12 Aliphatics, Adjusted	ND		mg/kg	21900	21900	500

Surrogate	% Recovery	Qualifier	Acceptance Criteria
2,5-Dibromotoluene-PID	0	Q	70-130
2,5-Dibromotoluene-FID	0	Q	70-130

**Project Name:** HAWAII DOH - FINGERPRINTING**Lab Number:** L2240634**Project Number:** Not Specified**Report Date:** 09/08/22**SAMPLE RESULTS**

Lab ID: L2240634-07 D

Date Collected: 07/26/22 00:00

Client ID: GASOLINE 93

Date Received: 07/29/22

Sample Location:

Field Prep: Not Specified

Sample Depth:

Matrix: Oil

Analytical Method: 131, VPH-18-2.1

Analytical Date: 09/02/22 22:23

Analyst: BAD

Percent Solids: Results are reported on an 'AS RECEIVED' basis.

Trap: EST, Carbopack B/Carboxen 1000&amp;1001

Analytical Column: Restek, RTX-502.2,  
105m, 0.53ID, 3um**Quality Control Information**

Condition of sample received:

Satisfactory

Sample Temperature upon receipt:

Received on Ice

Were samples received in methanol?

Yes (Covering the Soil)

Methanol ratio:

8.5:1

Parameter	Result	Qualifier	Units	RL	MDL	Dilution Factor
<b>Volatile Petroleum Hydrocarbons - Westborough Lab</b>						
C5-C8 Aliphatics	91000		mg/kg	21400	21400	500
C9-C12 Aliphatics	57400		mg/kg	21400	21400	500
C9-C10 Aromatics	ND		mg/kg	21400	21400	500
C5-C8 Aliphatics, Adjusted	53400		mg/kg	21400	21400	500
C9-C12 Aliphatics, Adjusted	30100		mg/kg	21400	21400	500

Surrogate	% Recovery	Qualifier	Acceptance Criteria
2,5-Dibromotoluene-PID	0	Q	70-130
2,5-Dibromotoluene-FID	0	Q	70-130

**Project Name:** HAWAII DOH - FINGERPRINTING**Lab Number:** L2240634**Project Number:** Not Specified**Report Date:** 09/08/22**SAMPLE RESULTS**

Lab ID: L2240634-10 D

Date Collected: 07/26/22 00:00

Client ID: HEATING FUEL

Date Received: 07/29/22

Sample Location:

Field Prep: Not Specified

Sample Depth:

Matrix: Oil

Analytical Method: 131, VPH-18-2.1

Analytical Date: 09/02/22 23:23

Analyst: BAD

Percent Solids: Results are reported on an 'AS RECEIVED' basis.

Trap: EST, Carbopack B/Carboxen 1000&amp;1001

Analytical Column: Restek, RTX-502.2,  
105m, 0.53ID, 3um**Quality Control Information**

Condition of sample received:

Satisfactory

Sample Temperature upon receipt:

Received on Ice

Were samples received in methanol?

Yes (Covering the Soil)

Methanol ratio:

8.5:1

Parameter	Result	Qualifier	Units	RL	MDL	Dilution Factor
<b>Volatile Petroleum Hydrocarbons - Westborough Lab</b>						
C5-C8 Aliphatics	ND		mg/kg	8550	8550	200
C9-C12 Aliphatics	110000		mg/kg	8550	8550	200
C9-C10 Aromatics	60200		mg/kg	8550	8550	200
C5-C8 Aliphatics, Adjusted	ND		mg/kg	8550	8550	200
C9-C12 Aliphatics, Adjusted	48300		mg/kg	8550	8550	200

Surrogate	% Recovery	Qualifier	Acceptance Criteria
2,5-Dibromotoluene-PID	0	Q	70-130
2,5-Dibromotoluene-FID	0	Q	70-130

**Project Name:** HAWAII DOH - FINGERPRINTING**Lab Number:** L2240634**Project Number:** Not Specified**Report Date:** 09/08/22**SAMPLE RESULTS**

Lab ID: L2240634-13 D

Date Collected: 07/26/22 00:00

Client ID: ROAD DIESEL

Date Received: 07/29/22

Sample Location:

Field Prep: Not Specified

Sample Depth:

Matrix: Oil

Analytical Method: 131, VPH-18-2.1

Analytical Date: 09/03/22 00:23

Analyst: BAD

Percent Solids: Results are reported on an 'AS RECEIVED' basis.

Trap: EST, Carbopack B/Carboxen 1000&amp;1001

Analytical Column: Restek, RTX-502.2,  
105m, 0.53ID, 3um**Quality Control Information**

Condition of sample received:

Satisfactory

Sample Temperature upon receipt:

Received on Ice

Were samples received in methanol?

Yes (Covering the Soil)

Methanol ratio:

6.0:1

Parameter	Result	Qualifier	Units	RL	MDL	Dilution Factor
<b>Volatile Petroleum Hydrocarbons - Westborough Lab</b>						
C5-C8 Aliphatics	ND		mg/kg	5990	5990	200
C9-C12 Aliphatics	66700		mg/kg	5990	5990	200
C9-C10 Aromatics	38200		mg/kg	5990	5990	200
C5-C8 Aliphatics, Adjusted	ND		mg/kg	5990	5990	200
C9-C12 Aliphatics, Adjusted	19600		mg/kg	5990	5990	200

Surrogate	% Recovery	Qualifier	Acceptance Criteria
2,5-Dibromotoluene-PID	0	Q	70-130
2,5-Dibromotoluene-FID	0	Q	70-130

**Project Name:** HAWAII DOH - FINGERPRINTING**Lab Number:** L2240634**Project Number:** Not Specified**Report Date:** 09/08/22**SAMPLE RESULTS**

Lab ID: L2240634-25 D

Date Collected: 07/26/22 00:00

Client ID: BUNKER C

Date Received: 07/29/22

Sample Location:

Field Prep: Not Specified

Sample Depth:

Matrix: Oil

Analytical Method: 131, VPH-18-2.1

Analytical Date: 09/03/22 01:23

Analyst: BAD

Percent Solids: Results are reported on an 'AS RECEIVED' basis.

Trap: EST, Carboxen B/Carboxen 1000&amp;1001

Analytical Column: Restek, RTX-502.2,  
105m, 0.53ID, 3um**Quality Control Information**

Condition of sample received:

Satisfactory

Sample Temperature upon receipt:

Received on Ice

Were samples received in methanol?

Yes (Covering the Soil)

Methanol ratio:

8.5:1

Parameter	Result	Qualifier	Units	RL	MDL	Dilution Factor
<b>Volatile Petroleum Hydrocarbons - Westborough Lab</b>						
C5-C8 Aliphatics	ND		mg/kg	855	855.	20
C9-C12 Aliphatics	21000		mg/kg	855	855.	20
C9-C10 Aromatics	12700		mg/kg	855	855.	20
C5-C8 Aliphatics, Adjusted	ND		mg/kg	855	855.	20
C9-C12 Aliphatics, Adjusted	8230		mg/kg	855	855.	20

Surrogate	% Recovery	Qualifier	Acceptance Criteria
2,5-Dibromotoluene-PID	0	Q	70-130
2,5-Dibromotoluene-FID	0	Q	70-130



**Project Name:** HAWAII DOH - FINGERPRINTING**Lab Number:** L2240634**Project Number:** Not Specified**Report Date:** 09/08/22**SAMPLE RESULTS**

Lab ID: L2240634-30 D  
 Client ID: JP-5 MEOH (20 MG/ML)  
 Sample Location:

Date Collected: 08/17/22 12:15  
 Date Received: 08/17/22  
 Field Prep: Not Specified

Sample Depth:  
 Matrix: Oil  
 Analytical Method: 131, VPH-18-2.1  
 Analytical Date: 09/08/22 12:54  
 Analyst: BAD  
 Percent Solids: Results are reported on an 'AS RECEIVED' basis.

**Trap:** EST, Carbopack B/Carboxen 1000&1001**Analytical Column:** Restek, RTX-502.2, 105m, 0.53ID, 3um**Quality Control Information**

Condition of sample received: Satisfactory  
 Sample Temperature upon receipt: Received on Ice  
 Were samples received in methanol? Yes (Covering the Soil)  
 Methanol ratio: 20.:1

Parameter	Result	Qualifier	Units	RL	MDL	Dilution Factor
<b>Volatile Petroleum Hydrocarbons - Westborough Lab</b>						
C5-C8 Aliphatics	340		mg/kg	196	196.	2
C9-C12 Aliphatics	11700		mg/kg	196	196.	2
C9-C10 Aromatics	5250		mg/kg	196	196.	2
C5-C8 Aliphatics, Adjusted	340		mg/kg	196	196.	2
C9-C12 Aliphatics, Adjusted	6410		mg/kg	196	196.	2

Surrogate	% Recovery	Qualifier	Acceptance Criteria
2,5-Dibromotoluene-PID	95		70-130
2,5-Dibromotoluene-FID	107		70-130

**Project Name:** HAWAII DOH - FINGERPRINTING**Lab Number:** L2240634**Project Number:** Not Specified**Report Date:** 09/08/22**SAMPLE RESULTS**

Lab ID: L2240634-31 D  
 Client ID: JP-8 MEOH (20 MG/ML)  
 Sample Location:

Date Collected: 08/17/22 12:15  
 Date Received: 08/17/22  
 Field Prep: Not Specified

Sample Depth:  
 Matrix: Oil  
 Analytical Method: 131, VPH-18-2.1  
 Analytical Date: 09/08/22 13:53  
 Analyst: BAD  
 Percent Solids: Results are reported on an 'AS RECEIVED' basis.

**Trap:** EST, Carbopack B/Carboxen 1000&1001**Analytical Column:** Restek, RTX-502.2, 105m, 0.53ID, 3um**Quality Control Information**

Condition of sample received: Satisfactory  
 Sample Temperature upon receipt: Received on Ice  
 Were samples received in methanol? Yes (Covering the Soil)  
 Methanol ratio: 20.:1

Parameter	Result	Qualifier	Units	RL	MDL	Dilution Factor
<b>Volatile Petroleum Hydrocarbons - Westborough Lab</b>						
C5-C8 Aliphatics	2590		mg/kg	200	200.	2
C9-C12 Aliphatics	10900		mg/kg	200	200.	2
C9-C10 Aromatics	4040		mg/kg	200	200.	2
C5-C8 Aliphatics, Adjusted	2560		mg/kg	200	200.	2
C9-C12 Aliphatics, Adjusted	6370		mg/kg	200	200.	2

Surrogate	% Recovery	Qualifier	Acceptance Criteria
2,5-Dibromotoluene-PID	85		70-130
2,5-Dibromotoluene-FID	74		70-130

**Project Name:** HAWAII DOH - FINGERPRINTING**Lab Number:** L2240634**Project Number:** Not Specified**Report Date:** 09/08/22**SAMPLE RESULTS**

Lab ID: L2240634-32 D  
 Client ID: WASTE OIL (AUTO)  
 Sample Location:

Date Collected: 07/26/22 00:00  
 Date Received: 07/29/22  
 Field Prep: Not Specified

Sample Depth:  
 Matrix: Oil  
 Analytical Method: 131, VPH-18-2.1  
 Analytical Date: 09/03/22 02:22  
 Analyst: BAD  
 Percent Solids: Results are reported on an 'AS RECEIVED' basis.

**Trap:** EST, Carbopack B/Carboxen 1000&1001**Analytical Column:** Restek, RTX-502.2, 105m, 0.53ID, 3um**Quality Control Information**

Condition of sample received: Satisfactory  
 Sample Temperature upon receipt: Received on Ice  
 Were samples received in methanol? Yes (Covering the Soil)  
 Methanol ratio: 9.9:1

Parameter	Result	Qualifier	Units	RL	MDL	Dilution Factor
<b>Volatile Petroleum Hydrocarbons - Westborough Lab</b>						
C5-C8 Aliphatics	1310		mg/kg	248	248.	5
C9-C12 Aliphatics	5430		mg/kg	248	248.	5
C9-C10 Aromatics	3360		mg/kg	248	248.	5
C5-C8 Aliphatics, Adjusted	1060		mg/kg	248	248.	5
C9-C12 Aliphatics, Adjusted	1240		mg/kg	248	248.	5

Surrogate	% Recovery	Qualifier	Acceptance Criteria
2,5-Dibromotoluene-PID	83		70-130
2,5-Dibromotoluene-FID	14	Q	70-130

**Project Name:** HAWAII DOH - FINGERPRINTING  
**Project Number:** Not Specified

**Lab Number:** L2240634  
**Report Date:** 09/08/22

**Method Blank Analysis**  
**Batch Quality Control**

Analytical Method: 131, VPH-18-2.1  
Analytical Date: 09/02/22 11:00  
Analyst: BAD

Parameter	Result	Qualifier	Units	RL	MDL
Volatile Petroleum Hydrocarbons - Westborough Lab for sample(s): 01,04,07,10,13,25,32 Batch: WG1684889-4					
C5-C8 Aliphatics	ND		mg/kg	50.0	50.0
C9-C12 Aliphatics	ND		mg/kg	50.0	50.0
C9-C10 Aromatics	ND		mg/kg	50.0	50.0
C5-C8 Aliphatics, Adjusted	ND		mg/kg	50.0	50.0
C9-C12 Aliphatics, Adjusted	ND		mg/kg	50.0	50.0

Surrogate	%Recovery	Qualifier	Acceptance Criteria
2,5-Dibromotoluene-PID	105		70-130
2,5-Dibromotoluene-FID	108		70-130

**Project Name:** HAWAII DOH - FINGERPRINTING**Lab Number:** L2240634**Project Number:** Not Specified**Report Date:** 09/08/22

### Method Blank Analysis Batch Quality Control

Analytical Method: 131, VPH-18-2.1

Analytical Date: 09/08/22 11:54

Analyst: BAD

Parameter	Result	Qualifier	Units	RL	MDL
Volatile Petroleum Hydrocarbons - Westborough Lab for sample(s): 30-31 Batch: WG1685081-4					
C5-C8 Aliphatics	ND		mg/kg	50.0	50.0
C9-C12 Aliphatics	ND		mg/kg	50.0	50.0
C9-C10 Aromatics	ND		mg/kg	50.0	50.0
C5-C8 Aliphatics, Adjusted	ND		mg/kg	50.0	50.0
C9-C12 Aliphatics, Adjusted	ND		mg/kg	50.0	50.0

Surrogate	%Recovery	Qualifier	Acceptance Criteria
2,5-Dibromotoluene-PID	98		70-130
2,5-Dibromotoluene-FID	106		70-130

### Lab Control Sample Analysis Batch Quality Control

**Project Name:** HAWAII DOH - FINGERPRINTING  
**Project Number:** Not Specified

**Lab Number:** L2240634  
**Report Date:** 09/08/22

Parameter	LCS		LCSD		%Recovery		RPD	Qual	RPD Limits
	%Recovery	Qual	%Recovery	Qual	Limits	RPD			
Volatile Petroleum Hydrocarbons - Westborough Lab Associated sample(s): 01,04,07,10,13,25,32 Batch: WG1684889-2 WG1684889-3									
C5-C8 Aliphatics	100		100		70-130	0			25
C9-C12 Aliphatics	114		116		70-130	2			25
C9-C10 Aromatics	106		106		70-130	0			25
Benzene	106		106		70-130	0			25
Toluene	108		108		70-130	0			25
Ethylbenzene	109		108		70-130	1			25
p/m-Xylene	109		108		70-130	1			25
o-Xylene	106		105		70-130	1			25
Methyl tert butyl ether	98		95		70-130	3			25
Naphthalene	102		98		70-130	4			25
1,2,4-Trimethylbenzene	106		106		70-130	0			25
Pentane	85		84		70-130	1			25
2-Methylpentane	100		101		70-130	1			25
2,2,4-Trimethylpentane	110		111		70-130	1			25
n-Nonane	115		117		30-130	2			25
n-Decane	113		115		70-130	2			25
n-Butylcyclohexane	114		116		70-130	2			25

Surrogate	LCS		LCSD		Acceptance Criteria
	%Recovery	Qual	%Recovery	Qual	
2,5-Dibromotoluene-PID	109		103		70-130
2,5-Dibromotoluene-FID	109		106		70-130



## Lab Control Sample Analysis Batch Quality Control

**Project Name:** HAWAII DOH - FINGERPRINTING  
**Project Number:** Not Specified

**Lab Number:** L2240634  
**Report Date:** 09/08/22

Parameter	LCS %Recovery	Qual	LCS %Recovery	Qual	%Recovery Limits	RPD	Qual	RPD Limits
Volatile Petroleum Hydrocarbons - Westborough Lab Associated sample(s): 30-31 Batch: WG1685081-2 WG1685081-3								
C5-C8 Aliphatics	94		94		70-130	0		25
C9-C12 Aliphatics	111		111		70-130	0		25
C9-C10 Aromatics	98		98		70-130	0		25
Benzene	98		97		70-130	0		25
Toluene	99		99		70-130	0		25
Ethylbenzene	100		100		70-130	0		25
p/m-Xylene	100		100		70-130	0		25
o-Xylene	98		97		70-130	0		25
Methyl tert butyl ether	88		87		70-130	1		25
Naphthalene	92		92		70-130	0		25
1,2,4-Trimethylbenzene	98		98		70-130	0		25
Pentane	80		80		70-130	0		25
2-Methylpentane	93		92		70-130	0		25
2,2,4-Trimethylpentane	105		105		70-130	0		25
n-Nonane	112		112		30-130	0		25
n-Decane	108		109		70-130	1		25
n-Butylcyclohexane	111		111		70-130	0		25

Surrogate	LCS %Recovery	Qual	LCS %Recovery	Qual	Acceptance Criteria
2,5-Dibromotoluene-PID	96		95		70-130
2,5-Dibromotoluene-FID	103		102		70-130

## Lab Duplicate Analysis

Batch Quality Control

Project Name: HAWAII DOH - FINGERPRINTING

Project Number: Not Specified

Lab Number: L2240634

Report Date: 09/08/22

Parameter	Native Sample	Duplicate Sample	Units	RPD	Qual	RPD Limits
Volatile Petroleum Hydrocarbons - Westborough Lab Associated sample(s): 01,04,07,10,13,25,32 QC Batch ID: WG1684889-6 QC Sample: L2240634-01 Client ID: GASOLINE 87						
C5-C8 Aliphatics	124000	123000	mg/kg	1		50
C9-C12 Aliphatics	78900	75700	mg/kg	4		50
C9-C10 Aromatics	28400	25900	mg/kg	9		50
C5-C8 Aliphatics, Adjusted	80600	79600	mg/kg	1		50
C9-C12 Aliphatics, Adjusted	ND	ND	mg/kg	NC		50

Surrogate	%Recovery	Qualifier	%Recovery	Qualifier	Acceptance Criteria
2,5-Dibromotoluene-PID	0	Q	0	Q	70-130
2,5-Dibromotoluene-FID	0	Q	0	Q	70-130



**Project Name:** HAWAII DOH - FINGERPRINTING**Lab Number:** L2240634**Project Number:** Not Specified**Report Date:** 09/08/22**Sample Receipt and Container Information**

Were project specific reporting limits specified?

YES

**Cooler Information**

<b>Cooler</b>	<b>Custody Seal</b>
N/A	Absent

**Container Information**

<b>Container ID</b>	<b>Container Type</b>	<b>Cooler</b>	<b>Initial pH</b>	<b>Final pH</b>	<b>Temp deg C</b>	<b>Pres</b>	<b>Seal</b>	<b>Frozen Date/Time</b>	<b>Analysis(*)</b>
L2240634-01A	Vial unpreserved 20ml hard-cap	N/A	NA			Y	Absent		A2-NFTPH(365),A2-NFPIANO8260(365)
L2240634-01B	Vial unpreserved	N/A	NA			Y	Absent		VPH-18(28)
L2240634-01W	Vial MeOH preserved split	N/A	NA			Y	Absent		VPH-18(28)
L2240634-01X	Vial unpreserved 20ml hard-cap split	N/A	NA			Y	Absent		A2-NFPIANO8260(365)
L2240634-01Y	Vial unpreserved 20ml hard-cap split	N/A	NA			Y	Absent		A2-NFPIANO8260(365)
L2240634-04A	Vial unpreserved 20ml hard-cap	N/A	NA			Y	Absent		A2-NFTPH(365),A2-NFPIANO8260(365)
L2240634-04B	Vial unpreserved	N/A	NA			Y	Absent		VPH-18(28)
L2240634-04W	Vial MeOH preserved split	N/A	NA			Y	Absent		VPH-18(28)
L2240634-04X	Vial unpreserved 20ml hard-cap split	N/A	NA			Y	Absent		A2-NFPIANO8260(365)
L2240634-04Y	Vial unpreserved 20ml hard-cap split	N/A	NA			Y	Absent		A2-NFPIANO8260(365)
L2240634-07A	Vial unpreserved 20ml hard-cap	N/A	NA			Y	Absent		A2-NFTPH(365),A2-NFPIANO8260(365)
L2240634-07B	Vial unpreserved	N/A	NA			Y	Absent		VPH-18(28)
L2240634-07W	Vial MeOH preserved split	N/A	NA			Y	Absent		VPH-18(28)
L2240634-07X	Vial unpreserved 20ml hard-cap split	N/A	NA			Y	Absent		A2-NFPIANO8260(365)
L2240634-07Y	Vial unpreserved 20ml hard-cap split	N/A	NA			Y	Absent		A2-NFPIANO8260(365)
L2240634-10A	Vial unpreserved 20ml hard-cap	N/A	NA			Y	Absent		A2-NFTPH(365),A2-NFPIANO8260(365)
L2240634-10V	Split Small Ampule	N/A	NA			Y	Absent		A2-NFTPH(365)
L2240634-10W	Vial unpreserved	N/A	NA			Y	Absent		VPH-18(28)
L2240634-10X	Vial unpreserved 20ml hard-cap split	N/A	NA			Y	Absent		A2-NFPIANO8260(365)
L2240634-10Y	Vial unpreserved 20ml hard-cap split	N/A	NA			Y	Absent		A2-NFPIANO8260(365)
L2240634-10Z	Vial MeOH preserved split	N/A	NA			Y	Absent		VPH-18(28)
L2240634-13A	Vial unpreserved 20ml hard-cap	N/A	NA			Y	Absent		A2-NFTPH(365),A2-NFPIANO8260(365)
L2240634-13B	Vial unpreserved	N/A	NA			Y	Absent		VPH-18(28)

**Project Name:** HAWAII DOH - FINGERPRINTING**Lab Number:** L2240634**Project Number:** Not Specified**Report Date:** 09/08/22**Container Information**

<b>Container ID</b>	<b>Container Type</b>	<b>Cooler</b>	<b>Initial pH</b>	<b>Final pH</b>	<b>Temp deg C</b>	<b>Pres</b>	<b>Seal</b>	<b>Frozen Date/Time</b>	<b>Analysis(*)</b>
L2240634-13W	Vial MeOH preserved split	N/A	NA			Y	Absent		VPH-18(28)
L2240634-13X	Vial unpreserved 20ml hard-cap split	N/A	NA			Y	Absent		A2-NFPIANO8260(365)
L2240634-13Y	Vial unpreserved 20ml hard-cap split	N/A	NA			Y	Absent		A2-NFPIANO8260(365)
L2240634-16A	Small Ampule	N/A	NA			Y	Absent		A2-NFTPH(365)
L2240634-16B	Small Ampule	N/A	NA			Y	Absent		A2-NFTPH(365)
L2240634-19A	Small Ampule	N/A	NA			Y	Absent		A2-NFTPH(365)
L2240634-19B	Small Ampule	N/A	NA			Y	Absent		A2-NFTPH(365)
L2240634-22A	Small Ampule	N/A	NA			Y	Absent		TS100(),HOLD-NFSHC(365)
L2240634-22W	Vial unpreserved	N/A	NA			Y	Absent		TS100(),HOLD-NFSHC(365)
L2240634-22X	Vial unpreserved 20ml hard-cap split	N/A	NA			Y	Absent		TS100(),HOLD-NFSHC(365)
L2240634-22Y	Vial unpreserved 20ml hard-cap split	N/A	NA			Y	Absent		TS100(),HOLD-NFSHC(365)
L2240634-22Z	Vial MeOH preserved split	N/A	NA			Y	Absent		TS100(),HOLD-NFSHC(365)
L2240634-25A	Vial unpreserved 20ml hard-cap	N/A	NA			Y	Absent		A2-NFTPH(365),A2-NFPIANO8260(365)
L2240634-25V	Glass 60mL/2oz unpreserved	N/A	NA			Y	Absent		A2-NFTPH(365)
L2240634-25W	Vial MeOH preserved split	N/A	NA			Y	Absent		VPH-18(28)
L2240634-25X	Vial unpreserved 20ml hard-cap split	N/A	NA			Y	Absent		A2-NFPIANO8260(365)
L2240634-25Y	Vial unpreserved 20ml hard-cap split	N/A	NA			Y	Absent		A2-NFPIANO8260(365)
L2240634-25Z	Vial unpreserved	N/A	NA			Y	Absent		VPH-18(28)
L2240634-28A	Small Ampule	N/A	NA			Y	Absent		CANCELLED()
L2240634-28B	Small Ampule	N/A	NA			Y	Absent		CANCELLED()
L2240634-29A	Small Ampule	N/A	NA			Y	Absent		CANCELLED()
L2240634-29B	Small Ampule	N/A	NA			Y	Absent		CANCELLED()
L2240634-30A	Small Ampule	N/A	NA			Y	Absent		A2-NFPIANO8260(365)
L2240634-30B	Small Ampule	N/A	NA			Y	Absent		VPH-18(28)
L2240634-30W	Vial MeOH preserved split	NA	NA			Y	Absent		VPH-18(28)
L2240634-30X	Vial unpreserved 20ml hard-cap split	N/A	NA			Y	Absent		A2-NFPIANO8260(365)
L2240634-31A	Small Ampule	N/A	NA			Y	Absent		A2-NFPIANO8260(365)
L2240634-31B	Small Ampule	N/A	NA			Y	Absent		VPH-18(28)

**Project Name:** HAWAII DOH - FINGERPRINTING**Lab Number:** L2240634**Project Number:** Not Specified**Report Date:** 09/08/22**Container Information**

<b>Container ID</b>	<b>Container Type</b>	<b>Cooler</b>	<b>Initial pH</b>	<b>Final pH</b>	<b>Temp deg C</b>	<b>Pres</b>	<b>Seal</b>	<b>Frozen Date/Time</b>	<b>Analysis(*)</b>
L2240634-31W	Vial MeOH preserved split	NA	NA			Y	Absent		VPH-18(28)
L2240634-31X	Vial unpreserved 20ml hard-cap split	N/A	NA			Y	Absent		A2-NFPIANO8260(365)
L2240634-32A	Vial unpreserved	N/A	NA			Y	Absent		A2-NFTPH(365)
L2240634-32V	Vial unpreserved split	N/A	NA			Y	Absent		A2-NFTPH(365),A2-NFPIANO8260(365)
L2240634-32W	Vial unpreserved split	N/A	NA			Y	Absent		VPH-18(28)
L2240634-32X	Vial unpreserved 20ml hard-cap split	N/A	NA			Y	Absent		A2-NFPIANO8260(365)
L2240634-32Y	Vial unpreserved 20ml hard-cap split	N/A	NA			Y	Absent		A2-NFPIANO8260(365)
L2240634-32Z	Vial MeOH preserved split	N/A	NA			Y	Absent		VPH-18(28)

**Container Comments**

L2240634-30A	Ampule placed in Glass-A.120
L2240634-30B	Ampule placed in Glass-A.120
L2240634-31A	Ampule placed in Glass-A.120
L2240634-31B	Ampule placed in Glass-A.120

**Project Name:** HAWAII DOH - FINGERPRINTING**Lab Number:** L2240634**Project Number:** Not Specified**Report Date:** 09/08/22

## GLOSSARY

### Acronyms

DL	- Detection Limit: This value represents the level to which target analyte concentrations are reported as estimated values, when those target analyte concentrations are quantified below the limit of quantitation (LOQ). The DL includes any adjustments from dilutions, concentrations or moisture content, where applicable. (DoD report formats only.)
EDL	- Estimated Detection Limit: This value represents the level to which target analyte concentrations are reported as estimated values, when those target analyte concentrations are quantified below the reporting limit (RL). The EDL includes any adjustments from dilutions, concentrations or moisture content, where applicable. The use of EDLs is specific to the analysis of PAHs using Solid-Phase Microextraction (SPME).
EMPC	- Estimated Maximum Possible Concentration: The concentration that results from the signal present at the retention time of an analyte when the ions meet all of the identification criteria except the ion abundance ratio criteria. An EMPC is a worst-case estimate of the concentration.
EPA	- Environmental Protection Agency.
LCS	- Laboratory Control Sample: A sample matrix, free from the analytes of interest, spiked with verified known amounts of analytes or a material containing known and verified amounts of analytes.
LCSD	- Laboratory Control Sample Duplicate: Refer to LCS.
LFB	- Laboratory Fortified Blank: A sample matrix, free from the analytes of interest, spiked with verified known amounts of analytes or a material containing known and verified amounts of analytes.
LOD	- Limit of Detection: This value represents the level to which a target analyte can reliably be detected for a specific analyte in a specific matrix by a specific method. The LOD includes any adjustments from dilutions, concentrations or moisture content, where applicable. (DoD report formats only.)
LOQ	- Limit of Quantitation: The value at which an instrument can accurately measure an analyte at a specific concentration. The LOQ includes any adjustments from dilutions, concentrations or moisture content, where applicable. (DoD report formats only.)  Limit of Quantitation: The value at which an instrument can accurately measure an analyte at a specific concentration. The LOQ includes any adjustments from dilutions, concentrations or moisture content, where applicable. (DoD report formats only.)
MDL	- Method Detection Limit: This value represents the level to which target analyte concentrations are reported as estimated values, when those target analyte concentrations are quantified below the reporting limit (RL). The MDL includes any adjustments from dilutions, concentrations or moisture content, where applicable.
MS	- Matrix Spike Sample: A sample prepared by adding a known mass of target analyte to a specified amount of matrix sample for which an independent estimate of target analyte concentration is available. For Method 332.0, the spike recovery is calculated using the native concentration, including estimated values.
MSD	- Matrix Spike Sample Duplicate: Refer to MS.
NA	- Not Applicable.
NC	- Not Calculated: Term is utilized when one or more of the results utilized in the calculation are non-detect at the parameter's reporting unit.
NDPA/DPA	- N-Nitrosodiphenylamine/Diphenylamine.
NI	- Not Ignitable.
NP	- Non-Plastic: Term is utilized for the analysis of Atterberg Limits in soil.
NR	- No Results: Term is utilized when 'No Target Compounds Requested' is reported for the analysis of Volatile or Semivolatile Organic TIC only requests.
RL	- Reporting Limit: The value at which an instrument can accurately measure an analyte at a specific concentration. The RL includes any adjustments from dilutions, concentrations or moisture content, where applicable.
RPD	- Relative Percent Difference: The results from matrix and/or matrix spike duplicates are primarily designed to assess the precision of analytical results in a given matrix and are expressed as relative percent difference (RPD). Values which are less than five times the reporting limit for any individual parameter are evaluated by utilizing the absolute difference between the values; although the RPD value will be provided in the report.
SRM	- Standard Reference Material: A reference sample of a known or certified value that is of the same or similar matrix as the associated field samples.
STLP	- Semi-dynamic Tank Leaching Procedure per EPA Method 1315.
TEF	- Toxic Equivalency Factors: The values assigned to each dioxin and furan to evaluate their toxicity relative to 2,3,7,8-TCDD.
TEQ	- Toxic Equivalent: The measure of a sample's toxicity derived by multiplying each dioxin and furan by its corresponding TEF and then summing the resulting values.
TIC	- Tentatively Identified Compound: A compound that has been identified to be present and is not part of the target compound list (TCL) for the method and/or program. All TICs are qualitatively identified and reported as estimated concentrations.

*Report Format: DU Report with 'J' Qualifiers*

**Project Name:** HAWAII DOH - FINGERPRINTING**Lab Number:** L2240634**Project Number:** Not Specified**Report Date:** 09/08/22**Footnotes**

- 1 - The reference for this analyte should be considered modified since this analyte is absent from the target analyte list of the original method.

**Terms**

Analytical Method: Both the document from which the method originates and the analytical reference method. (Example: EPA 8260B is shown as 1,8260B.) The codes for the reference method documents are provided in the References section of the Addendum.

Chlordane: The target compound Chlordane (CAS No. 57-74-9) is reported for GC ECD analyses. Per EPA, this compound "refers to a mixture of chlordane isomers, other chlorinated hydrocarbons and numerous other components." (Reference: USEPA Toxicological Review of Chlordane, In Support of Summary Information on the Integrated Risk Information System (IRIS), December 1997.)

Difference: With respect to Total Oxidizable Precursor (TOP) Assay analysis, the difference is defined as the Post-Treatment value minus the Pre-Treatment value.

Final pH: As it pertains to Sample Receipt & Container Information section of the report, Final pH reflects pH of container determined after adjustment at the laboratory, if applicable. If no adjustment required, value reflects Initial pH.

Frozen Date/Time: With respect to Volatile Organics in soil, Frozen Date/Time reflects the date/time at which associated Reagent Water-preserved vials were initially frozen. Note: If frozen date/time is beyond 48 hours from sample collection, value will be reflected in 'bold'.

Gasoline Range Organics (GRO): Gasoline Range Organics (GRO) results include all chromatographic peaks eluting from Methyl tert butyl ether through Naphthalene, with the exception of GRO analysis in support of State of Ohio programs, which includes all chromatographic peaks eluting from Hexane through Dodecane.

Initial pH: As it pertains to Sample Receipt & Container Information section of the report, Initial pH reflects pH of container determined upon receipt, if applicable.

PAH Total: With respect to Alkylated PAH analyses, the 'PAHs, Total' result is defined as the summation of results for all or a subset of the following compounds: Naphthalene, C1-C4 Naphthalenes, 2-Methylnaphthalene, 1-Methylnaphthalene, Biphenyl, Acenaphthylene, Acenaphthene, Fluorene, C1-C3 Fluorenes, Phenanthrene, C1-C4 Phenanthrenes/Anthracenes, Anthracene, Fluoranthene, Pyrene, C1-C4 Fluoranthenes/Pyrenes, Benz(a)anthracene, Chrysene, C1-C4 Chrysenes, Benzo(b)fluoranthene, Benzo(j)+(k)fluoranthene, Benzo(e)pyrene, Benzo(a)pyrene, Perylene, Indeno(1,2,3-cd)pyrene, Dibenz(ah)+(ac)anthracene, Benzo(g,h,i)perylene. If a 'Total' result is requested, the results of its individual components will also be reported.

PFAS Total: With respect to PFAS analyses, the 'PFAS, Total (5)' result is defined as the summation of results for: PFHpA, PFHxS, PFOA, PFNA and PFOS. In addition, the 'PFAS, Total (6)' result is defined as the summation of results for: PFHpA, PFHxS, PFOA, PFNA, PFDA and PFOS. For MassDEP DW compliance analysis only, the 'PFAS, Total (6)' result is defined as the summation of results at or above the RL. Note: If a 'Total' result is requested, the results of its individual components will also be reported.

Total: With respect to Organic analyses, a 'Total' result is defined as the summation of results for individual isomers or Aroclors. If a 'Total' result is requested, the results of its individual components will also be reported. This is applicable to 'Total' results for methods 8260, 8081 and 8082.

**Data Qualifiers**

- A** - Spectra identified as "Aldol Condensates" are byproducts of the extraction/concentration procedures when acetone is introduced in the process.
- B** - The analyte was detected above the reporting limit in the associated method blank. Flag only applies to associated field samples that have detectable concentrations of the analyte at less than ten times (10x) the concentration found in the blank. For MCP-related projects, flag only applies to associated field samples that have detectable concentrations of the analyte at less than ten times (10x) the concentration found in the blank. For DOD-related projects, flag only applies to associated field samples that have detectable concentrations of the analyte at less than ten times (10x) the concentration found in the blank AND the analyte was detected above one-half the reporting limit (or above the reporting limit for common lab contaminants) in the associated method blank. For NJ-Air-related projects, flag only applies to associated field samples that have detectable concentrations of the analyte above the reporting limit. For NJ-related projects (excluding Air), flag only applies to associated field samples that have detectable concentrations of the analyte, which was detected above the reporting limit in the associated method blank or above five times the reporting limit for common lab contaminants (Phthalates, Acetone, Methylene Chloride, 2-Butanone).
- C** - Co-elution: The target analyte co-elutes with a known lab standard (i.e. surrogate, internal standards, etc.) for co-extracted analyses.
- D** - Concentration of analyte was quantified from diluted analysis. Flag only applies to field samples that have detectable concentrations of the analyte.
- E** - Concentration of analyte exceeds the range of the calibration curve and/or linear range of the instrument.
- F** - The ratio of quantifier ion response to qualifier ion response falls outside of the laboratory criteria. Results are considered to be an estimated maximum concentration.
- G** - The concentration may be biased high due to matrix interferences (i.e. co-elution) with non-target compound(s). The result should be considered estimated.
- H** - The analysis of pH was performed beyond the regulatory-required holding time of 15 minutes from the time of sample collection.
- I** - The lower value for the two columns has been reported due to obvious interference.
- J** - Estimated value. The Target analyte concentration is below the quantitation limit (RL), but above the Method Detection Limit (MDL) or Estimated Detection Limit (EDL) for SPME-related analyses. This represents an estimated concentration for Tentatively

Report Format: DU Report with 'J' Qualifiers



**Project Name:** HAWAII DOH - FINGERPRINTING  
**Project Number:** Not Specified

**Lab Number:** L2240634  
**Report Date:** 09/08/22

#### **Data Qualifiers**

Identified Compounds (TICs).

- M** - Reporting Limit (RL) exceeds the MCP CAM Reporting Limit for this analyte.
- ND** - Not detected at the method detection limit (MDL) for the sample, or estimated detection limit (EDL) for SPME-related analyses.
- NJ** - Presumptive evidence of compound. This represents an estimated concentration for Tentatively Identified Compounds (TICs), where the identification is based on a mass spectral library search.
- P** - The RPD between the results for the two columns exceeds the method-specified criteria.
- Q** - The quality control sample exceeds the associated acceptance criteria. For DOD-related projects, LCS and/or Continuing Calibration Standard exceedences are also qualified on all associated sample results. Note: This flag is not applicable for matrix spike recoveries when the sample concentration is greater than 4x the spike added or for batch duplicate RPD when the sample concentrations are less than 5x the RL. (Metals only.)
- R** - Analytical results are from sample re-analysis.
- RE** - Analytical results are from sample re-extraction.
- S** - Analytical results are from modified screening analysis.
- V** - The surrogate associated with this target analyte has a recovery outside the QC acceptance limits. (Applicable to MassDEP DW Compliance samples only.)
- Z** - The batch matrix spike and/or duplicate associated with this target analyte has a recovery/RPD outside the QC acceptance limits. (Applicable to MassDEP DW Compliance samples only.)

Report Format: DU Report with 'J' Qualifiers



**Project Name:** HAWAII DOH - FINGERPRINTING

**Lab Number:** L2240634

**Project Number:** Not Specified

**Report Date:** 09/08/22

## REFERENCES

- 1 Test Methods for Evaluating Solid Waste: Physical/Chemical Methods. EPA SW-846. Third Edition. Updates I - VI, 2018.
- 131 Method for the Determination of Volatile Petroleum Hydrocarbons (VPH), MassDEP, February 2018, Revision 2.1 with QC Requirements & Performance Standards for the Analysis of VPH under the Massachusetts Contingency Plan, WSC-CAM-IVA, June 1, 2018.

## LIMITATION OF LIABILITIES

Alpha Analytical performs services with reasonable care and diligence normal to the analytical testing laboratory industry. In the event of an error, the sole and exclusive responsibility of Alpha Analytical shall be to re-perform the work at it's own expense. In no event shall Alpha Analytical be held liable for any incidental, consequential or special damages, including but not limited to, damages in any way connected with the use of, interpretation of, information or analysis provided by Alpha Analytical.

We strongly urge our clients to comply with EPA protocol regarding sample volume, preservation, cooling, containers, sampling procedures, holding time and splitting of samples in the field.



## Certification Information

---

The following analytes are not included in our Primary NELAP Scope of Accreditation:

### Westborough Facility

**EPA 624/624.1:** m/p-xylene, o-xylene, Naphthalene

**EPA 625/625.1:** alpha-Terpineol

**EPA 8260C/8260D:** NPW: 1,2,4,5-Tetramethylbenzene; 4-Ethyltoluene, Azobenzene; SCM: Iodomethane (methyl iodide), 1,2,4,5-Tetramethylbenzene; 4-Ethyltoluene.

**EPA 8270D/8270E:** NPW: Dimethylnaphthalene, 1,4-Diphenylhydrazine, alpha-Terpineol; SCM: Dimethylnaphthalene, 1,4-Diphenylhydrazine.

**SM4500:** NPW: Amenable Cyanide; SCM: Total Phosphorus, TKN, NO<sub>2</sub>, NO<sub>3</sub>.

### Mansfield Facility

**SM 2540D:** TSS

**EPA 8082A:** NPW: PCB: 1, 5, 31, 87,101, 110, 141, 151, 153, 180, 183, 187.

**EPA TO-15:** Halothane, 2,4,4-Trimethyl-2-pentene, 2,4,4-Trimethyl-1-pentene, Thiophene, 2-Methylthiophene,

3-Methylthiophene, 2-Ethylthiophene, 1,2,3-Trimethylbenzene, Indan, Indene, 1,2,4,5-Tetramethylbenzene, Benzothiophene, 1-Methylnaphthalene.

**Biological Tissue Matrix:** EPA 3050B

---

The following analytes are included in our Massachusetts DEP Scope of Accreditation

### Westborough Facility:

#### Drinking Water

**EPA 300.0:** Chloride, Nitrate-N, Fluoride, Sulfate; **EPA 353.2:** Nitrate-N, Nitrite-N; **SM4500NO3-F:** Nitrate-N, Nitrite-N; **SM4500F-C, SM4500CN-CE,**

**EPA 180.1, SM2130B, SM4500CI-D, SM2320B, SM2540C, SM4500H-B, SM4500NO2-B**

**EPA 332:** Perchlorate; **EPA 524.2:** THMs and VOCs; **EPA 504.1:** EDB, DBCP.

**Microbiology:** **SM9215B; SM9223-P/A, SM9223B-Colilert-QT, SM9222D.**

#### Non-Potable Water

**SM4500H,B, EPA 120.1, SM2510B, SM2540C, SM2320B, SM4500CL-E, SM4500F-BC, SM4500NH3-BH:** Ammonia-N and Kjeldahl-N, **EPA 350.1:**

Ammonia-N, **LCHAT 10-107-06-1-B:** Ammonia-N, **EPA 351.1, SM4500NO3-F, EPA 353.2:** Nitrate-N, **SM4500P-E, SM4500P-B, E, SM4500SO4-E,**

**SM5220D, EPA 410.4, SM5210B, SM5310C, SM4500CL-D, EPA 1664, EPA 420.1, SM4500-CN-CE, SM2540D, EPA 300:** Chloride, Sulfate, Nitrate.

**EPA 624.1:** Volatile Halocarbons & Aromatics,

**EPA 608.3:** Chlordane, Toxaphene, Aldrin, alpha-BHC, beta-BHC, gamma-BHC, delta-BHC, Dieldrin, DDD, DDE, DDT, Endosulfan I, Endosulfan II,

Endosulfan sulfate, Endrin, Endrin Aldehyde, Heptachlor, Heptachlor Epoxide, PCBs

**EPA 625.1:** SVOC (Acid/Base/Neutral Extractables), **EPA 600/4-81-045:** PCB-Oil.

**Microbiology:** **SM9223B-Colilert-QT; Enterolert-QT, SM9221E, EPA 1600, EPA 1603, SM9222D.**

### Mansfield Facility:

#### Drinking Water

**EPA 200.7:** Al, Ba, Cd, Cr, Cu, Fe, Mn, Ni, Na, Ag, Ca, Zn. **EPA 200.8:** Al, Sb, As, Ba, Be, Cd, Cr, Cu, Pb, Mn, Ni, Se, Ag, TL, Zn. **EPA 245.1 Hg.**

**EPA 522, EPA 537.1.**

#### Non-Potable Water

**EPA 200.7:** Al, Sb, As, Be, Cd, Ca, Cr, Co, Cu, Fe, Pb, Mg, Mn, Mo, Ni, K, Se, Ag, Na, Sr, TL, Ti, V, Zn.

**EPA 200.8:** Al, Sb, As, Be, Cd, Cr, Cu, Fe, Pb, Mn, Ni, K, Se, Ag, Na, TL, Zn.

**EPA 245.1 Hg.**

**SM2340B**

---

For a complete listing of analytes and methods, please contact your Alpha Project Manager.



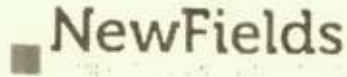

# Chain of Custody

Environmental Forensics Practice LLC

L2240634

Proj. No		Proj. Name		Hawaii DOH - Fingerprinting		ANALYSIS REQUESTED → "NUMBER OF CONTAINERS"		MATRIX (Oil/Soil/Water)	GC-FID-TPH (C <sub>8</sub> +)	F1 & F2 Fractions	VPH-FID (MAVPH)	PIANO - VOA							
SAMPLERS: Signature <b>Eric Limer</b>																			
DATE	TIME	LAB ID	CLIENT ID	SAMPLE DESCRIPTION															
7/26/2022		40634-01,02,03	Gasoline 87	L1801304-09A		0	x	x	x	x									
7/26/2022		04,05,06	Gasoline 91	L1801304-10A		0	x	x	x	x									
7/26/2022		07,08,09	Gasoline 93	L1801304-12A		0	x	x	x	x									
7/26/2022		10,11,12	Heating Fuel	1611003-02A		0	x	x	x	x									
7/26/2022		13,14,15	Road Diesel	L1801304-11A		0	x	x	x	x									
7/26/2022		16,17,18	JP-5	AccuStandard - FU-012-D-40x		0	x	x	x	x									
7/26/2022		19,20,21	JP-8	AccuStandard - FU-013-D-40x		0	x	x	x	x									
7/26/2022	-32, -33, -34	22,23,24	Waste Oil (auto)	0509022-05		0	x	x	x	x									
7/26/2022		25,26,27	Bunker C	L2052433-03A		0	x	x	x	x									
Relinquished by:				Date/Time	7/29/22 9:20A		Received by:				Date/Time		7/29/22 09:20						
Relinquished by:				Date/Time			Received by:				Date/Time								
Comments:		Samples to be shipped to: Alpha Laboratory 320 Forbes Blvd. Mansfield, MA 02048 Tel: (508) 822-9300 Attn: Sue Oneil																	



8/8/22

Chain of Custody

L2240634

Environmental Forensics Practice LLC

Proj. No		Proj. Name Hawaii's DOH													
SAMPLERS: Signature ERIC Litman															
ANALYSIS REQUESTED → "NUMBER OF CONTAINERS"															
DATE	TIME	LAB ID	CLIENT ID	SAMPLE DESCRIPTION	MATRIX (* see below)	GC-FID-TPH (C,+)	GCMS-Alkyl PAH	GCMS-Biomarkers	PIANO - VOA	Organic Lead	METALS	PCB	Pesticides	PRESERVED	Total Number of Containers
8/8/22		-28	JP-5	MEOH	P	X			X						
8/8/22		-29	JP-8	MEOH	P	X			X						
Relinquished by:		Date/Time		Received by:		Date/Time									
		8/8/2022 1:46		Doy DeLoe AAL		8/8/22 13:46									
Relinquished by:		Date/Time		Received by:		Date/Time									
Doy DeLoe AAL		8/8/22 16:45		Lyle DeLoe		8/8/22 16:45									
Relinquished by:		Date/Time		Received by:		Date/Time									
mhr wa		8/8/22 19:00		R. Mendez		8/8/22 19:00									
* O=Oil SO=Soil SE=Sediment T=Tissue W=Water		Samples to be shipped to: Alpha Laboratory 320 Forbes Blvd. Mansfield, MA 02048 Tel: (508) 844-4117 Attn: Sue O'Neil		Comments:											

R. Mendez

8/8/22 20:00

8/8/22 20:00



# Chain of Custody

## Environmental Forensics Practice LLC

L2240634

Proj. No		Proj. Name														
SAMPLERS: Signature				ANALYSIS REQUESTED → "NUMBER OF CONTAINERS"		MATRIX (* see below)	GC-FID-TPH (C++)	GCMS-Alkyl PAH	GCMS-Biomarkers	PIANO - VOA	Organic Lead	METALS	PCB	Pesticides	PRESERVED	Total Number of Containers
George Hill		[Signature]														
DATE	TIME	LAB ID	CLIENT ID	SAMPLE DESCRIPTION												
8/17/22	12:15	Acas	Acutox Standard	Standard		Liquid									1	
Relinquished by:			Date/Time		Received by:			Date/Time								
[Signature]			8/17/22 12:15		Dm Deere AAL			9/17/22 12:15								
Relinquished by:			Date/Time		Received by:			Date/Time								
Dm Deere AAL			8/17/22 16:50		Lyle Harri			8/17/22 16:50								
Relinquished by:			Date/Time		Received by:			Date/Time								
Meghan Murphy			8/17/22 19:00		[Signature]			8/17/22 19:00								
* O=Oil SO=Soil SE=Sediment T=Tissue W=Water			Samples to be shipped to: Alpha Laboratory 320 Forbes Blvd. Mansfield, MA 02048 Tel: (508) 844-4117 Attn: Sue O'Neil			Comments:										

30  
31

[Signature] 8/17/22 2000

## Quantitation Report (QT Reviewed)

Data Path : I:\VOLATILES\_GC\PVPH\2022\220902Aali\  
Data File : P220902A33.D  
Signal(s) : FID2B.ch  
Acq On : 3 Sep 2022 1:23 am  
Operator : PVPH:BAD  
Sample : 12240634-25d,41,10,1.17,0.005,,w  
Misc : WG1684889,ICAL19300,VPH-50  
ALS Vial : 33 Sample Multiplier: 1

Integration File: autoint1.e  
Quant Time: Sep 03 13:07:22 2022  
Quant Method : I:\VOLATILES\_GC\PVPH\2022\220902Aali\vph-ali220830A.m  
Quant Title : VPH ALIPHATIC  
QLast Update : Wed Aug 31 12:33:08 2022  
Response via : Initial Calibration  
Integrator: ChemStation

Volume Inj. :  
Signal Phase :  
Signal Info :

Sub List : Default - All compounds listed

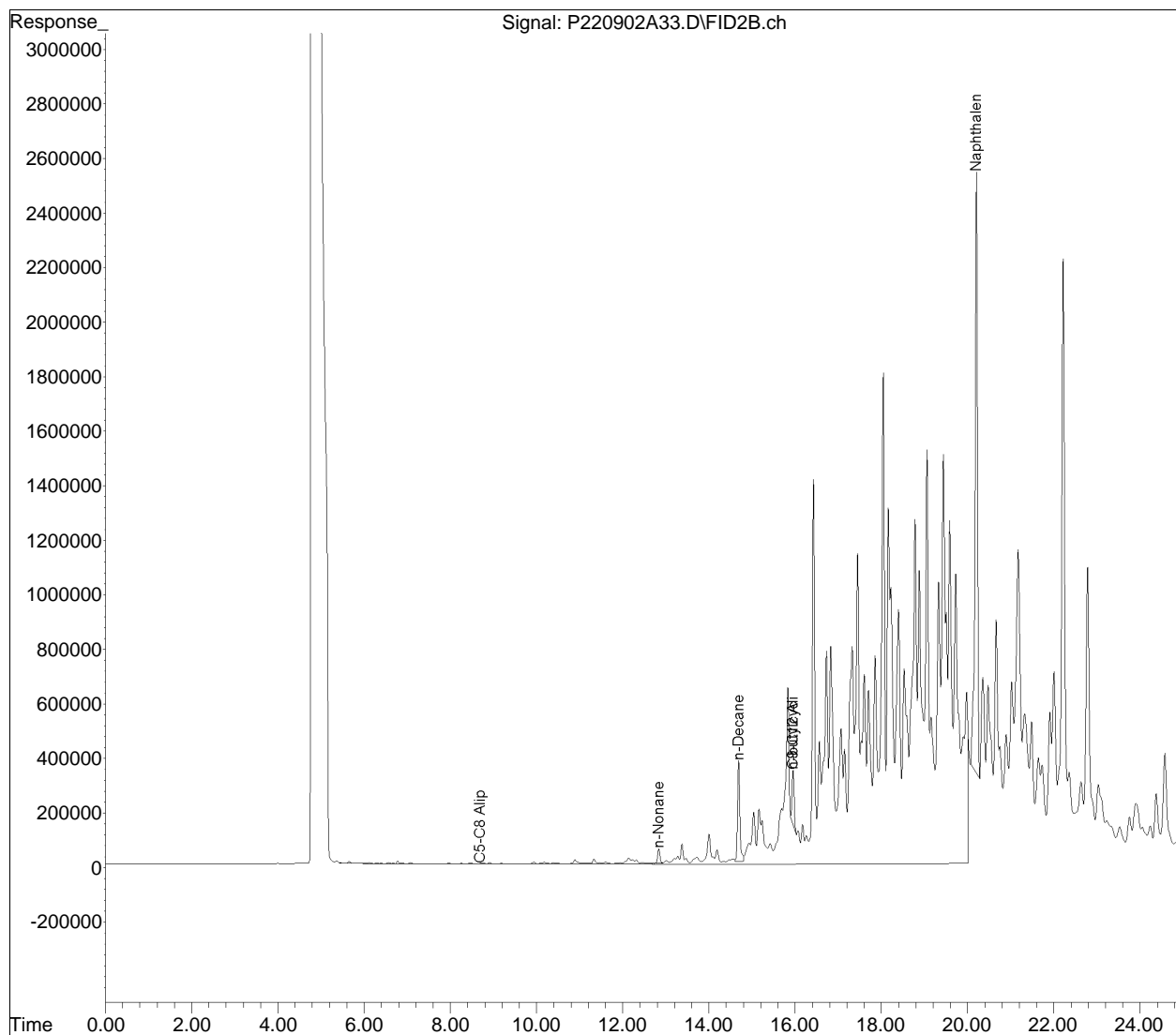

## Quantitation Report (QT Reviewed)

Data Path : I:\VOLATILES\_GC\PVPH\2022\220902Aaro\  
Data File : P220902A33.D  
Signal(s) : CPDET1A.ch  
Acq On : 3 Sep 2022 1:23 am  
Operator : PVPH:BAD  
Sample : 12240634-25d,41,10,1.17,0.005,,w  
Misc : WG1684889,ICAL19301,VPH-50  
ALS Vial : 33 Sample Multiplier: 1

Integration File: autoint1.e  
Quant Time: Sep 03 13:53:04 2022  
Quant Method : I:\VOLATILES\_GC\PVPH\2022\220902Aaro\vph-aro220830A.m  
Quant Title : VPH AROMATIC  
QLast Update : Wed Aug 31 12:38:17 2022  
Response via : Initial Calibration  
Integrator: ChemStation

Volume Inj. :  
Signal Phase :  
Signal Info :

Sub List : Default - All compounds listed

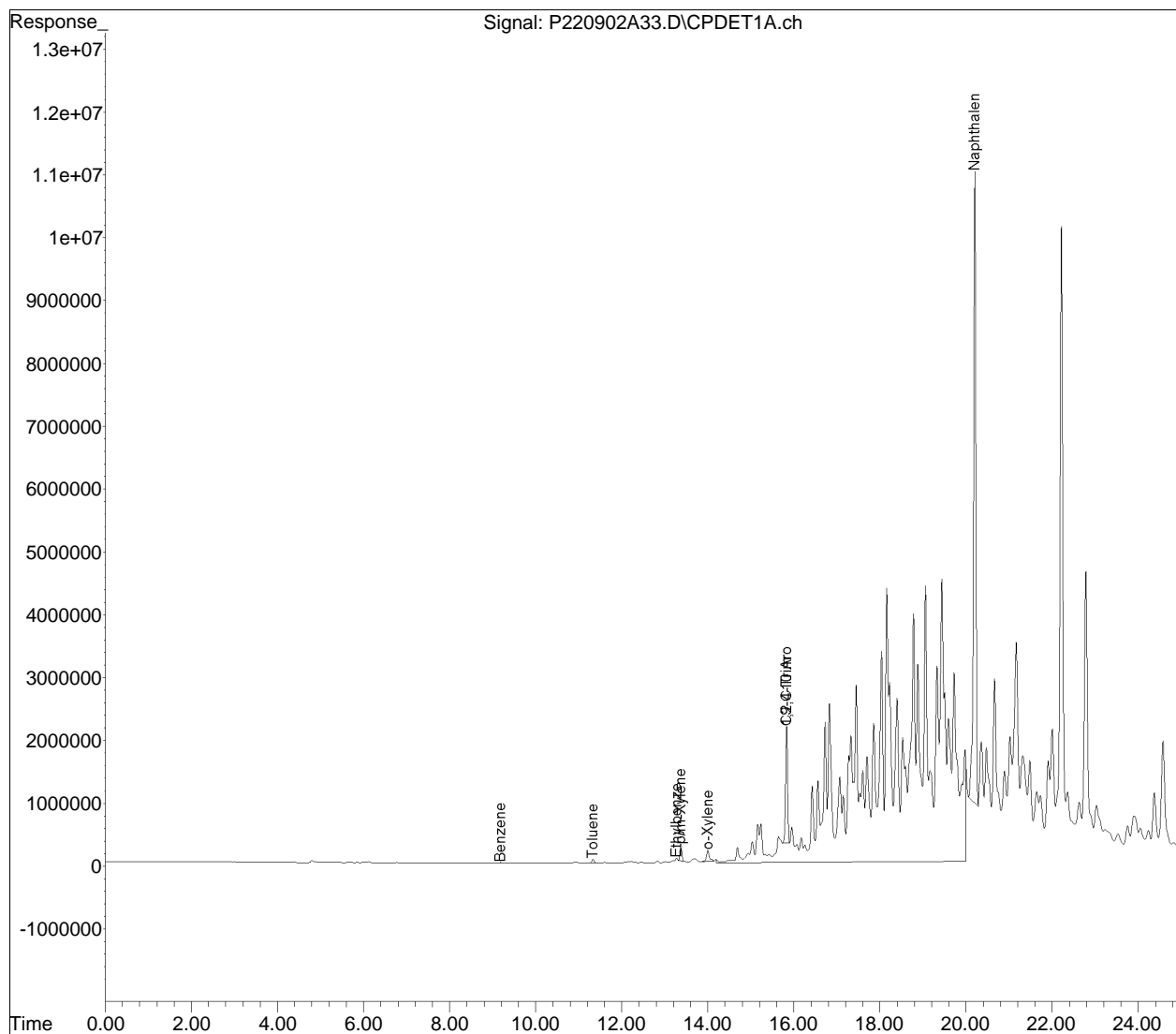

## Quantitation Report (QT Reviewed)

Data Path : I:\VOLATILES\_GC\PVPH\2022\220902Aali\  
Data File : P220902A35.D  
Signal(s) : FID2B.ch  
Acq On : 3 Sep 2022 2:22 am  
Operator : PVPH:BAD  
Sample : 12240634-32d,41,10,1.01,0.02,,z  
Misc : WG1684889,ICAL19300,VPH-50  
ALS Vial : 35 Sample Multiplier: 1

Integration File: autoint1.e  
Quant Time: Sep 03 13:08:26 2022  
Quant Method : I:\VOLATILES\_GC\PVPH\2022\220902Aali\vph-ali220830A.m  
Quant Title : VPH ALIPHATIC  
QLast Update : Wed Aug 31 12:33:08 2022  
Response via : Initial Calibration  
Integrator: ChemStation

Volume Inj. :  
Signal Phase :  
Signal Info :

Sub List : Default - All compounds listed

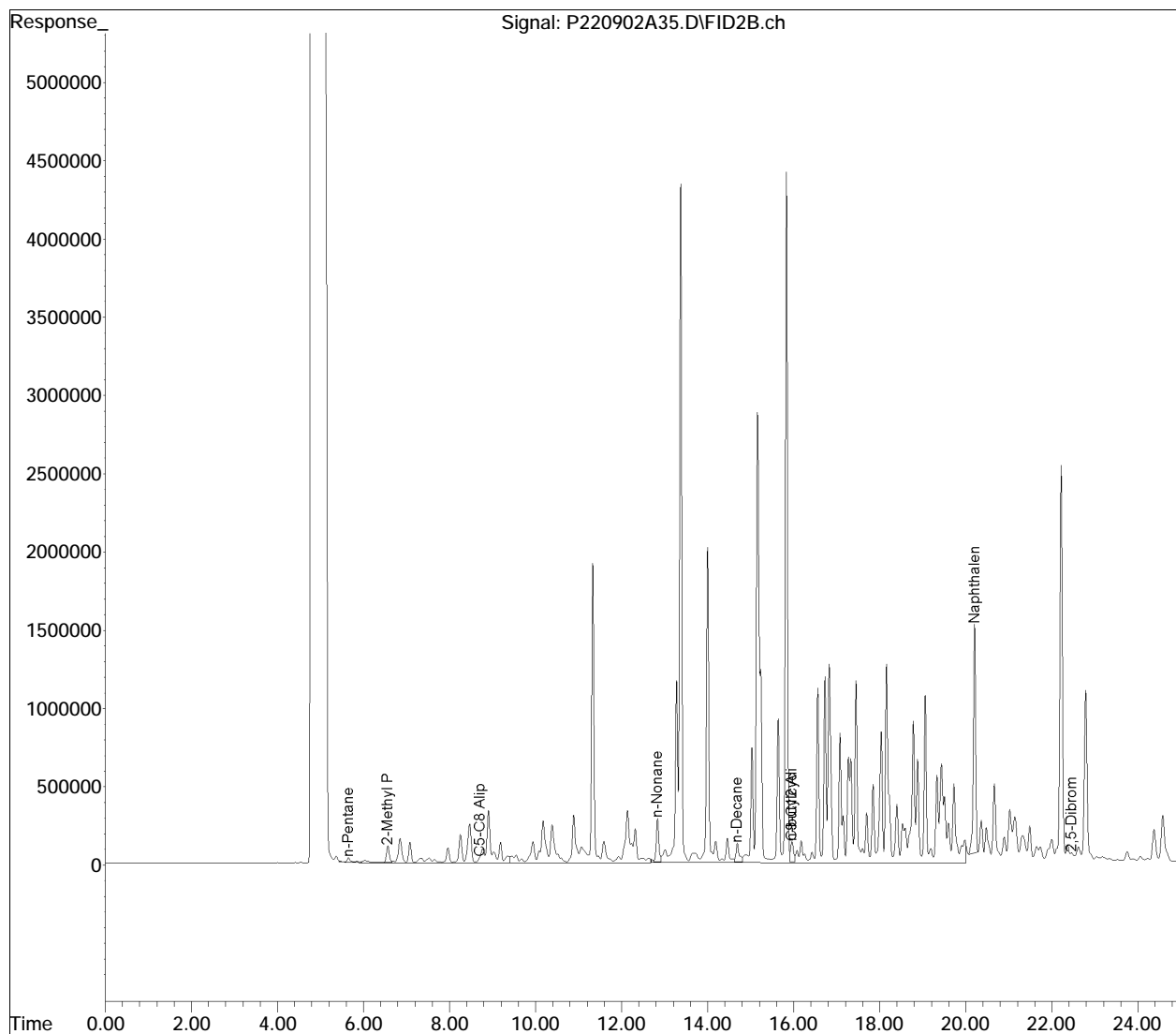

# **JP-5 Water-Fuel Study Laboratory Report (HIDOH 2023b)**

July 28<sup>th</sup>, 2023

Dr. Roger Brewer  
 Hawaii Department of Health  
 919 Ala Moana Boulevard  
 Honolulu, HI 96813

Cc: Eric M. Jensen  
 Tetra Tech, Inc.

Dr. Brewer,

This memo provides a summary of the JP-5 water accommodated fraction (WAF) study conducted by NewFields Environmental Forensics (Rockland, MA) and Alpha Analytical, Inc. (Mansfield, MA) on behalf of the Hawaii Department of Health (DOH). The experiment was initiated on March 30<sup>th</sup>, 2023, and was concluded on April 20<sup>th</sup>, 2023.

**Introduction**

The study was focused on characterizing the aliphatic and aromatic hydrocarbon fractions, and the dispersant and additives present in JP-5 WAF samples prepared for this experiment. The WAF study samples were prepared by applying 10 mL of JP-5 jet fuel to 1 L of deionized water. The study prepared individual, time-sequenced WAF samples to be collected and analyzed on 5-day intervals beginning on Day 0, and then collected subsequently on Days 5, 10, 15 and 20. The experiment was conducted in duplicate and included a second set of WAF samples prepared with 10 mL of JP-5 jet fuel, 1 L of deionized water and 100 uL of Simple Green *Extreme Aircraft and Precision Cleaner*. The duplicate experiment was conducted using Simple Green to assess the effect of this dispersant on the dissolution or degradation of JP-5 Jet Fuel in the WAF samples. The WAF samples were tested by methods modified for forensic analysis. The samples were analyzed by Modified EPA Method 8260C-PIANO, and Modified EPA Method 8015C-Total Petroleum Hydrocarbons (TPH). Select samples were analyzed by Modified EPA Method 8270E for fuel additives and dispersants, and EPA Method TO-15 for vapor phase hydrocarbons. A detailed description of the purpose and scope of this study can be found in the *Chemistry and Toxicity of Dissolved-Phase Petroleum Fuel* (Brewer, 2021).

**Table 1: Sample Analysis Summary**

Sample Name	Collection Date	EPA Method			
		Modified 8260C-PIANO	Modified 8015C-TPH	Modified 8270E-Additives	Modified TO-15 Vapor
Day 0 - JP-5	3/31/2023	x	x		x
Day 0 - JP-5 + Simple Green	3/31/2023	x	x	x	x
Day 5 - JP-5	4/5/2023	x	x		
Day 5 - JP-5 + Simple Green	4/5/2023	x	x	x	
Day 10 - JP-5	4/10/2023	x	x		
Day 10 - JP-5 + Simple Green	4/10/2023	x	x	x	
Day 15 - JP-5	4/15/2023	x	x		
Day 15 - JP-5 + Simple Green	4/15/5023	x	x	x	
Day 20 - JP-5	4/20/2023	x	x		x
Day 20 - JP-5 + Simple Green	4/20/2023	x	x	x	x

**Summary of Analytical Methodology**

Alpha Analytical (Alpha) tested all WAF samples by EPA Method 8260C-PIANO for a full list of C5-



C13 volatile petroleum hydrocarbons, and by EPA Method 8015C for C9-C44 Total Petroleum Hydrocarbons. WAF samples that were dosed with Simple Green were also tested by EPA Method 8270E for additive and dispersant analysis. Head space vapor samples were collected from Day 0 and Day 20 WAF samples and were tested by EPA Method TO-15 for vapor phase hydrocarbons. The Alpha Analytical data packages are attached to this report and can be referenced for results and supporting laboratory documentation.

In addition to the conventional laboratory testing performed by Alpha Analytical, NewFields Environmental Forensics performed a series of extended analysis on the raw laboratory data. Using the raw laboratory data collected by Alpha, Newfields processed the TO-15 vapor phase data, the 8015C-TPH data, and the 8270E-Additive data for an extended list of aliphatic and aromatic carbon range fractions, and for additive and dispersant indicator compounds. A full list of the extended analytes is listed in Table 2. The supporting raw data and integrations for these analytes can be found attached to this report in the Detailed Quant Report addendum.

**Table 2:** Analyte Summary of Extended Data Processing

Method	Class	Analyte
TO-15-Vapor	Aliphatic	C5-C8 Aliphatics
TO-15-Vapor	Aliphatic	C9-C12+ Aliphatics
TO-15-Vapor	Aromatic	C9-C12+ Aromatics
PIANO-VOCs	Aliphatic	C5-C6 Aliphatics
PIANO-VOCs	Aliphatic	>C6-C8 Aliphatics
8015C-TPH	Aliphatic	>C8-C10 Aliphatics
8015C-TPH	Aliphatic	>C10-C12 Aliphatics
8015C-TPH	Aliphatic	>C12-C16 Aliphatics
8015C-TPH	Aliphatic	>C16-C21 Aliphatics
8015C-TPH	Aliphatic	>C21-C32 Aliphatics
8015C-TPH	Aromatic	>C8-C10 Aromatics
8015C-TPH	Aromatic	>C10-C12 Aromatics
8015C-TPH	Aromatic	>C12-C16 Aromatics
8015C-TPH	Aromatic	>C16-C21 Aromatics
8015C-TPH	Aromatic	>C21-C32 Aromatics
8270E-Additives	Additive	2(2-methoxyethoxy)-ethanol
8270E-Additives	Additive	1-butoxy-2-propanol

## Reporting

The results reported in this experiment include concentrations reported in mg/L for aqueous samples, mg/kg<sub>oil</sub> for the JP-5 jet fuel product, and ug/m<sup>3</sup> for vapor samples. The report also includes GC/FID and GC/MS chromatograms (aliphatic, aromatic, and combined extracts), and the detailed raw data quantitation reports that record the integration of each carbon range. I am available to discuss this data further at your convenience.

Sincerely,



Eric Litman, M.S.  
Senior Consultant  
NewFields Environmental Forensics

Attached:

- Attachment A: Carbon Range and Additive Summary Data Report
- Attachment B: Quantitation Raw Data Reports
- Attachment C: Alpha Analytical Data Packages

<b>Experiment Day</b>	<b>NA</b>
Sample Matrix	Product
Fuel	JP-5
Fuel to Water Ratio	NA
Dispersent	None
Client ID	JP-5 NEAT FUEL
Lab ID	L2259785-01
Matrix	OIL
Reference Method	8015D(M)
Batch ID	WG1742147
Date Collected	8/2/2022
Date Received	10/26/2022
Date Prepped	2/8/2023
Date Analyzed	2/10/2023
Sample Size(wet)	0.103
% Solid	100
File ID	f18021023020

Method	Abbrev	Analytes	Units	Result	Q	RL
TO-15-Vapor	B	Benzene	µg/m³	3,180		163
TO-15-Vapor	T	Toluene	µg/m³	30,600		192
TO-15-Vapor	EB	Ethylbenzene	µg/m³	21,300		222
TO-15-Vapor	MPX	P/M-Xylene	µg/m³	71,200		443
TO-15-Vapor	OX	O-Xylene	µg/m³	37,100		222
TO-15-Vapor	N0	Naphthalene	µg/m³	6,080		267
TO-15-Vapor	2MN	2-Methylnaphthalene	µg/m³	3,649		267
TO-15-Vapor	1MN	1-Methylnaphthalene	µg/m³	2,743		267
TO-15-Vapor	Aliphatic	C5-C8 Aliphatics	µg/m³	2,211,128		180
TO-15-Vapor	Aliphatic	C9-C12+ Aliphatics	µg/m³	9,165,198		180
TO-15-Vapor	Aromatic	C9-C12+ Aromatics	µg/m³	373,769		440
PIANO-VOCs	B	Benzene	mg/kg	22.6	J	89.2
PIANO-VOCs	T	Toluene	mg/kg	187		89.2
PIANO-VOCs	EB	Ethylbenzene	mg/kg	279		89.2
PIANO-VOCs	MPX	P/M-Xylene	mg/kg	1350		89.2
PIANO-VOCs	OX	O-Xylene	mg/kg	739		89.2
PIANO-VOCs	N0	Naphthalene	mg/kg	2890		89.2
PIANO-VOCs	2MN	2-Methylnaphthalene	mg/kg	5440		89.2
PIANO-VOCs	1MN	1-Methylnaphthalene	mg/kg	3590		89.2
PIANO-VOCs	Aliphatic	C5-C6 Aliphatics	mg/kg	163		89.2
PIANO-VOCs	Aliphatic	>C6-C8 Aliphatics	mg/kg	1,073		89.2
8015B-TPH	Aliphatic	>C8-C10 Aliphatics	mg/kg	41,036		1,280
8015B-TPH	Aliphatic	>C10-C12 Aliphatics	mg/kg	246,692		1,280
8015B-TPH	Aliphatic	>C12-C16 Aliphatics	mg/kg	322,432		1,280
8015B-TPH	Aliphatic	>C16-C21 Aliphatics	mg/kg	5,030		1,280
8015B-TPH	Aliphatic	>C21-C32 Aliphatics	mg/kg		U	1,280
8015B-TPH	Aromatic	>C8-C10 Aromatics	mg/kg	7,755		1,280
8015B-TPH	Aromatic	>C10-C12 Aromatics	mg/kg	44,846		1,280
8015B-TPH	Aromatic	>C12-C16 Aromatics	mg/kg	81,015		1,280
8015B-TPH	Aromatic	>C16-C21 Aromatics	mg/kg	1,769		1,280
8015B-TPH	Aromatic	>C21-C32 Aromatics	mg/kg		U	1,280
8015B-TPH	Combined	>C8-C10 Combined	mg/kg	78,820		6,410
8015B-TPH	Combined	>C10-C12 Combined	mg/kg	385,562		6,410
8015B-TPH	Combined	>C12-C16 Combined	mg/kg	441,165		6,410
8015B-TPH	Combined	>C16-C21 Combined	mg/kg	17,254		6,410
8015B-TPH	Combined	>C21-C32 Combined	mg/kg		U	6,410
8015B-TPH	Combined	TPH (C9-C44)	mg/kg	923,000		6,410
8015B-TPH	Aliphatic	TPH (C9-C44) - F1 Aliphatics	mg/kg	623,000		6,410
8015B-TPH	Aromatic	TPH (C9-C44) - F2 Aromatics	mg/kg	135,000		6,410

**Semi-Quantitative**

8270-Full Scan Additives	2(2-methoxyethoxy)-ethanol	NA
8270-Full Scan Dispersent	1-butoxy-2-propanol	NA

Experiment Day	Day 0	Day 0
Sample Matrix	WAF	WAF
Fuel	JP-5	JP-5
Fuel to Water Ratio	1:100	1:100
Dispersent	None	Simple Green
Client ID	DAY0-JP-5_2	DAY0-JP-5+SG_2
Lab ID	L2317027-01	L2317027-04
Matrix	WATER	WATER
Reference Method	8015D(M)	8015D(M)
Batch ID	WG1763893	WG1763893
Date Collected	3/31/2023	3/31/2023
Date Received	3/31/2023	3/31/2023
Date Prepped	4/7/2023	4/7/2023
Date Analyzed	4/28/2023	4/28/2023
Sample Size(wet)	850	850
% Solid	100	100
File ID	f18042723045	f18042723047

Method	Abbrev	Analytes	Units	Result	Q	RL	Result	Q	RL
TO-15-Vapor	B	Benzene	µg/m³	3,020		266	3,060		271
TO-15-Vapor	T	Toluene	µg/m³	27,000		314	26,900		319
TO-15-Vapor	EB	Ethylbenzene	µg/m³	16,000		362	16,500		368
TO-15-Vapor	MPX	P/M-Xylene	µg/m³	53,900		725	55,600		734
TO-15-Vapor	OX	O-Xylene	µg/m³	27,100		362	28,400		368
TO-15-Vapor	N0	Naphthalene	µg/m³	4,020		437	4,790		444
TO-15-Vapor	2MN	2-Methylnaphthalene	µg/m³	2,129		437	1,745		444
TO-15-Vapor	1MN	1-Methylnaphthalene	µg/m³	3,245		437	2,821		444
TO-15-Vapor	Aliphatic	C5-C8 Aliphatics	µg/m³	1,869,813		294	1,859,635		294
TO-15-Vapor	Aliphatic	C9-C12+ Aliphatics	µg/m³	7,269,452		294	7,849,978		294
TO-15-Vapor	Aromatic	C9-C12+ Aromatics	µg/m³	295,282		362	316,860		362
PIANO-VOCs	B	Benzene	mg/kg	0.00235		0.002	0.00243		0.002
PIANO-VOCs	T	Toluene	mg/kg	0.0188		0.002	0.0203		0.002
PIANO-VOCs	EB	Ethylbenzene	mg/kg	0.00783		0.002	0.00891		0.002
PIANO-VOCs	MPX	P/M-Xylene	mg/kg	0.0362		0.002	0.0413		0.002
PIANO-VOCs	OX	O-Xylene	mg/kg	0.0238		0.002	0.0269		0.002
PIANO-VOCs	N0	Naphthalene	mg/kg	0.0611		0.002	0.065		0.002
PIANO-VOCs	2MN	2-Methylnaphthalene	mg/kg	0.0285		0.002	0.0307		0.002
PIANO-VOCs	1MN	1-Methylnaphthalene	mg/kg	0.0206		0.002	0.0219		0.002
PIANO-VOCs	Aliphatic	C5-C6 Aliphatics	mg/kg		U	0.002		U	0.002
PIANO-VOCs	Aliphatic	>C6-C8 Aliphatics	mg/kg		U	0.002		U	0.002
8015B-TPH	Aliphatic	>C8-C10 Aliphatics	mg/kg		U	0.078		U	0.078
8015B-TPH	Aliphatic	>C10-C12 Aliphatics	mg/kg		U	0.078		U	0.078
8015B-TPH	Aliphatic	>C12-C16 Aliphatics	mg/kg		U	0.078		U	0.078
8015B-TPH	Aliphatic	>C16-C21 Aliphatics	mg/kg		U	0.078		U	0.078
8015B-TPH	Aliphatic	>C21-C32 Aliphatics	mg/kg		U	0.078		U	0.078
8015B-TPH	Aromatic	>C8-C10 Aromatics	mg/kg	0.085		0.078	0.083		0.078
8015B-TPH	Aromatic	>C10-C12 Aromatics	mg/kg	0.177		0.078	0.155		0.078
8015B-TPH	Aromatic	>C12-C16 Aromatics	mg/kg	0.138		0.078	0.119		0.078
8015B-TPH	Aromatic	>C16-C21 Aromatics	mg/kg		U	0.078		U	0.078
8015B-TPH	Aromatic	>C21-C32 Aromatics	mg/kg		U	0.078		U	0.078
8015B-TPH	Combined	>C8-C10 Combined	mg/kg	0.230		0.078	0.389		0.078
8015B-TPH	Combined	>C10-C12 Combined	mg/kg	0.354		0.078	0.369		0.078
8015B-TPH	Combined	>C12-C16 Combined	mg/kg	0.484		0.078	0.526		0.078
8015B-TPH	Combined	>C16-C21 Combined	mg/kg	0.118		0.078	0.138		0.078
8015B-TPH	Combined	>C21-C32 Combined	mg/kg		U	0.078	0.091		0.078
8015B-TPH	Combined	TPH (C9-C44)	mg/kg	1.26		0.078	1.68		0.078
8015B-TPH	Aliphatic	TPH (C9-C44) - F1 Aliphatics	mg/kg	0.0170	J	0.078	0.0230	J	0.078
8015B-TPH	Aromatic	TPH (C9-C44) - F2 Aromatics	mg/kg	0.477		0.078	0.343		0.078

Semi-Quantitative				Q	RL	Result	Q	RL
8270-Full Scan	Additives	2(2-methoxyethoxy)-ethanol		0.049		1.0	0.045	1.0
8270-Full Scan	Dispersent	1-butoxy-2-propanol		0.000		1.0	0.035	1.0

Experiment Day	Day 5	Day 5
Sample Matrix	WAF	WAF
Fuel	JP-5	JP-5
Fuel to Water Ratio	1:100	1:100
Dispersent	None	Simple Green
Client ID	DAY5-JP-5_2	DAY5-JP-5_2+SG_2
Lab ID	L2317027-07	L2317027-10
Matrix	WATER	WATER
Reference Method	8015D(M)	8015D(M)
Batch ID	WG1763893	WG1763893
Date Collected	4/5/2023	4/5/2023
Date Received	4/5/2023	4/5/2023
Date Prepped	4/7/2023	4/7/2023
Date Analyzed	4/28/2023	4/28/2023
Sample Size(wet)	830	830
% Solid	100	100
File ID	f18042723049	f18042723051

Method	Abbrev	Analytes	Units	Result	Q	RL	Result	Q	RL
TO-15-Vapor	B	Benzene	µg/m³						
TO-15-Vapor	T	Toluene	µg/m³						
TO-15-Vapor	EB	Ethylbenzene	µg/m³						
TO-15-Vapor	MPX	P/M-Xylene	µg/m³						
TO-15-Vapor	OX	O-Xylene	µg/m³						
TO-15-Vapor	N0	Naphthalene	µg/m³						
TO-15-Vapor	2MN	2-Methylnaphthalene	µg/m³						
TO-15-Vapor	1MN	1-Methylnaphthalene	µg/m³						
TO-15-Vapor	Aliphatic	C5-C8 Aliphatics	µg/m³						
TO-15-Vapor	Aliphatic	C9-C12+ Aliphatics	µg/m³						
TO-15-Vapor	Aromatic	C9-C12+ Aromatics	µg/m³						
PIANO-VOCs	B	Benzene	mg/L	0.0128		0.002	0.0121		0.002
PIANO-VOCs	T	Toluene	mg/L	0.158		0.002	0.159		0.002
PIANO-VOCs	EB	Ethylbenzene	mg/L	0.0838		0.002	0.0874		0.002
PIANO-VOCs	MPX	P/M-Xylene	mg/L	0.378		0.002	0.400		0.002
PIANO-VOCs	OX	O-Xylene	mg/L	0.250		0.002	0.241		0.002
PIANO-VOCs	N0	Naphthalene	mg/L	0.612		0.002	0.602		0.002
PIANO-VOCs	2MN	2-Methylnaphthalene	mg/L	0.318		0.002	0.308		0.002
PIANO-VOCs	1MN	1-Methylnaphthalene	mg/L	0.233		0.002	0.228		0.002
PIANO-VOCs	Aliphatic	C5-C6 Aliphatics	mg/L		U	0.002		U	0.002
PIANO-VOCs	Aliphatic	>C6-C8 Aliphatics	mg/L	0.0078		0.002	0.0079		0.002
8015B-TPH	Aliphatic	>C8-C10 Aliphatics	mg/L		U	0.08		U	0.08
8015B-TPH	Aliphatic	>C10-C12 Aliphatics	mg/L		U	0.08		U	0.08
8015B-TPH	Aliphatic	>C12-C16 Aliphatics	mg/L		U	0.08		U	0.08
8015B-TPH	Aliphatic	>C16-C21 Aliphatics	mg/L		U	0.08		U	0.08
8015B-TPH	Aliphatic	>C21-C32 Aliphatics	mg/L		U	0.08		U	0.08
8015B-TPH	Aromatic	>C8-C10 Aromatics	mg/L	0.657		0.08	0.64		0.08
8015B-TPH	Aromatic	>C10-C12 Aromatics	mg/L	1.23		0.08	1.22		0.08
8015B-TPH	Aromatic	>C12-C16 Aromatics	mg/L	0.79		0.08	0.79		0.08
8015B-TPH	Aromatic	>C16-C21 Aromatics	mg/L		U	0.08		U	0.08
8015B-TPH	Aromatic	>C21-C32 Aromatics	mg/L		U	0.08		U	0.08
8015B-TPH	Combined	>C8-C10 Combined	mg/L	1.13		0.08	1.42		0.08
8015B-TPH	Combined	>C10-C12 Combined	mg/L	1.91		0.08	2.10		0.08
8015B-TPH	Combined	>C12-C16 Combined	mg/L	1.79		0.08	1.92		0.08
8015B-TPH	Combined	>C16-C21 Combined	mg/L	0.19		0.08	0.20		0.08
8015B-TPH	Combined	>C21-C32 Combined	mg/L		U	0.08	0.14		0.08
8015B-TPH	Combined	TPH (C9-C44)	mg/L	4.89		0.08	5.68		0.08
8015B-TPH	Aliphatic	TPH (C9-C44) - F1 Aliphatics	mg/L	0.0380	J	0.08	0.024	J	0.08
8015B-TPH	Aromatic	TPH (C9-C44) - F2 Aromatics	mg/L	2.49		0.08	2.47		0.08
<b>Semi-Quantitative</b>					Q	RL	Result	Q	RL
8270-Full Scan	Additives	2(2-methoxyethoxy)-ethanol	mg/L	0.049		1.0	0.053		1.0
8270-Full Scan	Dispersent	1-butoxy-2-propanol	mg/L	0.000		1.0	0.039		1.0

Experiment Day	Day 10	Day 10
Sample Matrix	WAF	WAF
Fuel	JP-5	JP-5
Fuel to Water Ratio	1:100	1:100
Dispersent	None	Simple Green
Client ID	DAY10-JP-5_2	DAY10-JP-5_2+SG_2
Lab ID	L2317027-13	L2317027-16
Matrix	WATER	WATER
Reference Method	8015D(M)	8015D(M)
Batch ID	WG1767601	WG1763893
Date Collected	4/10/2023	4/10/2023
Date Received	4/10/2023	4/10/2023
Date Prepped	4/17/2023	4/17/2023
Date Analyzed	4/29/2023	4/29/2023
Sample Size(wet)	840	830
% Solid	100	100
File ID	f18042723059	f18042723061

Method	Abbrev	Analytes	Units	Result	Q	RL	Result	Q	RL	
TO-15-Vapor	B	Benzene	µg/m³							
TO-15-Vapor	T	Toluene	µg/m³							
TO-15-Vapor	EB	Ethylbenzene	µg/m³							
TO-15-Vapor	MPX	P/M-Xylene	µg/m³							
TO-15-Vapor	OX	O-Xylene	µg/m³							
TO-15-Vapor	N0	Naphthalene	µg/m³							
TO-15-Vapor	2MN	2-Methylnaphthalene	µg/m³							
TO-15-Vapor	1MN	1-Methylnaphthalene	µg/m³							
TO-15-Vapor	Aliphatic	C5-C8 Aliphatics	µg/m³							
TO-15-Vapor	Aliphatic	C9-C12+ Aliphatics	µg/m³							
TO-15-Vapor	Aromatic	C9-C12+ Aromatics	µg/m³							
PIANO-VOCs	B	Benzene	mg/L	0.0134		0.002	0.0134		0.002	
PIANO-VOCs	T	Toluene	mg/L	0.162		0.002	0.166		0.002	
PIANO-VOCs	EB	Ethylbenzene	mg/L	0.0821		0.002	0.0868		0.002	
PIANO-VOCs	MPX	P/M-Xylene	mg/L	0.382		0.002	0.408		0.002	
PIANO-VOCs	OX	O-Xylene	mg/L	0.253		0.002	0.270		0.002	
PIANO-VOCs	N0	Naphthalene	mg/L	0.616		0.002	0.660		0.002	
PIANO-VOCs	2MN	2-Methylnaphthalene	mg/L	0.322		0.002	0.343		0.002	
PIANO-VOCs	1MN	1-Methylnaphthalene	mg/L	0.236		0.002	0.254		0.002	
PIANO-VOCs	Aliphatic	C5-C6 Aliphatics	mg/L		U	0.002		U	0.002	
PIANO-VOCs	Aliphatic	>C6-C8 Aliphatics	mg/L	0.0069		0.002	0.0067		0.002	
8015B-TPH	Aliphatic	>C8-C10 Aliphatics	mg/L		U	0.08		U	0.08	
8015B-TPH	Aliphatic	>C10-C12 Aliphatics	mg/L		U	0.08		U	0.08	
8015B-TPH	Aliphatic	>C12-C16 Aliphatics	mg/L		U	0.08		U	0.08	
8015B-TPH	Aliphatic	>C16-C21 Aliphatics	mg/L		U	0.08		U	0.08	
8015B-TPH	Aliphatic	>C21-C32 Aliphatics	mg/L		U	0.08		U	0.08	
8015B-TPH	Aromatic	>C8-C10 Aromatics	mg/L	0.78		0.08	0.66		0.08	
8015B-TPH	Aromatic	>C10-C12 Aromatics	mg/L	1.53		0.08	1.26		0.08	
8015B-TPH	Aromatic	>C12-C16 Aromatics	mg/L	1.02		0.08	0.83		0.08	
8015B-TPH	Aromatic	>C16-C21 Aromatics	mg/L		U	0.08		U	0.08	
8015B-TPH	Aromatic	>C21-C32 Aromatics	mg/L		U	0.08		U	0.08	
8015B-TPH	Combined	>C8-C10 Combined	mg/L	1.31		0.08	1.31		0.08	
8015B-TPH	Combined	>C10-C12 Combined	mg/L	2.26		0.08	1.96		0.08	
8015B-TPH	Combined	>C12-C16 Combined	mg/L	2.05		0.08	1.67		0.08	
8015B-TPH	Combined	>C16-C21 Combined	mg/L	0.18		0.08	0.18		0.08	
8015B-TPH	Combined	>C21-C32 Combined	mg/L		U	0.08	0.13		0.08	
8015B-TPH	Combined	TPH (C9-C44)	mg/L	5.58		0.08	5.31		0.08	
8015B-TPH	Aliphatic	TPH (C9-C44) - F1 Aliphatics	mg/L	0.00002	J	0.08	0.00002	J	0.08	
8015B-TPH	Aromatic	TPH (C9-C44) - F2 Aromatics	mg/L	3.07		0.08	2.59		0.08	
<b>Semi-Quantitative</b>					Q	RL		Result	Q	RL
8270-Full Scan	Additives	2(2-methoxyethoxy)-ethanol	mg/L	0.052		1.0	0.059		1.0	
8270-Full Scan	Dispersent	1-butoxy-2-propanol	mg/L	0.000		1.0	0.036		1.0	

	Experiment Day	Day 15	Day 15
Sample Matrix		WAF	WAF
Fuel		JP-5	JP-5
Fuel to Water Ratio		1:100	1:100
Dispersent		None	Simple Green
Client ID		DAY15-JP-5_2	DAY15-JP-5_2+SG_2
Lab ID		L2317027-19	L2317027-22
Matrix		WATER	WATER
Reference Method		8015D(M)	8015D(M)
Batch ID		WG1763893	WG1763893
Date Collected		4/15/2023	4/15/2023
Date Received		4/15/2023	4/15/2023
Date Prepped		4/21/2023	4/21/2023
Date Analyzed		4/28/2023	4/28/2023
Sample Size(wet)		820	860
% Solid		100	100
File ID		f18042723041	f18042723043

Method	Abbrev	Analytes	Units	Result	Q	RL	Result	Q	RL
TO-15-Vapor	B	Benzene	µg/m³						
TO-15-Vapor	T	Toluene	µg/m³						
TO-15-Vapor	EB	Ethylbenzene	µg/m³						
TO-15-Vapor	MPX	P/M-Xylene	µg/m³						
TO-15-Vapor	OX	O-Xylene	µg/m³						
TO-15-Vapor	N0	Naphthalene	µg/m³						
TO-15-Vapor	2MN	2-Methylnaphthalene	µg/m³						
TO-15-Vapor	1MN	1-Methylnaphthalene	µg/m³						
TO-15-Vapor	Aliphatic	C5-C8 Aliphatics	µg/m³						
TO-15-Vapor	Aliphatic	C9-C12+ Aliphatics	µg/m³						
TO-15-Vapor	Aromatic	C9-C12+ Aromatics	µg/m³						
PIANO-VOCs	B	Benzene	mg/L	0.0139		0.002	0.0133		0.002
PIANO-VOCs	T	Toluene	mg/L	0.154		0.002	0.162		0.002
PIANO-VOCs	EB	Ethylbenzene	mg/L	0.079		0.002	0.0853		0.002
PIANO-VOCs	MPX	P/M-Xylene	mg/L	0.373		0.002	0.407		0.002
PIANO-VOCs	OX	O-Xylene	mg/L	0.251		0.002	0.274		0.002
PIANO-VOCs	N0	Naphthalene	mg/L	0.706		0.002	0.725		0.002
PIANO-VOCs	2MN	2-Methylnaphthalene	mg/L	0.371		0.002	0.381		0.002
PIANO-VOCs	1MN	1-Methylnaphthalene	mg/L	0.275		0.002	0.286		0.002
PIANO-VOCs	Aliphatic	C5-C6 Aliphatics	mg/L		U	0.002		U	0.002
PIANO-VOCs	Aliphatic	>C6-C8 Aliphatics	mg/L	0.0062	U	0.002	0.0058	J	0.002
8015B-TPH	Aliphatic	>C8-C10 Aliphatics	mg/L		U	0.081		U	0.077
8015B-TPH	Aliphatic	>C10-C12 Aliphatics	mg/L		U	0.081		U	0.077
8015B-TPH	Aliphatic	>C12-C16 Aliphatics	mg/L		U	0.081		U	0.077
8015B-TPH	Aliphatic	>C16-C21 Aliphatics	mg/L		U	0.081		U	0.077
8015B-TPH	Aliphatic	>C21-C32 Aliphatics	mg/L		U	0.081		U	0.077
8015B-TPH	Aromatic	>C8-C10 Aromatics	mg/L	0.63		0.081	0.74		0.077
8015B-TPH	Aromatic	>C10-C12 Aromatics	mg/L	1.32		0.081	1.52		0.077
8015B-TPH	Aromatic	>C12-C16 Aromatics	mg/L	0.90		0.081	1.15		0.077
8015B-TPH	Aromatic	>C16-C21 Aromatics	mg/L		U	0.081		U	0.077
8015B-TPH	Aromatic	>C21-C32 Aromatics	mg/L		U	0.081		U	0.077
8015B-TPH	Combined	>C8-C10 Combined	mg/L	1.15		0.081	1.27		0.077
8015B-TPH	Combined	>C10-C12 Combined	mg/L	2.07		0.081	2.00		0.077
8015B-TPH	Combined	>C12-C16 Combined	mg/L	1.88		0.081	1.83		0.077
8015B-TPH	Combined	>C16-C21 Combined	mg/L	0.17		0.081	0.18		0.077
8015B-TPH	Combined	>C21-C32 Combined	mg/L		U	0.081	0.10		0.077
8015B-TPH	Combined	TPH (C9-C44)	mg/L	5.31		0.081	5.14		0.077
8015B-TPH	Aliphatic	TPH (C9-C44) - F1 Aliphatics	mg/L	0.01	J	0.081	0.01	J	0.077
8015B-TPH	Aromatic	TPH (C9-C44) - F2 Aromatics	mg/L	2.75		0.081	3.06		0.077
<b>Semi-Quantitative</b>					Q	RL	Result	Q	RL
8270-Full Scan	Additives	2(2-methoxyethoxy)-ethanol	mg/L	0.053		1.0	0.047		1.0
8270-Full Scan	Dispersent	1-butoxy-2-propanol	mg/L	0.000		1.0	0.039		1.0

Experiment Day	Day 20	Day 20
Sample Matrix	WAF	WAF
Fuel	JP-5	JP-5
Fuel to Water Ratio	1:100	1:100
Dispersent	None	Simple Green
Client ID	DAY20-JP-5_2	DAY20-JP-5_2+SG_2
Lab ID	L2317027-25	L2317027-28
Matrix	WATER	WATER
Reference Method	8015D(M)	8015D(M)
Batch ID	WG1763893	WG1767601
Date Collected	4/20/2023	4/20/2023
Date Received	4/20/2023	4/20/2023
Date Prepped	4/26/2023	4/26/2023
Date Analyzed	4/28/2023	4/28/2023
Sample Size(wet)	830	830
% Solid	100	100
File ID	f18042723053	f18042723055

Method	Abbrev	Analytes	Units	Result	Q	RL	Result	Q	RL
TO-15-Vapor	B	Benzene	µg/m³	1,610		319	2,190		319
TO-15-Vapor	T	Toluene	µg/m³	22,600		377	29,700		377
TO-15-Vapor	EB	Ethylbenzene	µg/m³	16,700		434	21,200		434
TO-15-Vapor	MPX	P/M-Xylene	µg/m³	62,100		869	78,200		869
TO-15-Vapor	OX	O-Xylene	µg/m³	29,500		434	37,500		434
TO-15-Vapor	N0	Naphthalene	µg/m³	3,850		524	5,560		524
TO-15-Vapor	2MN	2-Methylnaphthalene	µg/m³	1,745		524	3,402		524
TO-15-Vapor	1MN	1-Methylnaphthalene	µg/m³	2,821		524	5,467		524
TO-15-Vapor	Aliphatic	C5-C8 Aliphatics	µg/m³	1,887,957		352	2,194,998		352
TO-15-Vapor	Aliphatic	C9-C12+ Aliphatics	µg/m³	6,679,692		352	8,041,379		352
TO-15-Vapor	Aromatic	C9-C12+ Aromatics	µg/m³	347,868		434	456,854		434
PIANO-VOCs	B	Benzene	mg/L	0.0108		0.002	0.0128		0.002
PIANO-VOCs	T	Toluene	mg/L	0.143		0.002	0.160		0.002
PIANO-VOCs	EB	Ethylbenzene	mg/L	0.0782		0.002	0.0848		0.002
PIANO-VOCs	MPX	P/M-Xylene	mg/L	0.380		0.002	0.404		0.002
PIANO-VOCs	OX	O-Xylene	mg/L	0.253		0.002	0.271		0.002
PIANO-VOCs	N0	Naphthalene	mg/L	0.662		0.002	0.693		0.002
PIANO-VOCs	2MN	2-Methylnaphthalene	mg/L	0.345		0.002	0.360		0.002
PIANO-VOCs	1MN	1-Methylnaphthalene	mg/L	0.257		0.002	0.269		0.002
PIANO-VOCs	Aliphatic	C5-C6 Aliphatics	mg/L		U	0.002		U	0.002
PIANO-VOCs	Aliphatic	>C6-C8 Aliphatics	mg/L	0.0054	U	0.002	0.0059	U	0.002
8015B-TPH	Aliphatic	>C8-C10 Aliphatics	mg/L		U	0.08		U	0.08
8015B-TPH	Aliphatic	>C10-C12 Aliphatics	mg/L		U	0.08		U	0.08
8015B-TPH	Aliphatic	>C12-C16 Aliphatics	mg/L		U	0.08		U	0.08
8015B-TPH	Aliphatic	>C16-C21 Aliphatics	mg/L		U	0.08		U	0.08
8015B-TPH	Aliphatic	>C21-C32 Aliphatics	mg/L		U	0.08		U	0.08
8015B-TPH	Aromatic	>C8-C10 Aromatics	mg/L	0.83		0.08	0.83		0.08
8015B-TPH	Aromatic	>C10-C12 Aromatics	mg/L	1.59		0.08	1.58		0.08
8015B-TPH	Aromatic	>C12-C16 Aromatics	mg/L	1.05		0.08	1.00		0.08
8015B-TPH	Aromatic	>C16-C21 Aromatics	mg/L		U	0.08		U	0.08
8015B-TPH	Aromatic	>C21-C32 Aromatics	mg/L		U	0.08		U	0.08
8015B-TPH	Combined	>C8-C10 Combined	mg/L	1.26		0.08	1.47		0.08
8015B-TPH	Combined	>C10-C12 Combined	mg/L	2.19		0.08	2.23		0.08
8015B-TPH	Combined	>C12-C16 Combined	mg/L	1.82		0.08	1.96		0.08
8015B-TPH	Combined	>C16-C21 Combined	mg/L	0.15		0.08	0.19		0.08
8015B-TPH	Combined	>C21-C32 Combined	mg/L			0.08	0.13		0.08
8015B-TPH	Combined	TPH (C9-C44)	mg/L	5.26		0.08	5.93		0.08
8015B-TPH	Aliphatic	TPH (C9-C44) - F1 Aliphatics	mg/L	0.004	J	0.08	-	J	0.08
8015B-TPH	Aromatic	TPH (C9-C44) - F2 Aromatics	mg/L	3.33		0.08	3.32		0.08
<b>Semi-Quantitative</b>					Q	RL	Result	Q	RL
8270-Full Scan	Additives	2(2-methoxyethoxy)-ethanol	mg/L	Not Tested		1.0	0.053		1.0
8270-Full Scan	Dispersent	1-butoxy-2-propanol	mg/L	Not Tested		1.0	0.041		1.0

# EPA Method 8015: Detailed Quant Reports Aliphatic and Aromatic Carbon Ranges



Data Path : C:\Projects\Hawaii DOH\2. Laboratory Data\Alpha\WAF Study\L2259785 (JP5)\TPH\NF TPH\  
 Data File : f18021023020.D  
 Signal(s) : FID1A.ch  
 Acq On : 10 Feb 2023 11:48 pm  
 Operator : FID18:WR  
 Sample : L2259785-01,42,,  
 Misc : WG1743197,WG1742147,ICAL19428  
 ALS Vial : 10 Sample Multiplier: 1

Integration File: SHCINT2.E  
 Quant Time: Jun 01 14:34:12 2023  
 Quant Method : C:\Projects\Hawaii DOH\2. Laboratory Data\Alpha\HDOH Red Hill (TetraTech Hi sharin  
 .. g files)\L2259785 (JP5)\TPH\NF TPH\NF TPH Quant.M  
 Quant Title : FID Forensics  
 QLast Update : Fri Sep 23 15:53:13 2022  
 Response via : Initial Calibration  
 Integrator: ChemStation

Volume Inj. : 1.0  
 Signal Phase : Rtx-5MS  
 Signal Info : 0.25mm

Blank Name : IB1802102301F  
 Blank File : f18021023010.D

Compound	R.T.	Response	Conc Units
Internal Standards			
1) I 5-alpha-androstane	30.347	61164251	50.000 ug/mL m
System Monitoring Compounds			
2) s ortho-terphenyl	28.394f	60664551	47.444 ug/mL m
Spiked Amount 50.000	Range 50 - 130	Recovery =	94.89%
3) s d50-Tetracosane	35.015	51106372	50.549 ug/mL m
Spiked Amount 50.000	Range 50 - 130	Recovery =	101.10%
Target Compounds			
4) h > C8 to C10 Aliphatics	7.522	467271923	405.494 ug/mL m
5) h > C10 to C12 Aliphatics	12.357	2278780393	1977.506 ug/ml m
6) h > C12 to C16 Aliphatics	16.698	2608351179	2263.504 UG/ML m
7) h > C16 to C21 Aliphatics	28.312	103439320	89.764 UG/ML m
8) h > C21 to C32 Aliphatics	32.821	10641436	9.235 UG/ML m

SemiQuant Compounds - Not Calibrated on this Instrument

(f)=RT Delta > 1/2 Window

(m)=manual int.

Data Path : C:\Projects\Hawaii DOH\2. Laboratory Data\Alpha\WAF Study\L2259785 (JP5)\TPH\NF TPH\  
Data File : f18021023020.D  
Signal(s) : FID1A.ch  
Acq On : 10 Feb 2023 11:48 pm  
Operator : FID18:WR  
Sample : 12259785-01,42,,  
Misc : WG1743197,WG1742147,ICAL19428  
ALS Vial : 10 Sample Multiplier: 1

Integration File: SHCINT2.E  
Quant Time: Jun 01 14:34:12 2023  
Quant Method : C:\Projects\Hawaii DOH\2. Laboratory Data\Alpha\HDOH Red Hill (TetraTech Hi sharin  
g files)\L2259785 (JP5)\TPH\NF TPH\NF TPH Quant.M  
Quant Title : FID Forensics  
QLast Update : Fri Sep 23 15:53:13 2022  
Response via : Initial Calibration  
Integrator: ChemStation

Volume Inj. : 1.0  
Signal Phase : Rtx-5MS  
Signal Info : 0.25mm

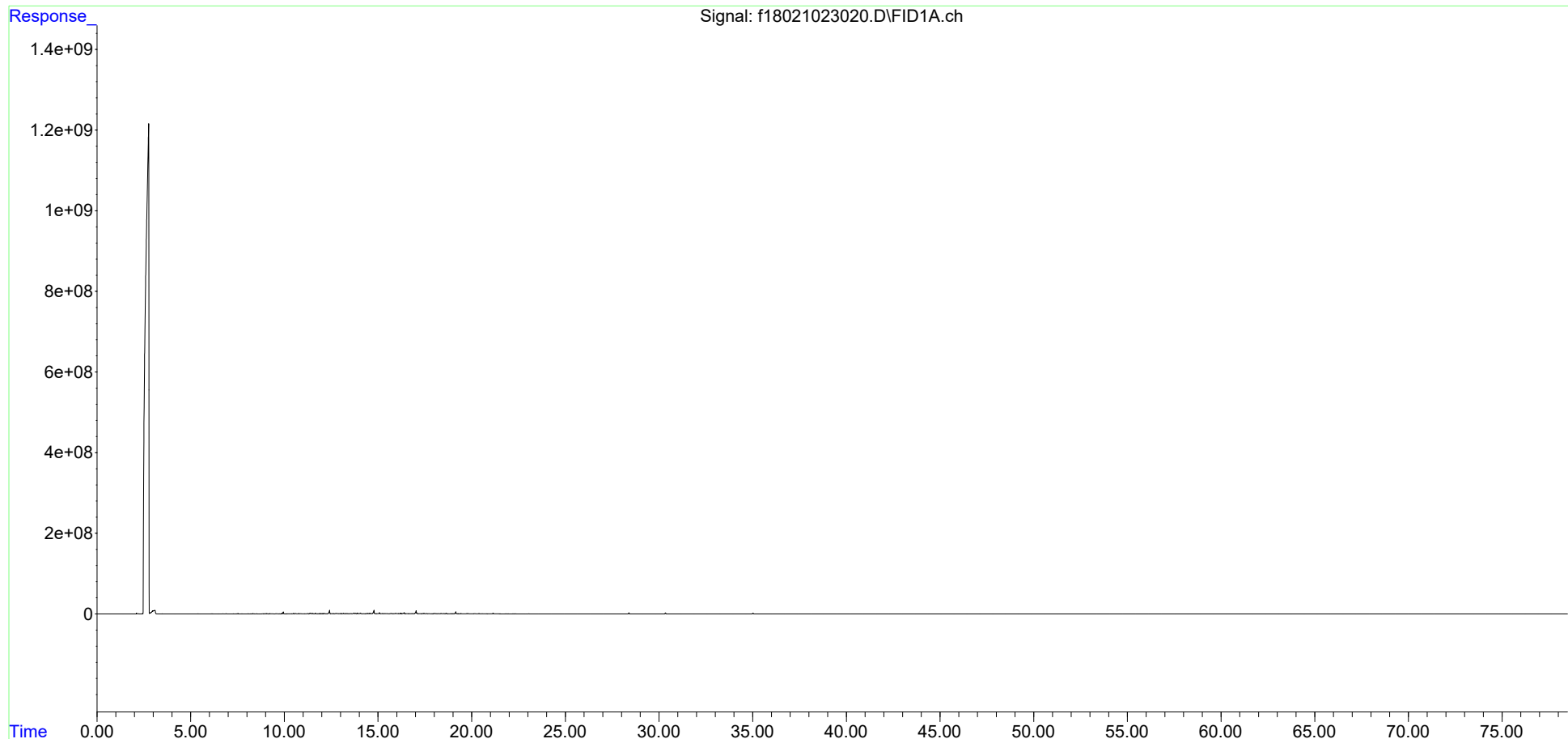

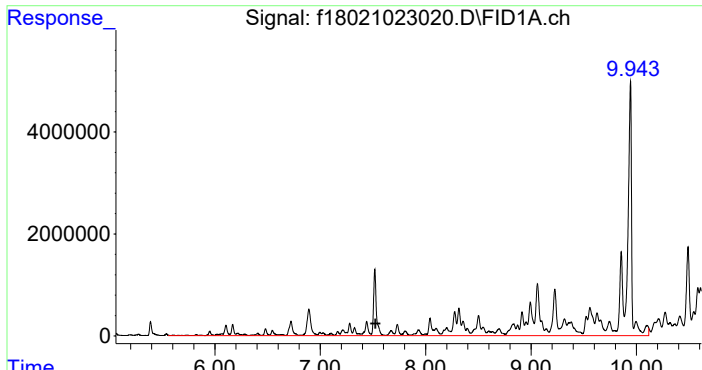

#4 > C8 to C10 Aliphatics  
 R.T.: 7.522 min  
 Delta R.T.: 0.000 min  
 Response: 467271923  
 Conc: 405.49 ug/mL m

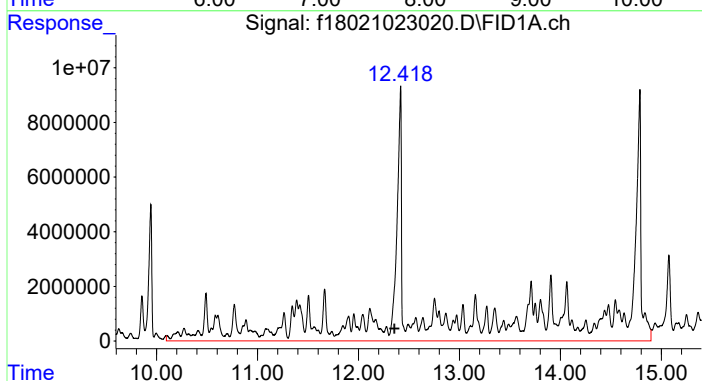

#5 > C10 to C12 Aliphatics  
 R.T.: 12.357 min  
 Delta R.T.: 0.000 min  
 Response: 2278780393  
 Conc: 1977.51 ug/ml m

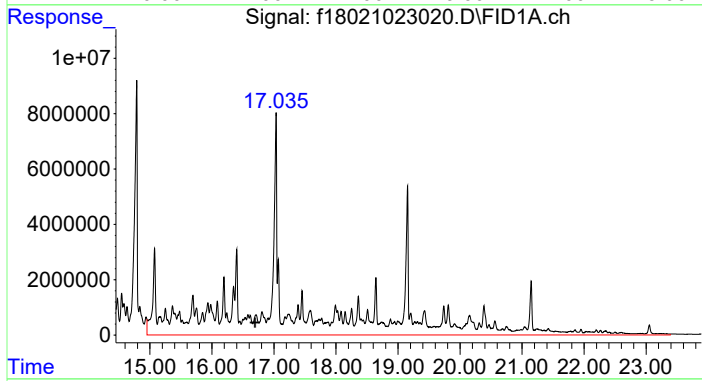

#6 > C12 to C16 Aliphatics  
 R.T.: 16.698 min  
 Delta R.T.: 0.000 min  
 Response: 2608351179  
 Conc: 2263.50 UG/ML m

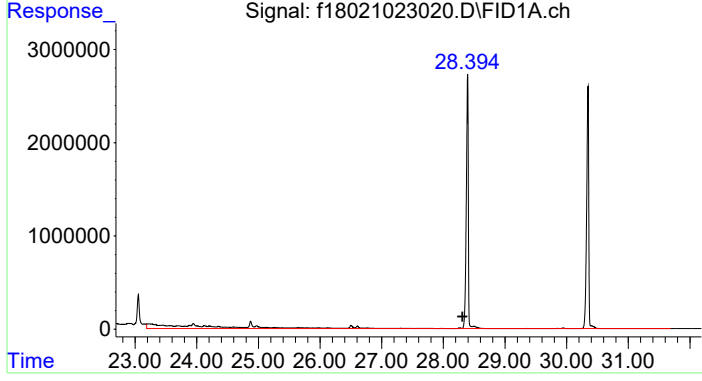

#7 > C16 to C21 Aliphatics  
 R.T.: 28.312 min  
 Delta R.T.: 0.000 min  
 Response: 103439320  
 Conc: 89.76 UG/ML m

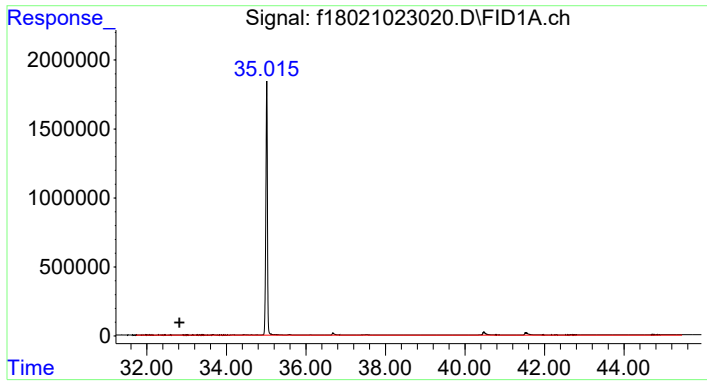

#8 > C21 to C32 Aliphatics

R.T.: 32.821 min  
Delta R.T.: 0.000 min  
Response: 10641436  
Conc: 9.23 UG/ML m

Data Path : C:\Projects\Hawaii DOH\2. Laboratory Data\Alpha\WAF Study\L2259785 (JP5)\TPH\NF TPH\  
 Data File : f18021023048.D  
 Signal(s) : FID1A.ch  
 Acq On : 11 Feb 2023 07:54 pm  
 Operator : FID18:WR  
 Sample : L2259785-02F1,42,,  
 Misc : WG1743197,WG1742591,ICAL19428  
 ALS Vial : 24 Sample Multiplier: 1

Integration File: SHCINT2.E  
 Quant Time: Jun 01 14:30:31 2023  
 Quant Method : C:\Projects\Hawaii DOH\2. Laboratory Data\Alpha\HDOH Red Hill (TetraTech Hi sharin  
 .. g files)\L2259785 (JP5)\TPH\NF TPH\NF TPH Quant.M  
 Quant Title : FID Forensics  
 QLast Update : Fri Sep 23 15:53:13 2022  
 Response via : Initial Calibration  
 Integrator: ChemStation

Volume Inj. : 1.0  
 Signal Phase : Rtx-5MS  
 Signal Info : 0.25mm

Blank Name : IB1802102302F  
 Blank File : f18021023028.D

Compound	R.T.	Response	Conc Units
Internal Standards			
1) I 5-alpha-androstane	30.360	75109634	50.000 ug/mL m
System Monitoring Compounds			
3) s d50-Tetracosane	35.025	61080160	49.197 ug/mL m
Spiked Amount 50.000	Range 50 - 130	Recovery =	98.39%
Target Compounds			
4) h > C8 to C10 Aliphatics	7.522	1490458085	1053.264 ug/mL m
5) h > C10 to C12 Aliphatics	12.357	8951127762	6325.503 ug/ml m
6) h > C12 to C16 Aliphatics	16.698	11731527962	8290.331 UG/ML m
7) h > C16 to C21 Aliphatics	28.312	183694210	129.811 UG/ML m
8) h > C21 to C32 Aliphatics	32.821	15352181	10.849 UG/ML m

SemiQuant Compounds - Not Calibrated on this Instrument

(f)=RT Delta > 1/2 Window

(m)=manual int.

Data Path : C:\Projects\Hawaii DOH\2. Laboratory Data\Alpha\WAF Study\L2259785 (JP5)\TPH\NF TPH\  
Data File : f18021023048.D  
Signal(s) : FID1A.ch  
Acq On : 11 Feb 2023 07:54 pm  
Operator : FID18:WR  
Sample : 12259785-02F1,42,,  
Misc : WG1743197,WG1742591,ICAL19428  
ALS Vial : 24 Sample Multiplier: 1

Integration File: SHCINT2.E  
Quant Time: Jun 01 14:30:31 2023  
Quant Method : C:\Projects\Hawaii DOH\2. Laboratory Data\Alpha\HDOH Red Hill (TetraTech Hi sharin  
g files)\L2259785 (JP5)\TPH\NF TPH\NF TPH Quant.M  
Quant Title : FID Forensics  
QLast Update : Fri Sep 23 15:53:13 2022  
Response via : Initial Calibration  
Integrator: ChemStation

Volume Inj. : 1.0  
Signal Phase : Rtx-5MS  
Signal Info : 0.25mm

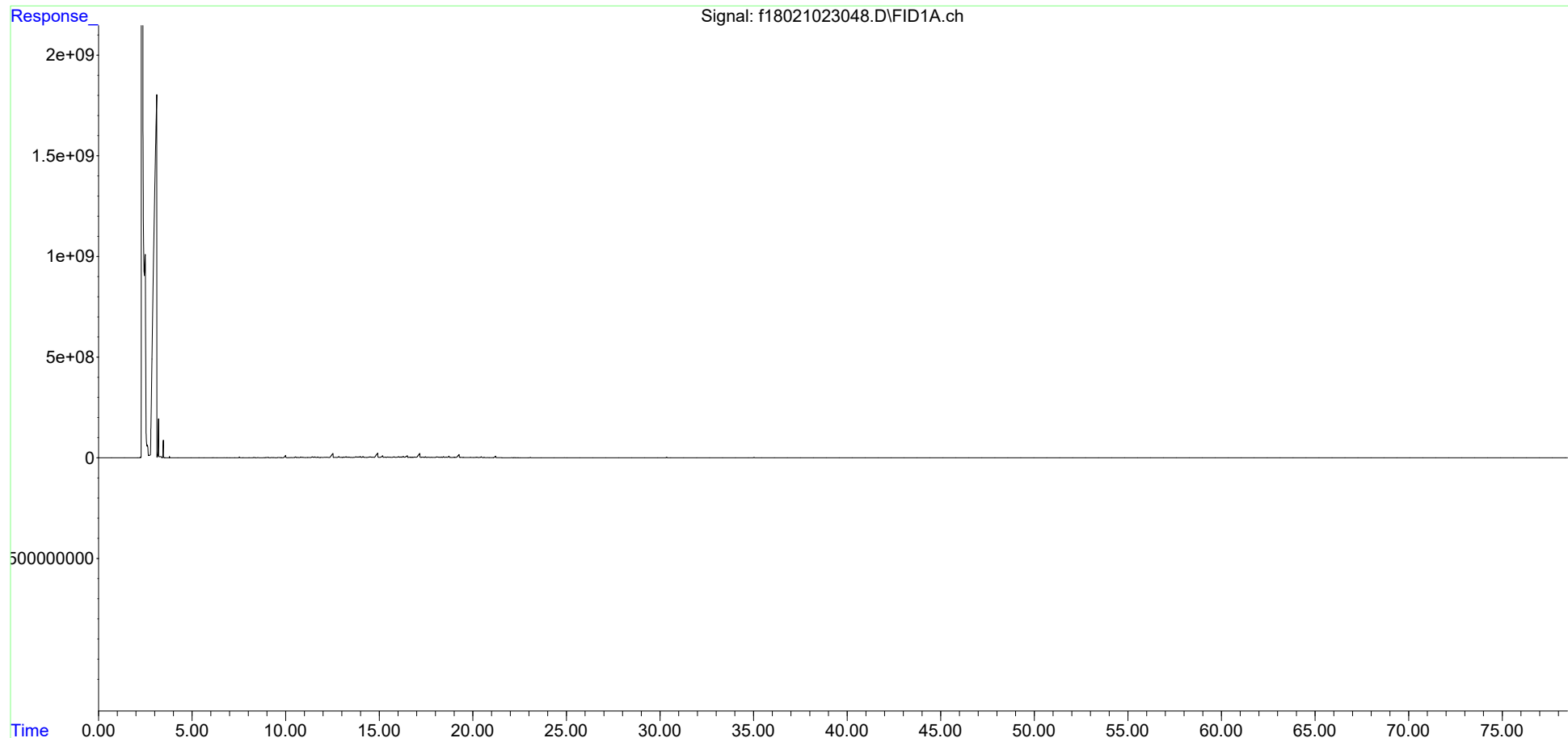

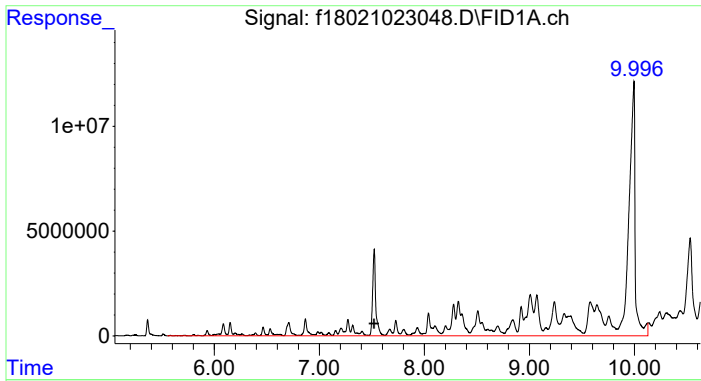

#4 > C8 to C10 Aliphatics  
 R.T.: 7.522 min  
 Delta R.T.: 0.000 min  
 Response: 1490458085  
 Conc: 1053.26 ug/mL m

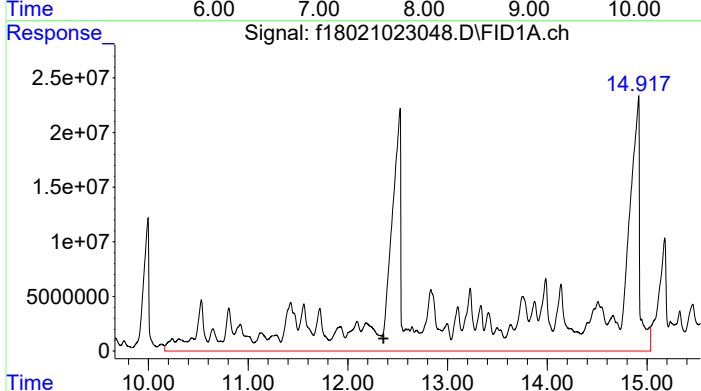

#5 > C10 to C12 Aliphatics  
 R.T.: 12.357 min  
 Delta R.T.: 0.000 min  
 Response: 8951127762  
 Conc: 6325.50 ug/ml m

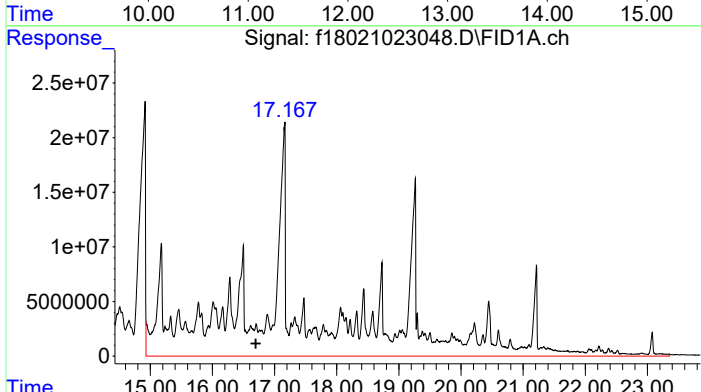

#6 > C12 to C16 Aliphatics  
 R.T.: 16.698 min  
 Delta R.T.: 0.000 min  
 Response: 11731527962  
 Conc: 8290.33 UG/ML m

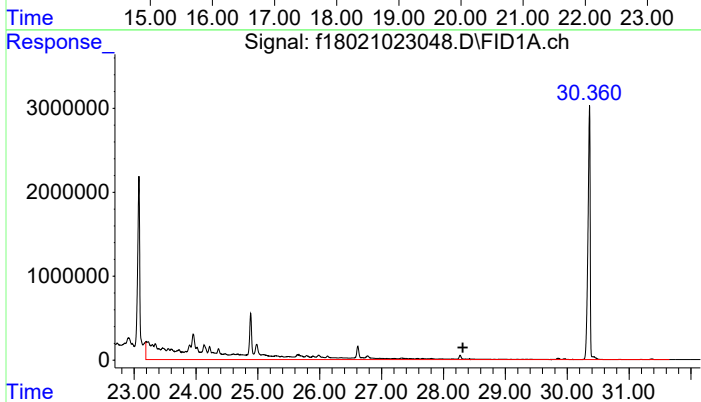

#7 > C16 to C21 Aliphatics  
 R.T.: 28.312 min  
 Delta R.T.: 0.000 min  
 Response: 183694210  
 Conc: 129.81 UG/ML m

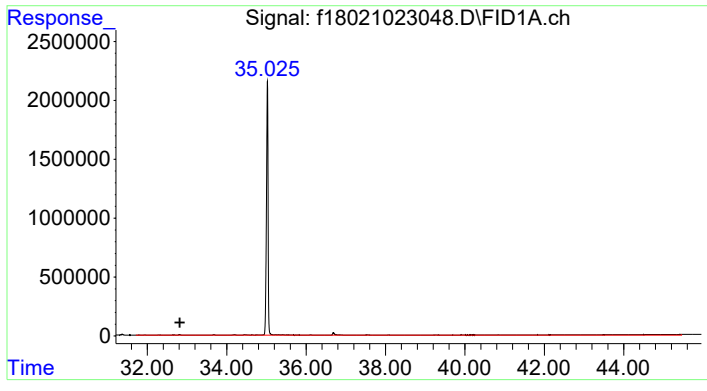

#8 > C21 to C32 Aliphatics

R.T.: 32.821 min  
Delta R.T.: 0.000 min  
Response: 15352181  
Conc: 10.85 UG/ML m



Data Path : C:\Projects\Hawaii DOH\2. Laboratory Data\Alpha\WAF Study\L2259785 (JP5)\TPH\NF TPH\  
 Data File : f18021023042.D  
 Signal(s) : FID1A.ch  
 Acq On : 11 Feb 2023 03:36 pm  
 Operator : FID18:WR  
 Sample : 12259785-03F2,42,,  
 Misc : WG1743197,WG1742592,ICAL19428  
 ALS Vial : 21 Sample Multiplier: 1

Integration File: SHCINT2.E  
 Quant Time: Jun 01 14:20:55 2023  
 Quant Method : C:\Projects\Hawaii DOH\2. Laboratory Data\Alpha\HDOH Red Hill (TetraTech Hi sharin  
 .. g files)\L2259785 (JP5)\TPH\NF TPH\NF TPH Quant.M  
 Quant Title : FID Forensics  
 QLast Update : Fri Sep 23 15:53:13 2022  
 Response via : Initial Calibration  
 Integrator: ChemStation

Volume Inj. : 1.0  
 Signal Phase : Rtx-5MS  
 Signal Info : 0.25mm

Blank Name : IB1802102302F  
 Blank File : f18021023028.D

Compound	R.T.	Response	Conc Units
-----			
Internal Standards			
1) I 5-alpha-androstane	30.355	63922670	50.000 ug/mL m
System Monitoring Compounds			
2) s ortho-terphenyl	28.402f	61210651	45.805 ug/mL m
Spiked Amount 50.000	Range 50 - 130	Recovery =	91.61%
Target Compounds			
9) h > C8 to C10 Aromatics	7.522	241016824	200.127 UG/ML m
10) h > C10 to C12 Aromatics	11.985	1385147094	1150.149 UG/ML m
11) h > C12 to C16 Aromatics	16.698	2502820449	2078.202 UG/ML m
12) h > C16 to C21 Aromatics	28.312	55804718	46.337 UG/ML m
13) h > C21 to C32 Aromatics	32.821	11412715	9.476 UG/ML m

SemiQuant Compounds - Not Calibrated on this Instrument

(f)=RT Delta > 1/2 Window

(m)=manual int.

Data Path : C:\Projects\Hawaii DOH\2. Laboratory Data\Alpha\WAF Study\L2259785 (JP5)\TPH\NF TPH\  
Data File : f18021023042.D  
Signal(s) : FID1A.ch  
Acq On : 11 Feb 2023 03:36 pm  
Operator : FID18:WR  
Sample : 12259785-03F2,42,,  
Misc : WG1743197,WG1742592,ICAL19428  
ALS Vial : 21 Sample Multiplier: 1

Integration File: SHCINT2.E  
Quant Time: Jun 01 14:20:55 2023  
Quant Method : C:\Projects\Hawaii DOH\2. Laboratory Data\Alpha\HDOH Red Hill (TetraTech Hi sharin  
g files)\L2259785 (JP5)\TPH\NF TPH\NF TPH Quant.M  
Quant Title : FID Forensics  
QLast Update : Fri Sep 23 15:53:13 2022  
Response via : Initial Calibration  
Integrator: ChemStation

Volume Inj. : 1.0  
Signal Phase : Rtx-5MS  
Signal Info : 0.25mm

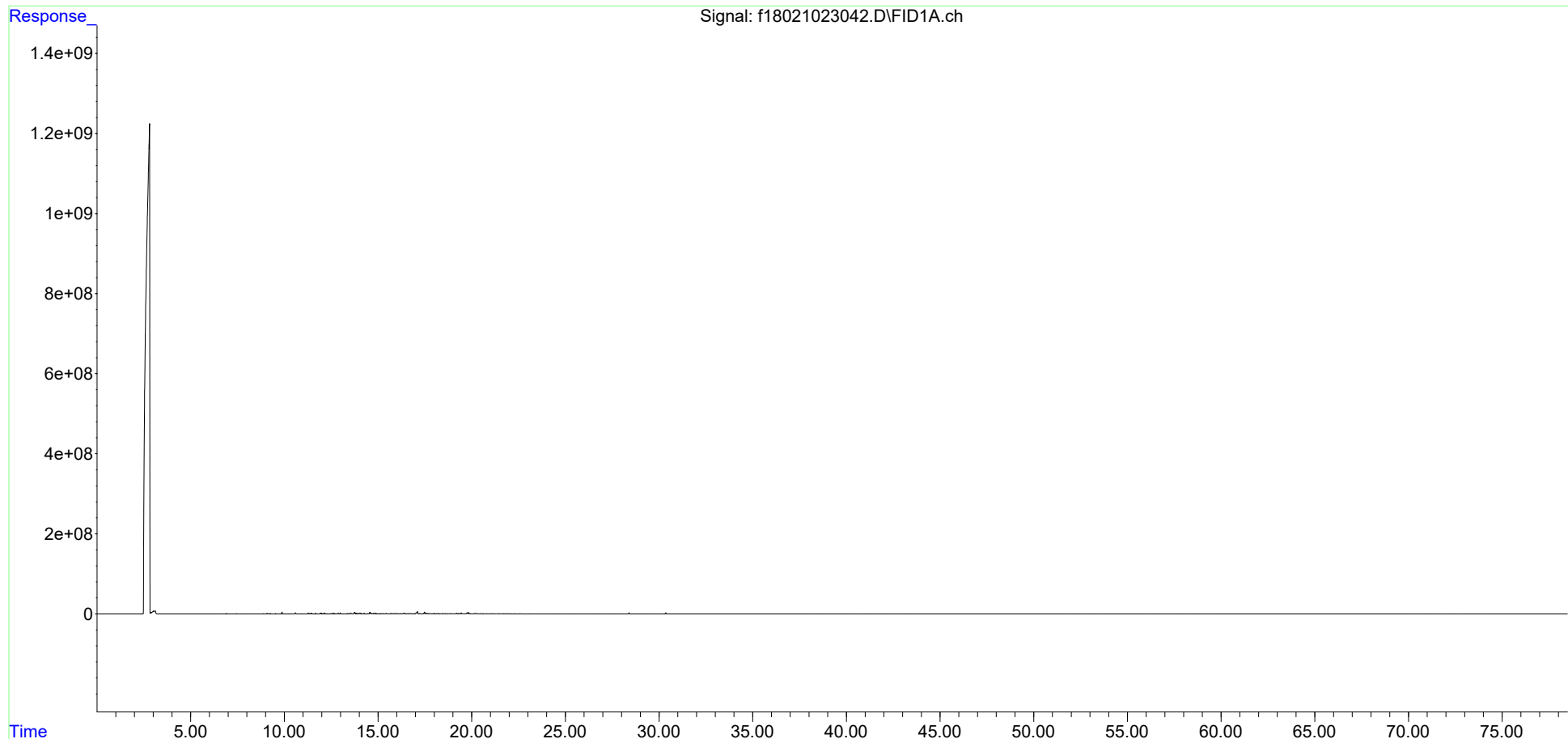

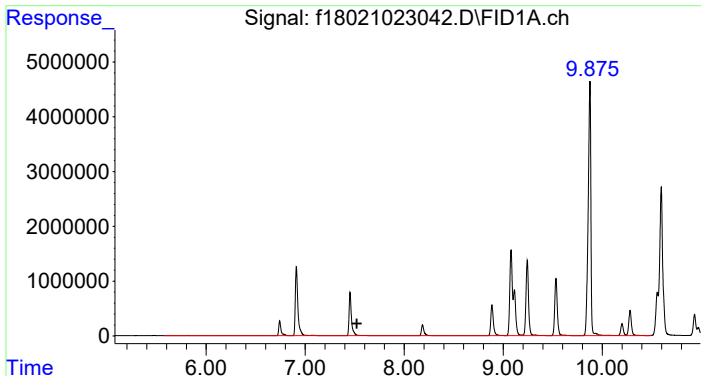

#9 > C8 to C10 Aromatics  
 R.T.: 7.522 min  
 Delta R.T.: 0.000 min  
 Response: 241016824  
 Conc: 200.13 UG/ML m

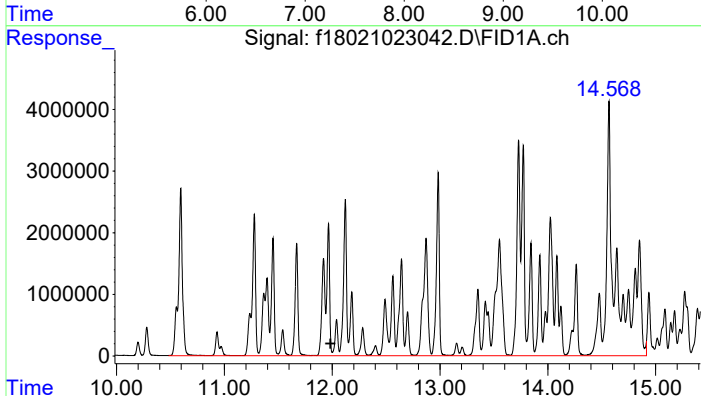

#10 > C10 to C12 Aromatics  
 R.T.: 11.985 min  
 Delta R.T.: 0.000 min  
 Response: 1385147094  
 Conc: 1150.15 UG/ML m

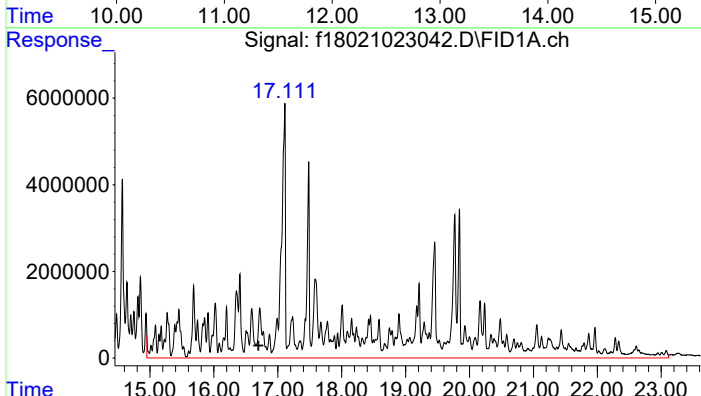

#11 > C12 to C16 Aromatics  
 R.T.: 16.698 min  
 Delta R.T.: 0.000 min  
 Response: 2502820449  
 Conc: 2078.20 UG/ML m

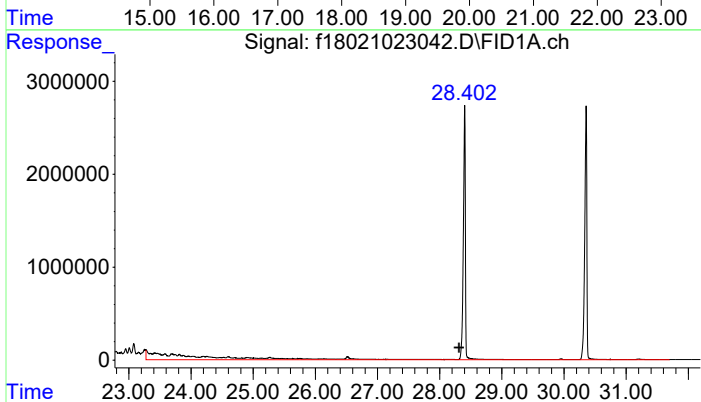

#12 > C16 to C21 Aromatics  
 R.T.: 28.312 min  
 Delta R.T.: 0.000 min  
 Response: 55804718  
 Conc: 46.34 UG/ML m

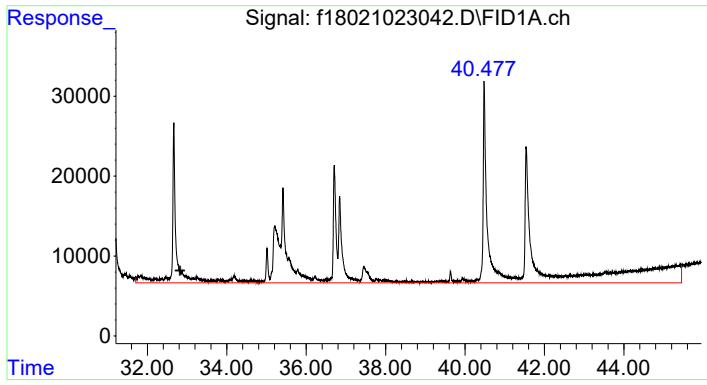

#13 > C21 to C32 Aromatics

R.T.: 32.821 min  
Delta R.T.: 0.000 min  
Response: 11412715  
Conc: 9.48 UG/ML m

Data Path : C:\Projects\Hawaii DOH\2. Laboratory Data\Alpha\WAF Study\L2317027\TPH\NF TPH\  
 Data File : f18042723045.D  
 Signal(s) : FID2B.ch  
 Acq On : 28 Apr 2023 04:35 pm  
 Operator : FID18:AMV  
 Sample : L2317027-01  
 Misc : WG1772069,WG1763893,ICAL19877  
 ALS Vial : 73 Sample Multiplier: 1

Integration File: SHCINT2.E  
 Quant Time: May 31 21:36:04 2023  
 Quant Method : C:\Projects\Hawaii DOH\2. Laboratory Data\Alpha\WAF Study\L2317027\TPH\NF TPH\NF T  
 .. PH Quant.M  
 Quant Title : FID Forensics  
 QLast Update : Fri Sep 23 15:53:13 2022  
 Response via : Initial Calibration  
 Integrator: ChemStation

Volume Inj. : 1.0  
 Signal Phase : Rtx-5MS  
 Signal Info : 0.25mm

Blank Name : IB1804272302R  
 Blank File : f18042723039.D

Compound	R.T.	Response	Conc Units
-----			
Internal Standards			
1) I 5-alpha-androstane	31.069	65901289	50.000 ug/mL m
System Monitoring Compounds			
2) s ortho-terphenyl	29.094	154326450	112.018 ug/mL m
Spiked Amount 50.000	Range 50 - 130	Recovery = 224.04%#	
3) s d50-Tetracosane	35.721	129142186	118.552 ug/mL m
Spiked Amount 50.000	Range 50 - 130	Recovery = 237.10%#	
Target Compounds			
4) h > C8 to C10 Aliphatics	8.012	129955340	104.668 ug/mL m
5) h > C10 to C12 Aliphatics	12.930	194922213	156.993 ug/ml m
6) h > C12 to C16 Aliphatics	23.659	265205519	213.600 UG/ML m
7) h > C16 to C21 Aliphatics	28.995	67520530	54.382 UG/ML m
8) h > C21 to C32 Aliphatics	33.402	23854268	19.213 UG/ML m

SemiQuant Compounds - Not Calibrated on this Instrument

(f)=RT Delta > 1/2 Window

(m)=manual int.

Data Path : C:\Projects\Hawaii DOH\2. Laboratory Data\Alpha\WAF Study\L2317027\TPH\NF TPH\  
Data File : f18042723045.D  
Signal(s) : FID2B.ch  
Acq On : 28 Apr 2023 04:35 pm  
Operator : FID18:AMV  
Sample : L2317027-01  
Misc : WG1772069,WG1763893,ICAL19877  
ALS Vial : 73 Sample Multiplier: 1

Integration File: SHCINT2.E  
Quant Time: May 31 21:36:04 2023  
Quant Method : C:\Projects\Hawaii DOH\2. Laboratory Data\Alpha\WAF Study\L2317027\TPH\NF TPH\NF T  
... PH Quant.M  
Quant Title : FID Forensics  
QLast Update : Fri Sep 23 15:53:13 2022  
Response via : Initial Calibration  
Integrator: ChemStation

Volume Inj. : 1.0  
Signal Phase : Rtx-5MS  
Signal Info : 0.25mm

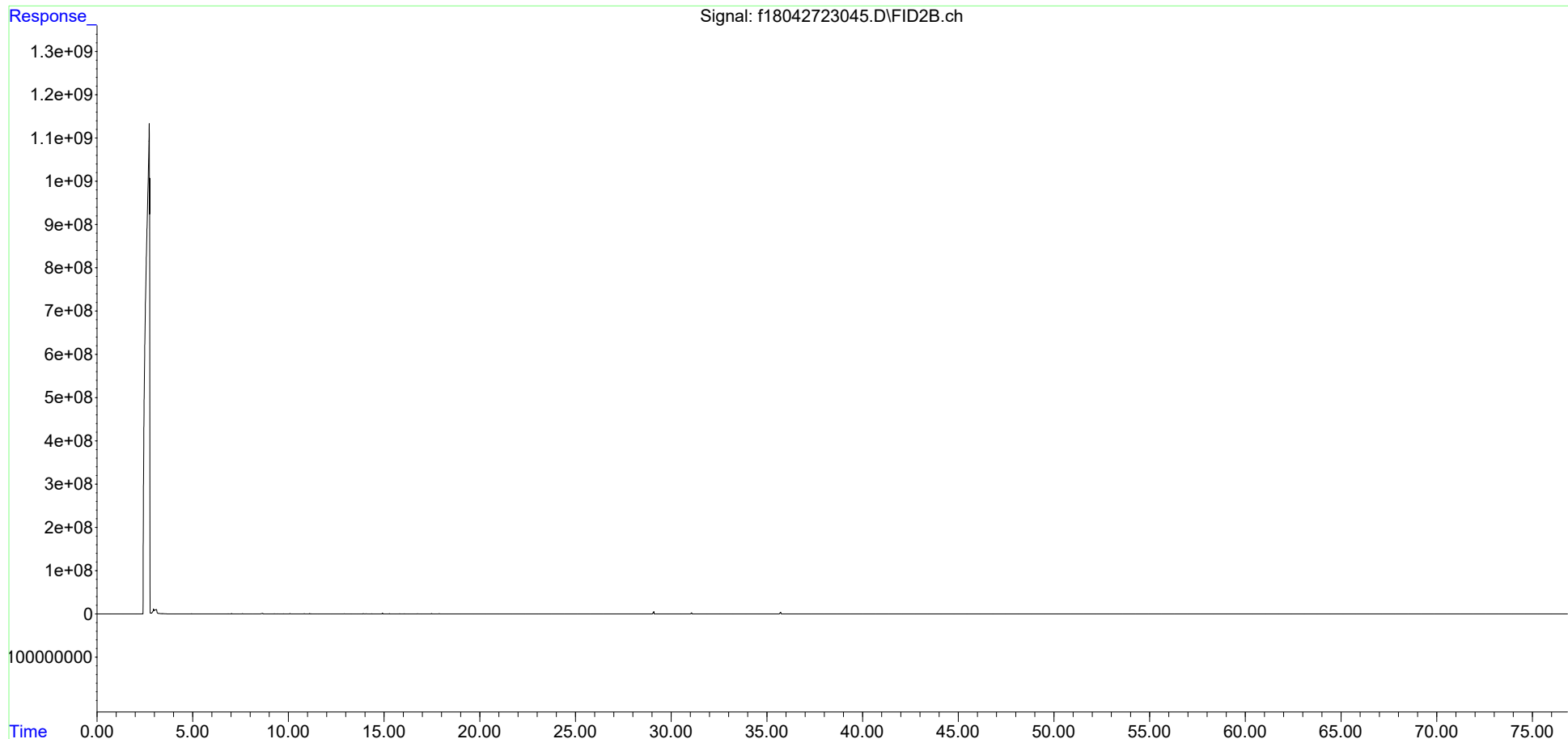

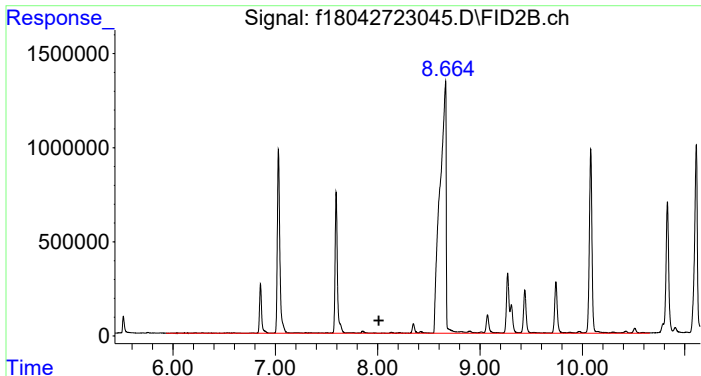

#4 > C8 to C10 Aliphatics

R.T.: 8.012 min  
 Delta R.T.: 0.000 min  
 Response: 129955340  
 Conc: 104.67 ug/mL m

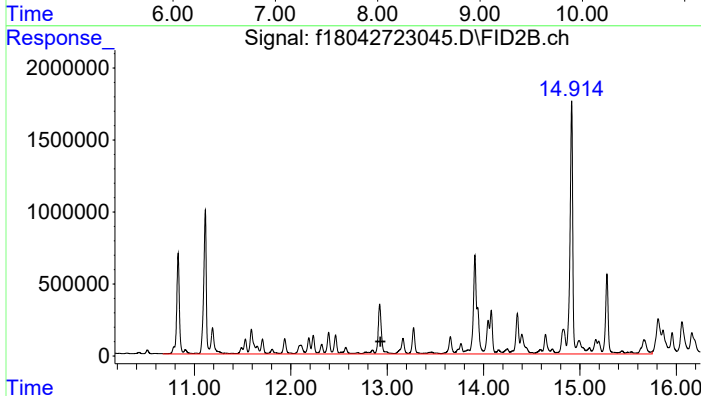

#5 > C10 to C12 Aliphatics

R.T.: 12.930 min  
 Delta R.T.: 0.000 min  
 Response: 194922213  
 Conc: 156.99 ug/ml m

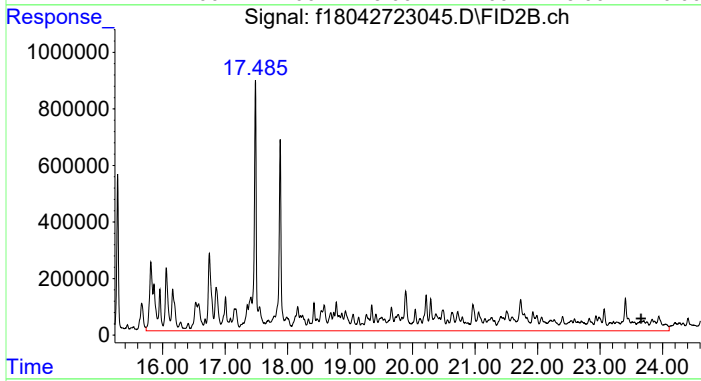

#6 > C12 to C16 Aliphatics

R.T.: 23.659 min  
 Delta R.T.: 0.000 min  
 Response: 265205519  
 Conc: 213.60 UG/ML m

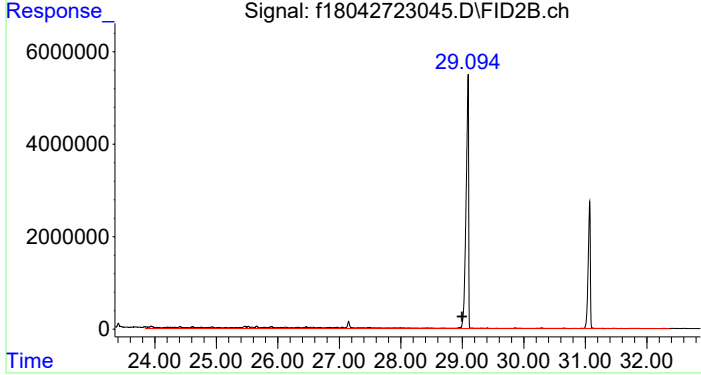

#7 > C16 to C21 Aliphatics

R.T.: 28.995 min  
 Delta R.T.: 0.000 min  
 Response: 67520530  
 Conc: 54.38 UG/ML m

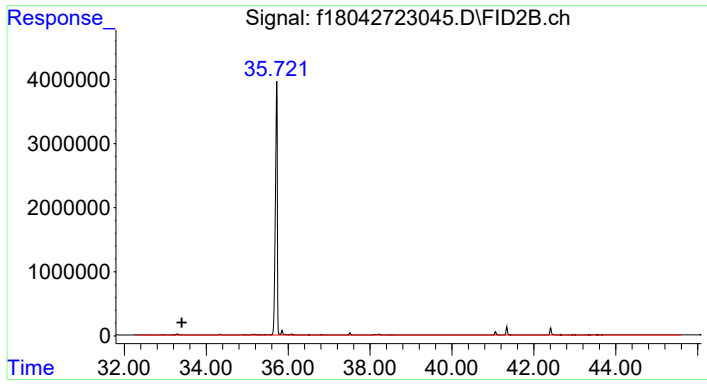

#8 > C21 to C32 Aliphatics

R.T.: 33.402 min  
Delta R.T.: 0.000 min  
Response: 23854268  
Conc: 19.21 UG/ML m



Data Path : C:\Projects\Hawaii DOH\2. Laboratory Data\Alpha\WAF Study\L2317027\TPH\NF TPH\  
 Data File : f18050523073.D  
 Signal(s) : FID2B.ch  
 Acq On : 07 May 2023 01:26 pm  
 Operator : FID18:AMV  
 Sample : L2317027-02F1  
 Misc : WG1775373,WG1771478,ICAL19877  
 ALS Vial : 87 Sample Multiplier: 1

Integration File: SHCINT2.E  
 Quant Time: May 31 15:50:25 2023  
 Quant Method : C:\Projects\Hawaii DOH\2. Laboratory Data\Alpha\WAF Study\L2317027\TPH\NF TPH\NF T  
 .. PH Quant.M  
 Quant Title : FID Forensics  
 QLast Update : Wed May 31 12:22:23 2023  
 Response via : Initial Calibration  
 Integrator: ChemStation

Volume Inj. : 1.0  
 Signal Phase : Rtx-5MS  
 Signal Info : 0.25mm

Blank Name : IB1805052303R  
 Blank File : f18050523061.D

Compound	R.T.	Response	Conc Units
-----			
Internal Standards			
1) I 5-alpha-androstane	30.945	69495745	50.000 ug/mL m
System Monitoring Compounds			
3) s d50-Tetracosane	35.608	131404180	114.390 ug/mL m
Spiked Amount 50.000	Range 50 - 130	Recovery	= 228.78%#
Target Compounds			
4) h > C8 to C10 Aliphatics	8.012	13020377	9.944 ug/mL m
5) h > C10 to C12 Aliphatics	12.930	2082749	1.591 ug/ml m
6) h > C12 to C16 Aliphatics	23.659	2093023	1.599 UG/ML
7) h > C16 to C21 Aliphatics	28.995	2412966	1.843 UG/ML m
8) h > C21 to C32 Aliphatics	33.402	17430404	13.313 UG/ML m

SemiQuant Compounds - Not Calibrated on this Instrument

(f)=RT Delta > 1/2 Window

(m)=manual int.

Data Path : C:\Projects\Hawaii DOH\2. Laboratory Data\Alpha\WAF Study\L2317027\TPH\NF TPH\  
Data File : f18050523073.D  
Signal(s) : FID2B.ch  
Acq On : 07 May 2023 01:26 pm  
Operator : FID18:AMV  
Sample : L2317027-02F1  
Misc : WG1775373, WG1771478, ICAL19877  
ALS Vial : 87 Sample Multiplier: 1

Integration File: SHCINT2.E  
Quant Time: May 31 15:50:25 2023  
Quant Method : C:\Projects\Hawaii DOH\2. Laboratory Data\Alpha\WAF Study\L2317027\TPH\NF TPH\NF T  
PH Quant.M  
Quant Title : FID Forensics  
QLast Update : Wed May 31 12:22:23 2023  
Response via : Initial Calibration  
Integrator: ChemStation

Volume Inj. : 1.0  
Signal Phase : Rtx-5MS  
Signal Info : 0.25mm

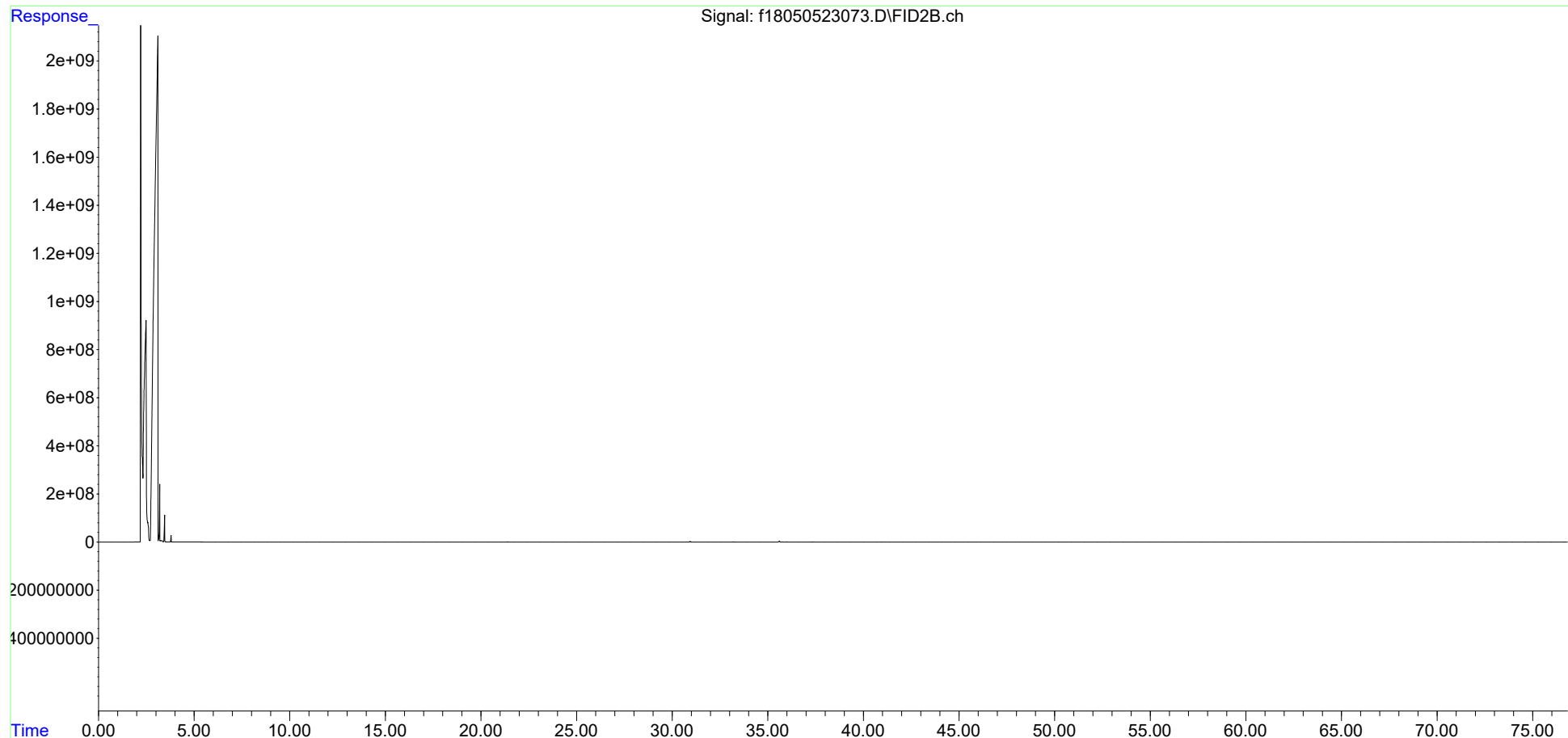

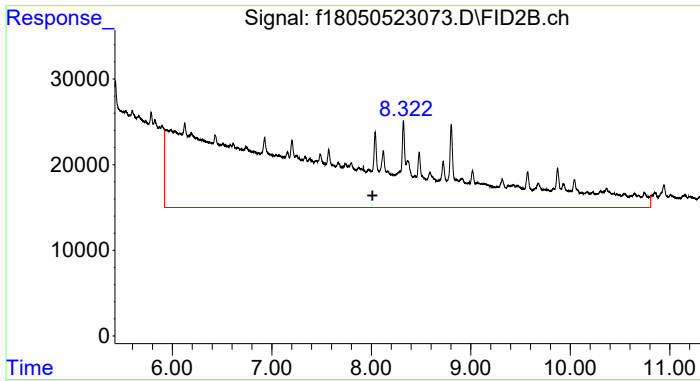

#4 > C8 to C10 Aliphatics

R.T.: 8.012 min  
 Delta R.T.: 0.000 min  
 Response: 13020377  
 Conc: 9.94 ug/mL m

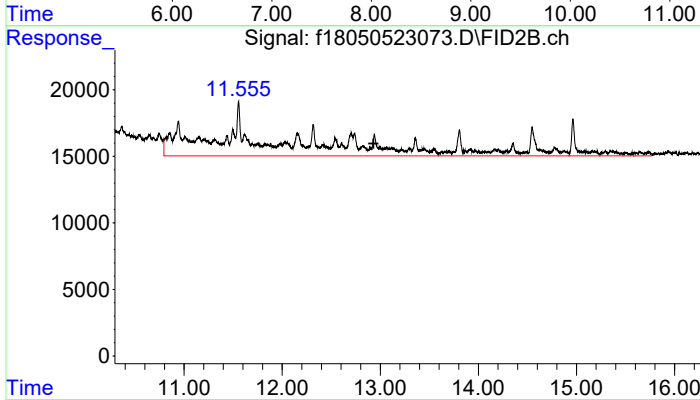

#5 > C10 to C12 Aliphatics

R.T.: 12.930 min  
 Delta R.T.: 0.000 min  
 Response: 2082749  
 Conc: 1.59 ug/ml m

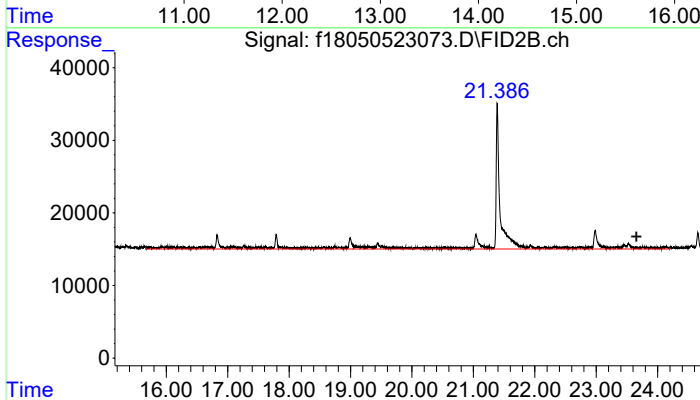

#6 > C12 to C16 Aliphatics

R.T.: 23.659 min  
 Delta R.T.: 0.000 min  
 Response: 2093023  
 Conc: 1.60 UG/ML

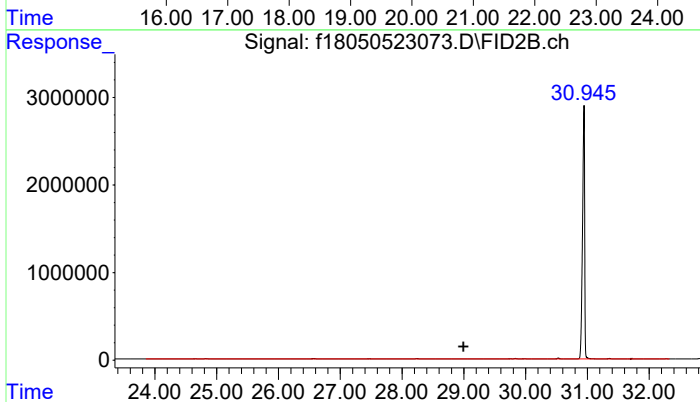

#7 > C16 to C21 Aliphatics

R.T.: 28.995 min  
 Delta R.T.: 0.000 min  
 Response: 2412966  
 Conc: 1.84 UG/ML m

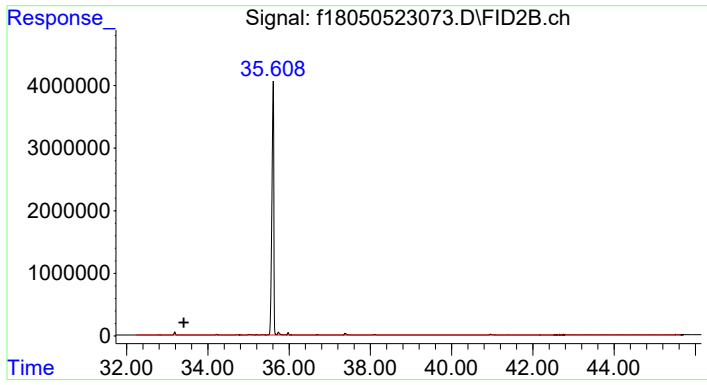

#8 > C21 to C32 Aliphatics

R.T.: 33.402 min  
Delta R.T.: 0.000 min  
Response: 17430404  
Conc: 13.31 UG/ML m

Data Path : C:\Projects\Hawaii DOH\2. Laboratory Data\Alpha\WAF Study\L2317027\TPH\NF TPH\  
 Data File : f18050823019.D  
 Signal(s) : FID2B.ch  
 Acq On : 08 May 2023 09:51 pm  
 Operator : FID18:AMV  
 Sample : L2317027-03F2  
 Misc : WG1776333,WG1771479,ICAL19877  
 ALS Vial : 60 Sample Multiplier: 1

Integration File: SHCINT2.E  
 Quant Time: Jun 01 10:24:43 2023  
 Quant Method : C:\Projects\Hawaii DOH\2. Laboratory Data\Alpha\WAF Study\L2317027\TPH\NF TPH\NF T  
 .. PH Quant.M  
 Quant Title : FID Forensics  
 QLast Update : Mon May 29 22:24:17 2023  
 Response via : Initial Calibration  
 Integrator: ChemStation

Volume Inj. : 1.0  
 Signal Phase : Rtx-5MS  
 Signal Info : 0.25mm

Blank Name : IB1805082301R  
 Blank File : f18050823009.D

Compound	R.T.	Response	Conc Units
-----			
Internal Standards			
1) I 5-alpha-androstane	30.941	62881726	50.000 ug/mL m
System Monitoring Compounds			
2) s ortho-terphenyl	28.965	131614704	100.120 ug/mL m
Spiked Amount 50.000	Range 50 - 130	Recovery	= 200.24%#
Target Compounds			
9) h > C8 to C10 Aromatics	7.704	45281904	38.222 UG/ML m
10) h > C10 to C12 Aromatics	12.274	92096976	77.738 UG/ML m
11) h > C12 to C16 Aromatics	17.385	71558034	60.401 UG/ML m
12) h > C16 to C21 Aromatics	28.995	5748412	4.852 UG/ML m
13) h > C21 to C32 Aromatics	34.889	30937264	26.114 UG/ML m

SemiQuant Compounds - Not Calibrated on this Instrument

(f)=RT Delta > 1/2 Window

(m)=manual int.

Data Path : C:\Projects\Hawaii DOH\2. Laboratory Data\Alpha\WAF Study\L2317027\TPH\NF TPH\  
Data File : f18050823019.D  
Signal(s) : FID2B.ch  
Acq On : 08 May 2023 09:51 pm  
Operator : FID18:AMV  
Sample : L2317027-03F2  
Misc : WG1776333,WG1771479,ICAL19877  
ALS Vial : 60 Sample Multiplier: 1

Integration File: SHCINT2.E  
Quant Time: Jun 01 10:24:43 2023  
Quant Method : C:\Projects\Hawaii DOH\2. Laboratory Data\Alpha\WAF Study\L2317027\TPH\NF TPH\NF T  
PH Quant.M  
Quant Title : FID Forensics  
QLast Update : Mon May 29 22:24:17 2023  
Response via : Initial Calibration  
Integrator: ChemStation

Volume Inj. : 1.0  
Signal Phase : Rtx-5MS  
Signal Info : 0.25mm

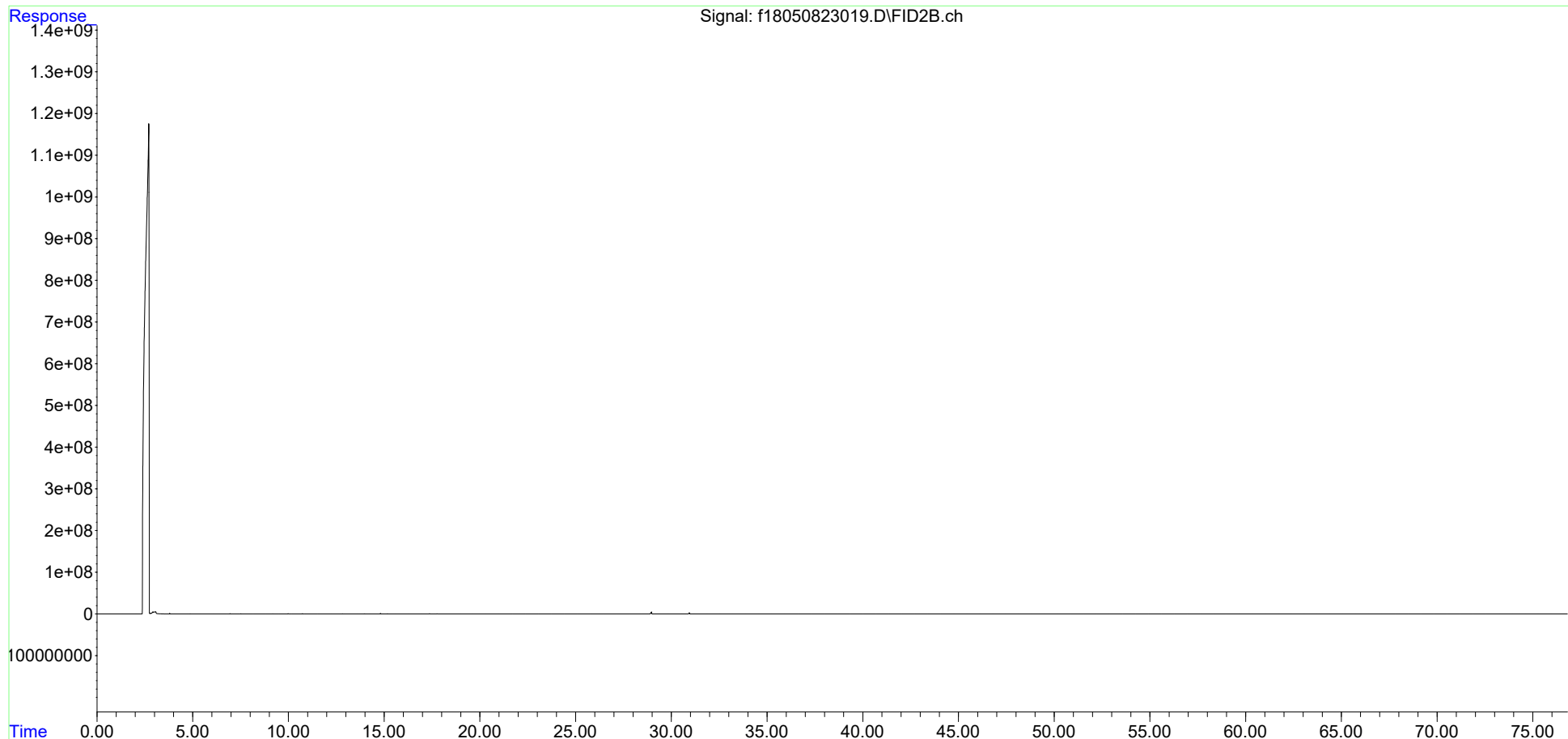

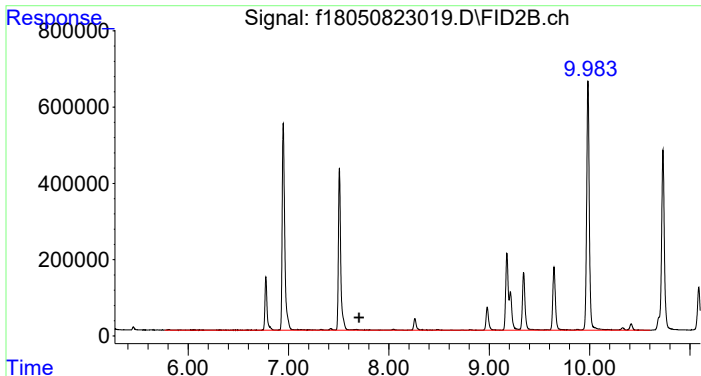

#9 > C8 to C10 Aromatics

R.T.: 7.704 min  
 Delta R.T.: 0.000 min  
 Response: 45281904  
 Conc: 38.22 UG/ML m

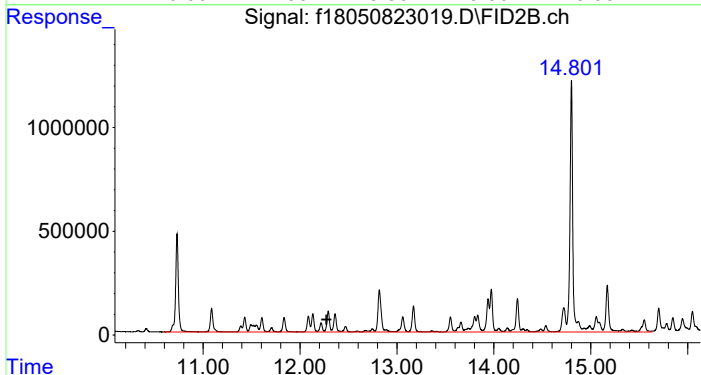

#10 > C10 to C12 Aromatics

R.T.: 12.274 min  
 Delta R.T.: 0.000 min  
 Response: 92096976  
 Conc: 77.74 UG/ML m

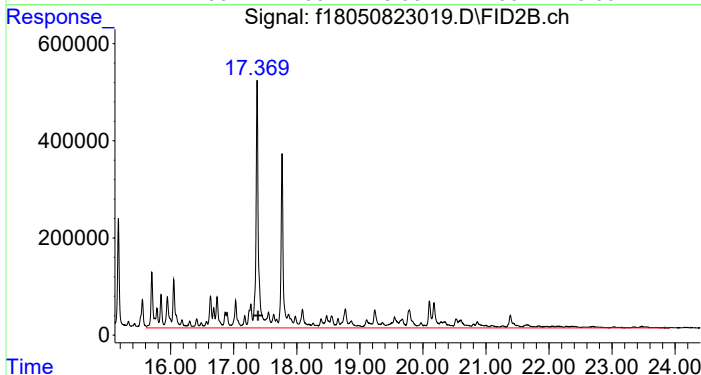

#11 > C12 to C16 Aromatics

R.T.: 17.385 min  
 Delta R.T.: 0.000 min  
 Response: 71558034  
 Conc: 60.40 UG/ML m

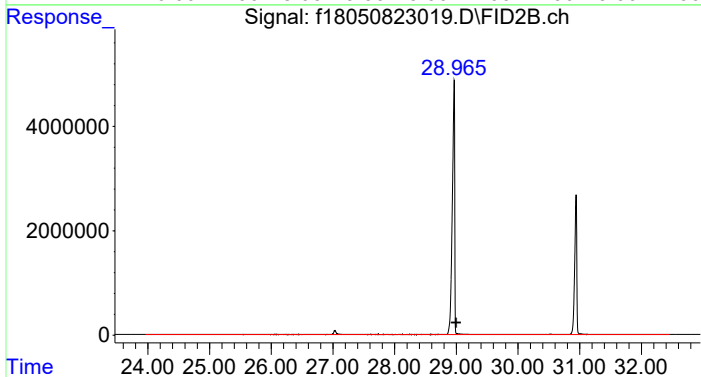

#12 > C16 to C21 Aromatics

R.T.: 28.995 min  
 Delta R.T.: 0.000 min  
 Response: 5748412  
 Conc: 4.85 UG/ML m

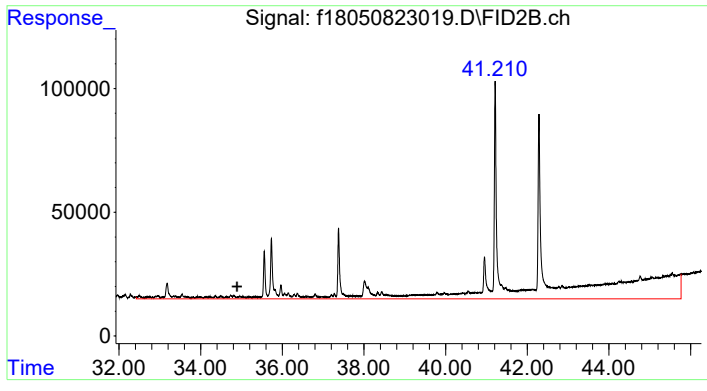

#13 > C21 to C32 Aromatics

R.T.: 34.889 min  
Delta R.T.: 0.000 min  
Response: 30937264  
Conc: 26.11 UG/ML m



Data Path : C:\Projects\Hawaii DOH\2. Laboratory Data\Alpha\WAF Study\L2317027\TPH\NF TPH\  
 Data File : f18042723047.D  
 Signal(s) : FID2B.ch  
 Acq On : 28 Apr 2023 05:59 pm  
 Operator : FID18:AMV  
 Sample : L2317027-04  
 Misc : WG1772069,WG1763893,ICAL19877  
 ALS Vial : 74 Sample Multiplier: 1

Integration File: SHCINT2.E

Quant Time: Jun 01 11:44:49 2023

Quant Method : C:\Projects\Hawaii DOH\2. Laboratory Data\Alpha\WAF Study\L2317027\TPH\NF TPH\NF T  
 PH Quant.M

Quant Title : FID Forensics

QLast Update : Fri Sep 23 15:53:13 2022

Response via : Initial Calibration

Integrator: ChemStation

Volume Inj. : 1.0

Signal Phase : Rtx-5MS

Signal Info : 0.25mm

Blank Name : IB1804272302R

Blank File : f18042723039.D

Compound	R.T.	Response	Conc Units
Internal Standards			
1) I 5-alpha-androstane	31.069	59271112	50.000 ug/mL m
System Monitoring Compounds			
2) s ortho-terphenyl	29.091	140361939	113.278 ug/mL m
Spiked Amount 50.000	Range 50 - 130	Recovery = 226.56%#	
3) s d50-Tetracosane	35.717	117631645	120.065 ug/mL m
Spiked Amount 50.000	Range 50 - 130	Recovery = 240.13%#	
Target Compounds			
4) h > C8 to C10 Aliphatics	8.012	194956025	174.585 ug/mL m
5) h > C10 to C12 Aliphatics	12.930	183136165	164.000 ug/ml m
6) h > C12 to C16 Aliphatics	23.659	258994111	231.932 UG/ML m
7) h > C16 to C21 Aliphatics	28.995	70848050	63.445 UG/ML m
8) h > C21 to C32 Aliphatics	33.402	59312319	53.115 UG/ML m

SemiQuant Compounds - Not Calibrated on this Instrument

(f)=RT Delta > 1/2 Window

(m)=manual int.

Data Path : C:\Projects\Hawaii DOH\2. Laboratory Data\Alpha\WAF Study\L2317027\TPH\NF TPH\  
Data File : f18042723047.D  
Signal(s) : FID2B.ch  
Acq On : 28 Apr 2023 05:59 pm  
Operator : FID18:AMV  
Sample : L2317027-04  
Misc : WG1772069,WG1763893,ICAL19877  
ALS Vial : 74 Sample Multiplier: 1

Integration File: SHCINT2.E  
Quant Time: Jun 01 11:44:49 2023  
Quant Method : C:\Projects\Hawaii DOH\2. Laboratory Data\Alpha\WAF Study\L2317027\TPH\NF TPH\NF T  
... PH Quant.M  
Quant Title : FID Forensics  
QLast Update : Fri Sep 23 15:53:13 2022  
Response via : Initial Calibration  
Integrator: ChemStation

Volume Inj. : 1.0  
Signal Phase : Rtx-5MS  
Signal Info : 0.25mm

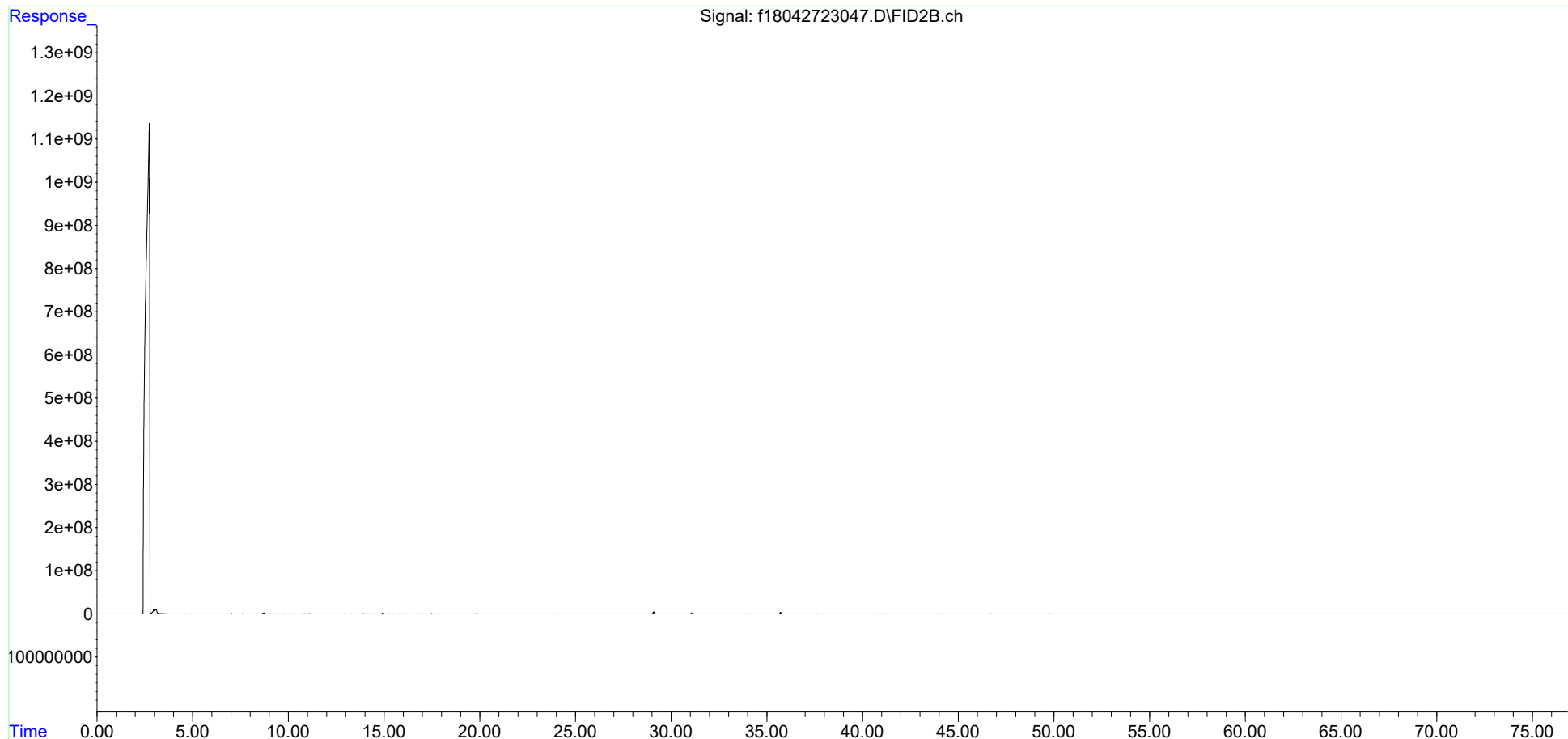

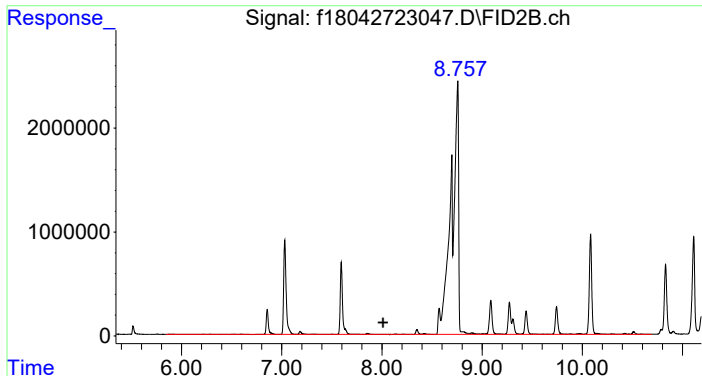

#4 > C8 to C10 Aliphatics

R.T.: 8.012 min  
 Delta R.T.: 0.000 min  
 Response: 194956025  
 Conc: 174.58 ug/mL m

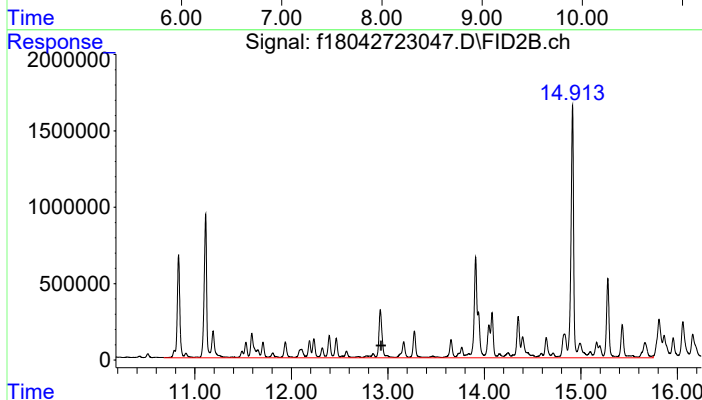

#5 > C10 to C12 Aliphatics

R.T.: 12.930 min  
 Delta R.T.: 0.000 min  
 Response: 183136165  
 Conc: 164.00 ug/ml m

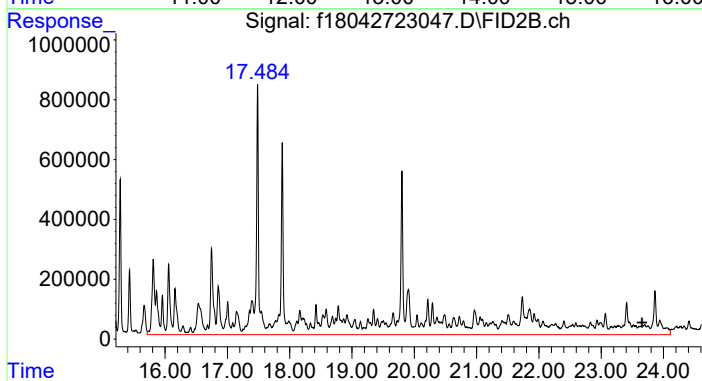

#6 > C12 to C16 Aliphatics

R.T.: 23.659 min  
 Delta R.T.: 0.000 min  
 Response: 258994111  
 Conc: 231.93 UG/ML m

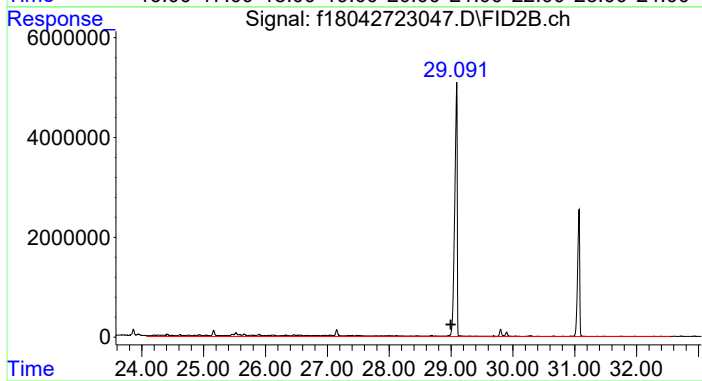

#7 > C16 to C21 Aliphatics

R.T.: 28.995 min  
 Delta R.T.: 0.000 min  
 Response: 70848050  
 Conc: 63.45 UG/ML m

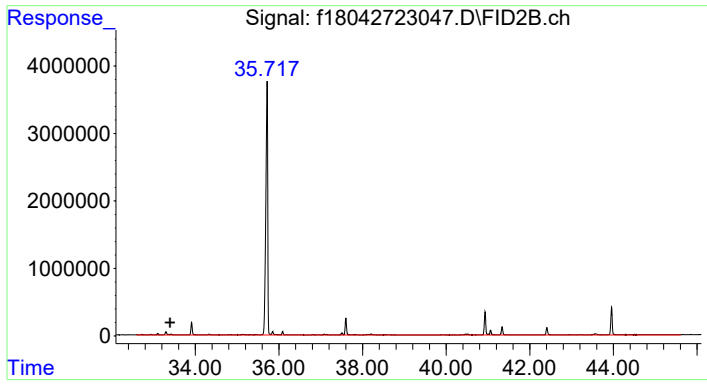

#8 > C21 to C32 Aliphatics

R.T.: 33.402 min  
Delta R.T.: 0.000 min  
Response: 59312319  
Conc: 53.11 UG/ML m

Data Path : C:\Projects\Hawaii DOH\2. Laboratory Data\Alpha\WAF Study\L2317027\TPH\NF TPH\  
 Data File : f18050523075.D  
 Signal(s) : FID2B.ch  
 Acq On : 07 May 2023 02:50 pm  
 Operator : FID18:AMV  
 Sample : L2317027-05F1  
 Misc : WG1775373,WG1771478,ICAL19877  
 ALS Vial : 88 Sample Multiplier: 1

Integration File: SHCINT2.E  
 Quant Time: May 31 15:55:29 2023  
 Quant Method : C:\Projects\Hawaii DOH\2. Laboratory Data\Alpha\WAF Study\L2317027\TPH\NF TPH\NF T  
 .. PH Quant.M  
 Quant Title : FID Forensics  
 QLast Update : Fri Sep 23 15:53:13 2022  
 Response via : Initial Calibration  
 Integrator: ChemStation

Volume Inj. : 1.0  
 Signal Phase : Rtx-5MS  
 Signal Info : 0.25mm

Blank Name : IB1805052303R  
 Blank File : f18050523061.D

Compound	R.T.	Response	Conc Units
-----			
Internal Standards			
1) I 5-alpha-androstane	30.944	65074700	50.000 ug/mL m
System Monitoring Compounds			
3) s d50-Tetracosane	35.607	124671897	115.903 ug/mL m
Spiked Amount 50.000	Range 50 - 130	Recovery	= 231.81%#
Target Compounds			
4) h > C8 to C10 Aliphatics	8.012	16668529	13.596 ug/mL m
5) h > C10 to C12 Aliphatics	12.930	3170169	2.586 ug/ml m
6) h > C12 to C16 Aliphatics	23.659	1971858	1.608 UG/ML m
7) h > C16 to C21 Aliphatics	28.995	2931534	2.391 UG/ML m
8) h > C21 to C32 Aliphatics	33.402	17273325	14.089 UG/ML m

SemiQuant Compounds - Not Calibrated on this Instrument

(f)=RT Delta > 1/2 Window

(m)=manual int.

Data Path : C:\Projects\Hawaii DOH\2. Laboratory Data\Alpha\WAF Study\L2317027\TPH\NF TPH\  
Data File : f18050523075.D  
Signal(s) : FID2B.ch  
Acq On : 07 May 2023 02:50 pm  
Operator : FID18:AMV  
Sample : L2317027-05F1  
Misc : WG1775373, WG1771478, ICAL19877  
ALS Vial : 88 Sample Multiplier: 1

Integration File: SHCINT2.E  
Quant Time: May 31 15:55:29 2023  
Quant Method : C:\Projects\Hawaii DOH\2. Laboratory Data\Alpha\WAF Study\L2317027\TPH\NF TPH\NF T  
... PH Quant.M  
Quant Title : FID Forensics  
QLast Update : Fri Sep 23 15:53:13 2022  
Response via : Initial Calibration  
Integrator: ChemStation

Volume Inj. : 1.0  
Signal Phase : Rtx-5MS  
Signal Info : 0.25mm

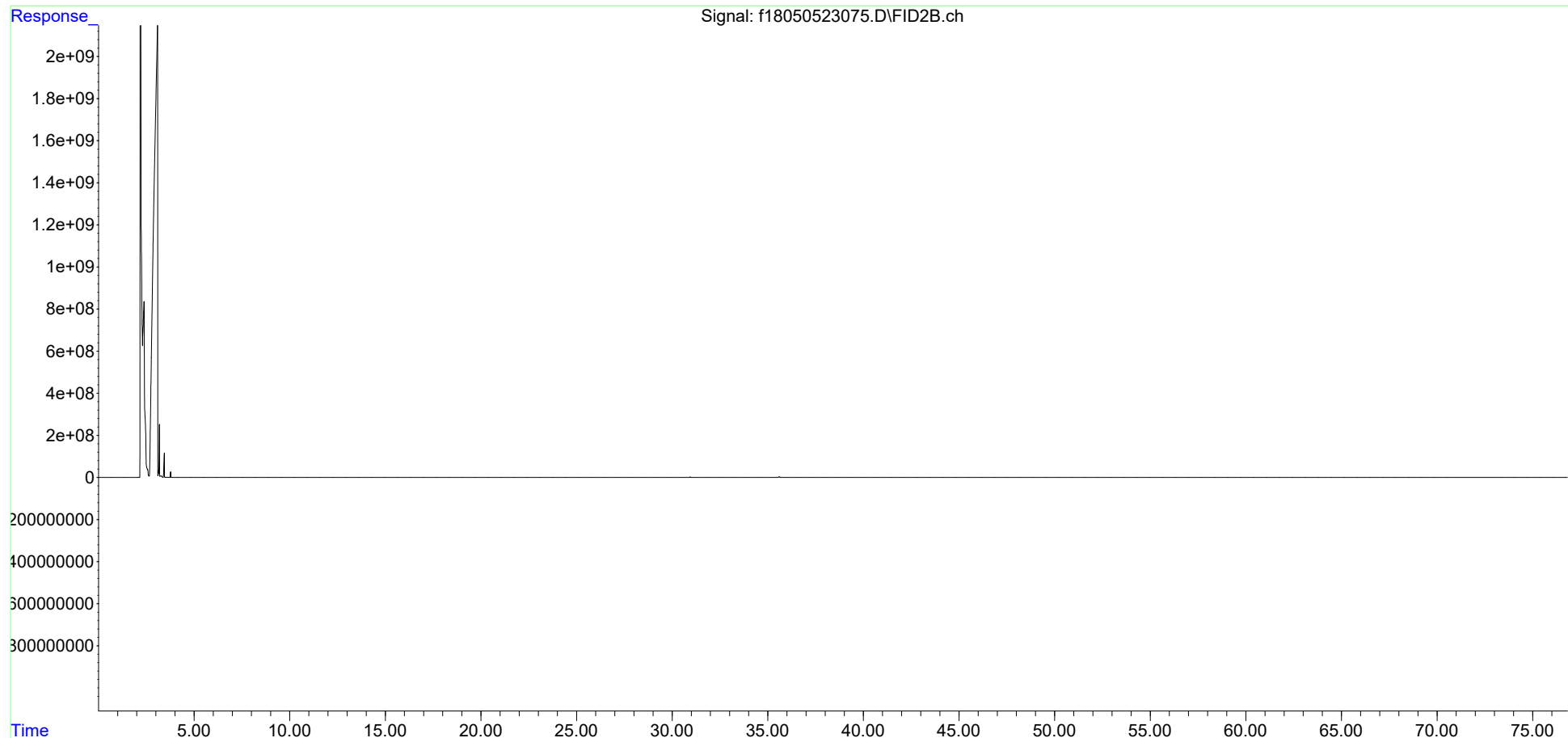

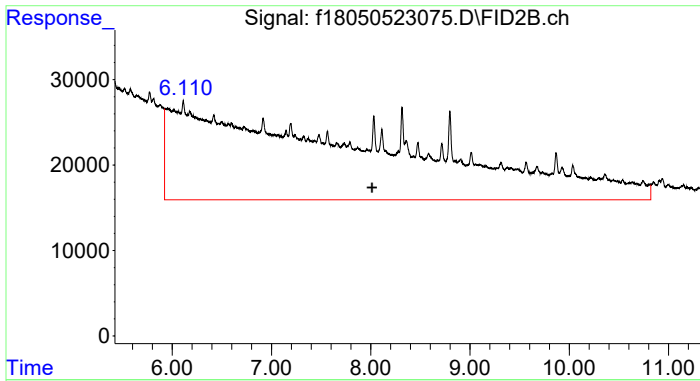

#4 > C8 to C10 Aliphatics

R.T.: 8.012 min  
 Delta R.T.: 0.000 min  
 Response: 16668529  
 Conc: 13.60 ug/mL m

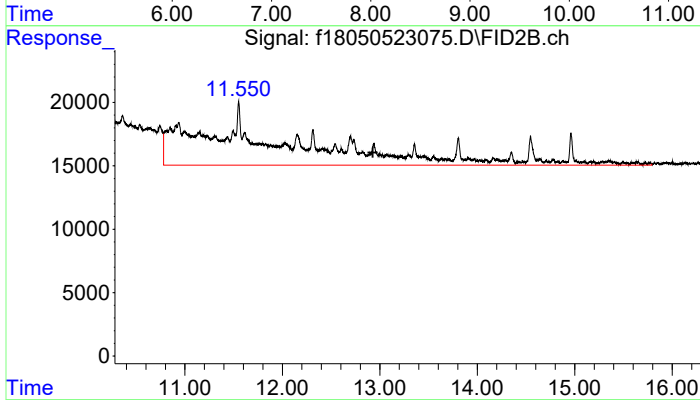

#5 > C10 to C12 Aliphatics

R.T.: 12.930 min  
 Delta R.T.: 0.000 min  
 Response: 3170169  
 Conc: 2.59 ug/ml m

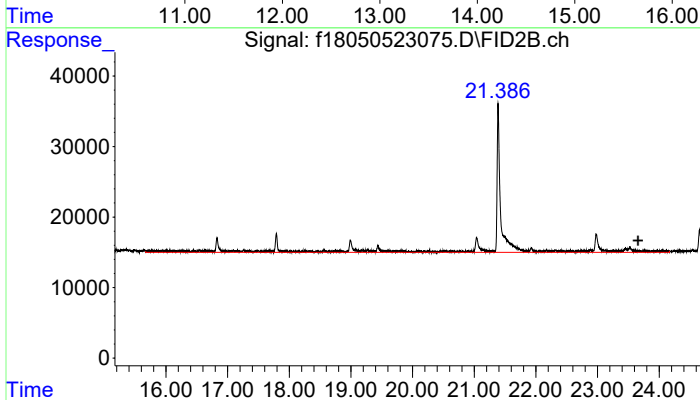

#6 > C12 to C16 Aliphatics

R.T.: 23.659 min  
 Delta R.T.: 0.000 min  
 Response: 1971858  
 Conc: 1.61 UG/ML m

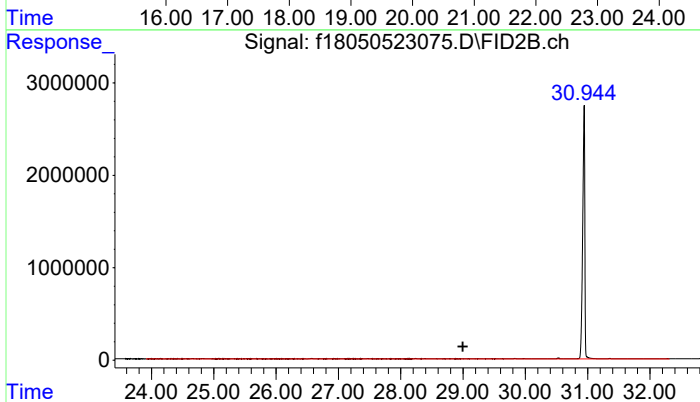

#7 > C16 to C21 Aliphatics

R.T.: 28.995 min  
 Delta R.T.: 0.000 min  
 Response: 2931534  
 Conc: 2.39 UG/ML m

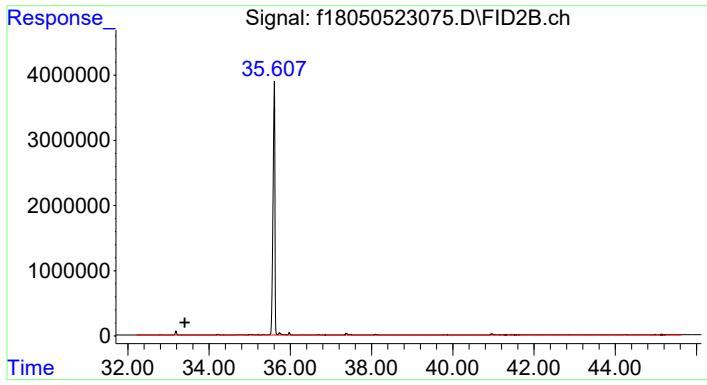

#8 > C21 to C32 Aliphatics

R.T.: 33.402 min  
Delta R.T.: 0.000 min  
Response: 17273325  
Conc: 14.09 UG/ML m



Data Path : C:\Projects\Hawaii DOH\2. Laboratory Data\Alpha\WAF Study\L2317027\TPH\NF TPH\  
 Data File : f18050823021.D  
 Signal(s) : FID2B.ch  
 Acq On : 08 May 2023 11:15 pm  
 Operator : FID18:AMV  
 Sample : L2317027-06F2  
 Misc : WG1776333,WG1771479,ICAL19877  
 ALS Vial : 61 Sample Multiplier: 1

Integration File: SHCINT2.E  
 Quant Time: May 30 13:10:40 2023  
 Quant Method : C:\Projects\Hawaii DOH\2. Laboratory Data\Alpha\WAF Study\L2317027\TPH\NF TPH\NF T  
 .. PH Quant.M  
 Quant Title : FID Forensics  
 QLast Update : Fri Sep 23 15:53:13 2022  
 Response via : Initial Calibration  
 Integrator: ChemStation

Volume Inj. : 1.0  
 Signal Phase : Rtx-5MS  
 Signal Info : 0.25mm

Blank Name : IB1805082301R  
 Blank File : f18050823009.D

Compound	R.T.	Response	Conc Units
-----			
Internal Standards			
1) I 5-alpha-androstane	30.943	65492620	50.000 ug/mL m
System Monitoring Compounds			
2) s ortho-terphenyl	28.965	137884040	100.707 ug/mL m
Spiked Amount 50.000	Range 50 - 130	Recovery	= 201.41%#
Target Compounds			
9) h > C8 to C10 Aromatics	7.704	46241059	37.476 UG/ML m
10) h > C10 to C12 Aromatics	12.274	83710694	67.842 UG/ML m
11) h > C12 to C16 Aromatics	17.385	64373749	52.171 UG/ML m
12) h > C16 to C21 Aromatics	28.995	8372652	6.786 UG/ML m
13) h > C21 to C32 Aromatics	34.889	21052895	17.062 UG/ML m

SemiQuant Compounds - Not Calibrated on this Instrument

(f)=RT Delta > 1/2 Window

(m)=manual int.

Data Path : C:\Projects\Hawaii DOH\2. Laboratory Data\Alpha\WAF Study\L2317027\TPH\NF TPH\  
Data File : f18050823021.D  
Signal(s) : FID2B.ch  
Acq On : 08 May 2023 11:15 pm  
Operator : FID18:AMV  
Sample : L2317027-06F2  
Misc : WG1776333, WG1771479, ICAL19877  
ALS Vial : 61 Sample Multiplier: 1

Integration File: SHCINT2.E  
Quant Time: May 30 13:10:40 2023  
Quant Method : C:\Projects\Hawaii DOH\2. Laboratory Data\Alpha\WAF Study\L2317027\TPH\NF TPH\NF T  
... PH Quant.M  
Quant Title : FID Forensics  
QLast Update : Fri Sep 23 15:53:13 2022  
Response via : Initial Calibration  
Integrator: ChemStation

Volume Inj. : 1.0  
Signal Phase : Rtx-5MS  
Signal Info : 0.25mm

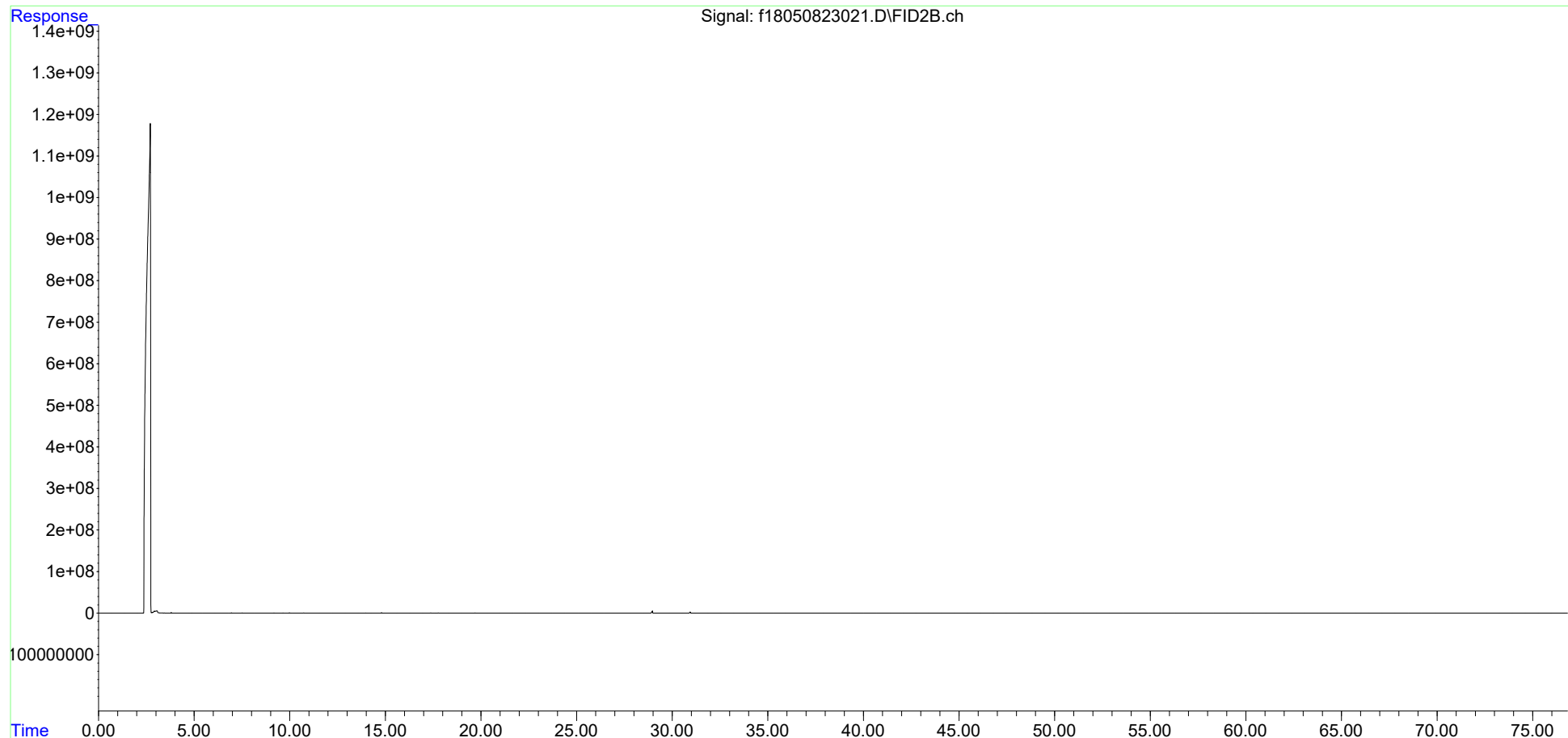

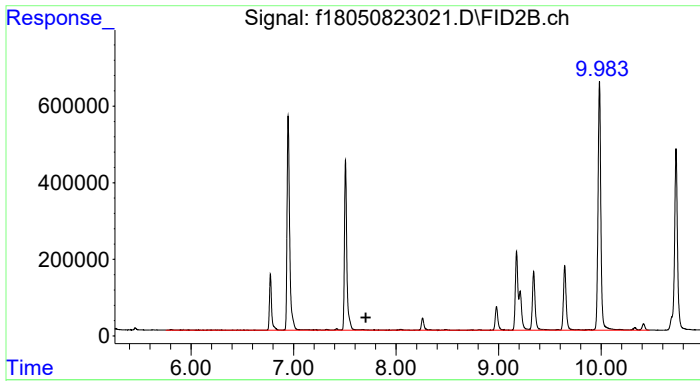

#9 > C8 to C10 Aromatics  
 R.T.: 7.704 min  
 Delta R.T.: 0.000 min  
 Response: 46241059  
 Conc: 37.48 UG/ML m

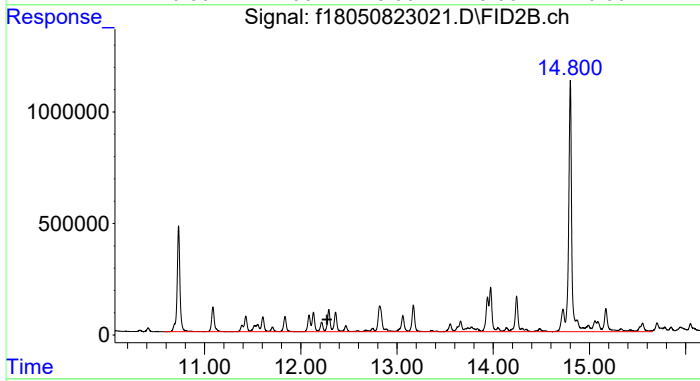

#10 > C10 to C12 Aromatics  
 R.T.: 12.274 min  
 Delta R.T.: 0.000 min  
 Response: 83710694  
 Conc: 67.84 UG/ML m

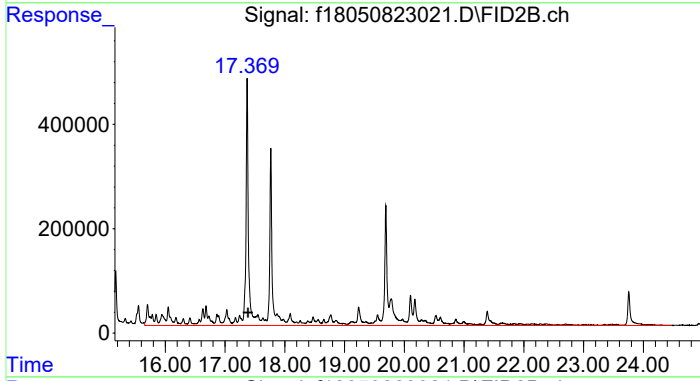

#11 > C12 to C16 Aromatics  
 R.T.: 17.385 min  
 Delta R.T.: 0.000 min  
 Response: 64373749  
 Conc: 52.17 UG/ML m

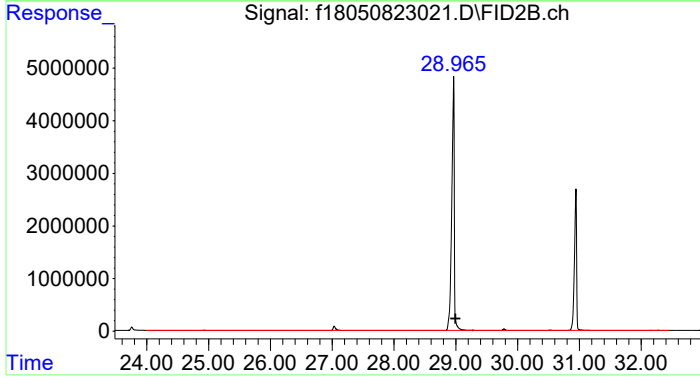

#12 > C16 to C21 Aromatics  
 R.T.: 28.995 min  
 Delta R.T.: 0.000 min  
 Response: 8372652  
 Conc: 6.79 UG/ML m

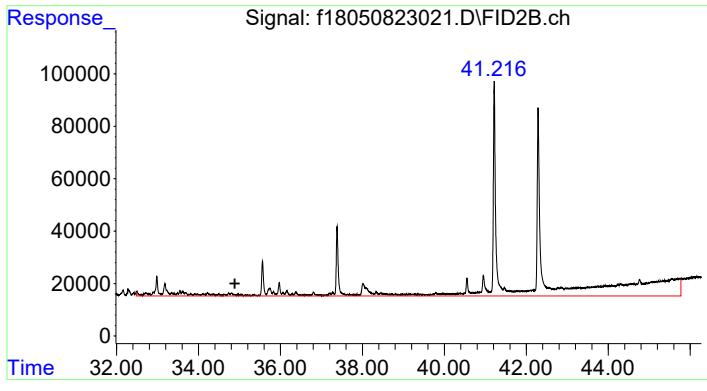

#13 > C21 to C32 Aromatics

R.T.: 34.889 min  
Delta R.T.: 0.000 min  
Response: 21052895  
Conc: 17.06 UG/ML m

Data Path : C:\Projects\Hawaii DOH\2. Laboratory Data\Alpha\WAF Study\L2317027\TPH\NF TPH\  
 Data File : f18042723049.D  
 Signal(s) : FID2B.ch  
 Acq On : 28 Apr 2023 07:22 pm  
 Operator : FID18:AMV  
 Sample : L2317027-07  
 Misc : WG1772069,WG1763893,ICAL19877  
 ALS Vial : 75 Sample Multiplier: 1

Integration File: SHCINT2.E  
 Quant Time: Jun 01 12:17:07 2023  
 Quant Method : C:\Projects\Hawaii DOH\2. Laboratory Data\Alpha\WAF Study\L2317027\TPH\NF TPH\NF T  
 .. PH Quant.M  
 Quant Title : FID Forensics  
 QLast Update : Fri Sep 23 15:53:13 2022  
 Response via : Initial Calibration  
 Integrator: ChemStation

Volume Inj. : 1.0  
 Signal Phase : Rtx-5MS  
 Signal Info : 0.25mm

Blank Name : IB1804272302R  
 Blank File : f18042723039.D

Compound	R.T.	Response	Conc Units
-----			
Internal Standards			
1) I 5-alpha-androstane	31.069	64991354	50.000 ug/mL m
System Monitoring Compounds			
2) s ortho-terphenyl	29.093	150071433	110.454 ug/mL m
Spiked Amount 50.000	Range 50 - 130	Recovery = 220.91%#	
3) s d50-Tetracosane	35.721	125531683	116.851 ug/mL m
Spiked Amount 50.000	Range 50 - 130	Recovery = 233.70%#	
Target Compounds			
4) h > C8 to C10 Aliphatics	8.012	597748988	488.176 ug/mL m
5) h > C10 to C12 Aliphatics	12.930	1004562007	820.416 ug/ml m
6) h > C12 to C16 Aliphatics	23.659	940079959	767.754 UG/ML m
7) h > C16 to C21 Aliphatics	28.995	102501821	83.712 UG/ML m
8) h > C21 to C32 Aliphatics	33.402	36028452	29.424 UG/ML m

SemiQuant Compounds - Not Calibrated on this Instrument

(f)=RT Delta > 1/2 Window

(m)=manual int.

Data Path : C:\Projects\Hawaii DOH\2. Laboratory Data\Alpha\WAF Study\L2317027\TPH\NF TPH\  
Data File : f18042723049.D  
Signal(s) : FID2B.ch  
Acq On : 28 Apr 2023 07:22 pm  
Operator : FID18:AMV  
Sample : L2317027-07  
Misc : WG1772069,WG1763893,ICAL19877  
ALS Vial : 75 Sample Multiplier: 1

Integration File: SHCINT2.E  
Quant Time: Jun 01 12:17:07 2023  
Quant Method : C:\Projects\Hawaii DOH\2. Laboratory Data\Alpha\WAF Study\L2317027\TPH\NF TPH\NF T  
... PH Quant.M  
Quant Title : FID Forensics  
QLast Update : Fri Sep 23 15:53:13 2022  
Response via : Initial Calibration  
Integrator: ChemStation

Volume Inj. : 1.0  
Signal Phase : Rtx-5MS  
Signal Info : 0.25mm

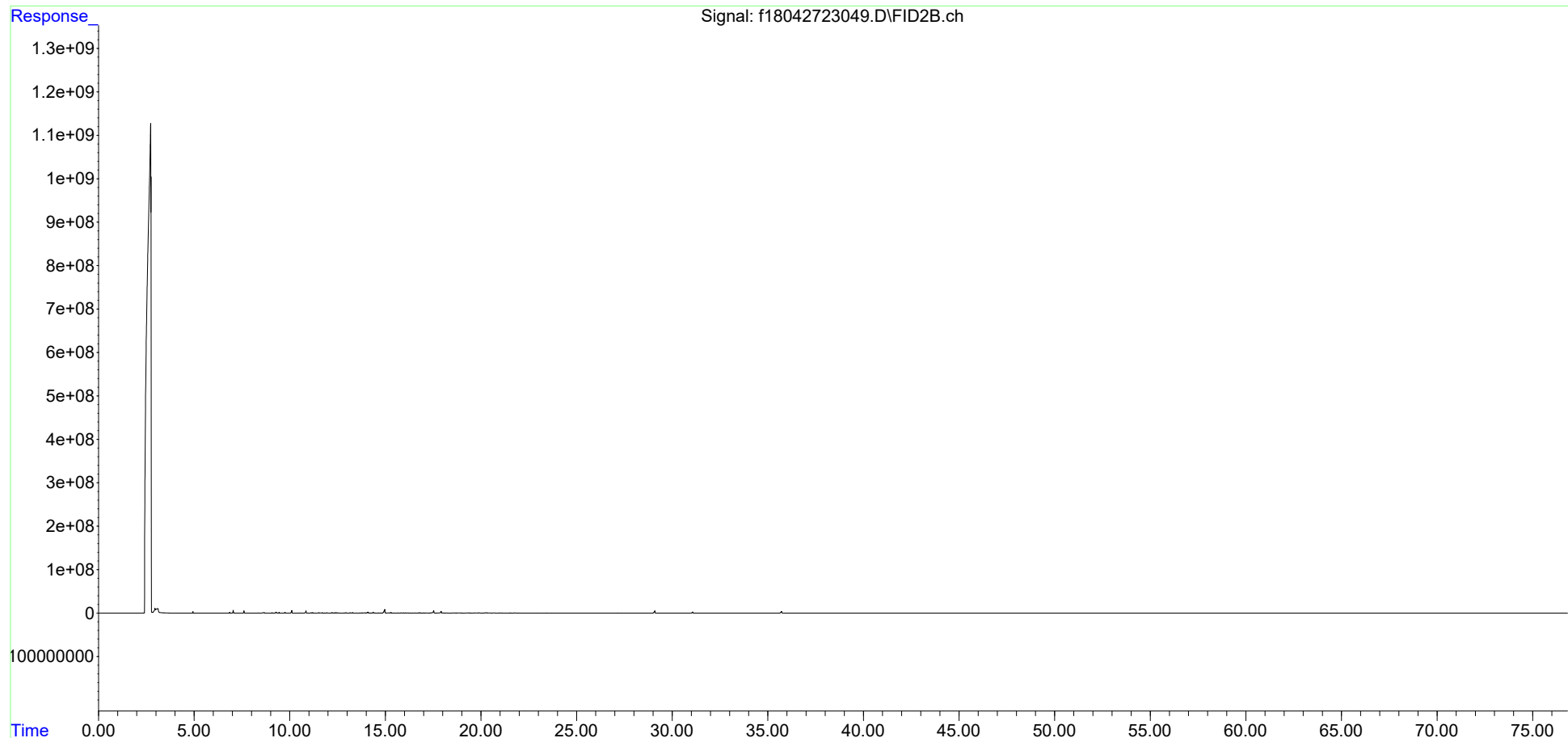

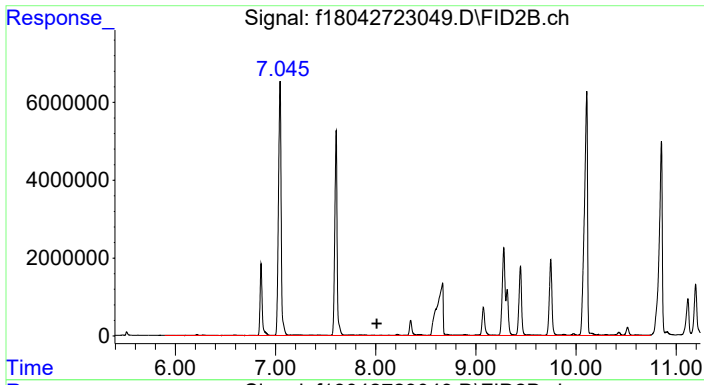

#4 > C8 to C10 Aliphatics

R.T.: 8.012 min  
 Delta R.T.: 0.000 min  
 Response: 597748988  
 Conc: 488.18 ug/mL m

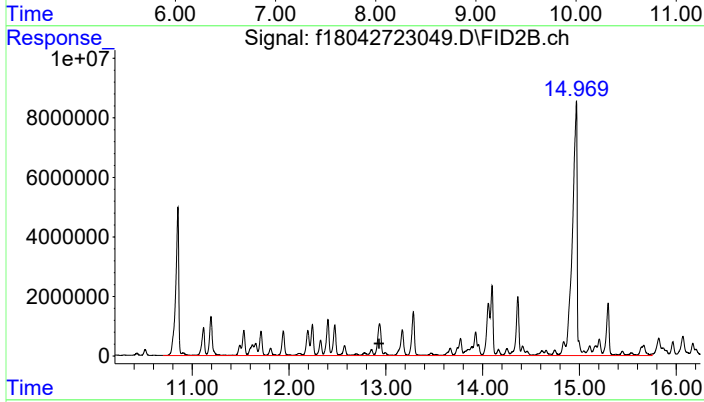

#5 > C10 to C12 Aliphatics

R.T.: 12.930 min  
 Delta R.T.: 0.000 min  
 Response: 1004562007  
 Conc: 820.42 ug/ml m

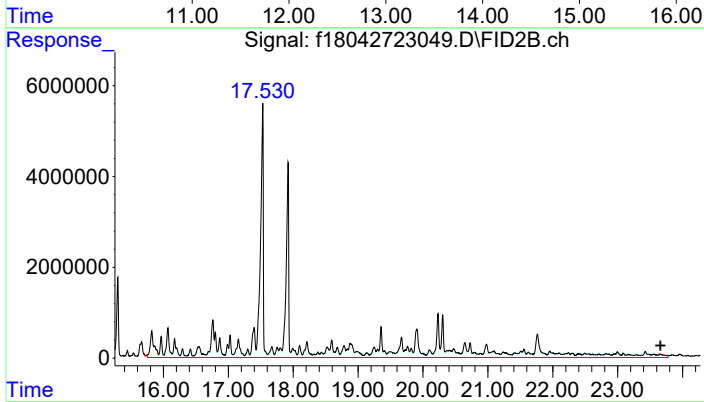

#6 > C12 to C16 Aliphatics

R.T.: 23.659 min  
 Delta R.T.: 0.000 min  
 Response: 940079959  
 Conc: 767.75 UG/ML m

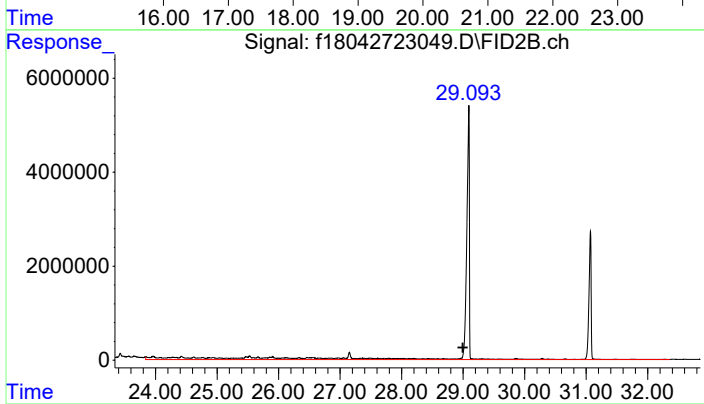

#7 > C16 to C21 Aliphatics

R.T.: 28.995 min  
 Delta R.T.: 0.000 min  
 Response: 102501821  
 Conc: 83.71 UG/ML m

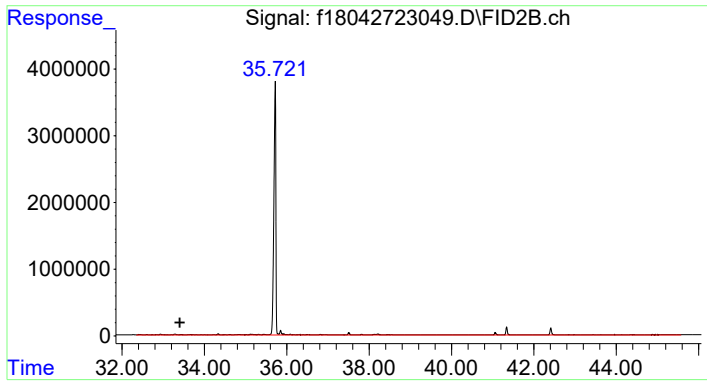

#8 > C21 to C32 Aliphatics

R.T.: 33.402 min  
Delta R.T.: 0.000 min  
Response: 36028452  
Conc: 29.42 UG/ML m



Data Path : C:\Projects\Hawaii DOH\2. Laboratory Data\Alpha\WAF Study\L2317027\TPH\NF TPH\  
 Data File : f18050523077.D  
 Signal(s) : FID2B.ch  
 Acq On : 07 May 2023 04:14 pm  
 Operator : FID18:AMV  
 Sample : L2317027-08F1  
 Misc : WG1775373,WG1771478,ICAL19877  
 ALS Vial : 89 Sample Multiplier: 1

Integration File: SHCINT2.E  
 Quant Time: May 31 16:02:55 2023  
 Quant Method : C:\Projects\Hawaii DOH\2. Laboratory Data\Alpha\WAF Study\L2317027\TPH\NF TPH\NF T  
 .. PH Quant.M  
 Quant Title : FID Forensics  
 QLast Update : Fri Sep 23 15:53:13 2022  
 Response via : Initial Calibration  
 Integrator: ChemStation

Volume Inj. : 1.0  
 Signal Phase : Rtx-5MS  
 Signal Info : 0.25mm

Blank Name : IB1805052303R  
 Blank File : f18050523061.D

Compound	R.T.	Response	Conc Units
-----			
Internal Standards			
1) I 5-alpha-androstane	30.943	68846897	50.000 ug/mL m
System Monitoring Compounds			
3) s d50-Tetracosane	35.607	128426640	112.851 ug/mL m
Spiked Amount 50.000	Range 50 - 130	Recovery	= 225.70%#
Target Compounds			
4) h > C8 to C10 Aliphatics	8.012	23195325	17.883 ug/mL m
5) h > C10 to C12 Aliphatics	12.930	7201046	5.552 ug/ml m
6) h > C12 to C16 Aliphatics	23.659	2602229	2.006 UG/ML m
7) h > C16 to C21 Aliphatics	28.995	2727965	2.103 UG/ML m
8) h > C21 to C32 Aliphatics	33.402	17330195	13.361 UG/ML m

SemiQuant Compounds - Not Calibrated on this Instrument

(f)=RT Delta > 1/2 Window

(m)=manual int.

Data Path : C:\Projects\Hawaii DOH\2. Laboratory Data\Alpha\WAF Study\L2317027\TPH\NF TPH\  
Data File : f18050523077.D  
Signal(s) : FID2B.ch  
Acq On : 07 May 2023 04:14 pm  
Operator : FID18:AMV  
Sample : L2317027-08F1  
Misc : WG1775373, WG1771478, ICAL19877  
ALS Vial : 89 Sample Multiplier: 1

Integration File: SHCINT2.E  
Quant Time: May 31 16:02:55 2023  
Quant Method : C:\Projects\Hawaii DOH\2. Laboratory Data\Alpha\WAF Study\L2317027\TPH\NF TPH\NF T  
... PH Quant.M  
Quant Title : FID Forensics  
QLast Update : Fri Sep 23 15:53:13 2022  
Response via : Initial Calibration  
Integrator: ChemStation

Volume Inj. : 1.0  
Signal Phase : Rtx-5MS  
Signal Info : 0.25mm

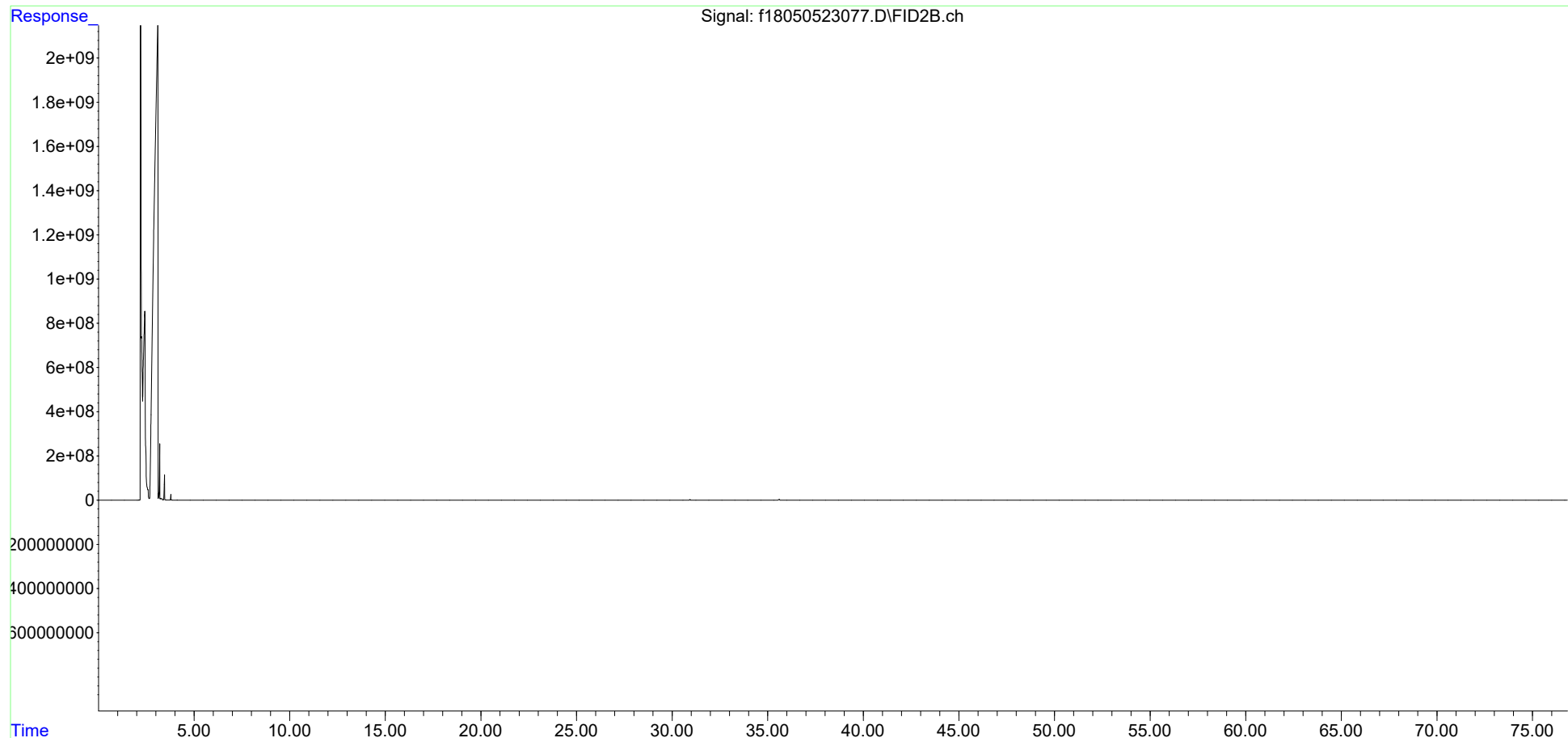

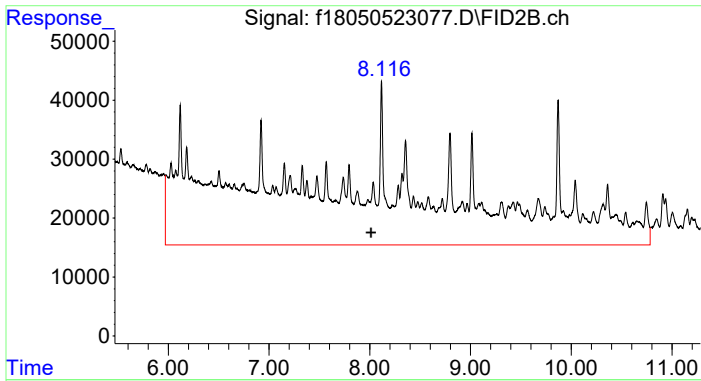

#4 > C8 to C10 Aliphatics

R.T.: 8.012 min  
 Delta R.T.: 0.000 min  
 Response: 23195325  
 Conc: 17.88 ug/mL m

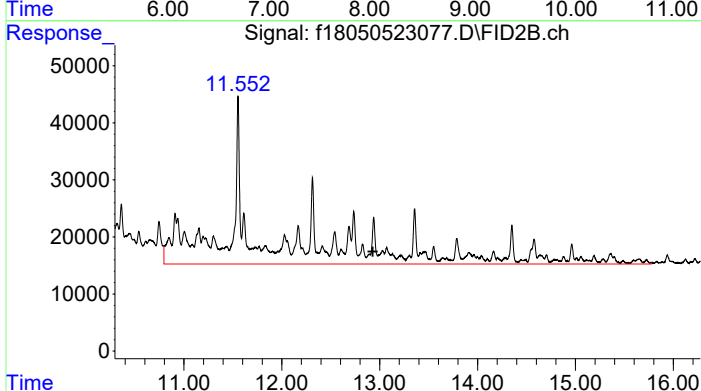

#5 > C10 to C12 Aliphatics

R.T.: 12.930 min  
 Delta R.T.: 0.000 min  
 Response: 7201046  
 Conc: 5.55 ug/ml m

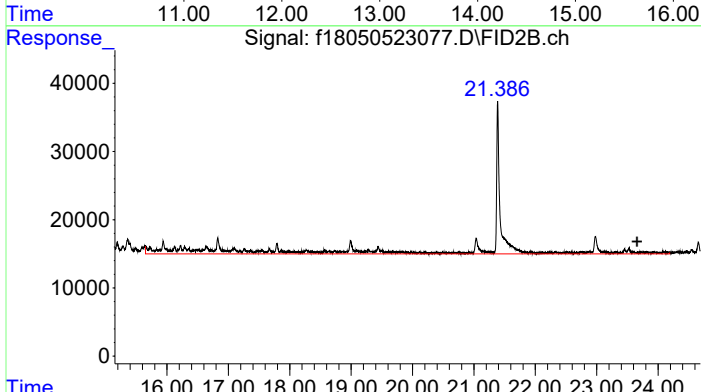

#6 > C12 to C16 Aliphatics

R.T.: 23.659 min  
 Delta R.T.: 0.000 min  
 Response: 2602229  
 Conc: 2.01 UG/ML m

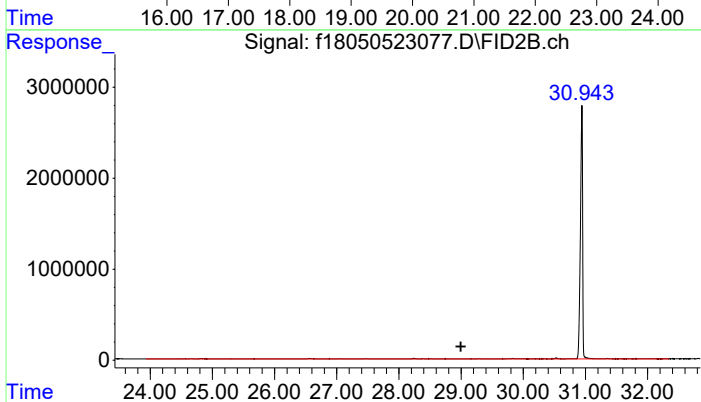

#7 > C16 to C21 Aliphatics

R.T.: 28.995 min  
 Delta R.T.: 0.000 min  
 Response: 2727965  
 Conc: 2.10 UG/ML m

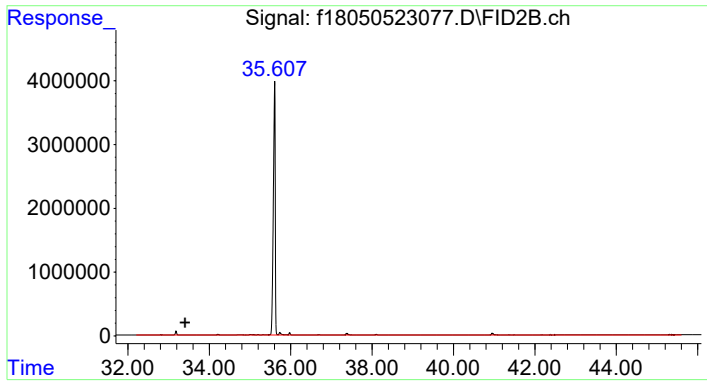

#8 > C21 to C32 Aliphatics

R.T.: 33.402 min  
Delta R.T.: 0.000 min  
Response: 17330195  
Conc: 13.36 UG/ML m

Data Path : C:\Projects\Hawaii DOH\2. Laboratory Data\Alpha\WAF Study\L2317027\TPH\NF TPH\  
 Data File : f18050823023.D  
 Signal(s) : FID2B.ch  
 Acq On : 09 May 2023 12:39 am  
 Operator : FID18:AMV  
 Sample : L2317027-09F2  
 Misc : WG1776333,WG1771479,ICAL19877  
 ALS Vial : 62 Sample Multiplier: 1

Integration File: SHCINT2.E  
 Quant Time: Jun 01 10:36:05 2023  
 Quant Method : C:\Projects\Hawaii DOH\2. Laboratory Data\Alpha\WAF Study\L2317027\TPH\NF TPH\NF T  
 .. PH Quant.M  
 Quant Title : FID Forensics  
 QLast Update : Fri Sep 23 15:53:13 2022  
 Response via : Initial Calibration  
 Integrator: ChemStation

Volume Inj. : 1.0  
 Signal Phase : Rtx-5MS  
 Signal Info : 0.25mm

Blank Name : IB1805082301R  
 Blank File : f18050823009.D

Compound	R.T.	Response	Conc Units
-----			
Internal Standards			
1) I 5-alpha-androstane	30.942	63074968	50.000 ug/mL m
System Monitoring Compounds			
2) s ortho-terphenyl	28.962	126843308	96.194 ug/mL m
Spiked Amount 50.000	Range 50 - 130	Recovery =	192.39%#
Target Compounds			
9) h > C8 to C10 Aromatics	7.704	335466354	282.296 UG/ML m
10) h > C10 to C12 Aromatics	12.274	627409542	527.967 UG/ML m
11) h > C12 to C16 Aromatics	17.385	403184711	339.281 UG/ML m
12) h > C16 to C21 Aromatics	28.995	9718501	8.178 UG/ML m
13) h > C21 to C32 Aromatics	34.889	22850747	19.229 UG/ML m

SemiQuant Compounds - Not Calibrated on this Instrument

(f)=RT Delta > 1/2 Window

(m)=manual int.

Data Path : C:\Projects\Hawaii DOH\2. Laboratory Data\Alpha\WAF Study\L2317027\TPH\NF TPH\  
Data File : f18050823023.D  
Signal(s) : FID2B.ch  
Acq On : 09 May 2023 12:39 am  
Operator : FID18:AMV  
Sample : L2317027-09F2  
Misc : WG1776333,WG1771479,ICAL19877  
ALS Vial : 62 Sample Multiplier: 1

Integration File: SHCINT2.E  
Quant Time: Jun 01 10:36:05 2023  
Quant Method : C:\Projects\Hawaii DOH\2. Laboratory Data\Alpha\WAF Study\L2317027\TPH\NF TPH\NF T  
PH Quant.M  
Quant Title : FID Forensics  
QLast Update : Fri Sep 23 15:53:13 2022  
Response via : Initial Calibration  
Integrator: ChemStation

Volume Inj. : 1.0  
Signal Phase : Rtx-5MS  
Signal Info : 0.25mm

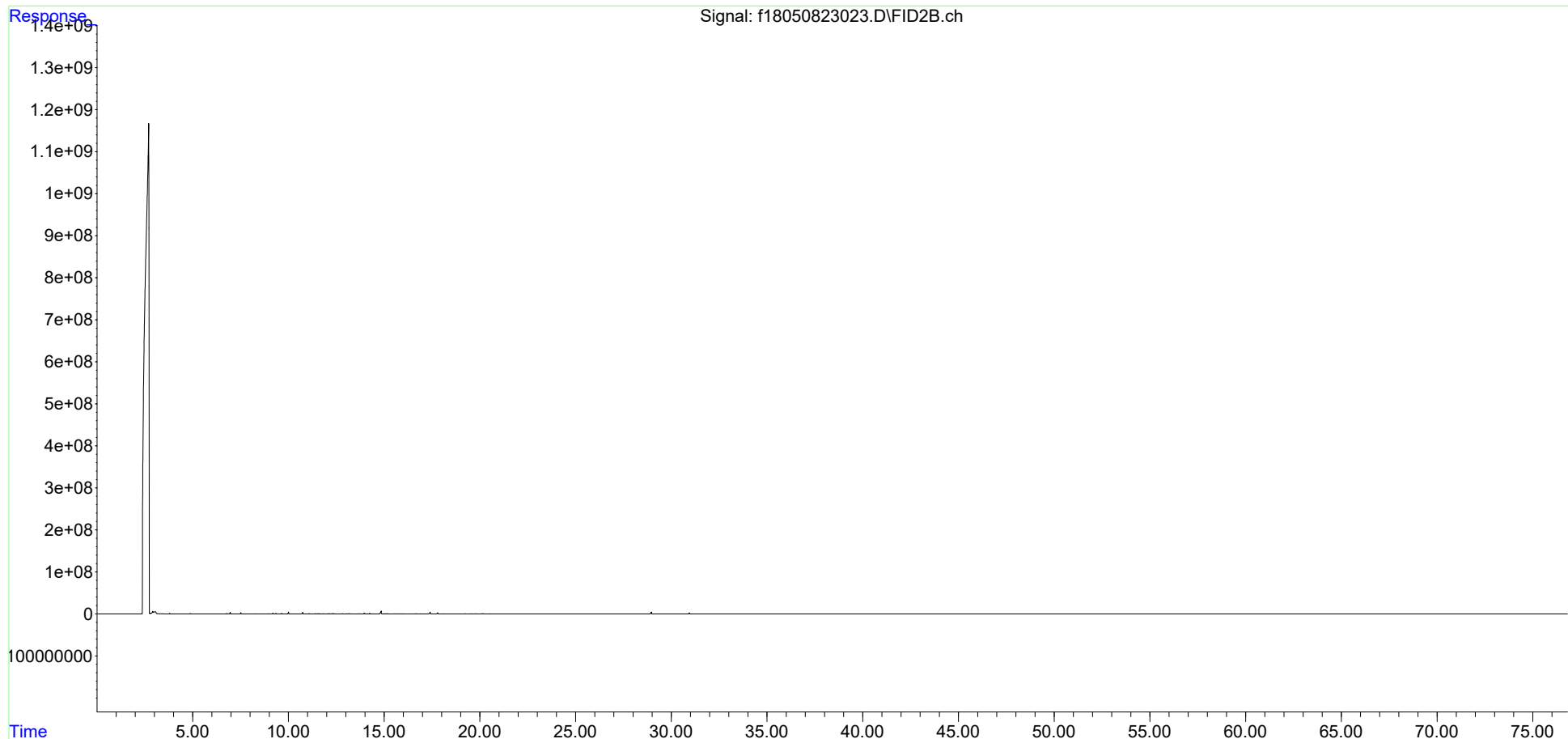

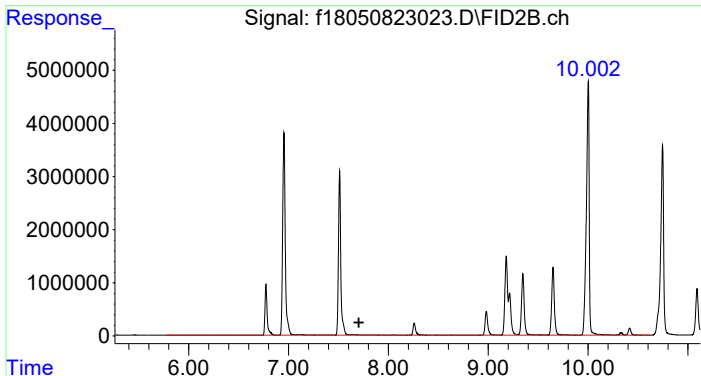

#9 > C8 to C10 Aromatics  
 R.T.: 7.704 min  
 Delta R.T.: 0.000 min  
 Response: 335466354  
 Conc: 282.30 UG/ML m

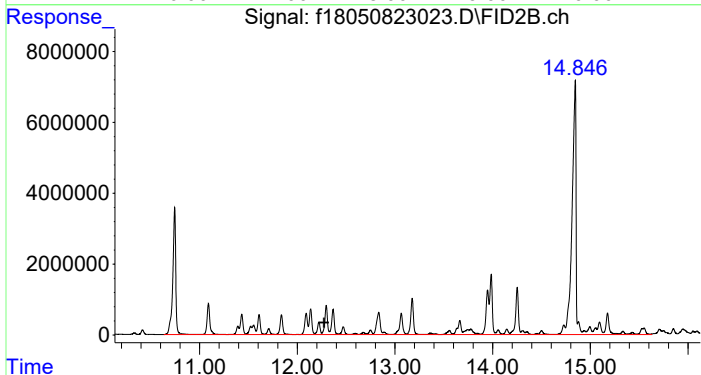

#10 > C10 to C12 Aromatics  
 R.T.: 12.274 min  
 Delta R.T.: 0.000 min  
 Response: 627409542  
 Conc: 527.97 UG/ML m

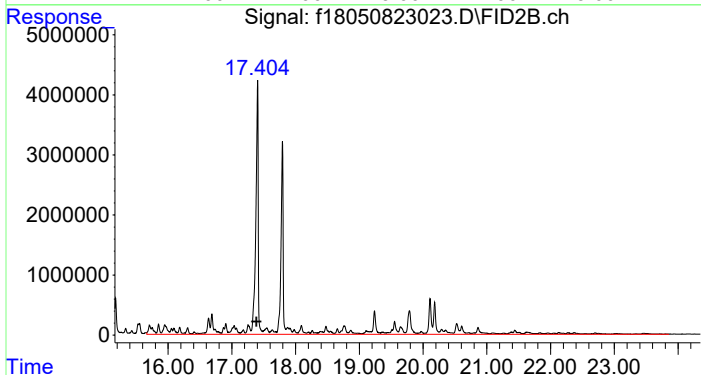

#11 > C12 to C16 Aromatics  
 R.T.: 17.385 min  
 Delta R.T.: 0.000 min  
 Response: 403184711  
 Conc: 339.28 UG/ML m

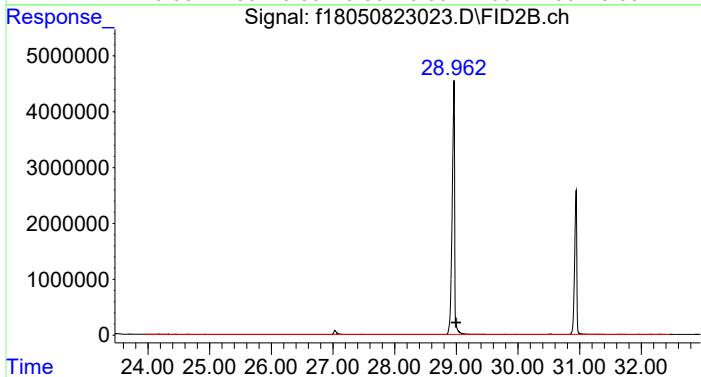

#12 > C16 to C21 Aromatics  
 R.T.: 28.995 min  
 Delta R.T.: 0.000 min  
 Response: 9718501  
 Conc: 8.18 UG/ML m

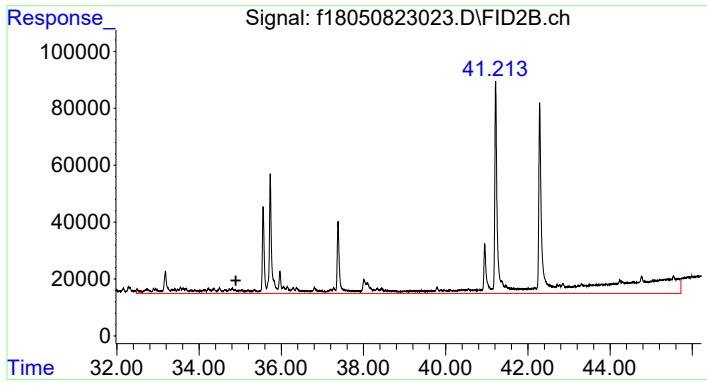

#13 > C21 to C32 Aromatics

R.T.: 34.889 min  
Delta R.T.: 0.000 min  
Response: 22850747  
Conc: 19.23 UG/ML m



Data Path : C:\Projects\Hawaii DOH\2. Laboratory Data\Alpha\WAF Study\L2317027\TPH\NF TPH\  
 Data File : f18042723051.D  
 Signal(s) : FID2B.ch  
 Acq On : 28 Apr 2023 08:46 pm  
 Operator : FID18:AMV  
 Sample : L2317027-10  
 Misc : WG1772069,WG1763893,ICAL19877  
 ALS Vial : 76 Sample Multiplier: 1

Integration File: SHCINT2.E  
 Quant Time: Jun 01 12:34:14 2023  
 Quant Method : C:\Projects\Hawaii DOH\2. Laboratory Data\Alpha\WAF Study\L2317027\TPH\NF TPH\NF T  
 .. PH Quant.M  
 Quant Title : FID Forensics  
 QLast Update : Fri Sep 23 15:53:13 2022  
 Response via : Initial Calibration  
 Integrator: ChemStation

Volume Inj. : 1.0  
 Signal Phase : Rtx-5MS  
 Signal Info : 0.25mm

Blank Name : IB1804272302R  
 Blank File : f18042723039.D

Compound	R.T.	Response	Conc Units
-----			
Internal Standards			
1) I 5-alpha-androstane	31.066	63333294	50.000 ug/mL m
System Monitoring Compounds			
2) s ortho-terphenyl	29.090	151685772	114.565 ug/mL m
Spiked Amount 50.000	Range 50 - 130	Recovery = 229.13%#	
3) s d50-Tetracosane	35.718	123097436	117.585 ug/mL m
Spiked Amount 50.000	Range 50 - 130	Recovery = 235.17%#	
Target Compounds			
4) h > C8 to C10 Aliphatics	8.012	732712422	614.065 ug/mL m
5) h > C10 to C12 Aliphatics	12.930	1077616213	903.119 ug/ml m
6) h > C12 to C16 Aliphatics	23.659	982209506	823.161 UG/ML m
7) h > C16 to C21 Aliphatics	28.995	106563557	89.308 UG/ML m
8) h > C21 to C32 Aliphatics	33.402	85189142	71.395 UG/ML m

SemiQuant Compounds - Not Calibrated on this Instrument

(f)=RT Delta > 1/2 Window

(m)=manual int.

Data Path : C:\Projects\Hawaii DOH\2. Laboratory Data\Alpha\WAF Study\L2317027\TPH\NF TPH\  
Data File : f18042723051.D  
Signal(s) : FID2B.ch  
Acq On : 28 Apr 2023 08:46 pm  
Operator : FID18:AMV  
Sample : L2317027-10  
Misc : WG1772069,WG1763893,ICAL19877  
ALS Vial : 76 Sample Multiplier: 1

Integration File: SHCINT2.E  
Quant Time: Jun 01 12:34:14 2023  
Quant Method : C:\Projects\Hawaii DOH\2. Laboratory Data\Alpha\WAF Study\L2317027\TPH\NF TPH\NF T  
... PH Quant.M  
Quant Title : FID Forensics  
QLast Update : Fri Sep 23 15:53:13 2022  
Response via : Initial Calibration  
Integrator: ChemStation

Volume Inj. : 1.0  
Signal Phase : Rtx-5MS  
Signal Info : 0.25mm

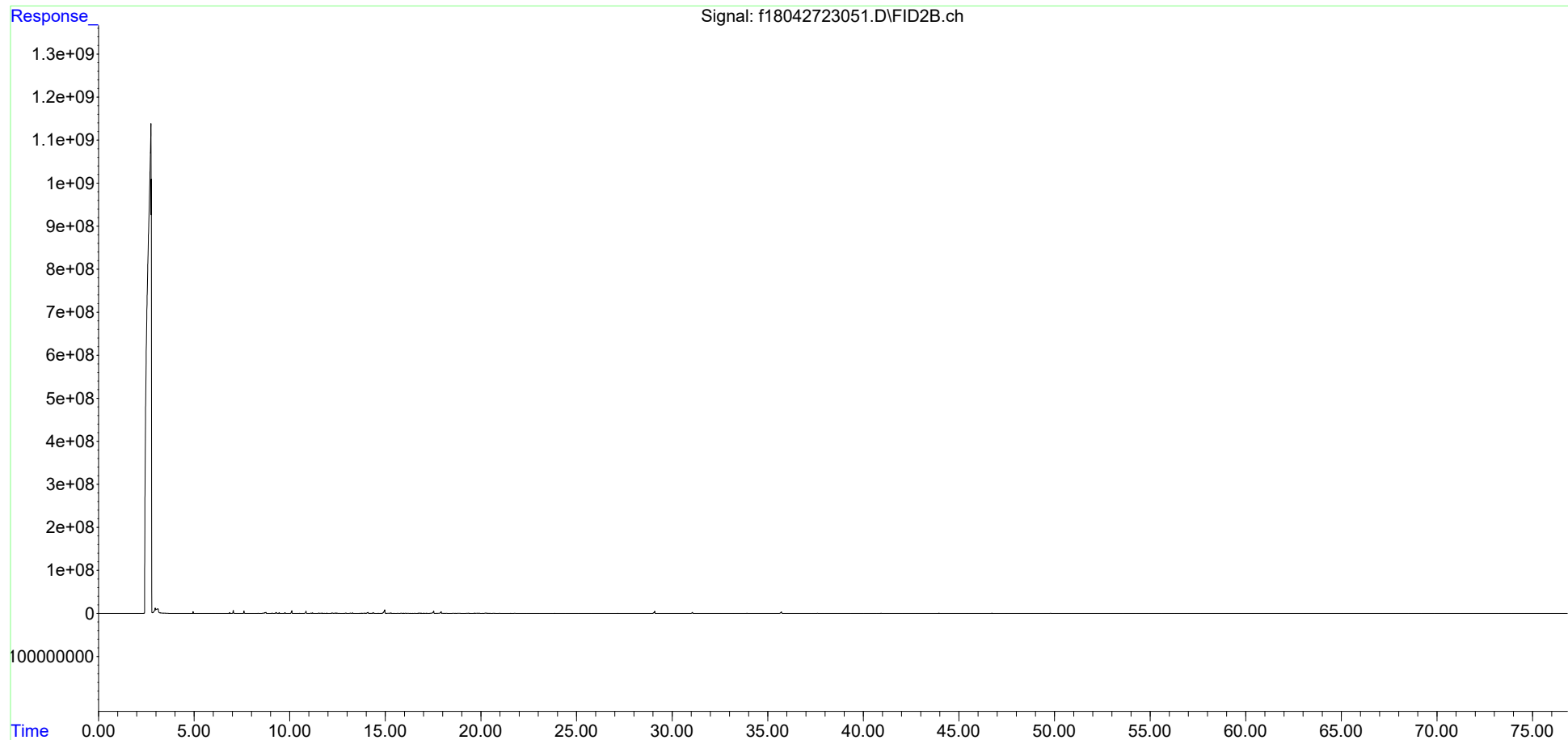

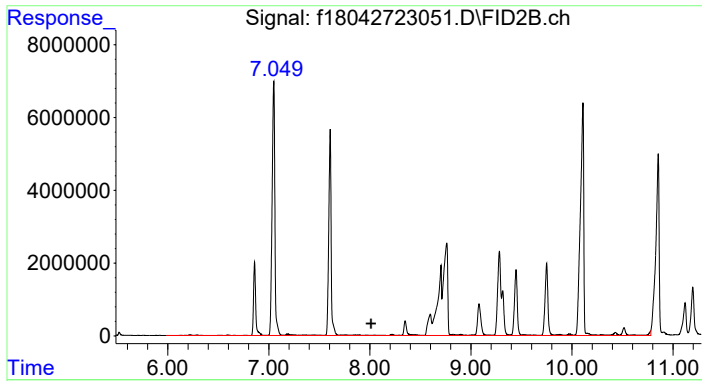

#4 > C8 to C10 Aliphatics  
 R.T.: 8.012 min  
 Delta R.T.: 0.000 min  
 Response: 732712422  
 Conc: 614.07 ug/mL m

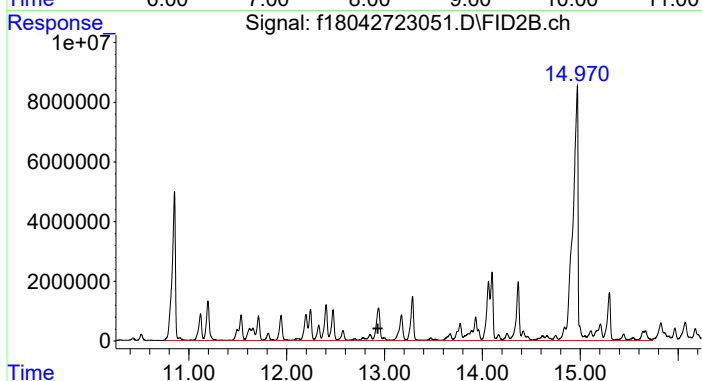

#5 > C10 to C12 Aliphatics  
 R.T.: 12.930 min  
 Delta R.T.: 0.000 min  
 Response: 1077616213  
 Conc: 903.12 ug/ml m

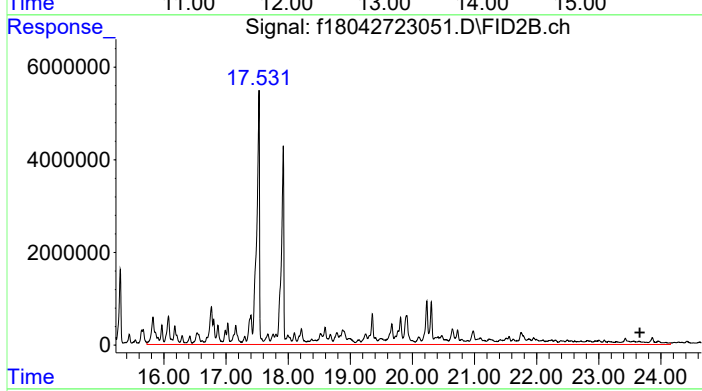

#6 > C12 to C16 Aliphatics  
 R.T.: 23.659 min  
 Delta R.T.: 0.000 min  
 Response: 982209506  
 Conc: 823.16 UG/ML m

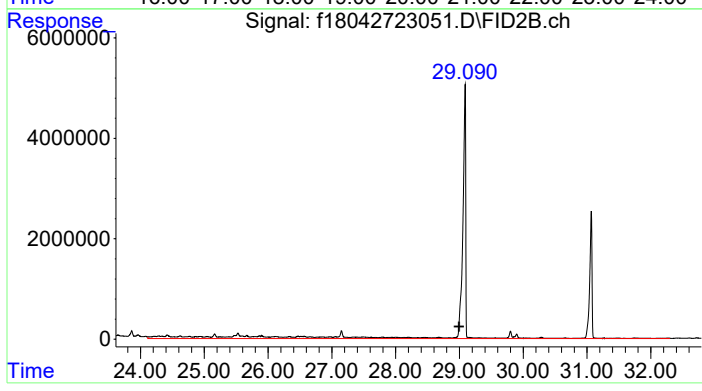

#7 > C16 to C21 Aliphatics  
 R.T.: 28.995 min  
 Delta R.T.: 0.000 min  
 Response: 106563557  
 Conc: 89.31 UG/ML m

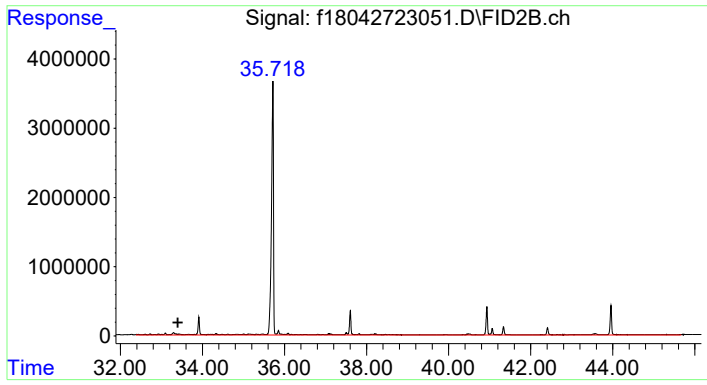

#8 > C21 to C32 Aliphatics

R.T.: 33.402 min  
Delta R.T.: 0.000 min  
Response: 85189142  
Conc: 71.39 UG/ML m

Data Path : C:\Projects\Hawaii DOH\2. Laboratory Data\Alpha\WAF Study\L2317027\TPH\NF TPH\  
 Data File : f18050523079.D  
 Signal(s) : FID2B.ch  
 Acq On : 07 May 2023 05:38 pm  
 Operator : FID18:AMV  
 Sample : L2317027-11F1  
 Misc : WG1775373,WG1771478,ICAL19877  
 ALS Vial : 90 Sample Multiplier: 1

Integration File: SHCINT2.E  
 Quant Time: May 31 16:06:48 2023  
 Quant Method : C:\Projects\Hawaii DOH\2. Laboratory Data\Alpha\WAF Study\L2317027\TPH\NF TPH\NF T  
 .. PH Quant.M  
 Quant Title : FID Forensics  
 QLast Update : Fri Sep 23 15:53:13 2022  
 Response via : Initial Calibration  
 Integrator: ChemStation

Volume Inj. : 1.0  
 Signal Phase : Rtx-5MS  
 Signal Info : 0.25mm

Blank Name : IB1805052303R  
 Blank File : f18050523061.D

Compound	R.T.	Response	Conc Units
-----			
Internal Standards			
1) I 5-alpha-androstane	30.943	65592857	50.000 ug/mL m
System Monitoring Compounds			
3) s d50-Tetracosane	35.606	124182264	114.535 ug/mL m
Spiked Amount 50.000	Range 50 - 130	Recovery	= 229.07%#
Target Compounds			
4) h > C8 to C10 Aliphatics	8.012	23621830	19.115 ug/mL m
5) h > C10 to C12 Aliphatics	12.930	6974380	5.644 ug/ml m
6) h > C12 to C16 Aliphatics	23.659	2624382	2.124 UG/ML m
7) h > C16 to C21 Aliphatics	28.995	2868998	2.322 UG/ML m
8) h > C21 to C32 Aliphatics	33.402	17407745	14.086 UG/ML m

SemiQuant Compounds - Not Calibrated on this Instrument

(f)=RT Delta > 1/2 Window

(m)=manual int.

Data Path : C:\Projects\Hawaii DOH\2. Laboratory Data\Alpha\WAF Study\L2317027\TPH\NF TPH\  
Data File : f18050523079.D  
Signal(s) : FID2B.ch  
Acq On : 07 May 2023 05:38 pm  
Operator : FID18:AMV  
Sample : L2317027-11F1  
Misc : WG1775373, WG1771478, ICAL19877  
ALS Vial : 90 Sample Multiplier: 1

Integration File: SHCINT2.E  
Quant Time: May 31 16:06:48 2023  
Quant Method : C:\Projects\Hawaii DOH\2. Laboratory Data\Alpha\WAF Study\L2317027\TPH\NF TPH\NF T  
PH Quant.M  
Quant Title : FID Forensics  
QLast Update : Fri Sep 23 15:53:13 2022  
Response via : Initial Calibration  
Integrator: ChemStation

Volume Inj. : 1.0  
Signal Phase : Rtx-5MS  
Signal Info : 0.25mm

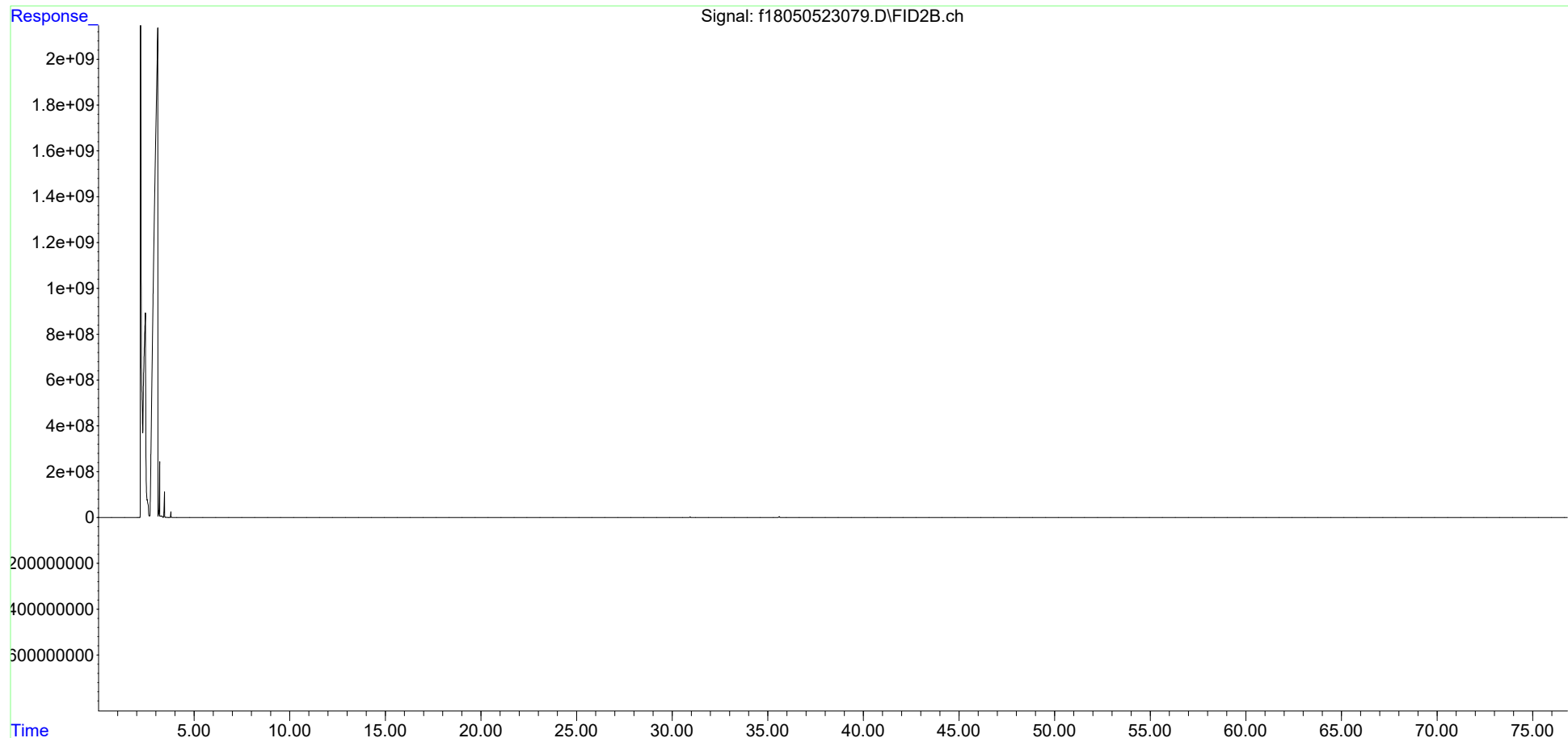

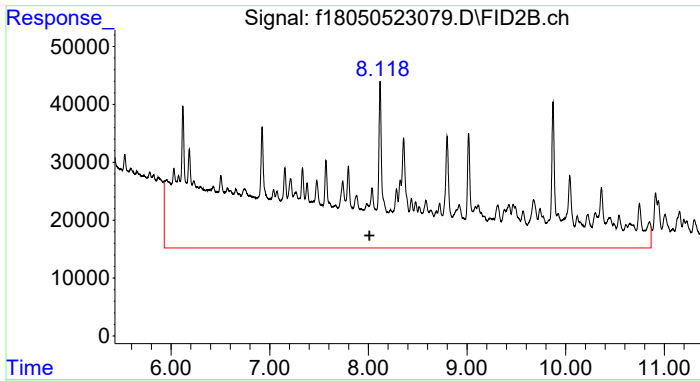

#4 > C8 to C10 Aliphatics

R.T.: 8.012 min  
 Delta R.T.: 0.000 min  
 Response: 23621830  
 Conc: 19.11 ug/mL m

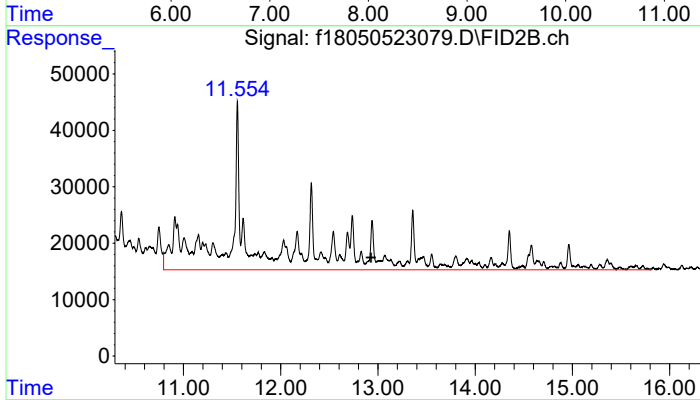

#5 > C10 to C12 Aliphatics

R.T.: 12.930 min  
 Delta R.T.: 0.000 min  
 Response: 6974380  
 Conc: 5.64 ug/ml m

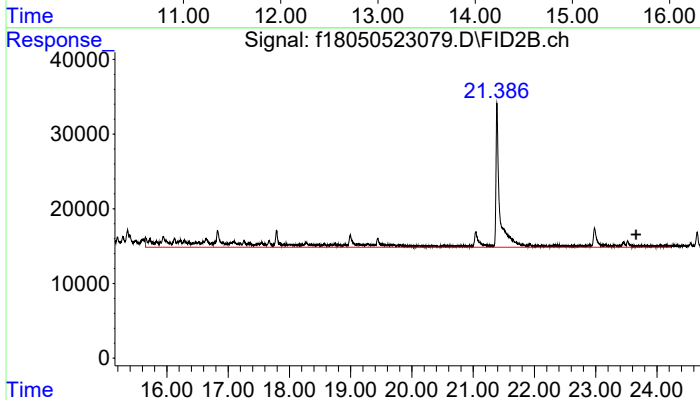

#6 > C12 to C16 Aliphatics

R.T.: 23.659 min  
 Delta R.T.: 0.000 min  
 Response: 2624382  
 Conc: 2.12 UG/ML m

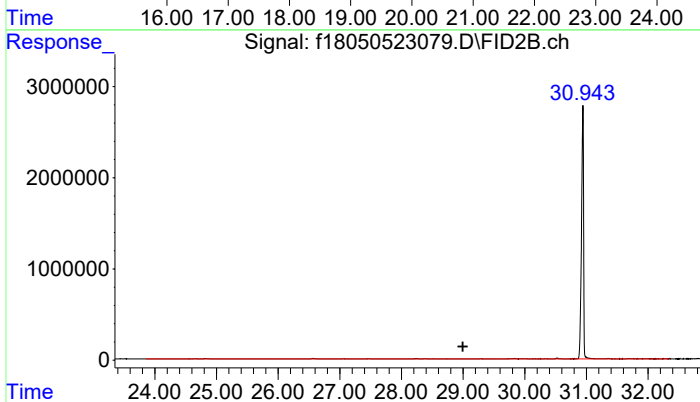

#7 > C16 to C21 Aliphatics

R.T.: 28.995 min  
 Delta R.T.: 0.000 min  
 Response: 2868998  
 Conc: 2.32 UG/ML m

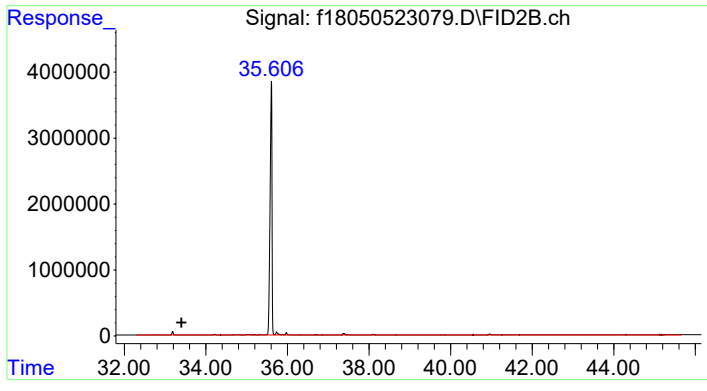

#8 > C21 to C32 Aliphatics

R.T.: 33.402 min  
Delta R.T.: 0.000 min  
Response: 17407745  
Conc: 14.09 UG/ML m



Data Path : C:\Projects\Hawaii DOH\2. Laboratory Data\Alpha\WAF Study\L2317027\TPH\NF TPH\  
 Data File : f18050823025.D  
 Signal(s) : FID2B.ch  
 Acq On : 09 May 2023 02:02 am  
 Operator : FID18:AMV  
 Sample : L2317027-12F2  
 Misc : WG1776333,WG1771479,ICAL19877  
 ALS Vial : 63 Sample Multiplier: 1

Integration File: SHCINT2.E  
 Quant Time: Jun 01 10:38:43 2023  
 Quant Method : C:\Projects\Hawaii DOH\2. Laboratory Data\Alpha\WAF Study\L2317027\TPH\NF TPH\NF T  
 .. PH Quant.M  
 Quant Title : FID Forensics  
 QLast Update : Fri Sep 23 15:53:13 2022  
 Response via : Initial Calibration  
 Integrator: ChemStation

Volume Inj. : 1.0  
 Signal Phase : Rtx-5MS  
 Signal Info : 0.25mm

Blank Name : IB1805082301R  
 Blank File : f18050823009.D

Compound	R.T.	Response	Conc Units
-----			
Internal Standards			
1) I 5-alpha-androstane	30.945	73178707	50.000 ug/mL m
System Monitoring Compounds			
2) s ortho-terphenyl	28.965	136421856	89.174 ug/mL m
Spiked Amount 50.000	Range 50 - 130	Recovery =	178.35%#
Target Compounds			
9) h > C8 to C10 Aromatics	7.704	380501948	275.985 UG/ML m
10) h > C10 to C12 Aromatics	12.274	720576743	522.647 UG/ML m
11) h > C12 to C16 Aromatics	17.385	467681735	339.218 UG/ML m
12) h > C16 to C21 Aromatics	28.995	13123106	9.518 UG/ML m
13) h > C21 to C32 Aromatics	34.889	26258839	19.046 UG/ML m

SemiQuant Compounds - Not Calibrated on this Instrument

(f)=RT Delta > 1/2 Window

(m)=manual int.

Data Path : C:\Projects\Hawaii DOH\2. Laboratory Data\Alpha\WAF Study\L2317027\TPH\NF TPH\  
Data File : f18050823025.D  
Signal(s) : FID2B.ch  
Acq On : 09 May 2023 02:02 am  
Operator : FID18:AMV  
Sample : L2317027-12F2  
Misc : WG1776333,WG1771479,ICAL19877  
ALS Vial : 63 Sample Multiplier: 1

Integration File: SHCINT2.E  
Quant Time: Jun 01 10:38:43 2023  
Quant Method : C:\Projects\Hawaii DOH\2. Laboratory Data\Alpha\WAF Study\L2317027\TPH\NF TPH\NF T  
... PH Quant.M  
Quant Title : FID Forensics  
QLast Update : Fri Sep 23 15:53:13 2022  
Response via : Initial Calibration  
Integrator: ChemStation

Volume Inj. : 1.0  
Signal Phase : Rtx-5MS  
Signal Info : 0.25mm

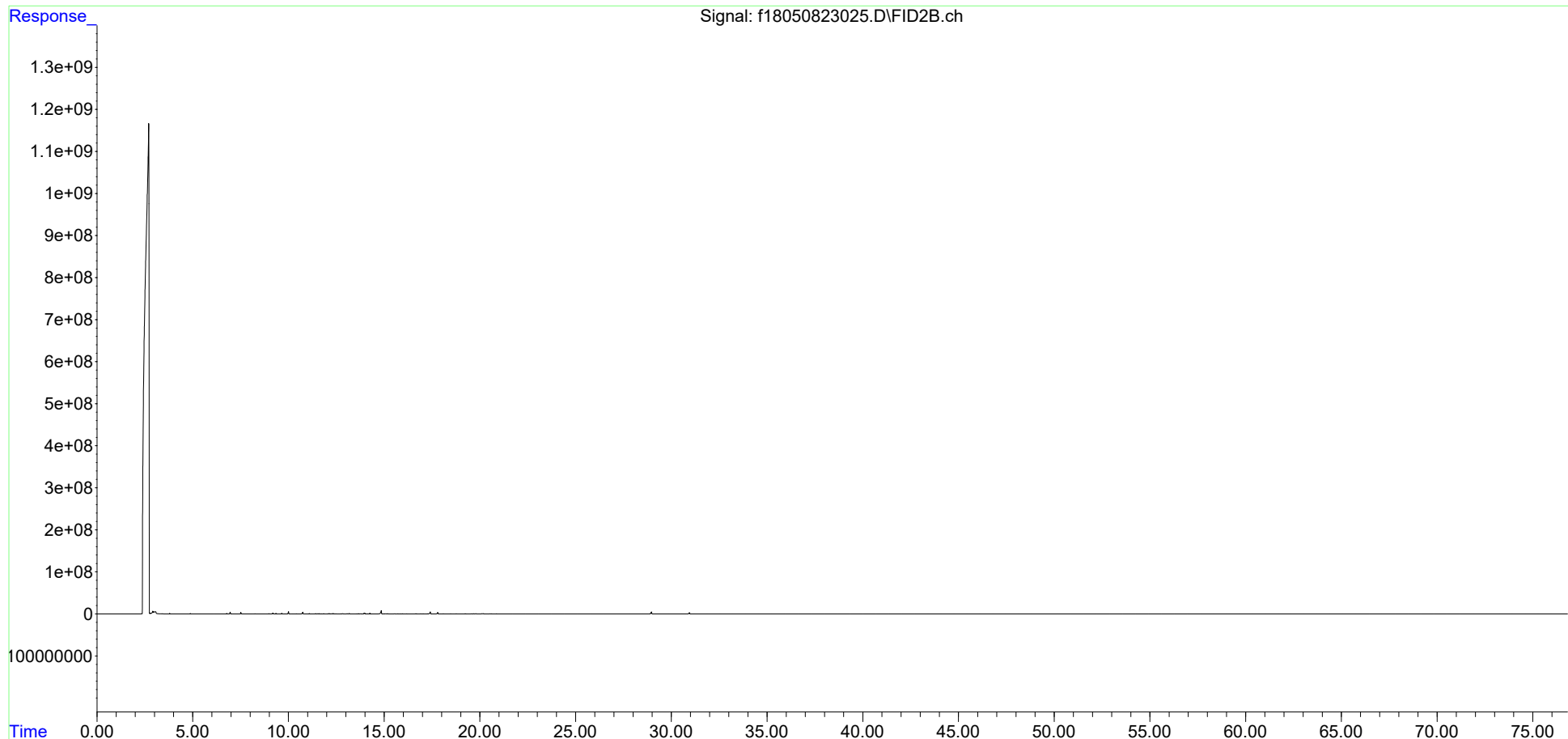

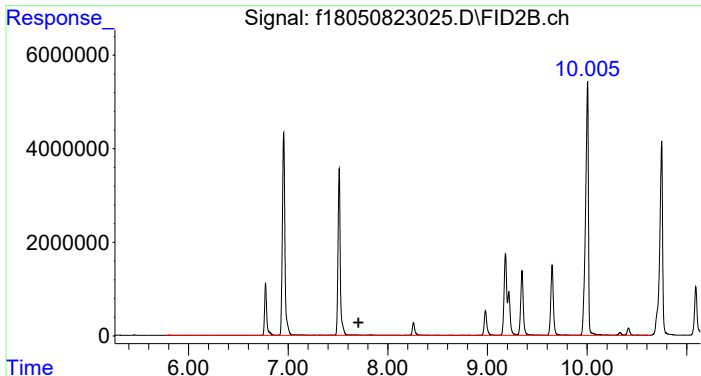

#9 > C8 to C10 Aromatics  
 R.T.: 7.704 min  
 Delta R.T.: 0.000 min  
 Response: 380501948  
 Conc: 275.98 UG/ML m

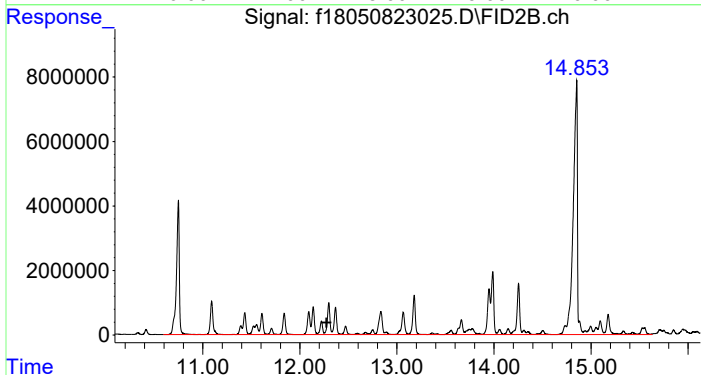

#10 > C10 to C12 Aromatics  
 R.T.: 12.274 min  
 Delta R.T.: 0.000 min  
 Response: 720576743  
 Conc: 522.65 UG/ML m

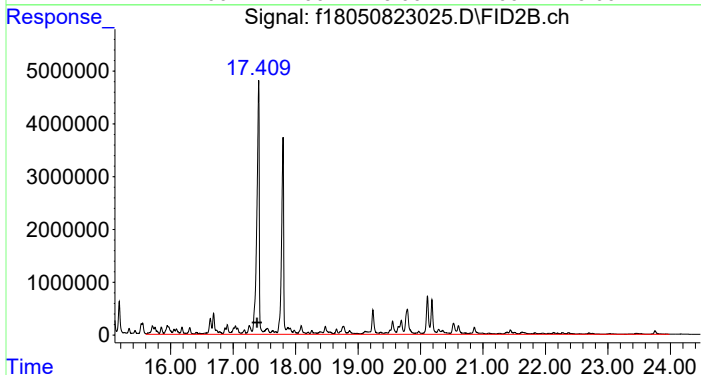

#11 > C12 to C16 Aromatics  
 R.T.: 17.385 min  
 Delta R.T.: 0.000 min  
 Response: 467681735  
 Conc: 339.22 UG/ML m

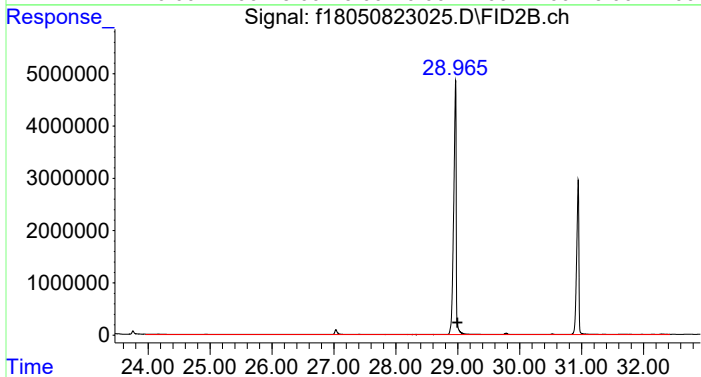

#12 > C16 to C21 Aromatics  
 R.T.: 28.995 min  
 Delta R.T.: 0.000 min  
 Response: 13123106  
 Conc: 9.52 UG/ML m

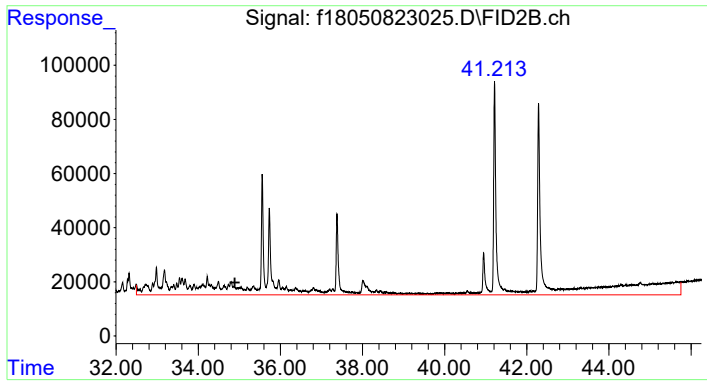

#13 > C21 to C32 Aromatics

R.T.: 34.889 min  
Delta R.T.: 0.000 min  
Response: 26258839  
Conc: 19.05 UG/ML m

Data Path : C:\Projects\Hawaii DOH\2. Laboratory Data\Alpha\WAF Study\L2317027\TPH\NF TPH\  
 Data File : f18042723059.D  
 Signal(s) : FID2B.ch  
 Acq On : 29 Apr 2023 02:21 am  
 Operator : FID18:AMV  
 Sample : L2317027-13  
 Misc : WG1772069,WG1767601,ICAL19877  
 ALS Vial : 80 Sample Multiplier: 1

Integration File: SHCINT2.E

Quant Time: Jun 01 12:49:22 2023

Quant Method : C:\Projects\Hawaii DOH\2. Laboratory Data\Alpha\WAF Study\L2317027\TPH\NF TPH\NF T  
 PH Quant.M

Quant Title : FID Forensics

QLast Update : Fri Sep 23 15:53:13 2022

Response via : Initial Calibration

Integrator: ChemStation

Volume Inj. : 1.0

Signal Phase : Rtx-5MS

Signal Info : 0.25mm

Blank Name : IB1804272302R

Blank File : f18042723039.D

Compound	R.T.	Response	Conc Units
Internal Standards			
1) I 5-alpha-androstane	31.069	70510259	50.000 ug/mL m
System Monitoring Compounds			
2) s ortho-terphenyl	29.094	170638769	115.762 ug/mL m
Spiked Amount 50.000	Range 50 - 130	Recovery = 231.52%#	
3) s d50-Tetracosane	35.720	139273749	119.496 ug/mL m
Spiked Amount 50.000	Range 50 - 130	Recovery = 238.99%#	
Target Compounds			
4) h > C8 to C10 Aliphatics	8.012	757971523	570.576 ug/mL m
5) h > C10 to C12 Aliphatics	12.930	1301920969	980.043 ug/ml m
6) h > C12 to C16 Aliphatics	23.659	1180760750	888.838 UG/ML m
7) h > C16 to C21 Aliphatics	28.995	107200560	80.697 UG/ML m
8) h > C21 to C32 Aliphatics	33.402	38747693	29.168 UG/ML m

SemiQuant Compounds - Not Calibrated on this Instrument

(f)=RT Delta > 1/2 Window

(m)=manual int.

Data Path : C:\Projects\Hawaii DOH\2. Laboratory Data\Alpha\WAF Study\L2317027\TPH\NF TPH\  
Data File : f18042723059.D  
Signal(s) : FID2B.ch  
Acq On : 29 Apr 2023 02:21 am  
Operator : FID18:AMV  
Sample : L2317027-13  
Misc : WG1772069,WG1767601,ICAL19877  
ALS Vial : 80 Sample Multiplier: 1

Integration File: SHCINT2.E  
Quant Time: Jun 01 12:49:22 2023  
Quant Method : C:\Projects\Hawaii DOH\2. Laboratory Data\Alpha\WAF Study\L2317027\TPH\NF TPH\NF T  
... PH Quant.M  
Quant Title : FID Forensics  
QLast Update : Fri Sep 23 15:53:13 2022  
Response via : Initial Calibration  
Integrator: ChemStation

Volume Inj. : 1.0  
Signal Phase : Rtx-5MS  
Signal Info : 0.25mm

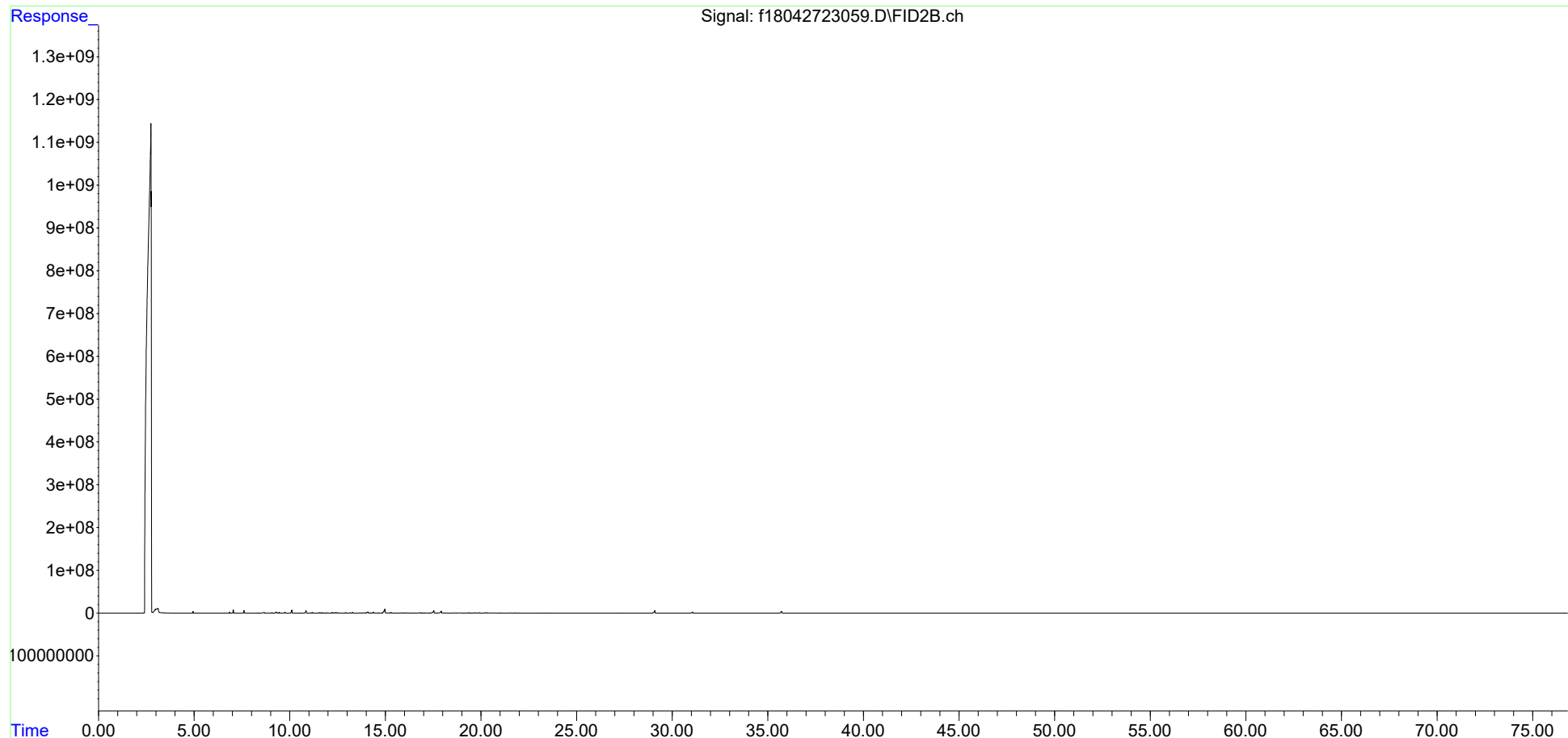

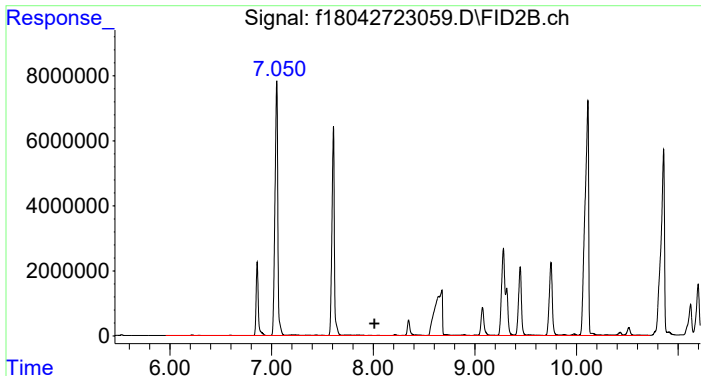

#4 > C8 to C10 Aliphatics

R.T.: 8.012 min  
 Delta R.T.: 0.000 min  
 Response: 757971523  
 Conc: 570.58 ug/mL m

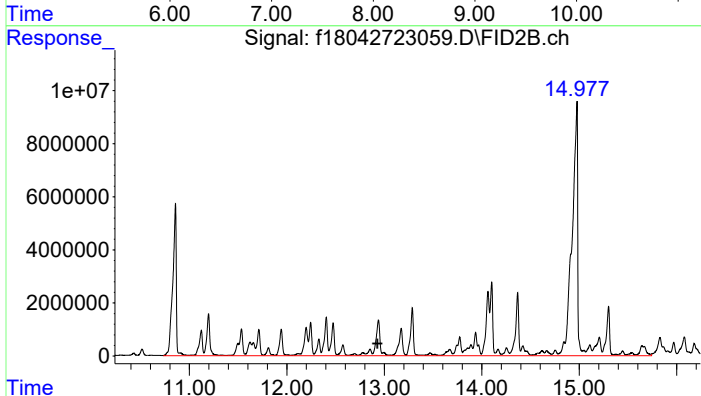

#5 > C10 to C12 Aliphatics

R.T.: 12.930 min  
 Delta R.T.: 0.000 min  
 Response: 1301920969  
 Conc: 980.04 ug/ml m

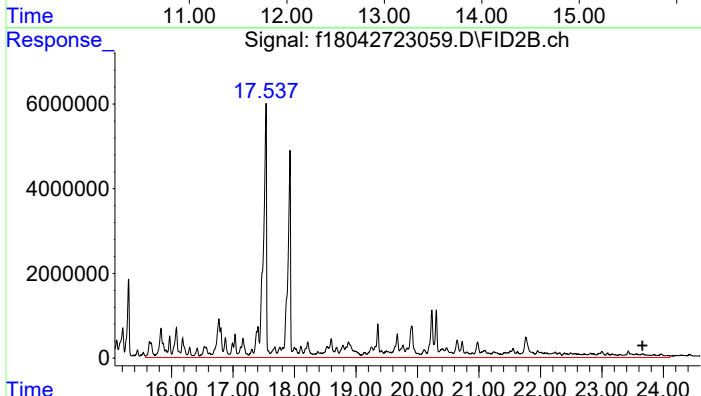

#6 > C12 to C16 Aliphatics

R.T.: 23.659 min  
 Delta R.T.: 0.000 min  
 Response: 1180760750  
 Conc: 888.84 UG/ML m

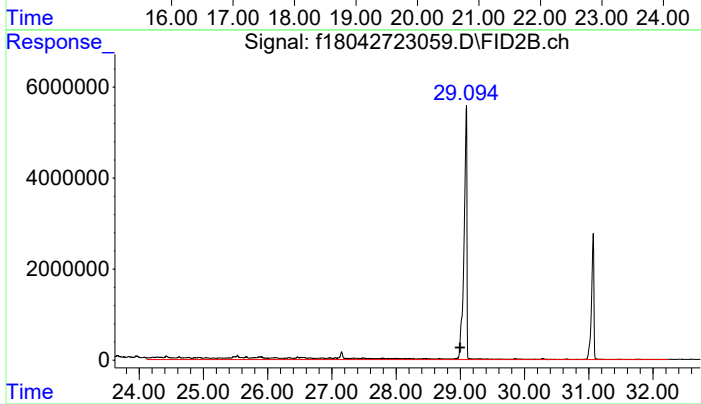

#7 > C16 to C21 Aliphatics

R.T.: 28.995 min  
 Delta R.T.: 0.000 min  
 Response: 107200560  
 Conc: 80.70 UG/ML m

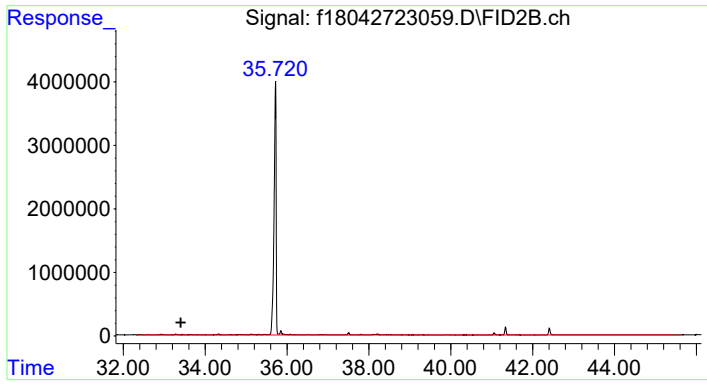

#8 > C21 to C32 Aliphatics

R.T.: 33.402 min  
Delta R.T.: 0.000 min  
Response: 38747693  
Conc: 29.17 UG/ML m



Data Path : C:\Projects\Hawaii DOH\2. Laboratory Data\Alpha\WAF Study\L2317027\TPH\NF TPH\  
 Data File : f18050523081.D  
 Signal(s) : FID2B.ch  
 Acq On : 07 May 2023 07:02 pm  
 Operator : FID18:AMV  
 Sample : L2317027-14F1  
 Misc : WG1775373,WG1771480,ICAL19877  
 ALS Vial : 91 Sample Multiplier: 1

Integration File: SHCINT2.E  
 Quant Time: May 31 16:10:30 2023  
 Quant Method : C:\Projects\Hawaii DOH\2. Laboratory Data\Alpha\WAF Study\L2317027\TPH\NF TPH\NF T  
 .. PH Quant.M  
 Quant Title : FID Forensics  
 QLast Update : Fri Sep 23 15:53:13 2022  
 Response via : Initial Calibration  
 Integrator: ChemStation

Volume Inj. : 1.0  
 Signal Phase : Rtx-5MS  
 Signal Info : 0.25mm

Blank Name : IB1805052303R  
 Blank File : f18050523061.D

Compound	R.T.	Response	Conc Units
-----			
Internal Standards			
1) I 5-alpha-androstane	30.943	64810636	50.000 ug/mL m
System Monitoring Compounds			
3) s d50-Tetracosane	35.606	122924998	114.744 ug/mL m
Spiked Amount 50.000	Range 50 - 130	Recovery	= 229.49%#
Target Compounds			
4) h > C8 to C10 Aliphatics	8.012	7393406	6.055 ug/mL m
5) h > C10 to C12 Aliphatics	12.930	4913285	4.024 ug/ml m
6) h > C12 to C16 Aliphatics	23.659	2662702	2.181 UG/ML m
7) h > C16 to C21 Aliphatics	28.995	2712442	2.221 UG/ML m
8) h > C21 to C32 Aliphatics	33.402	18481976	15.136 UG/ML m

SemiQuant Compounds - Not Calibrated on this Instrument

(f)=RT Delta > 1/2 Window

(m)=manual int.

Data Path : C:\Projects\Hawaii DOH\2. Laboratory Data\Alpha\WAF Study\L2317027\TPH\NF TPH\  
Data File : f18050523081.D  
Signal(s) : FID2B.ch  
Acq On : 07 May 2023 07:02 pm  
Operator : FID18:AMV  
Sample : L2317027-14F1  
Misc : WG1775373,WG1771480,ICAL19877  
ALS Vial : 91 Sample Multiplier: 1

Integration File: SHCINT2.E  
Quant Time: May 31 16:10:30 2023  
Quant Method : C:\Projects\Hawaii DOH\2. Laboratory Data\Alpha\WAF Study\L2317027\TPH\NF TPH\NF T  
... PH Quant.M  
Quant Title : FID Forensics  
QLast Update : Fri Sep 23 15:53:13 2022  
Response via : Initial Calibration  
Integrator: ChemStation

Volume Inj. : 1.0  
Signal Phase : Rtx-5MS  
Signal Info : 0.25mm

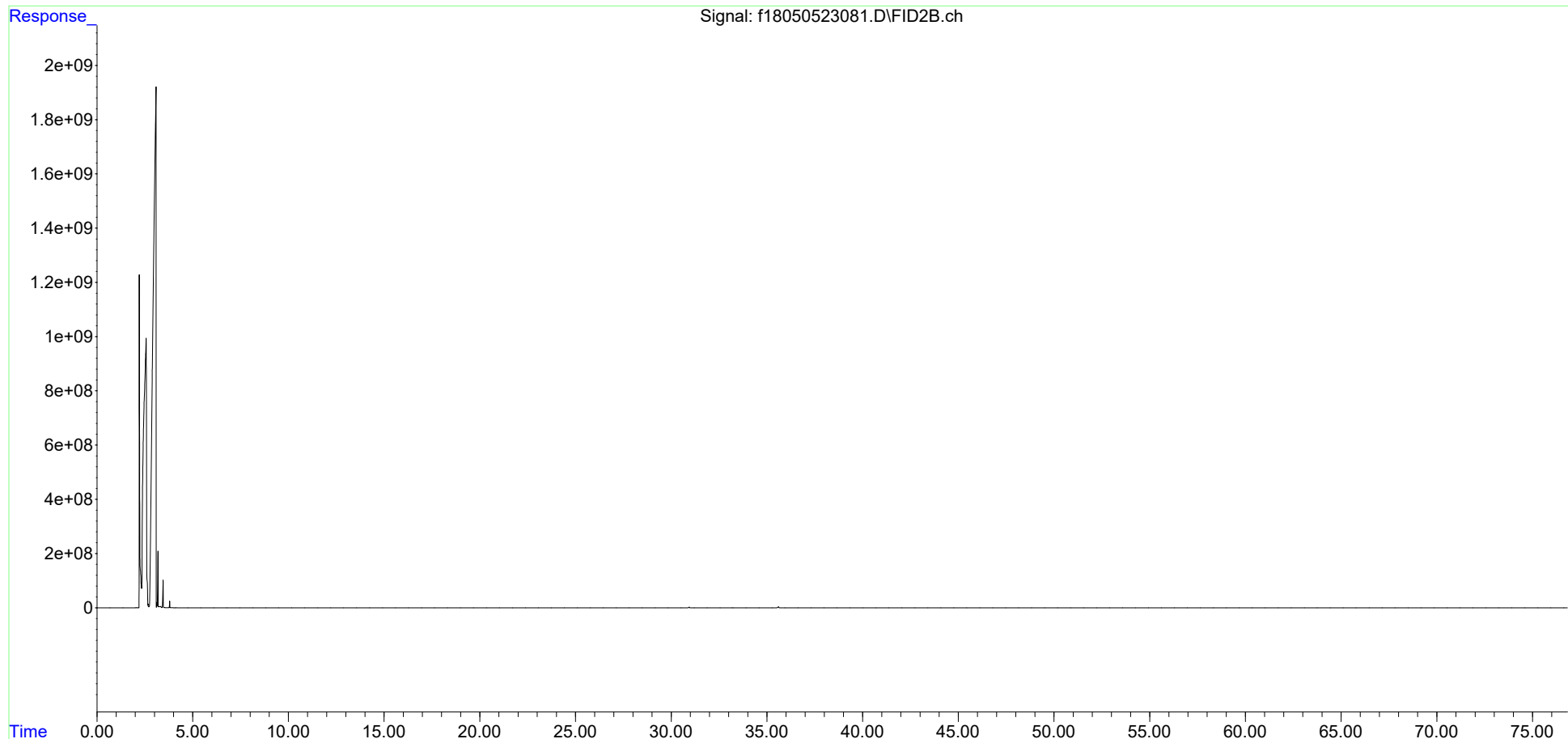

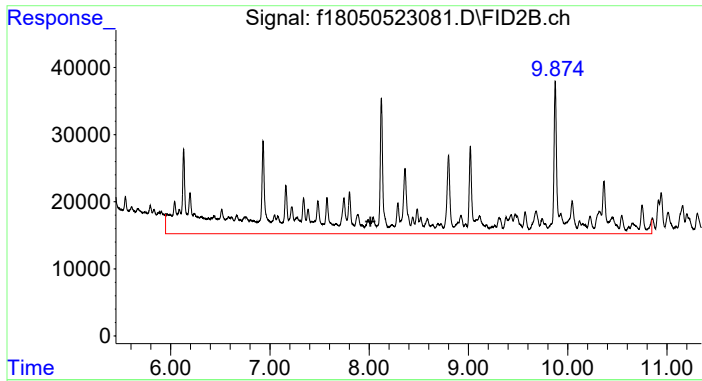

#4 > C8 to C10 Aliphatics

R.T.: 8.012 min  
 Delta R.T.: 0.000 min  
 Response: 7393406  
 Conc: 6.05 ug/mL m

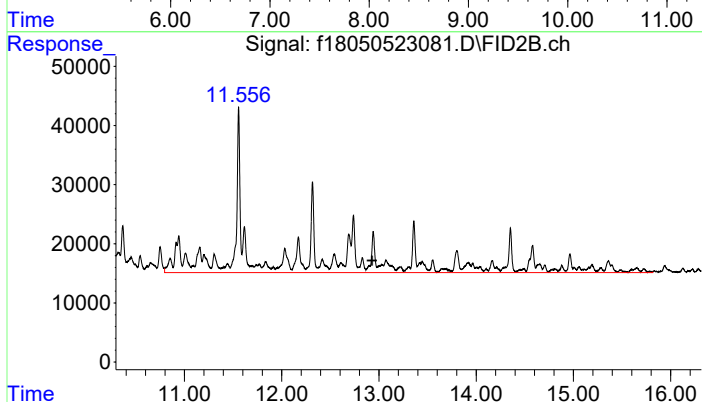

#5 > C10 to C12 Aliphatics

R.T.: 12.930 min  
 Delta R.T.: 0.000 min  
 Response: 4913285  
 Conc: 4.02 ug/ml m

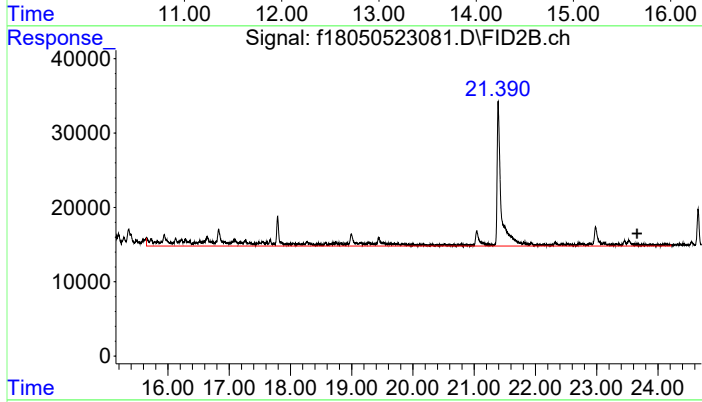

#6 > C12 to C16 Aliphatics

R.T.: 23.659 min  
 Delta R.T.: 0.000 min  
 Response: 2662702  
 Conc: 2.18 UG/ML m

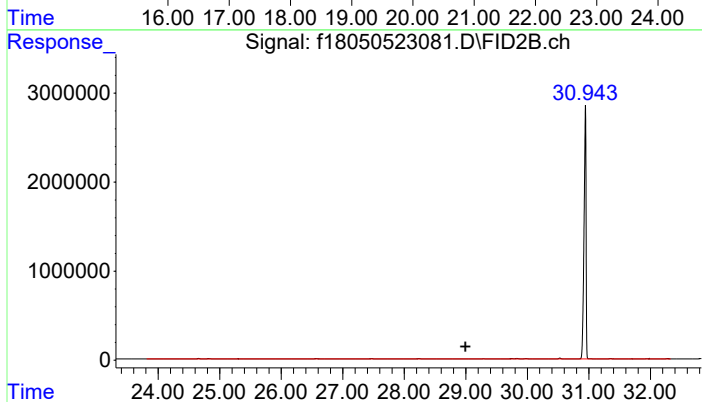

#7 > C16 to C21 Aliphatics

R.T.: 28.995 min  
 Delta R.T.: 0.000 min  
 Response: 2712442  
 Conc: 2.22 UG/ML m

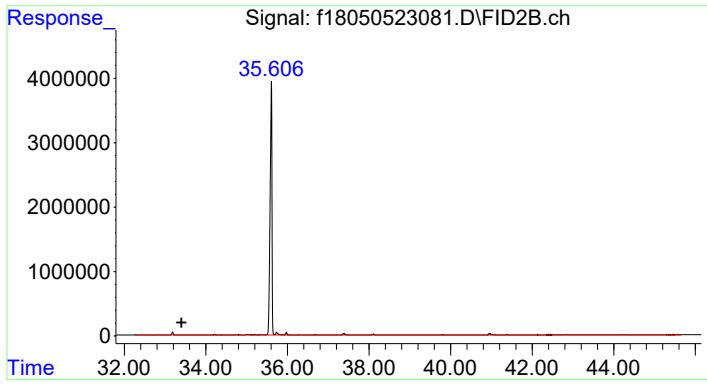

#8 > C21 to C32 Aliphatics

R.T.: 33.402 min  
Delta R.T.: 0.000 min  
Response: 18481976  
Conc: 15.14 UG/ML m

Data Path : C:\Projects\Hawaii DOH\2. Laboratory Data\Alpha\WAF Study\L2317027\TPH\NF TPH\  
 Data File : f18050823027.D  
 Signal(s) : FID2B.ch  
 Acq On : 09 May 2023 03:26 am  
 Operator : FID18:AMV  
 Sample : L2317027-15F2  
 Misc : WG1776333,WG1771481,ICAL19877  
 ALS Vial : 64 Sample Multiplier: 1

Integration File: SHCINT2.E  
 Quant Time: Jun 01 10:40:06 2023  
 Quant Method : C:\Projects\Hawaii DOH\2. Laboratory Data\Alpha\WAF Study\L2317027\TPH\NF TPH\NF T  
 .. PH Quant.M  
 Quant Title : FID Forensics  
 QLast Update : Fri Sep 23 15:53:13 2022  
 Response via : Initial Calibration  
 Integrator: ChemStation

Volume Inj. : 1.0  
 Signal Phase : Rtx-5MS  
 Signal Info : 0.25mm

Blank Name : IB1805082301R  
 Blank File : f18050823009.D

Compound	R.T.	Response	Conc Units
-----			
Internal Standards			
1) I 5-alpha-androstane	30.940	66742796	50.000 ug/mL m
System Monitoring Compounds			
2) s ortho-terphenyl	28.963	141573689	101.465 ug/mL m
Spiked Amount 50.000	Range 50 - 130	Recovery	= 202.93%#
Target Compounds			
9) h > C8 to C10 Aromatics	7.704	425692440	338.536 UG/ML m
10) h > C10 to C12 Aromatics	12.274	831701635	661.418 UG/ML m
11) h > C12 to C16 Aromatics	17.385	554518296	440.986 UG/ML m
12) h > C16 to C21 Aromatics	28.995	10982061	8.734 UG/ML m
13) h > C21 to C32 Aromatics	34.889	20066385	15.958 UG/ML m

SemiQuant Compounds - Not Calibrated on this Instrument

(f)=RT Delta > 1/2 Window

(m)=manual int.

Data Path : C:\Projects\Hawaii DOH\2. Laboratory Data\Alpha\WAF Study\L2317027\TPH\NF TPH\  
Data File : f18050823027.D  
Signal(s) : FID2B.ch  
Acq On : 09 May 2023 03:26 am  
Operator : FID18:AMV  
Sample : L2317027-15F2  
Misc : WG1776333,WG1771481,ICAL19877  
ALS Vial : 64 Sample Multiplier: 1

Integration File: SHCINT2.E  
Quant Time: Jun 01 10:40:06 2023  
Quant Method : C:\Projects\Hawaii DOH\2. Laboratory Data\Alpha\WAF Study\L2317027\TPH\NF TPH\NF T  
... PH Quant.M  
Quant Title : FID Forensics  
QLast Update : Fri Sep 23 15:53:13 2022  
Response via : Initial Calibration  
Integrator: ChemStation

Volume Inj. : 1.0  
Signal Phase : Rtx-5MS  
Signal Info : 0.25mm

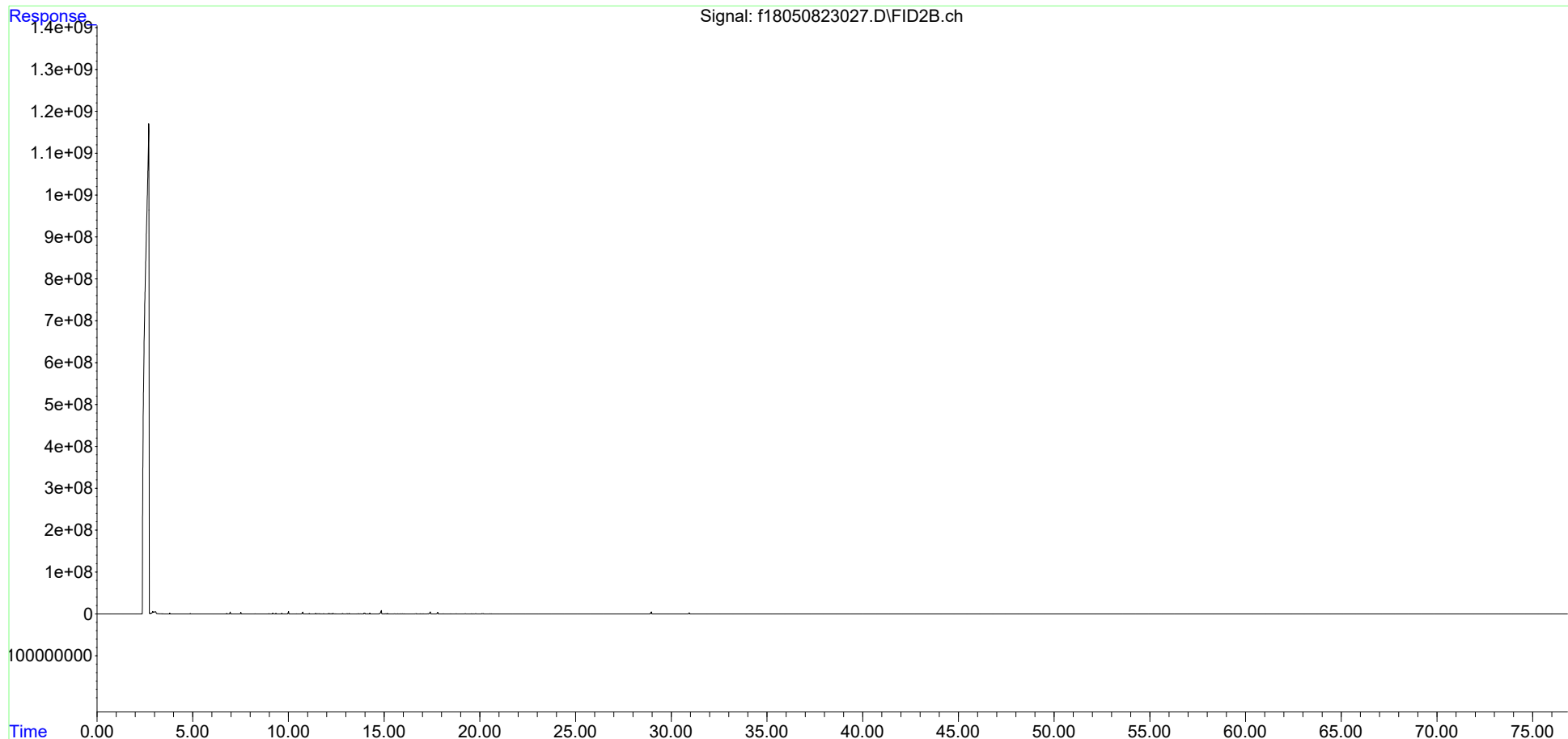

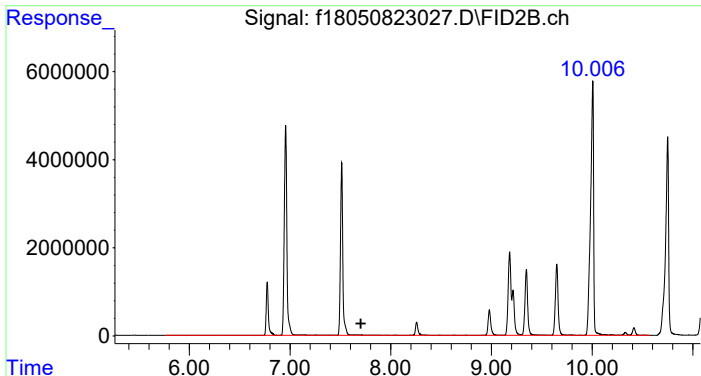

#9 > C8 to C10 Aromatics  
 R.T.: 7.704 min  
 Delta R.T.: 0.000 min  
 Response: 425692440  
 Conc: 338.54 UG/ML m

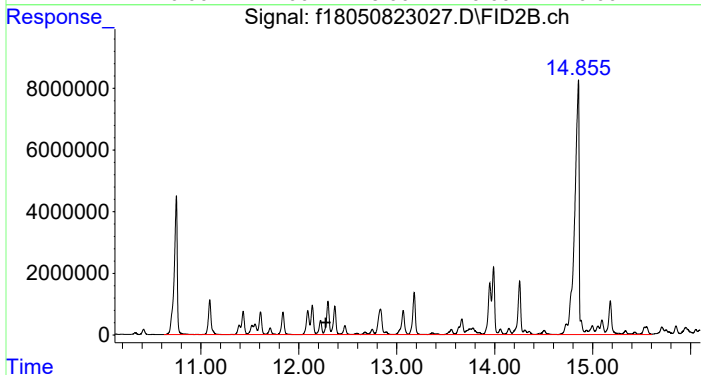

#10 > C10 to C12 Aromatics  
 R.T.: 12.274 min  
 Delta R.T.: 0.000 min  
 Response: 831701635  
 Conc: 661.42 UG/ML m

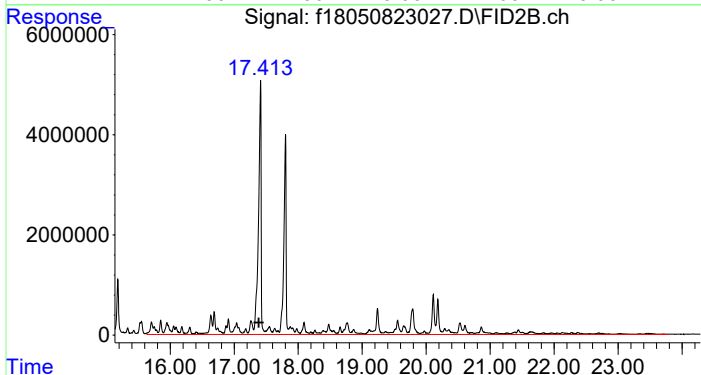

#11 > C12 to C16 Aromatics  
 R.T.: 17.385 min  
 Delta R.T.: 0.000 min  
 Response: 554518296  
 Conc: 440.99 UG/ML m

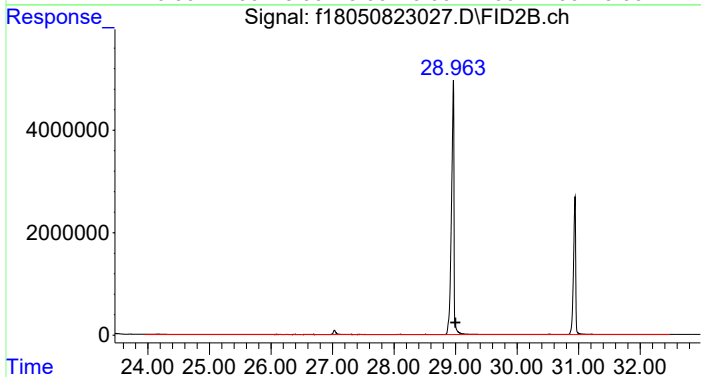

#12 > C16 to C21 Aromatics  
 R.T.: 28.995 min  
 Delta R.T.: 0.000 min  
 Response: 10982061  
 Conc: 8.73 UG/ML m

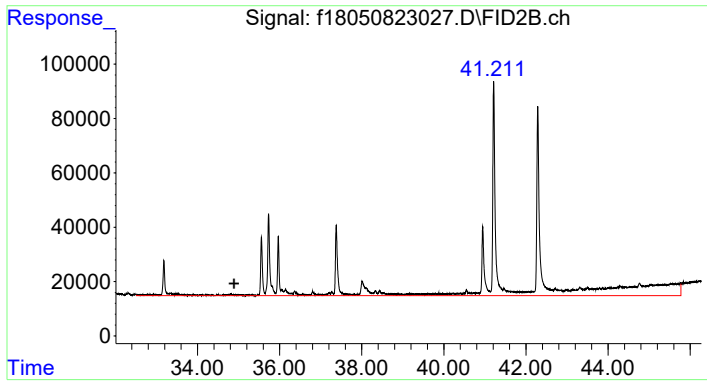

#13 > C21 to C32 Aromatics

R.T.: 34.889 min  
Delta R.T.: 0.000 min  
Response: 20066385  
Conc: 15.96 UG/ML m



Data Path : C:\Projects\Hawaii DOH\2. Laboratory Data\Alpha\WAF Study\L2317027\TPH\NF TPH\  
 Data File : f18042723061.D  
 Signal(s) : FID2B.ch  
 Acq On : 29 Apr 2023 03:45 am  
 Operator : FID18:AMV  
 Sample : L2317027-16  
 Misc : WG1772069,WG1767601,ICAL19877  
 ALS Vial : 81 Sample Multiplier: 1

Integration File: SHCINT2.E  
 Quant Time: Jun 01 12:54:15 2023  
 Quant Method : C:\Projects\Hawaii DOH\2. Laboratory Data\Alpha\WAF Study\L2317027\TPH\NF TPH\NF T  
 .. PH Quant.M  
 Quant Title : FID Forensics  
 QLast Update : Fri Sep 23 15:53:13 2022  
 Response via : Initial Calibration  
 Integrator: ChemStation

Volume Inj. : 1.0  
 Signal Phase : Rtx-5MS  
 Signal Info : 0.25mm

Blank Name : IB1804272302R  
 Blank File : f18042723039.D

Compound	R.T.	Response	Conc Units
-----			
Internal Standards			
1) I 5-alpha-androstane	31.073	75470006	50.000 ug/mL m
System Monitoring Compounds			
2) s ortho-terphenyl	29.096	158951192	100.746 ug/mL m
Spiked Amount 50.000	Range 50 - 130	Recovery = 201.49%#	
3) s d50-Tetracosane	35.723	130854466	104.894 ug/mL m
Spiked Amount 50.000	Range 50 - 130	Recovery = 209.79%#	
Target Compounds			
4) h > C8 to C10 Aliphatics	8.012	822815139	578.683 ug/mL m
5) h > C10 to C12 Aliphatics	12.930	1223296441	860.340 ug/ml m
6) h > C12 to C16 Aliphatics	23.659	1045437012	735.252 UG/ML m
7) h > C16 to C21 Aliphatics	28.995	117512309	82.646 UG/ML m
8) h > C21 to C32 Aliphatics	33.402	94251643	66.287 UG/ML m

SemiQuant Compounds - Not Calibrated on this Instrument

(f)=RT Delta > 1/2 Window

(m)=manual int.

Data Path : C:\Projects\Hawaii DOH\2. Laboratory Data\Alpha\WAF Study\L2317027\TPH\NF TPH\  
Data File : f18042723061.D  
Signal(s) : FID2B.ch  
Acq On : 29 Apr 2023 03:45 am  
Operator : FID18:AMV  
Sample : L2317027-16  
Misc : WG1772069,WG1767601,ICAL19877  
ALS Vial : 81 Sample Multiplier: 1

Integration File: SHCINT2.E  
Quant Time: Jun 01 12:54:15 2023  
Quant Method : C:\Projects\Hawaii DOH\2. Laboratory Data\Alpha\WAF Study\L2317027\TPH\NF TPH\NF T  
... PH Quant.M  
Quant Title : FID Forensics  
QLast Update : Fri Sep 23 15:53:13 2022  
Response via : Initial Calibration  
Integrator: ChemStation

Volume Inj. : 1.0  
Signal Phase : Rtx-5MS  
Signal Info : 0.25mm

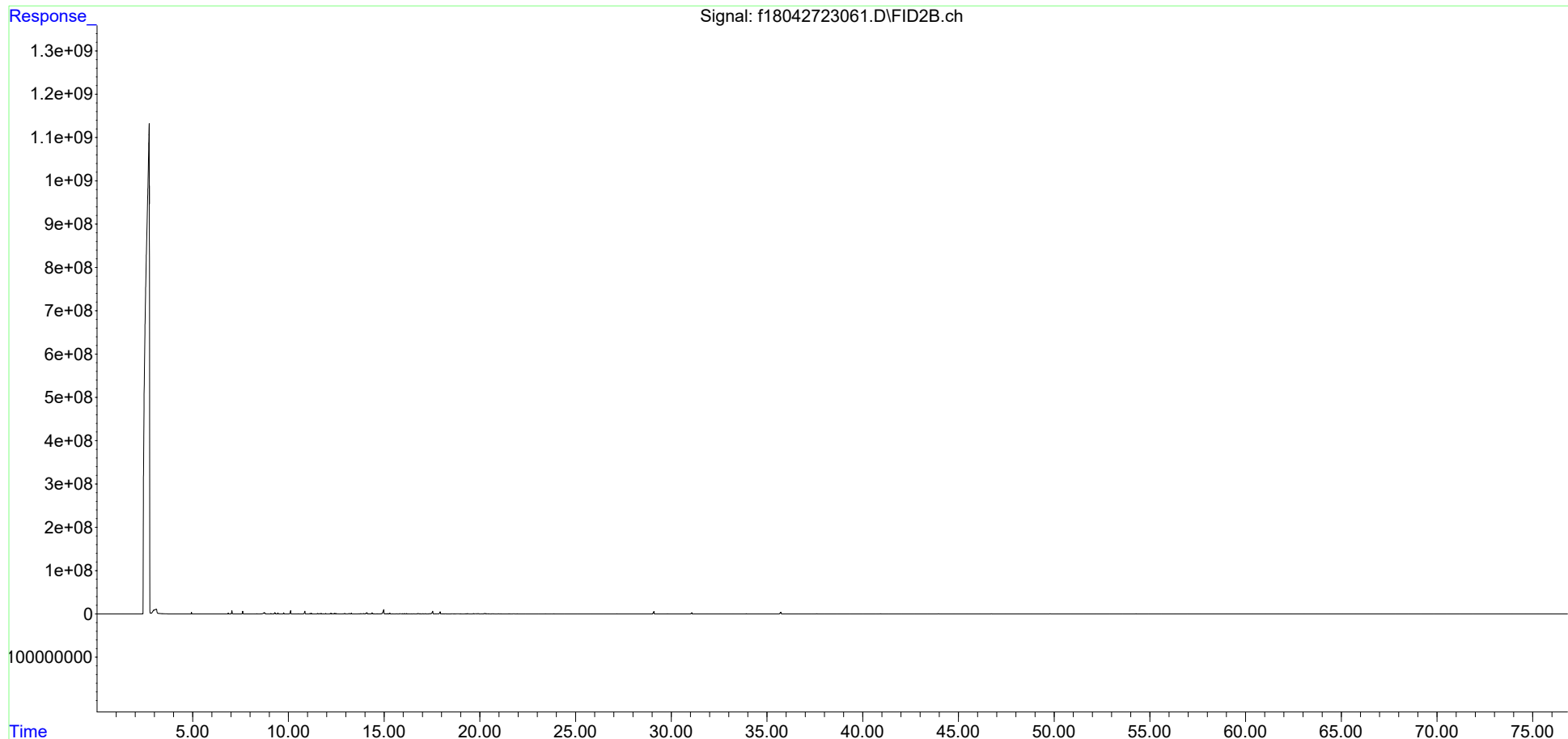

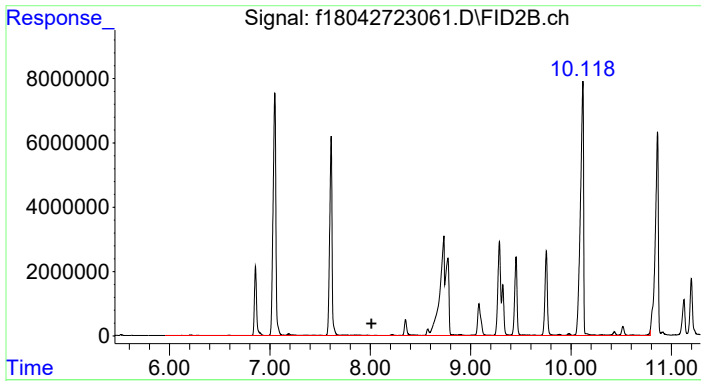

#4 > C8 to C10 Aliphatics

R.T.: 8.012 min  
 Delta R.T.: 0.000 min  
 Response: 822815139  
 Conc: 578.68 ug/mL m

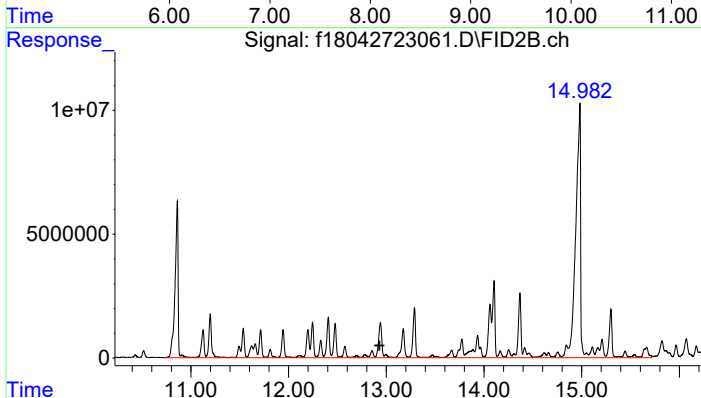

#5 > C10 to C12 Aliphatics

R.T.: 12.930 min  
 Delta R.T.: 0.000 min  
 Response: 1223296441  
 Conc: 860.34 ug/ml m

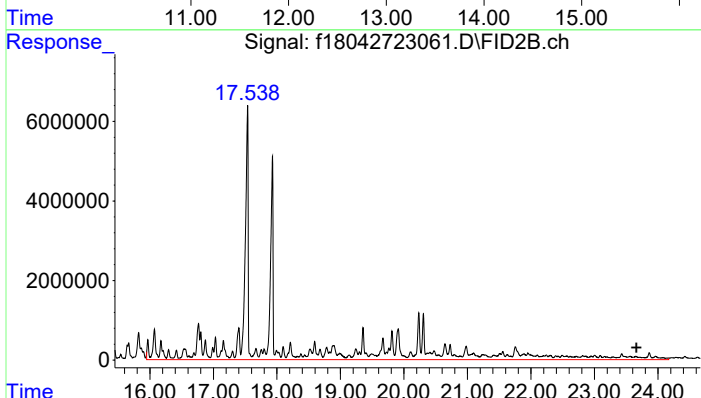

#6 > C12 to C16 Aliphatics

R.T.: 23.659 min  
 Delta R.T.: 0.000 min  
 Response: 1045437012  
 Conc: 735.25 UG/ML m

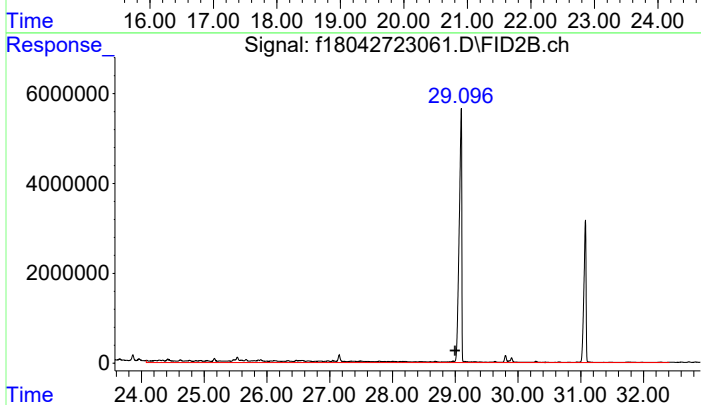

#7 > C16 to C21 Aliphatics

R.T.: 28.995 min  
 Delta R.T.: 0.000 min  
 Response: 117512309  
 Conc: 82.65 UG/ML m

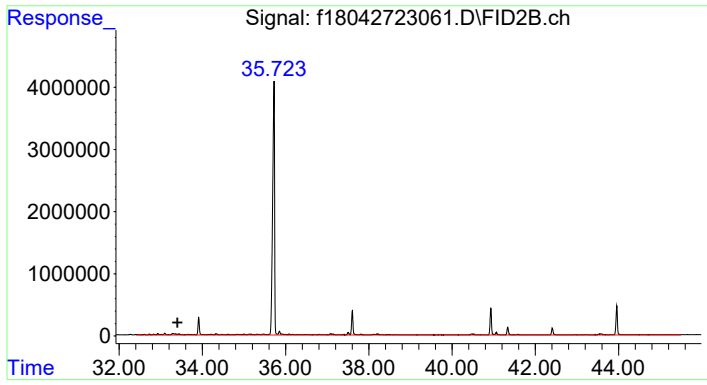

#8 > C21 to C32 Aliphatics

R.T.: 33.402 min  
Delta R.T.: 0.000 min  
Response: 94251643  
Conc: 66.29 UG/ML m

Data Path : C:\Projects\Hawaii DOH\2. Laboratory Data\Alpha\WAF Study\L2317027\TPH\NF TPH\  
 Data File : f18050523083.D  
 Signal(s) : FID2B.ch  
 Acq On : 07 May 2023 08:26 pm  
 Operator : FID18:AMV  
 Sample : L2317027-17F1  
 Misc : WG1775373,WG1771480,ICAL19877  
 ALS Vial : 92 Sample Multiplier: 1

Integration File: SHCINT2.E  
 Quant Time: May 31 16:14:16 2023  
 Quant Method : C:\Projects\Hawaii DOH\2. Laboratory Data\Alpha\WAF Study\L2317027\TPH\NF TPH\NF T  
 .. PH Quant.M  
 Quant Title : FID Forensics  
 QLast Update : Fri Sep 23 15:53:13 2022  
 Response via : Initial Calibration  
 Integrator: ChemStation

Volume Inj. : 1.0  
 Signal Phase : Rtx-5MS  
 Signal Info : 0.25mm

Blank Name : IB1805052303R  
 Blank File : f18050523061.D

Compound	R.T.	Response	Conc Units
-----			
Internal Standards			
1) I 5-alpha-androstane	30.946	71531943	50.000 ug/mL m
System Monitoring Compounds			
3) s d50-Tetracosane	35.604	118295388	100.047 ug/mL m
Spiked Amount 50.000	Range 50 - 130	Recovery	= 200.09%#
Target Compounds			
4) h > C8 to C10 Aliphatics	8.012	7854311	5.828 ug/mL m
5) h > C10 to C12 Aliphatics	12.930	5296549	3.930 ug/ml m
6) h > C12 to C16 Aliphatics	23.659	2693496	1.999 UG/ML m
7) h > C16 to C21 Aliphatics	28.995	2476686	1.838 UG/ML m
8) h > C21 to C32 Aliphatics	33.402	20287001	15.053 UG/ML m

SemiQuant Compounds - Not Calibrated on this Instrument

(f)=RT Delta > 1/2 Window

(m)=manual int.

Data Path : C:\Projects\Hawaii DOH\2. Laboratory Data\Alpha\WAF Study\L2317027\TPH\NF TPH\  
Data File : f18050523083.D  
Signal(s) : FID2B.ch  
Acq On : 07 May 2023 08:26 pm  
Operator : FID18:AMV  
Sample : L2317027-17F1  
Misc : WG1775373,WG1771480,ICAL19877  
ALS Vial : 92 Sample Multiplier: 1

Integration File: SHCINT2.E  
Quant Time: May 31 16:14:16 2023  
Quant Method : C:\Projects\Hawaii DOH\2. Laboratory Data\Alpha\WAF Study\L2317027\TPH\NF TPH\NF T  
... PH Quant.M  
Quant Title : FID Forensics  
QLast Update : Fri Sep 23 15:53:13 2022  
Response via : Initial Calibration  
Integrator: ChemStation

Volume Inj. : 1.0  
Signal Phase : Rtx-5MS  
Signal Info : 0.25mm

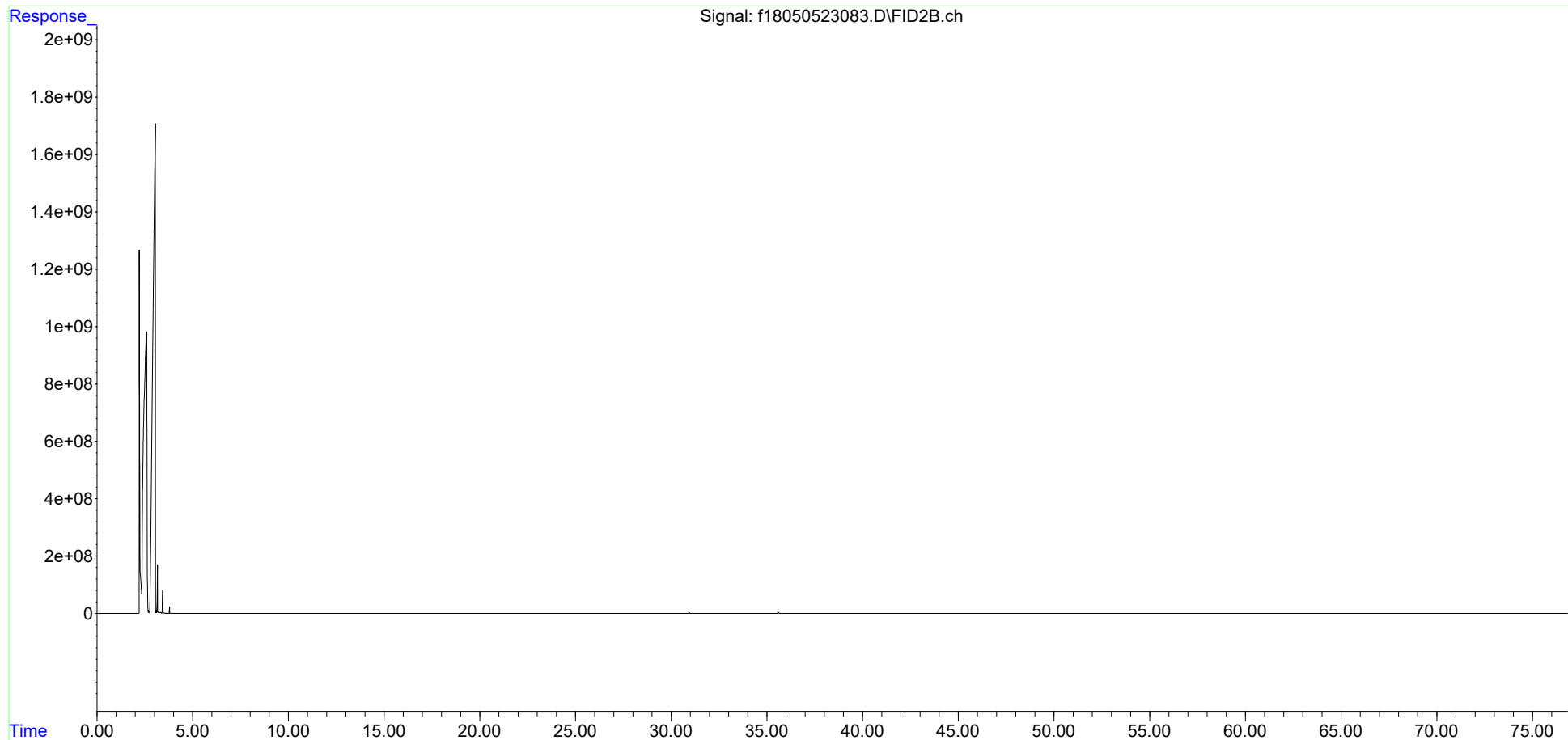

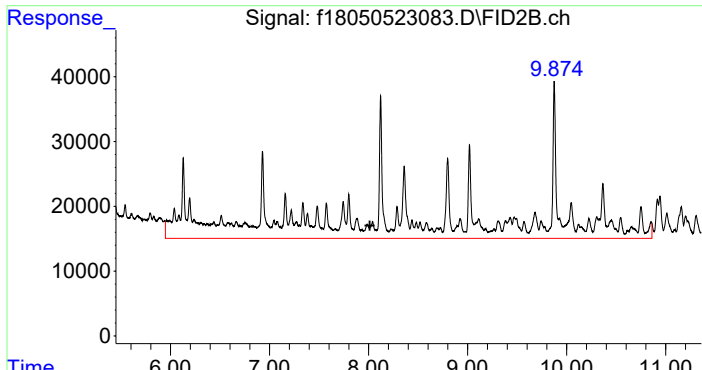

#4 > C8 to C10 Aliphatics  
 R.T.: 8.012 min  
 Delta R.T.: 0.000 min  
 Response: 7854311  
 Conc: 5.83 ug/mL m

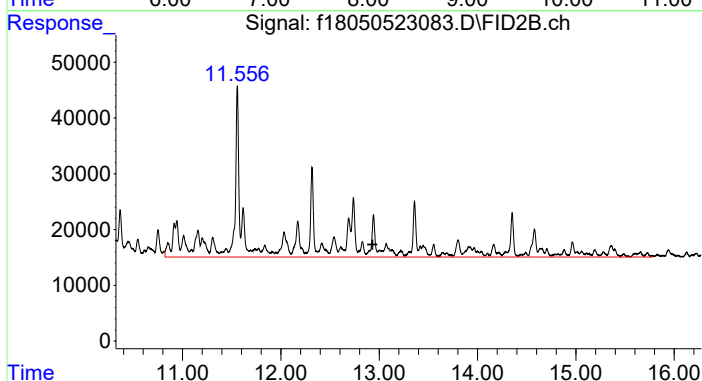

#5 > C10 to C12 Aliphatics  
 R.T.: 12.930 min  
 Delta R.T.: 0.000 min  
 Response: 5296549  
 Conc: 3.93 ug/ml m

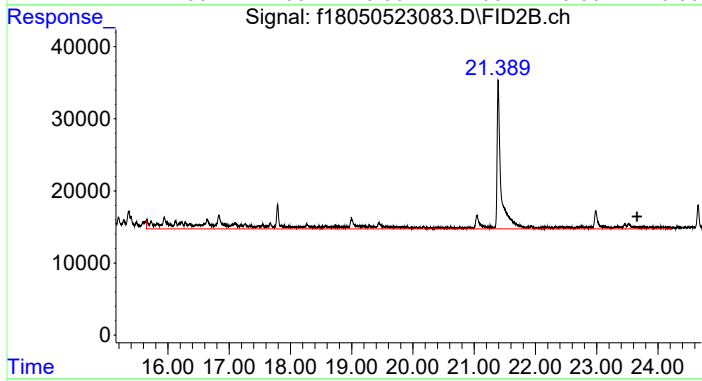

#6 > C12 to C16 Aliphatics  
 R.T.: 23.659 min  
 Delta R.T.: 0.000 min  
 Response: 2693496  
 Conc: 2.00 UG/ML m

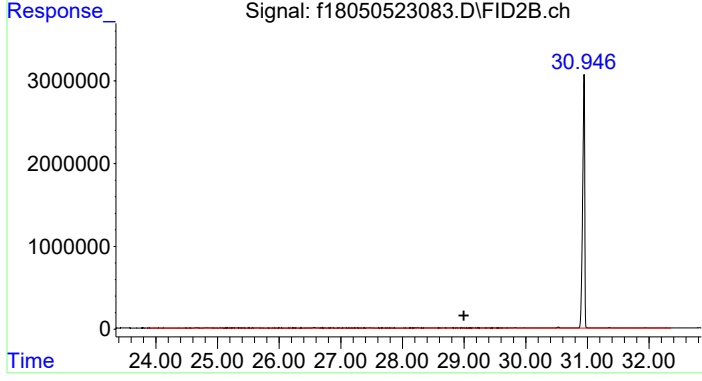

#7 > C16 to C21 Aliphatics  
 R.T.: 28.995 min  
 Delta R.T.: 0.000 min  
 Response: 2476686  
 Conc: 1.84 UG/ML m

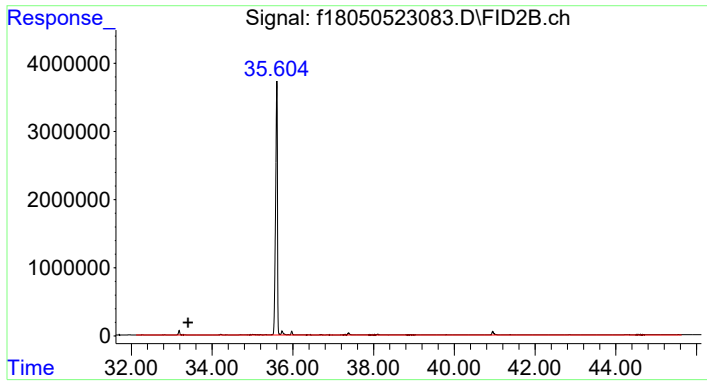

#8 > C21 to C32 Aliphatics

R.T.: 33.402 min  
Delta R.T.: 0.000 min  
Response: 20287001  
Conc: 15.05 UG/ML m



Data Path : C:\Projects\Hawaii DOH\2. Laboratory Data\Alpha\WAF Study\L2317027\TPH\NF TPH\  
 Data File : f18050823029.D  
 Signal(s) : FID2B.ch  
 Acq On : 09 May 2023 04:50 am  
 Operator : FID18:AMV  
 Sample : L2317027-18F2  
 Misc : WG1776333,WG1771481,ICAL19877  
 ALS Vial : 65 Sample Multiplier: 1

Integration File: SHCINT2.E  
 Quant Time: Jun 01 10:44:30 2023  
 Quant Method : C:\Projects\Hawaii DOH\2. Laboratory Data\Alpha\WAF Study\L2317027\TPH\NF TPH\NF T  
 .. PH Quant.M  
 Quant Title : FID Forensics  
 QLast Update : Fri Sep 23 15:53:13 2022  
 Response via : Initial Calibration  
 Integrator: ChemStation

Volume Inj. : 1.0  
 Signal Phase : Rtx-5MS  
 Signal Info : 0.25mm

Blank Name : IB1805082301R  
 Blank File : f18050823009.D

Compound	R.T.	Response	Conc Units
-----			
Internal Standards			
1) I 5-alpha-androstane	30.936	63529684	50.000 ug/mL m
System Monitoring Compounds			
2) s ortho-terphenyl	28.954	113371944	85.363 ug/mL m
Spiked Amount 50.000	Range 50 - 130	Recovery	= 170.73%#
Target Compounds			
9) h > C8 to C10 Aromatics	7.704	347571159	290.389 UG/ML m
10) h > C10 to C12 Aromatics	12.274	659997269	551.415 UG/ML m
11) h > C12 to C16 Aromatics	17.385	436054799	364.315 UG/ML m
12) h > C16 to C21 Aromatics	28.995	11411098	9.534 UG/ML m
13) h > C21 to C32 Aromatics	34.889	21298104	17.794 UG/ML m

SemiQuant Compounds - Not Calibrated on this Instrument

(f)=RT Delta > 1/2 Window

(m)=manual int.

Data Path : C:\Projects\Hawaii DOH\2. Laboratory Data\Alpha\WAF Study\L2317027\TPH\NF TPH\  
Data File : f18050823029.D  
Signal(s) : FID2B.ch  
Acq On : 09 May 2023 04:50 am  
Operator : FID18:AMV  
Sample : L2317027-18F2  
Misc : WG1776333,WG1771481,ICAL19877  
ALS Vial : 65 Sample Multiplier: 1

Integration File: SHCINT2.E  
Quant Time: Jun 01 10:44:30 2023  
Quant Method : C:\Projects\Hawaii DOH\2. Laboratory Data\Alpha\WAF Study\L2317027\TPH\NF TPH\NF T  
... PH Quant.M  
Quant Title : FID Forensics  
QLast Update : Fri Sep 23 15:53:13 2022  
Response via : Initial Calibration  
Integrator: ChemStation

Volume Inj. : 1.0  
Signal Phase : Rtx-5MS  
Signal Info : 0.25mm

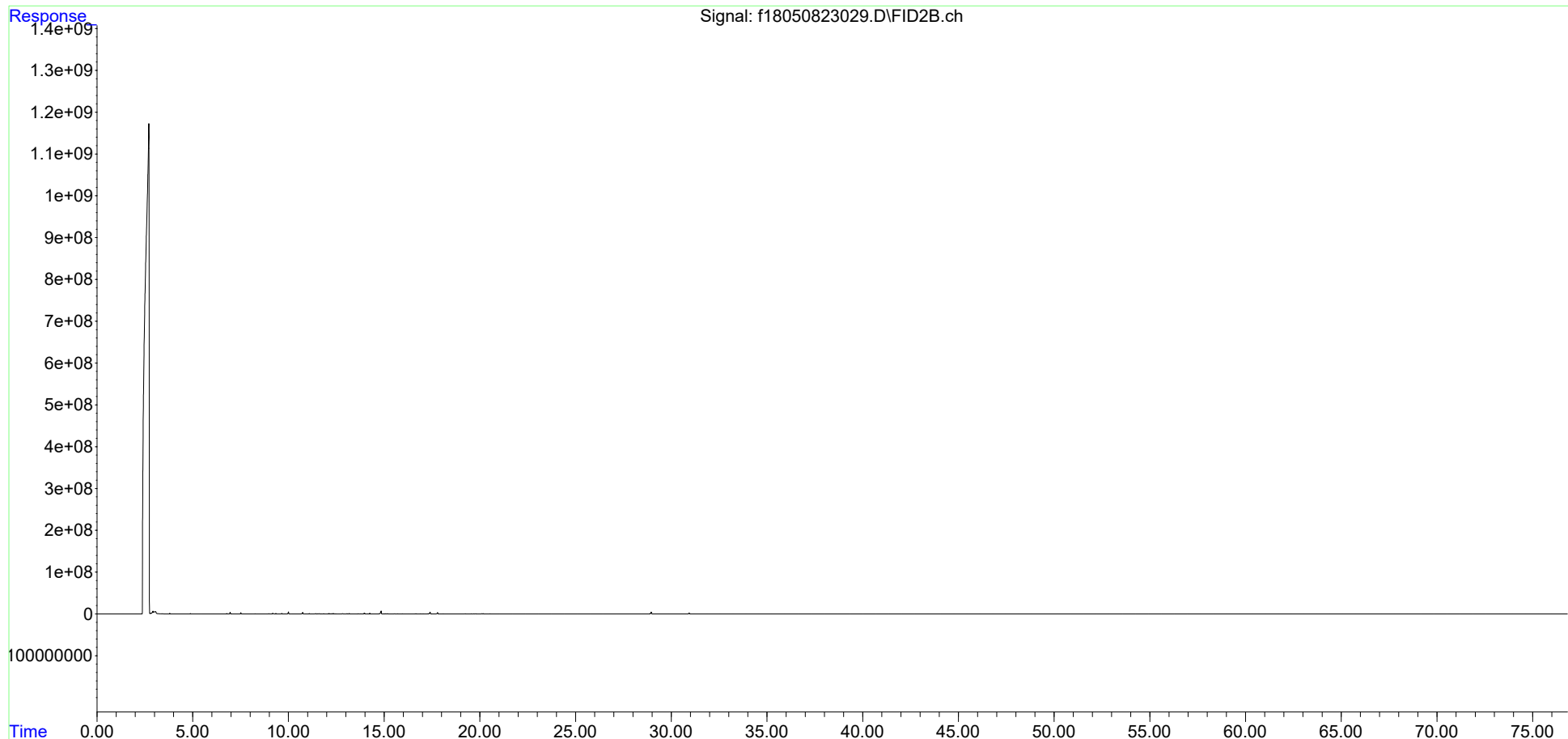

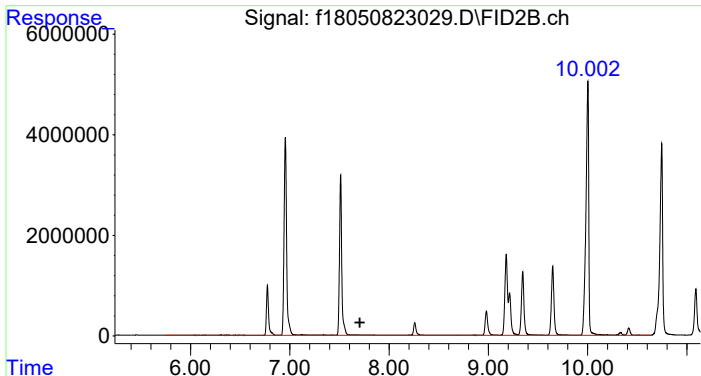

#9 > C8 to C10 Aromatics  
 R.T.: 7.704 min  
 Delta R.T.: 0.000 min  
 Response: 347571159  
 Conc: 290.39 UG/ML m

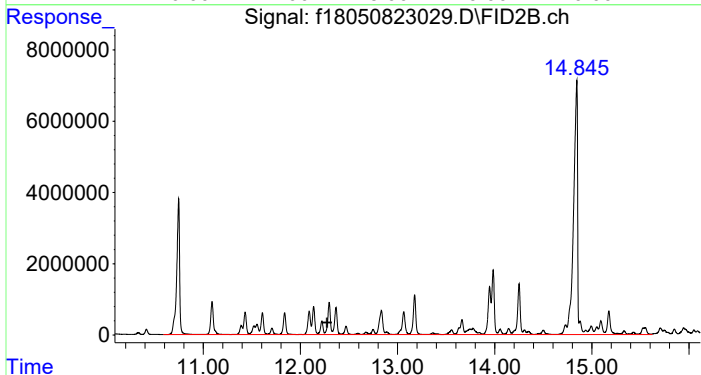

#10 > C10 to C12 Aromatics  
 R.T.: 12.274 min  
 Delta R.T.: 0.000 min  
 Response: 659997269  
 Conc: 551.41 UG/ML m

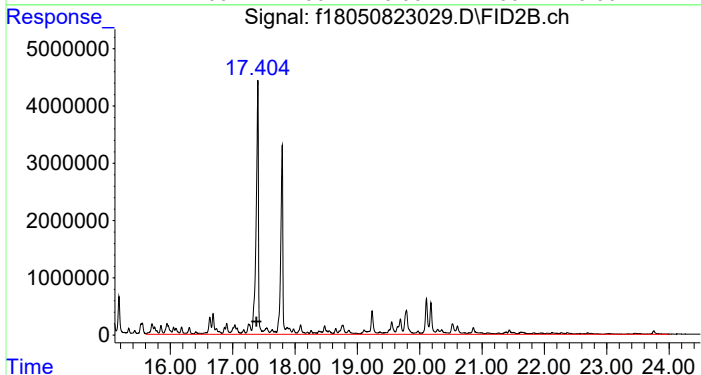

#11 > C12 to C16 Aromatics  
 R.T.: 17.385 min  
 Delta R.T.: 0.000 min  
 Response: 436054799  
 Conc: 364.32 UG/ML m

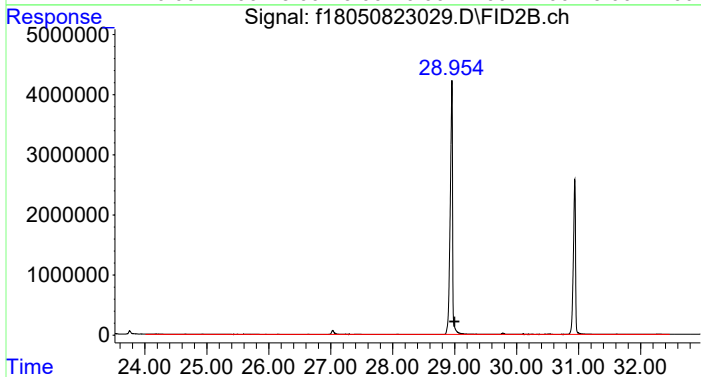

#12 > C16 to C21 Aromatics  
 R.T.: 28.995 min  
 Delta R.T.: 0.000 min  
 Response: 11411098  
 Conc: 9.53 UG/ML m

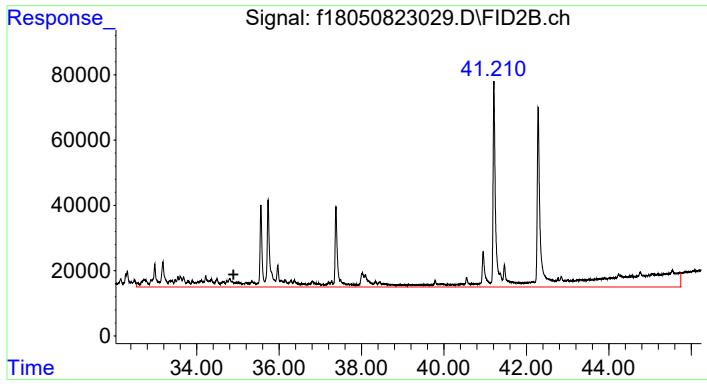

#13 > C21 to C32 Aromatics

R.T.: 34.889 min  
Delta R.T.: 0.000 min  
Response: 21298104  
Conc: 17.79 UG/ML m

Data Path : C:\Projects\Hawaii DOH\2. Laboratory Data\Alpha\WAF Study\L2317027\TPH\NF TPH\  
 Data File : f18042723041.D  
 Signal(s) : FID2B.ch  
 Acq On : 28 Apr 2023 01:47 pm  
 Operator : FID18:AMV  
 Sample : L2317027-19  
 Misc : WG1772069,WG1769453,ICAL19877  
 ALS Vial : 71 Sample Multiplier: 1

Integration File: SHCINT2.E  
 Quant Time: Jun 01 11:08:25 2023  
 Quant Method : C:\Projects\Hawaii DOH\2. Laboratory Data\Alpha\WAF Study\L2317027\TPH\NF TPH\NF T  
 .. PH Quant.M  
 Quant Title : FID Forensics  
 QLast Update : Wed May 31 16:55:59 2023  
 Response via : Initial Calibration  
 Integrator: ChemStation

Volume Inj. : 1.0  
 Signal Phase : Rtx-5MS  
 Signal Info : 0.25mm

Blank Name : IB1804272302R  
 Blank File : f18042723039.D

Compound	R.T.	Response	Conc Units
-----			
Internal Standards			
1) I 5-alpha-androstane	31.069	62994076	50.000 ug/mL m
System Monitoring Compounds			
2) s ortho-terphenyl	29.092	148399268	112.686 ug/mL m
Spiked Amount 50.000	Range 50 - 130	Recovery = 225.37%#	
3) s d50-Tetracosane	35.719	121390728	116.580 ug/mL m
Spiked Amount 50.000	Range 50 - 130	Recovery = 233.16%#	
Target Compounds			
4) h > C8 to C10 Aliphatics	8.012	605716426	510.367 ug/mL m
5) h > C10 to C12 Aliphatics	12.930	1078827868	909.003 ug/ml m
6) h > C12 to C16 Aliphatics	23.659	978090498	824.123 UG/ML m
7) h > C16 to C21 Aliphatics	28.995	94093217	79.281 UG/ML m
8) h > C21 to C32 Aliphatics	33.402	27172178	22.895 UG/ML m

SemiQuant Compounds - Not Calibrated on this Instrument

(f)=RT Delta > 1/2 Window

(m)=manual int.

Data Path : C:\Projects\Hawaii DOH\2. Laboratory Data\Alpha\WAF Study\L2317027\TPH\NF TPH\  
Data File : f18042723041.D  
Signal(s) : FID2B.ch  
Acq On : 28 Apr 2023 01:47 pm  
Operator : FID18:AMV  
Sample : L2317027-19  
Misc : WG1772069,WG1769453,ICAL19877  
ALS Vial : 71 Sample Multiplier: 1

Integration File: SHCINT2.E  
Quant Time: Jun 01 11:08:25 2023  
Quant Method : C:\Projects\Hawaii DOH\2. Laboratory Data\Alpha\WAF Study\L2317027\TPH\NF TPH\NF T  
... PH Quant.M  
Quant Title : FID Forensics  
QLast Update : Wed May 31 16:55:59 2023  
Response via : Initial Calibration  
Integrator: ChemStation

Volume Inj. : 1.0  
Signal Phase : Rtx-5MS  
Signal Info : 0.25mm

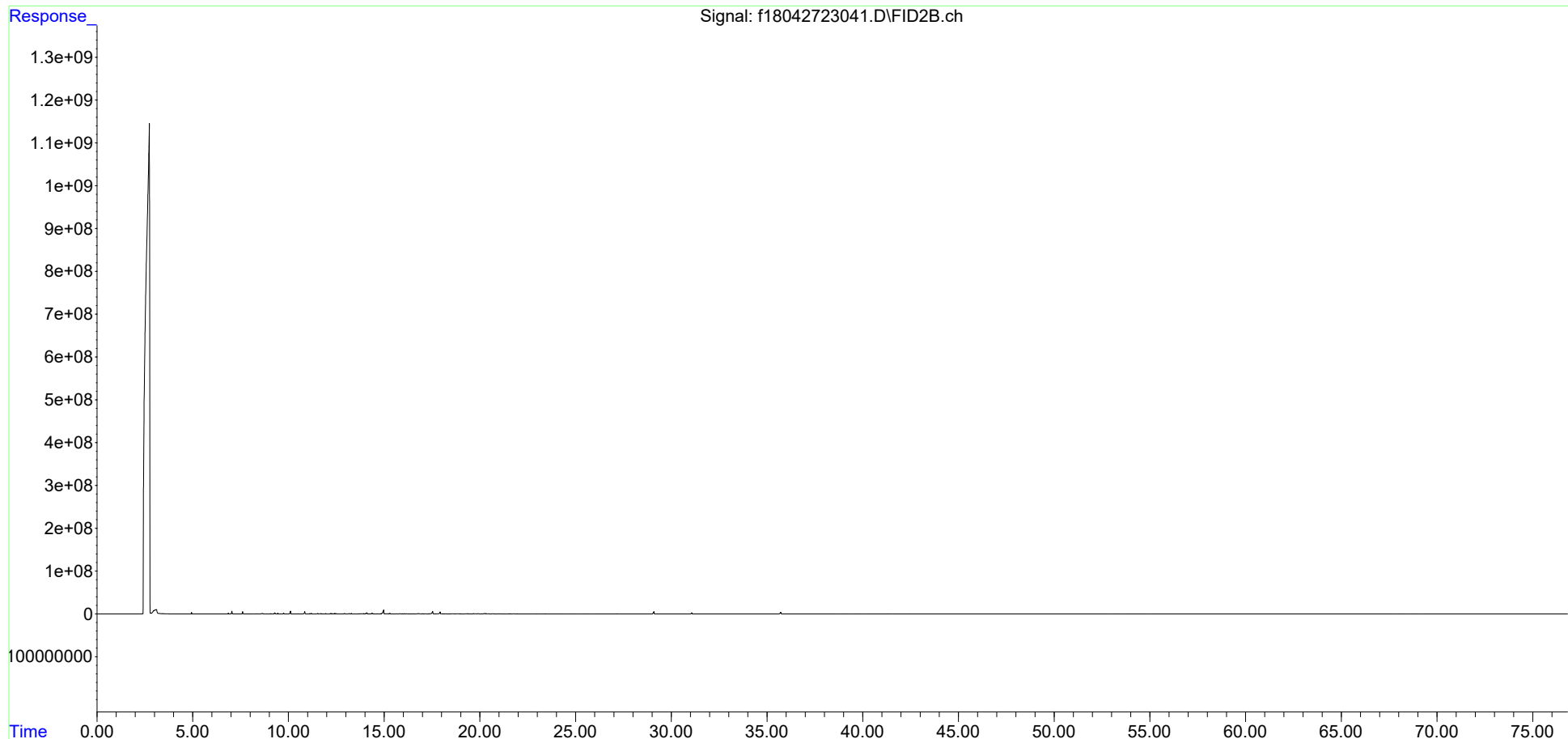

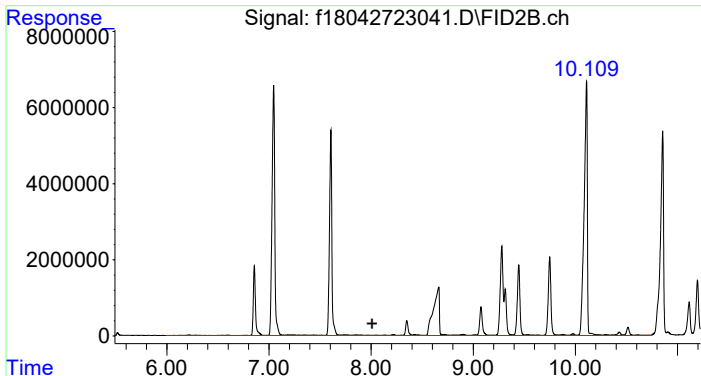

#4 > C8 to C10 Aliphatics

R.T.: 8.012 min  
 Delta R.T.: 0.000 min  
 Response: 605716426  
 Conc: 510.37 ug/mL m

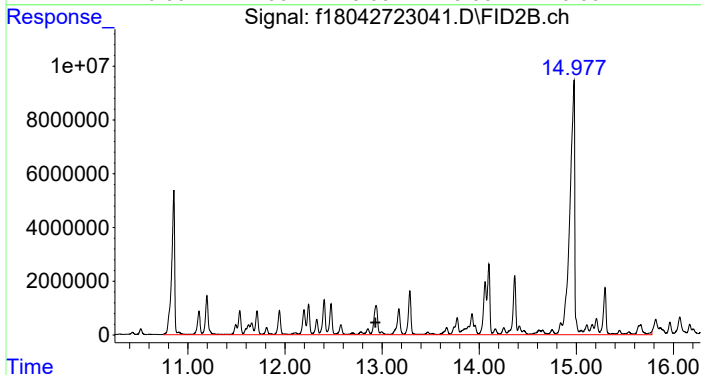

#5 > C10 to C12 Aliphatics

R.T.: 12.930 min  
 Delta R.T.: 0.000 min  
 Response: 1078827868  
 Conc: 909.00 ug/ml m

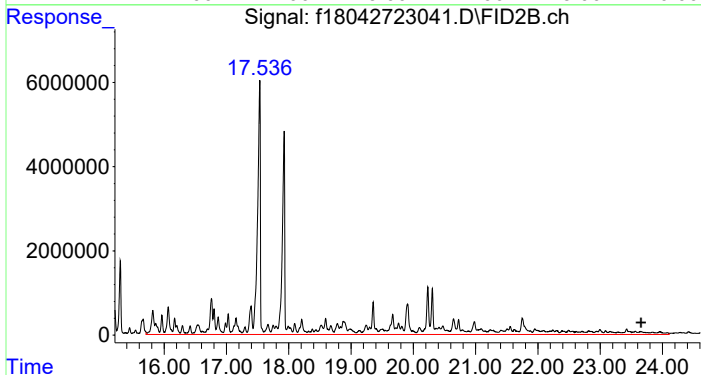

#6 > C12 to C16 Aliphatics

R.T.: 23.659 min  
 Delta R.T.: 0.000 min  
 Response: 978090498  
 Conc: 824.12 UG/ML m

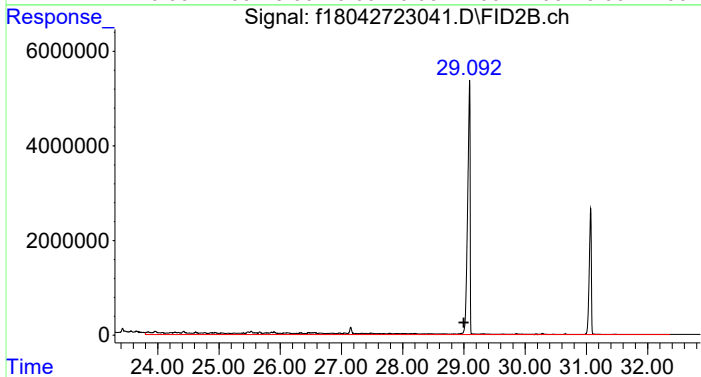

#7 > C16 to C21 Aliphatics

R.T.: 28.995 min  
 Delta R.T.: 0.000 min  
 Response: 94093217  
 Conc: 79.28 UG/ML m

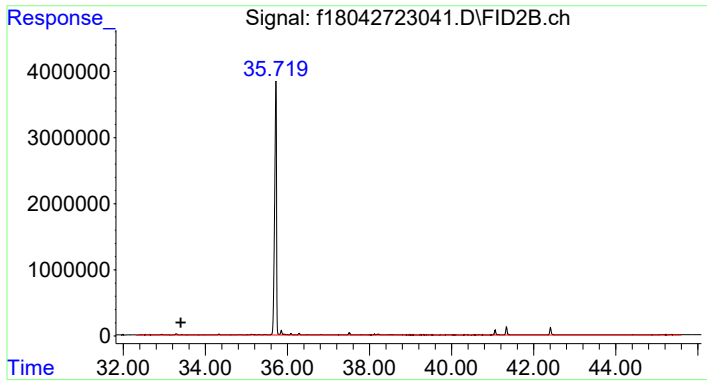

#8 > C21 to C32 Aliphatics

R.T.: 33.402 min  
Delta R.T.: 0.000 min  
Response: 27172178  
Conc: 22.89 UG/ML m



Data Path : C:\Projects\Hawaii DOH\2. Laboratory Data\Alpha\WAF Study\L2317027\TPH\NF TPH\  
 Data File : f18050523085.D  
 Signal(s) : FID2B.ch  
 Acq On : 07 May 2023 09:50 pm  
 Operator : FID18:AMV  
 Sample : L2317027-20F1  
 Misc : WG1775373,WG1771482,ICAL19877  
 ALS Vial : 93 Sample Multiplier: 1

Integration File: SHCINT2.E  
 Quant Time: May 31 16:16:50 2023  
 Quant Method : C:\Projects\Hawaii DOH\2. Laboratory Data\Alpha\WAF Study\L2317027\TPH\NF TPH\NF T  
 .. PH Quant.M  
 Quant Title : FID Forensics  
 QLast Update : Fri Sep 23 15:53:13 2022  
 Response via : Initial Calibration  
 Integrator: ChemStation

Volume Inj. : 1.0  
 Signal Phase : Rtx-5MS  
 Signal Info : 0.25mm

Blank Name : IB1805052303R  
 Blank File : f18050523061.D

Compound	R.T.	Response	Conc Units
-----			
Internal Standards			
1) I 5-alpha-androstane	30.944	69420315	50.000 ug/mL m
System Monitoring Compounds			
3) s d50-Tetracosane	35.607	127546679	111.152 ug/mL m
Spiked Amount 50.000	Range 50 - 130	Recovery	= 222.30%#
Target Compounds			
4) h > C8 to C10 Aliphatics	8.012	20429696	15.620 ug/mL m
5) h > C10 to C12 Aliphatics	12.930	7522338	5.751 ug/ml m
6) h > C12 to C16 Aliphatics	23.659	2635194	2.015 UG/ML m
7) h > C16 to C21 Aliphatics	28.995	2766915	2.116 UG/ML m
8) h > C21 to C32 Aliphatics	33.402	18643177	14.254 UG/ML m

SemiQuant Compounds - Not Calibrated on this Instrument

(f)=RT Delta > 1/2 Window

(m)=manual int.

Data Path : C:\Projects\Hawaii DOH\2. Laboratory Data\Alpha\WAF Study\L2317027\TPH\NF TPH\  
Data File : f18050523085.D  
Signal(s) : FID2B.ch  
Acq On : 07 May 2023 09:50 pm  
Operator : FID18:AMV  
Sample : L2317027-20F1  
Misc : WG1775373,WG1771482,ICAL19877  
ALS Vial : 93 Sample Multiplier: 1

Integration File: SHCINT2.E  
Quant Time: May 31 16:16:50 2023  
Quant Method : C:\Projects\Hawaii DOH\2. Laboratory Data\Alpha\WAF Study\L2317027\TPH\NF TPH\NF T  
... PH Quant.M  
Quant Title : FID Forensics  
QLast Update : Fri Sep 23 15:53:13 2022  
Response via : Initial Calibration  
Integrator: ChemStation

Volume Inj. : 1.0  
Signal Phase : Rtx-5MS  
Signal Info : 0.25mm

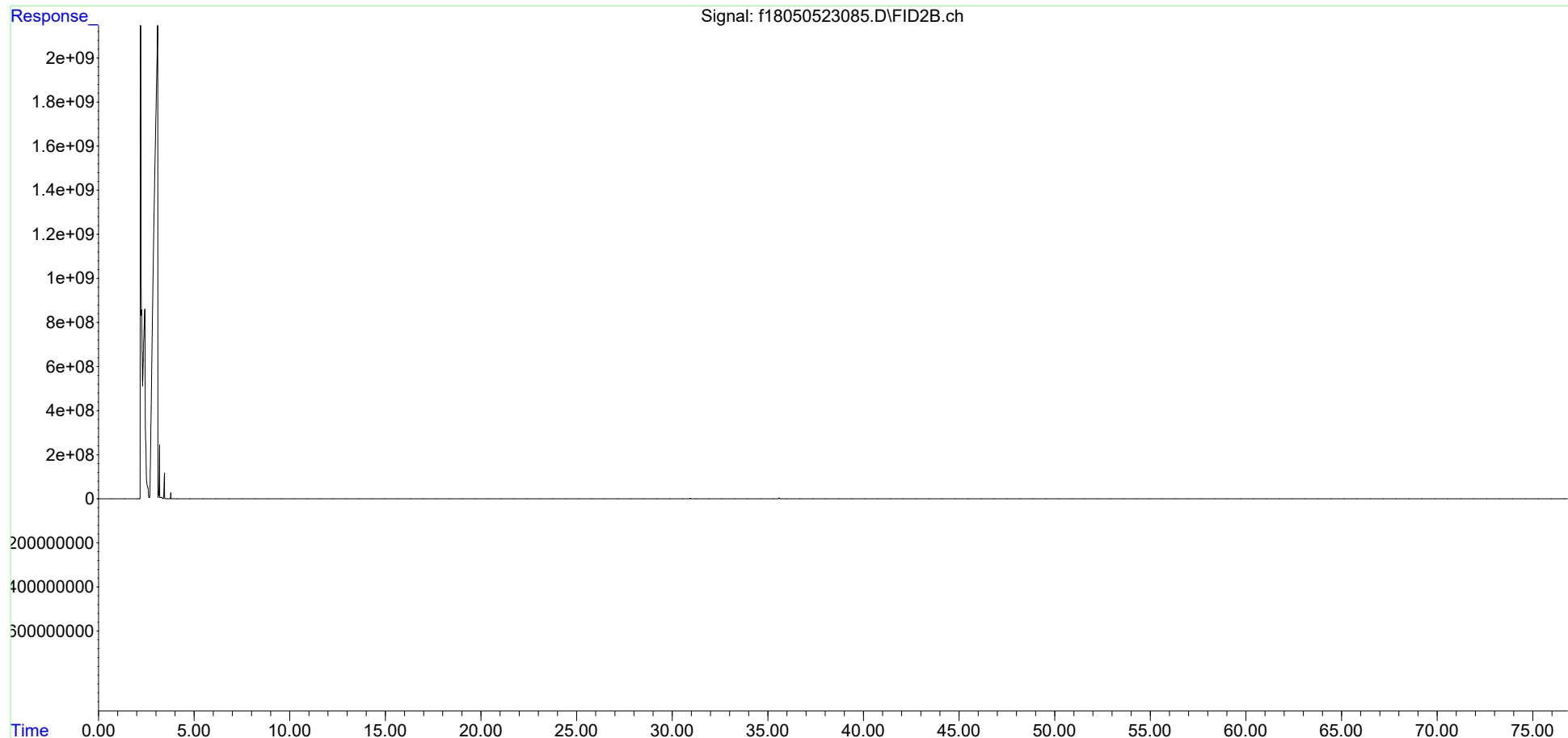

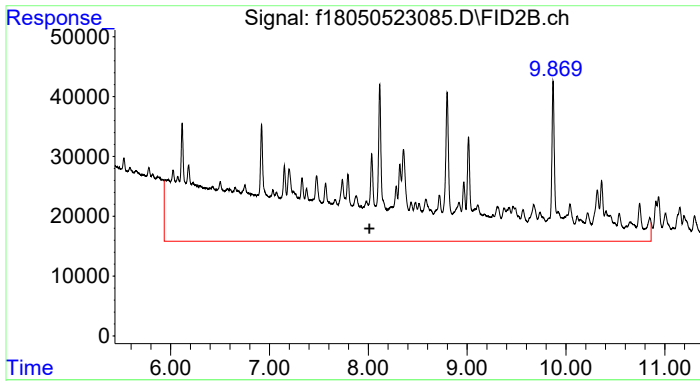

#4 > C8 to C10 Aliphatics

R.T.: 8.012 min  
 Delta R.T.: 0.000 min  
 Response: 20429696  
 Conc: 15.62 ug/mL m

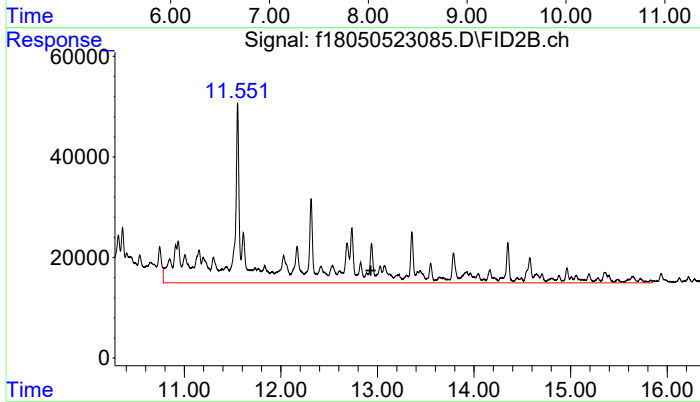

#5 > C10 to C12 Aliphatics

R.T.: 12.930 min  
 Delta R.T.: 0.000 min  
 Response: 7522338  
 Conc: 5.75 ug/ml m

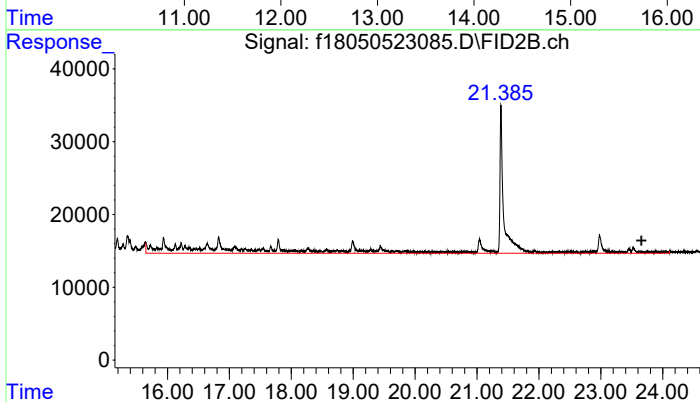

#6 > C12 to C16 Aliphatics

R.T.: 23.659 min  
 Delta R.T.: 0.000 min  
 Response: 2635194  
 Conc: 2.01 UG/ML m

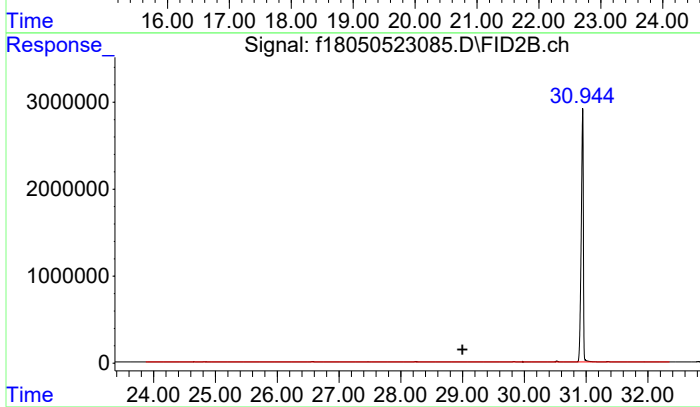

#7 > C16 to C21 Aliphatics

R.T.: 28.995 min  
 Delta R.T.: 0.000 min  
 Response: 2766915  
 Conc: 2.12 UG/ML m

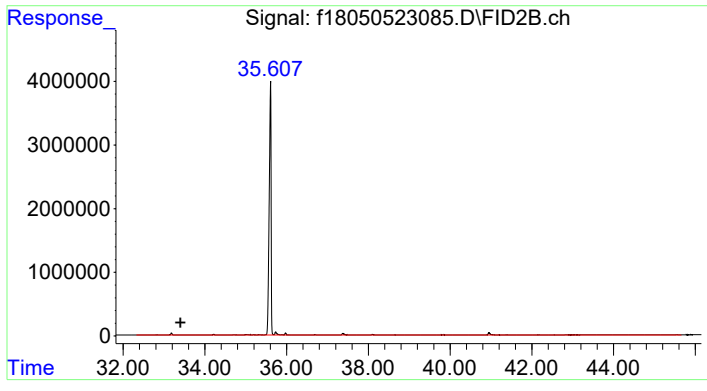

#8 > C21 to C32 Aliphatics

R.T.: 33.402 min  
Delta R.T.: 0.000 min  
Response: 18643177  
Conc: 14.25 UG/ML m

Data Path : C:\Projects\Hawaii DOH\2. Laboratory Data\Alpha\WAF Study\L2317027\TPH\NF TPH\  
 Data File : f18050823031.D  
 Signal(s) : FID2B.ch  
 Acq On : 09 May 2023 06:13 am  
 Operator : FID18:AMV  
 Sample : L2317027-21F2  
 Misc : WG1776333,WG1771483,ICAL19877  
 ALS Vial : 66 Sample Multiplier: 1

Integration File: SHCINT2.E  
 Quant Time: Jun 01 10:47:15 2023  
 Quant Method : C:\Projects\Hawaii DOH\2. Laboratory Data\Alpha\WAF Study\L2317027\TPH\NF TPH\NF T  
 .. PH Quant.M  
 Quant Title : FID Forensics  
 QLast Update : Fri Sep 23 15:53:13 2022  
 Response via : Initial Calibration  
 Integrator: ChemStation

Volume Inj. : 1.0  
 Signal Phase : Rtx-5MS  
 Signal Info : 0.25mm

Blank Name : IB1805082301R  
 Blank File : f18050823009.D

Compound	R.T.	Response	Conc Units
-----			
Internal Standards			
1) I 5-alpha-androstane	30.939	70101462	50.000 ug/mL m
System Monitoring Compounds			
2) s ortho-terphenyl	28.963	139256324	95.023 ug/mL m
Spiked Amount 50.000	Range 50 - 130	Recovery =	190.05%#
Target Compounds			
9) h > C8 to C10 Aromatics	7.704	367912437	278.567 UG/ML m
10) h > C10 to C12 Aromatics	12.274	764751881	579.037 UG/ML m
11) h > C12 to C16 Aromatics	17.385	522365167	395.512 UG/ML m
12) h > C16 to C21 Aromatics	28.995	11129677	8.427 UG/ML m
13) h > C21 to C32 Aromatics	34.889	23156577	17.533 UG/ML m

SemiQuant Compounds - Not Calibrated on this Instrument

(f)=RT Delta > 1/2 Window

(m)=manual int.

Data Path : C:\Projects\Hawaii DOH\2. Laboratory Data\Alpha\WAF Study\L2317027\TPH\NF TPH\  
Data File : f18050823031.D  
Signal(s) : FID2B.ch  
Acq On : 09 May 2023 06:13 am  
Operator : FID18:AMV  
Sample : L2317027-21F2  
Misc : WG1776333,WG1771483,ICAL19877  
ALS Vial : 66 Sample Multiplier: 1

Integration File: SHCINT2.E  
Quant Time: Jun 01 10:47:15 2023  
Quant Method : C:\Projects\Hawaii DOH\2. Laboratory Data\Alpha\WAF Study\L2317027\TPH\NF TPH\NF T  
PH Quant.M  
Quant Title : FID Forensics  
QLast Update : Fri Sep 23 15:53:13 2022  
Response via : Initial Calibration  
Integrator: ChemStation

Volume Inj. : 1.0  
Signal Phase : Rtx-5MS  
Signal Info : 0.25mm

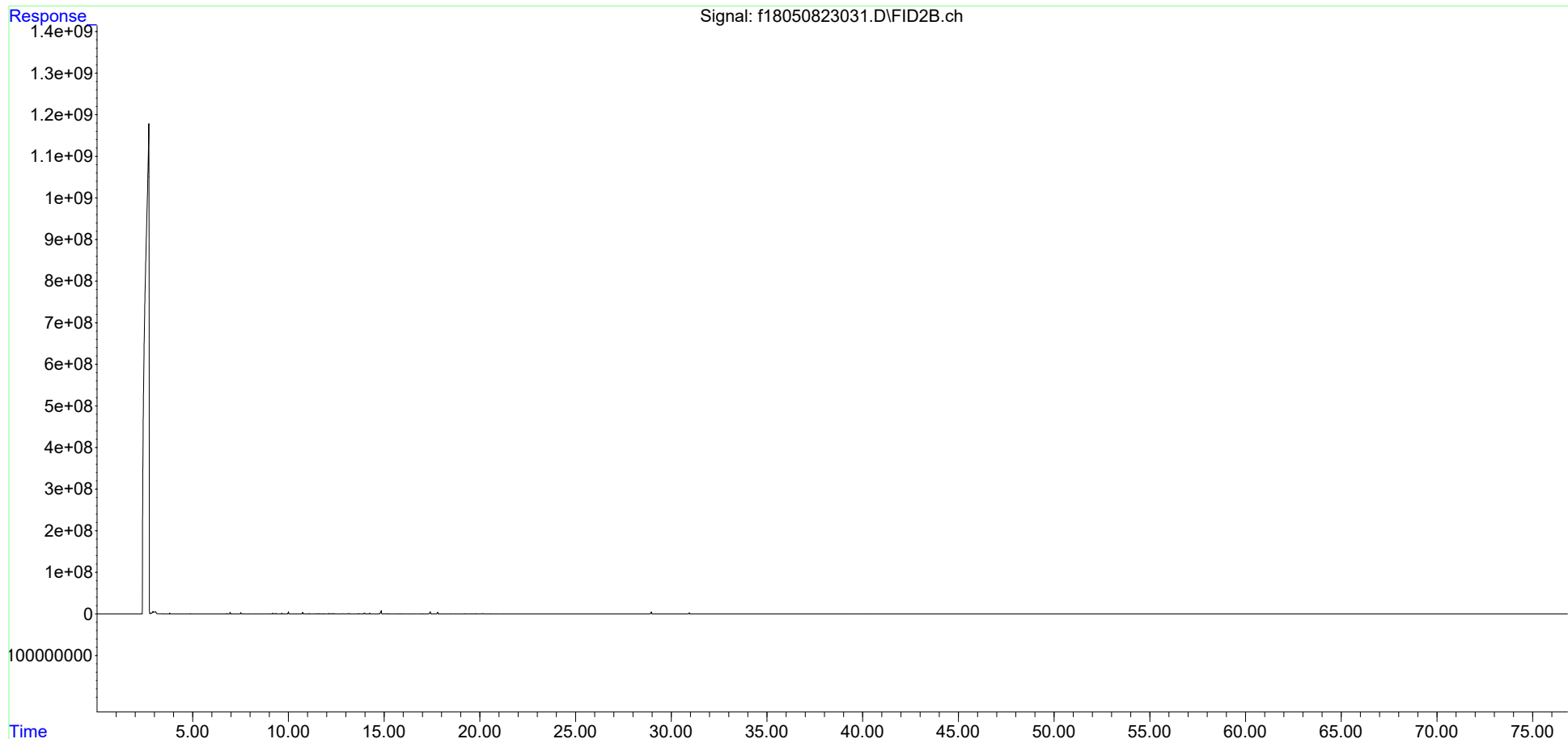

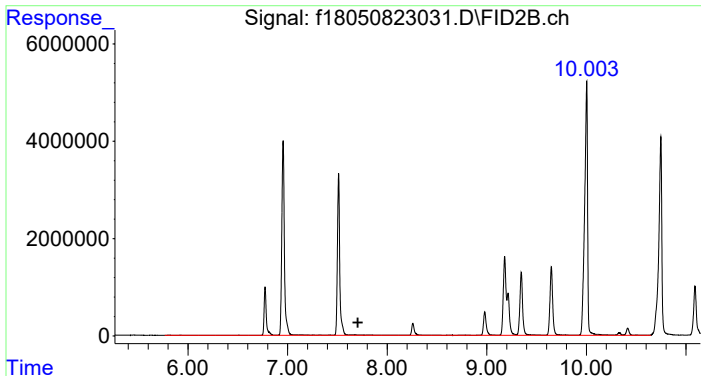

#9 > C8 to C10 Aromatics  
 R.T.: 7.704 min  
 Delta R.T.: 0.000 min  
 Response: 367912437  
 Conc: 278.57 UG/ML m

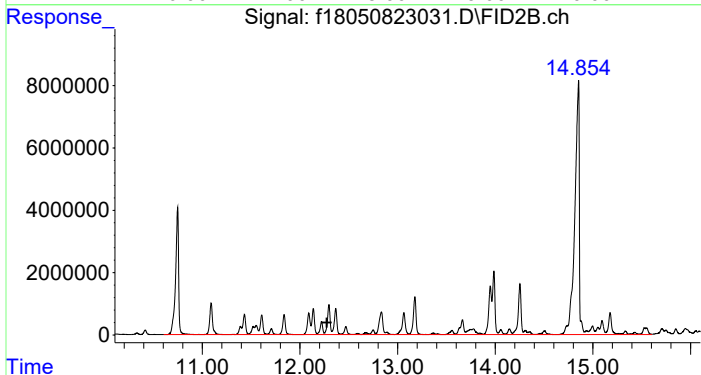

#10 > C10 to C12 Aromatics  
 R.T.: 12.274 min  
 Delta R.T.: 0.000 min  
 Response: 764751881  
 Conc: 579.04 UG/ML m

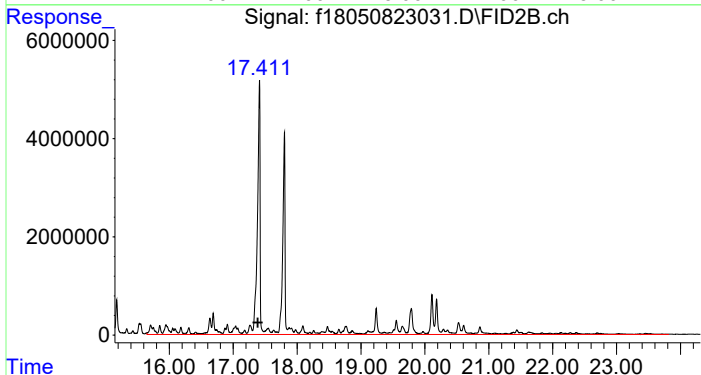

#11 > C12 to C16 Aromatics  
 R.T.: 17.385 min  
 Delta R.T.: 0.000 min  
 Response: 522365167  
 Conc: 395.51 UG/ML m

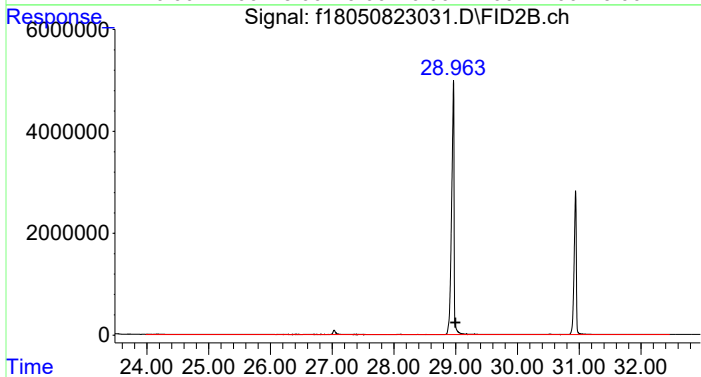

#12 > C16 to C21 Aromatics  
 R.T.: 28.995 min  
 Delta R.T.: 0.000 min  
 Response: 11129677  
 Conc: 8.43 UG/ML m

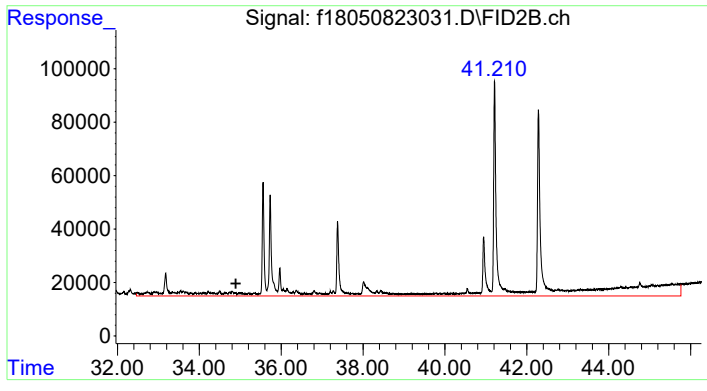

#13 > C21 to C32 Aromatics

R.T.: 34.889 min  
Delta R.T.: 0.000 min  
Response: 23156577  
Conc: 17.53 UG/ML m



Data Path : C:\Projects\Hawaii DOH\2. Laboratory Data\Alpha\WAF Study\L2317027\TPH\NF TPH\  
 Data File : f18042723043.D  
 Signal(s) : FID2B.ch  
 Acq On : 28 Apr 2023 03:11 pm  
 Operator : FID18:AMV  
 Sample : L2317027-22  
 Misc : WG1772069,WG1769453,ICAL19877  
 ALS Vial : 72 Sample Multiplier: 1

Integration File: SHCINT2.E  
 Quant Time: Jun 01 11:13:01 2023  
 Quant Method : C:\Projects\Hawaii DOH\2. Laboratory Data\Alpha\WAF Study\L2317027\TPH\NF TPH\NF T  
 .. PH Quant.M  
 Quant Title : FID Forensics  
 QLast Update : Fri Sep 23 15:53:13 2022  
 Response via : Initial Calibration  
 Integrator: ChemStation

Volume Inj. : 1.0  
 Signal Phase : Rtx-5MS  
 Signal Info : 0.25mm

Blank Name : IB1804272302R  
 Blank File : f18042723039.D

Compound	R.T.	Response	Conc Units
-----			
Internal Standards			
1) I 5-alpha-androstane	31.068	65695273	50.000 ug/mL m
System Monitoring Compounds			
2) s ortho-terphenyl	29.088	143011516	104.130 ug/mL m
Spiked Amount 50.000	Range 50 - 130	Recovery = 208.26%#	
3) s d50-Tetracosane	35.714	114028159	105.006 ug/mL m
Spiked Amount 50.000	Range 50 - 130	Recovery = 210.01%#	
Target Compounds			
4) h > C8 to C10 Aliphatics	8.012	677188641	547.127 ug/mL m
5) h > C10 to C12 Aliphatics	12.930	1064940106	860.407 ug/ml m
6) h > C12 to C16 Aliphatics	23.659	973851106	786.813 UG/ML m
7) h > C16 to C21 Aliphatics	28.995	96953118	78.332 UG/ML m
8) h > C21 to C32 Aliphatics	33.402	67547811	54.575 UG/ML m

SemiQuant Compounds - Not Calibrated on this Instrument

(f)=RT Delta > 1/2 Window

(m)=manual int.

Data Path : C:\Projects\Hawaii DOH\2. Laboratory Data\Alpha\WAF Study\L2317027\TPH\NF TPH\  
Data File : f18042723043.D  
Signal(s) : FID2B.ch  
Acq On : 28 Apr 2023 03:11 pm  
Operator : FID18:AMV  
Sample : L2317027-22  
Misc : WG1772069,WG1769453,ICAL19877  
ALS Vial : 72 Sample Multiplier: 1

Integration File: SHCINT2.E  
Quant Time: Jun 01 11:13:01 2023  
Quant Method : C:\Projects\Hawaii DOH\2. Laboratory Data\Alpha\WAF Study\L2317027\TPH\NF TPH\NF T  
... PH Quant.M  
Quant Title : FID Forensics  
QLast Update : Fri Sep 23 15:53:13 2022  
Response via : Initial Calibration  
Integrator: ChemStation

Volume Inj. : 1.0  
Signal Phase : Rtx-5MS  
Signal Info : 0.25mm

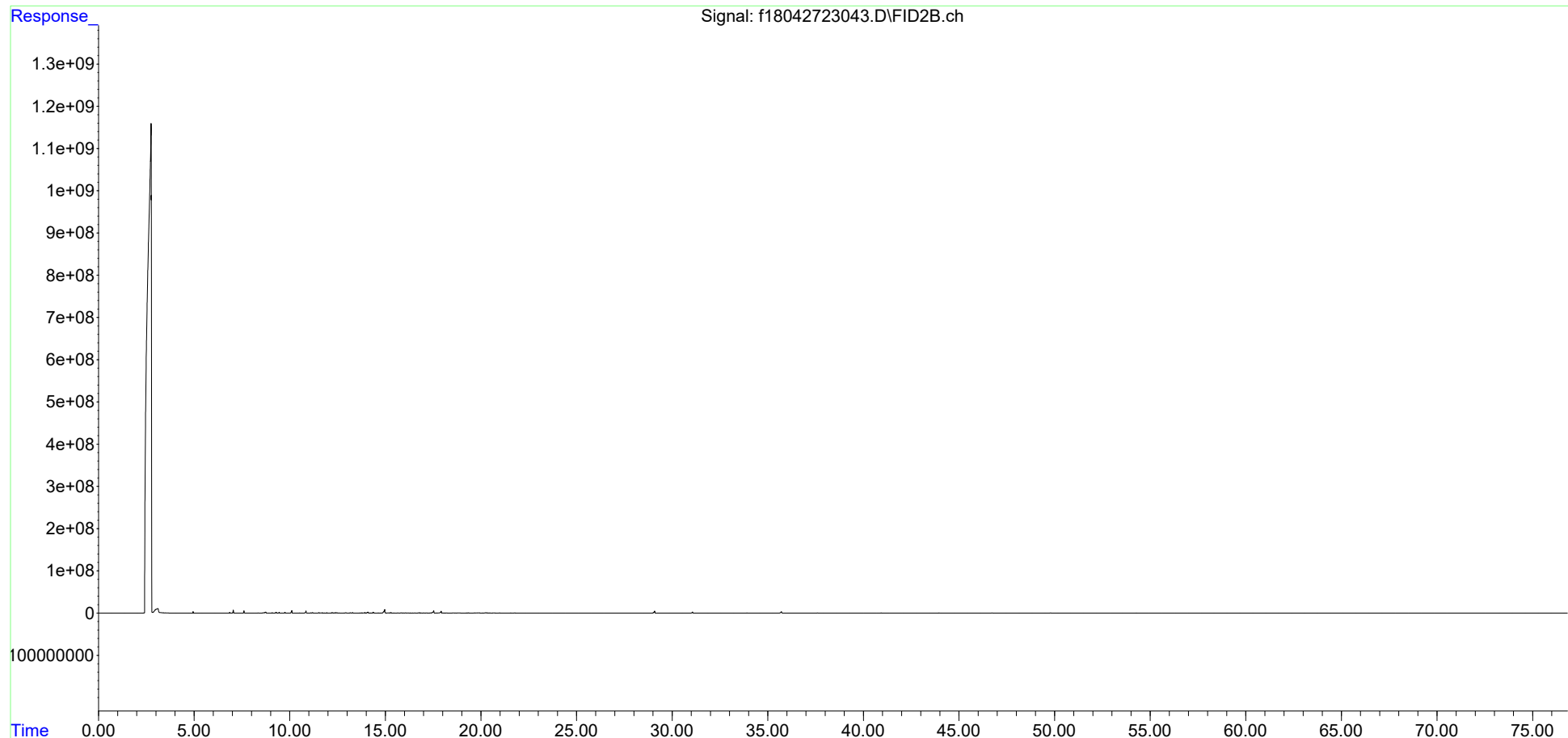

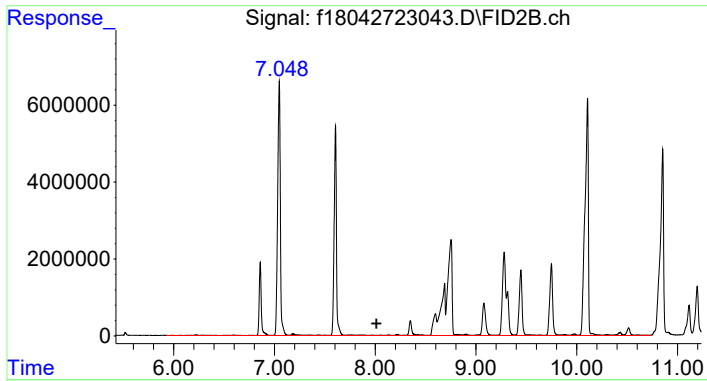

#4 > C8 to C10 Aliphatics

R.T.: 8.012 min  
 Delta R.T.: 0.000 min  
 Response: 677188641  
 Conc: 547.13 ug/mL m

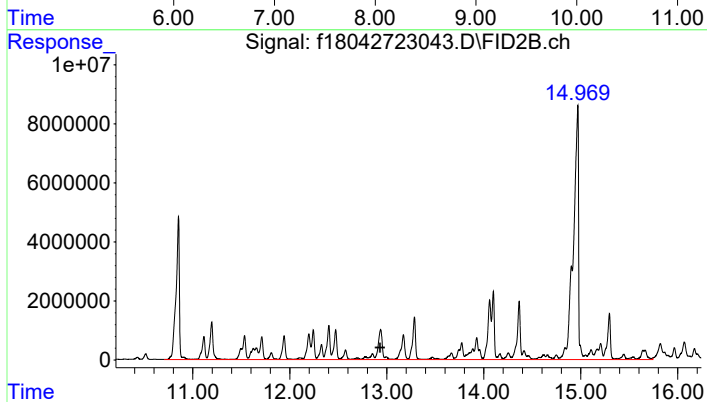

#5 > C10 to C12 Aliphatics

R.T.: 12.930 min  
 Delta R.T.: 0.000 min  
 Response: 1064940106  
 Conc: 860.41 ug/ml m

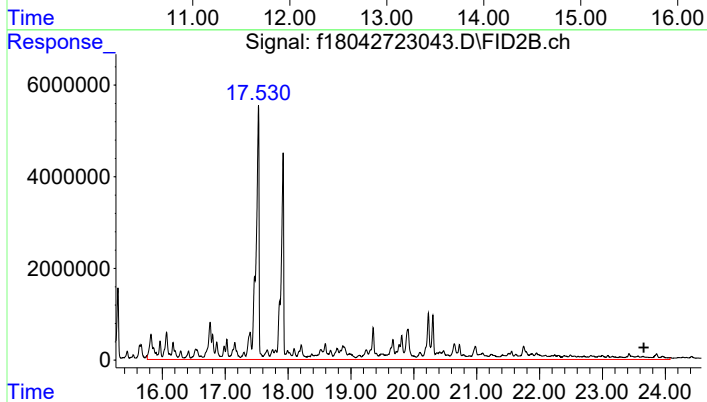

#6 > C12 to C16 Aliphatics

R.T.: 23.659 min  
 Delta R.T.: 0.000 min  
 Response: 973851106  
 Conc: 786.81 UG/ML m

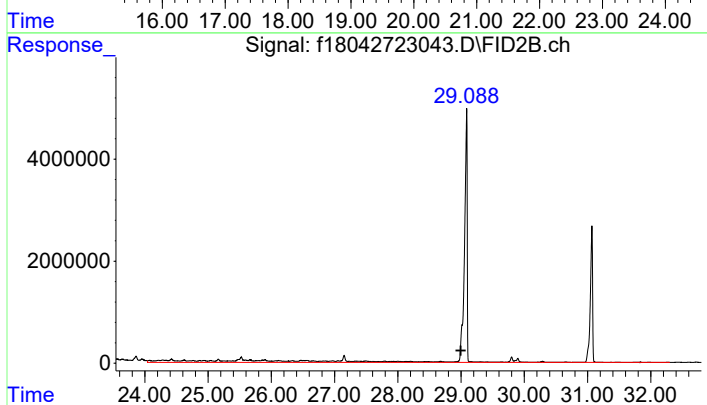

#7 > C16 to C21 Aliphatics

R.T.: 28.995 min  
 Delta R.T.: 0.000 min  
 Response: 96953118  
 Conc: 78.33 UG/ML m

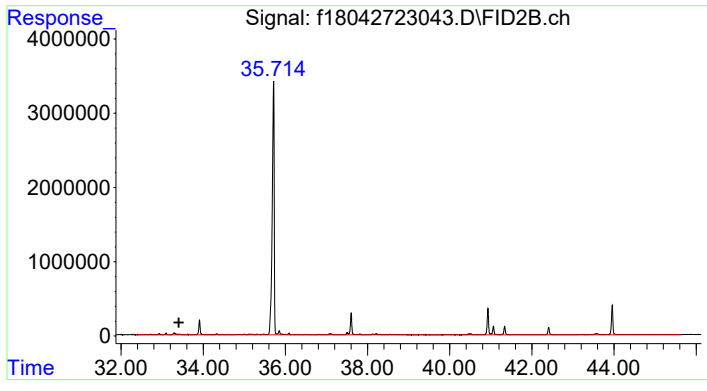

#8 > C21 to C32 Aliphatics

R.T.: 33.402 min  
Delta R.T.: 0.000 min  
Response: 67547811  
Conc: 54.57 UG/ML m

Data Path : C:\Projects\Hawaii DOH\2. Laboratory Data\Alpha\WAF Study\L2317027\TPH\NF TPH\  
 Data File : f18050823011.D  
 Signal(s) : FID2B.ch  
 Acq On : 08 May 2023 04:16 pm  
 Operator : FID18:AMV  
 Sample : L2317027-23F1  
 Misc : WG1776333,WG1771482,ICAL19877  
 ALS Vial : 56 Sample Multiplier: 1

Integration File: SHCINT2.E  
 Quant Time: May 29 22:31:01 2023  
 Quant Method : C:\Projects\Hawaii DOH\2. Laboratory Data\Alpha\WAF Study\L2317027\TPH\NF TPH\NF T  
 .. PH Quant.M  
 Quant Title : FID Forensics  
 QLast Update : Fri Sep 23 15:53:13 2022  
 Response via : Initial Calibration  
 Integrator: ChemStation

Volume Inj. : 1.0  
 Signal Phase : Rtx-5MS  
 Signal Info : 0.25mm

Blank Name : IB1805082301R  
 Blank File : f18050823009.D

Compound	R.T.	Response	Conc Units
-----			
Internal Standards			
1) I 5-alpha-androstane	30.943	62625273	50.000 ug/mL m
System Monitoring Compounds			
3) s d50-Tetracosane	35.602	107248716	103.605 ug/mL m
Spiked Amount 50.000	Range 50 - 130	Recovery	= 207.21%#
Target Compounds			
4) h > C8 to C10 Aliphatics	8.012	5518261	4.677 ug/mL m
5) h > C10 to C12 Aliphatics	12.930	4558164	3.863 ug/ml m
6) h > C12 to C16 Aliphatics	23.659	2510063	2.127 UG/ML m
7) h > C16 to C21 Aliphatics	28.995	4433803	3.758 UG/ML m
8) h > C21 to C32 Aliphatics	33.402	19275172	16.337 UG/ML m

SemiQuant Compounds - Not Calibrated on this Instrument

(f)=RT Delta > 1/2 Window

(m)=manual int.

Data Path : C:\Projects\Hawaii DOH\2. Laboratory Data\Alpha\WAF Study\L2317027\TPH\NF TPH\  
Data File : f18050823011.D  
Signal(s) : FID2B.ch  
Acq On : 08 May 2023 04:16 pm  
Operator : FID18:AMV  
Sample : L2317027-23F1  
Misc : WG1776333,WG1771482,ICAL19877  
ALS Vial : 56 Sample Multiplier: 1

Integration File: SHCINT2.E  
Quant Time: May 29 22:31:01 2023  
Quant Method : C:\Projects\Hawaii DOH\2. Laboratory Data\Alpha\WAF Study\L2317027\TPH\NF TPH\NF T  
... PH Quant.M  
Quant Title : FID Forensics  
QLast Update : Fri Sep 23 15:53:13 2022  
Response via : Initial Calibration  
Integrator: ChemStation

Volume Inj. : 1.0  
Signal Phase : Rtx-5MS  
Signal Info : 0.25mm

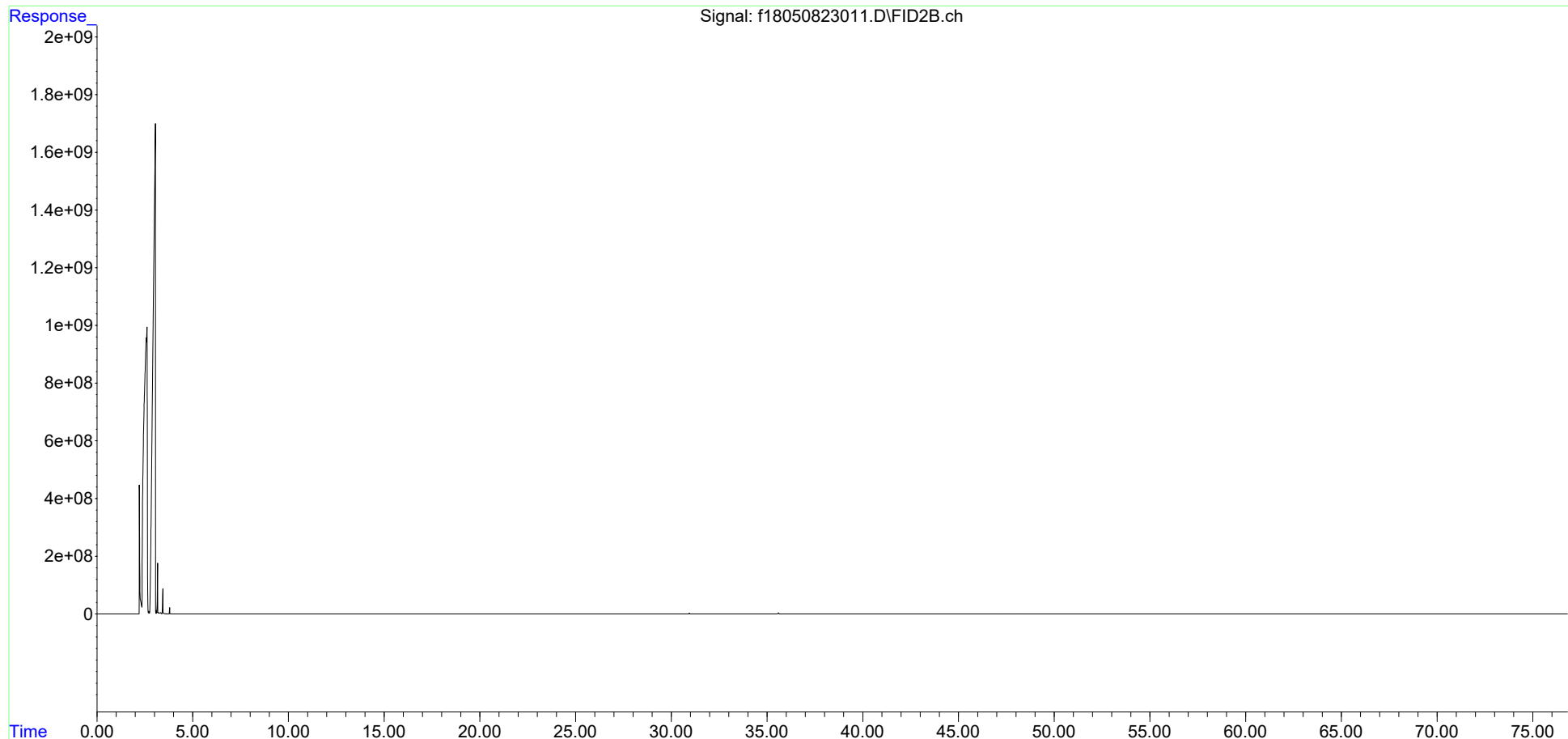

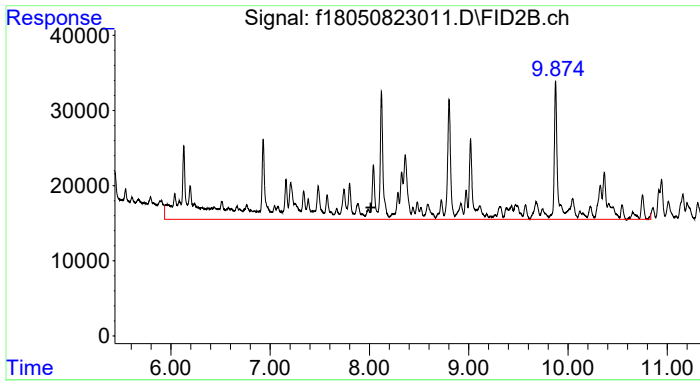

#4 > C8 to C10 Aliphatics

R.T.: 8.012 min  
 Delta R.T.: 0.000 min  
 Response: 5518261  
 Conc: 4.68 ug/mL m

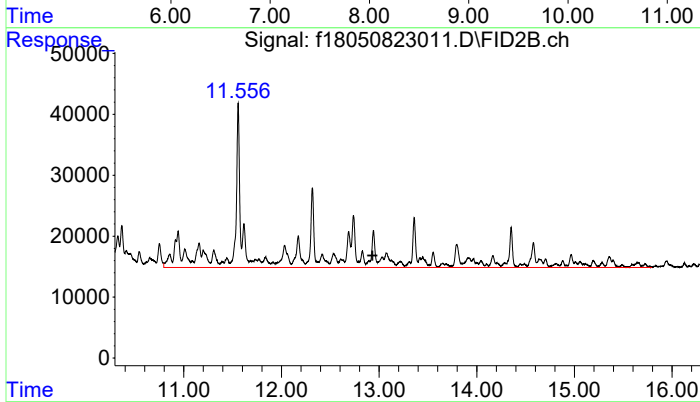

#5 > C10 to C12 Aliphatics

R.T.: 12.930 min  
 Delta R.T.: 0.000 min  
 Response: 4558164  
 Conc: 3.86 ug/ml m

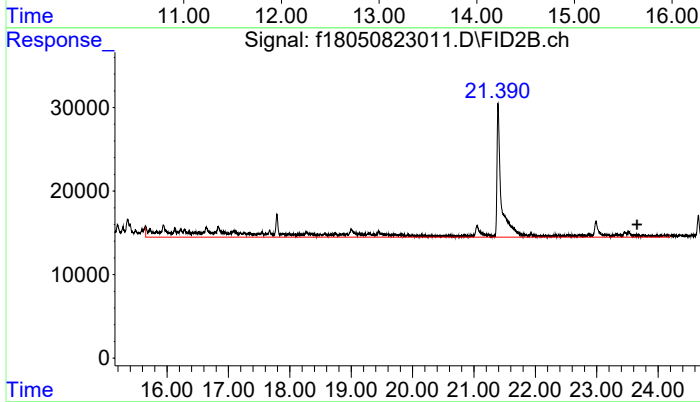

#6 > C12 to C16 Aliphatics

R.T.: 23.659 min  
 Delta R.T.: 0.000 min  
 Response: 2510063  
 Conc: 2.13 UG/ML m

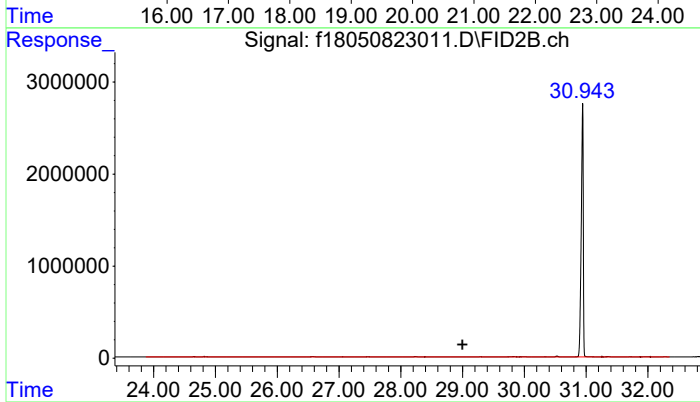

#7 > C16 to C21 Aliphatics

R.T.: 28.995 min  
 Delta R.T.: 0.000 min  
 Response: 4433803  
 Conc: 3.76 UG/ML m

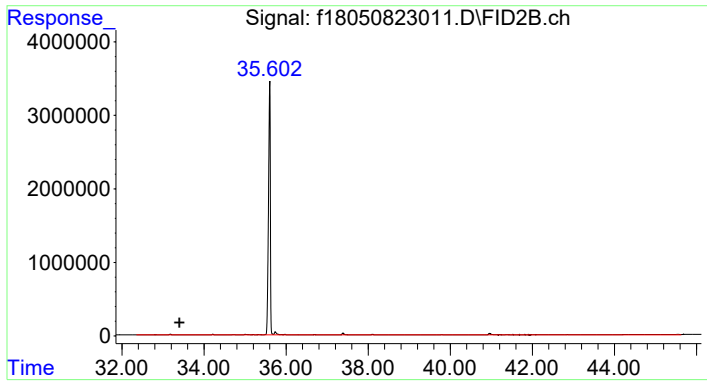

#8 > C21 to C32 Aliphatics

R.T.: 33.402 min  
Delta R.T.: 0.000 min  
Response: 19275172  
Conc: 16.34 UG/ML m



Data Path : C:\Projects\Hawaii DOH\2. Laboratory Data\Alpha\WAF Study\L2317027\TPH\NF TPH\  
 Data File : f18050823033.D  
 Signal(s) : FID2B.ch  
 Acq On : 09 May 2023 07:37 am  
 Operator : FID18:AMV  
 Sample : L2317027-24F2  
 Misc : WG1776333,WG1771483,ICAL19877  
 ALS Vial : 67 Sample Multiplier: 1

Integration File: SHCINT2.E  
 Quant Time: Jun 01 10:49:23 2023  
 Quant Method : C:\Projects\Hawaii DOH\2. Laboratory Data\Alpha\WAF Study\L2317027\TPH\NF TPH\NF T  
 .. PH Quant.M  
 Quant Title : FID Forensics  
 QLast Update : Fri Sep 23 15:53:13 2022  
 Response via : Initial Calibration  
 Integrator: ChemStation

Volume Inj. : 1.0  
 Signal Phase : Rtx-5MS  
 Signal Info : 0.25mm

Blank Name : IB1805082301R  
 Blank File : f18050823009.D

Compound	R.T.	Response	Conc Units
-----			
Internal Standards			
1) I 5-alpha-androstane	30.937	60780575	50.000 ug/mL m
System Monitoring Compounds			
2) s ortho-terphenyl	28.962	134068352	105.512 ug/mL m
Spiked Amount 50.000	Range 50 - 130	Recovery	= 211.02%#
Target Compounds			
9) h > C8 to C10 Aromatics	7.704	365052255	318.789 UG/ML m
10) h > C10 to C12 Aromatics	12.274	747572322	652.832 UG/ML m
11) h > C12 to C16 Aromatics	17.385	563953564	492.483 UG/ML m
12) h > C16 to C21 Aromatics	28.995	12336218	10.773 UG/ML m
13) h > C21 to C32 Aromatics	34.889	19759407	17.255 UG/ML m

SemiQuant Compounds - Not Calibrated on this Instrument

(f)=RT Delta > 1/2 Window

(m)=manual int.

Data Path : C:\Projects\Hawaii DOH\2. Laboratory Data\Alpha\WAF Study\L2317027\TPH\NF TPH\  
Data File : f18050823033.D  
Signal(s) : FID2B.ch  
Acq On : 09 May 2023 07:37 am  
Operator : FID18:AMV  
Sample : L2317027-24F2  
Misc : WG1776333,WG1771483,ICAL19877  
ALS Vial : 67 Sample Multiplier: 1

Integration File: SHCINT2.E  
Quant Time: Jun 01 10:49:23 2023  
Quant Method : C:\Projects\Hawaii DOH\2. Laboratory Data\Alpha\WAF Study\L2317027\TPH\NF TPH\NF T  
PH Quant.M  
Quant Title : FID Forensics  
QLast Update : Fri Sep 23 15:53:13 2022  
Response via : Initial Calibration  
Integrator: ChemStation

Volume Inj. : 1.0  
Signal Phase : Rtx-5MS  
Signal Info : 0.25mm

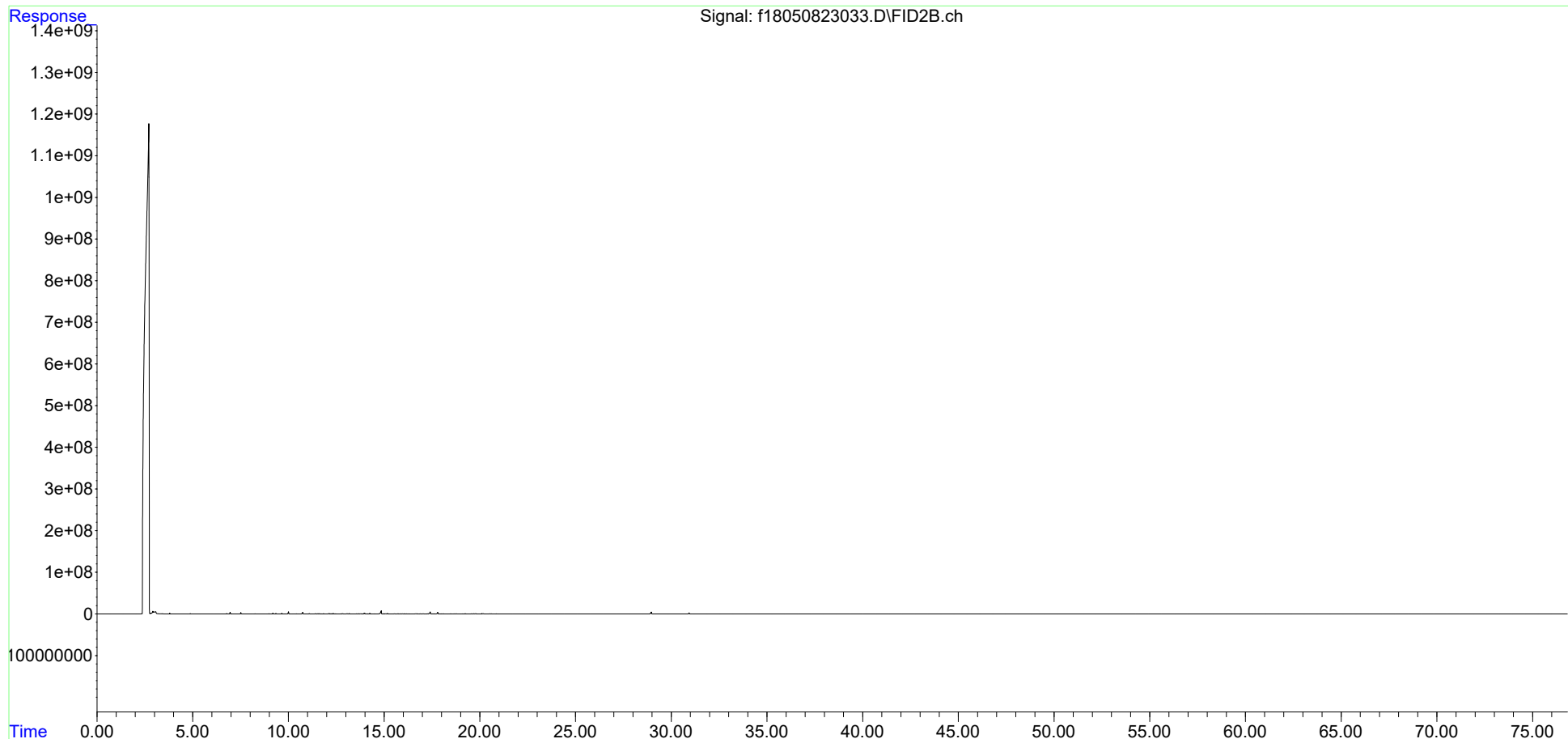

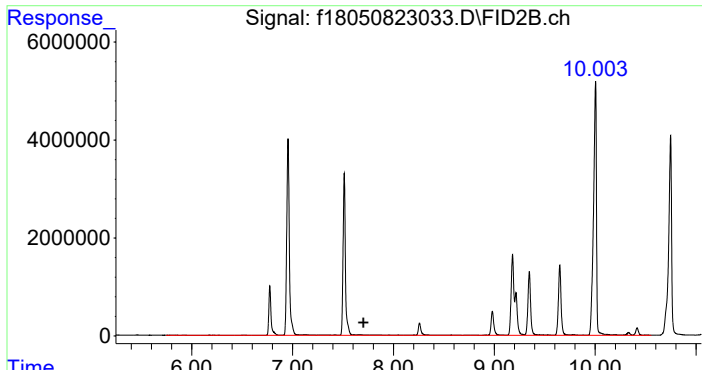

#9 > C8 to C10 Aromatics  
 R.T.: 7.704 min  
 Delta R.T.: 0.000 min  
 Response: 365052255  
 Conc: 318.79 UG/ML m

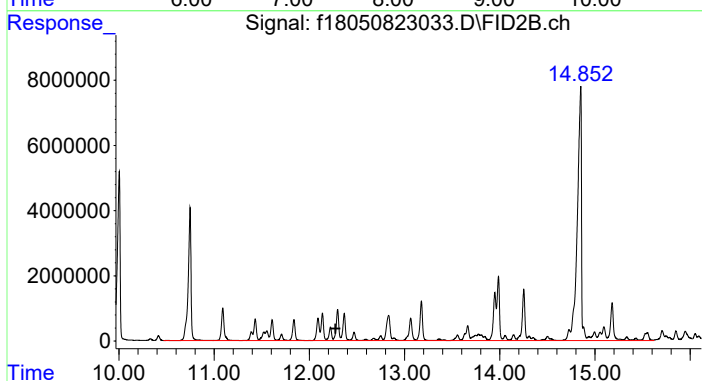

#10 > C10 to C12 Aromatics  
 R.T.: 12.274 min  
 Delta R.T.: 0.000 min  
 Response: 747572322  
 Conc: 652.83 UG/ML m

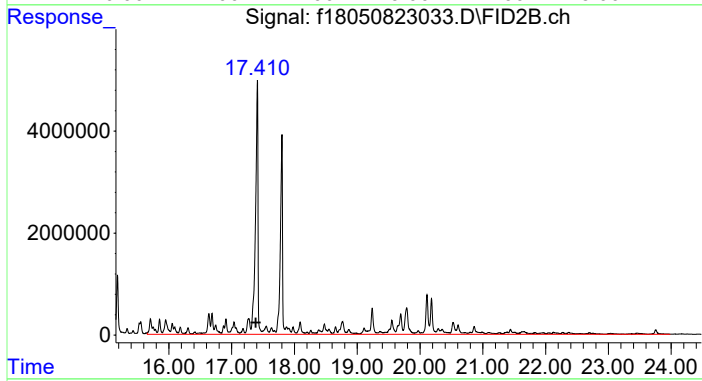

#11 > C12 to C16 Aromatics  
 R.T.: 17.385 min  
 Delta R.T.: 0.000 min  
 Response: 563953564  
 Conc: 492.48 UG/ML m

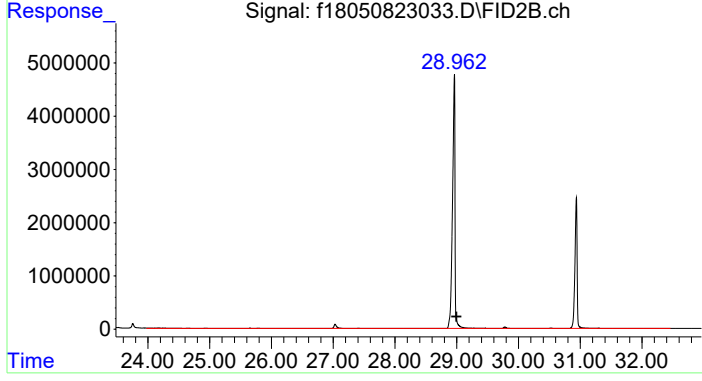

#12 > C16 to C21 Aromatics  
 R.T.: 28.995 min  
 Delta R.T.: 0.000 min  
 Response: 12336218  
 Conc: 10.77 UG/ML m

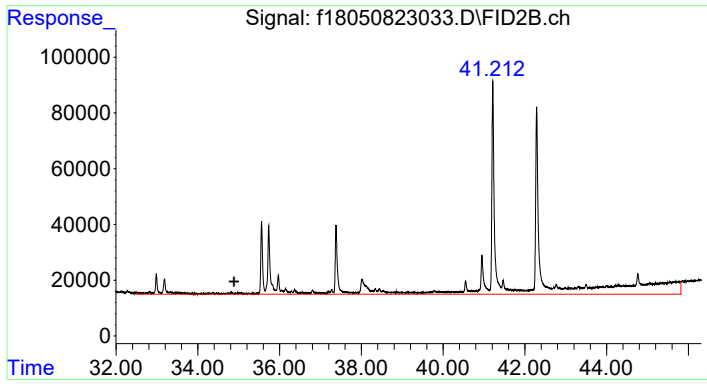

#13 > C21 to C32 Aromatics

R.T.: 34.889 min  
Delta R.T.: 0.000 min  
Response: 19759407  
Conc: 17.26 UG/ML m

Data Path : C:\Projects\Hawaii DOH\2. Laboratory Data\Alpha\WAF Study\L2317027\TPH\NF TPH\  
 Data File : f18042723053.D  
 Signal(s) : FID2B.ch  
 Acq On : 28 Apr 2023 10:10 pm  
 Operator : FID18:AMV  
 Sample : L2317027-25  
 Misc : WG1772069,WG1771320,ICAL19877  
 ALS Vial : 77 Sample Multiplier: 1

Integration File: SHCINT2.E  
 Quant Time: Jun 01 12:38:54 2023  
 Quant Method : C:\Projects\Hawaii DOH\2. Laboratory Data\Alpha\WAF Study\L2317027\TPH\NF TPH\NF T  
 .. PH Quant.M  
 Quant Title : FID Forensics  
 QLast Update : Fri Sep 23 15:53:13 2022  
 Response via : Initial Calibration  
 Integrator: ChemStation

Volume Inj. : 1.0  
 Signal Phase : Rtx-5MS  
 Signal Info : 0.25mm

Blank Name : IB1804272302R  
 Blank File : f18042723039.D

Compound	R.T.	Response	Conc Units
Internal Standards			
1) I 5-alpha-androstane	31.066	62448696	50.000 ug/mL m
System Monitoring Compounds			
2) s ortho-terphenyl	29.089	146122549	111.927 ug/mL m
Spiked Amount 50.000	Range 50 - 130	Recovery = 223.85%#	
3) s d50-Tetracosane	35.718	117583473	113.909 ug/mL m
Spiked Amount 50.000	Range 50 - 130	Recovery = 227.82%#	
Target Compounds			
4) h > C8 to C10 Aliphatics	8.012	639411782	543.463 ug/mL m
5) h > C10 to C12 Aliphatics	12.930	1104184186	938.493 ug/ml m
6) h > C12 to C16 Aliphatics	23.659	918994092	781.092 UG/ML m
7) h > C16 to C21 Aliphatics	28.995	77073469	65.508 UG/ML m
8) h > C21 to C32 Aliphatics	33.402	32253661	27.414 UG/ML m

SemiQuant Compounds - Not Calibrated on this Instrument

(f)=RT Delta > 1/2 Window

(m)=manual int.

Data Path : C:\Projects\Hawaii DOH\2. Laboratory Data\Alpha\WAF Study\L2317027\TPH\NF TPH\  
Data File : f18042723053.D  
Signal(s) : FID2B.ch  
Acq On : 28 Apr 2023 10:10 pm  
Operator : FID18:AMV  
Sample : L2317027-25  
Misc : WG1772069,WG1771320,ICAL19877  
ALS Vial : 77 Sample Multiplier: 1

Integration File: SHCINT2.E  
Quant Time: Jun 01 12:38:54 2023  
Quant Method : C:\Projects\Hawaii DOH\2. Laboratory Data\Alpha\WAF Study\L2317027\TPH\NF TPH\NF T  
... PH Quant.M  
Quant Title : FID Forensics  
QLast Update : Fri Sep 23 15:53:13 2022  
Response via : Initial Calibration  
Integrator: ChemStation

Volume Inj. : 1.0  
Signal Phase : Rtx-5MS  
Signal Info : 0.25mm

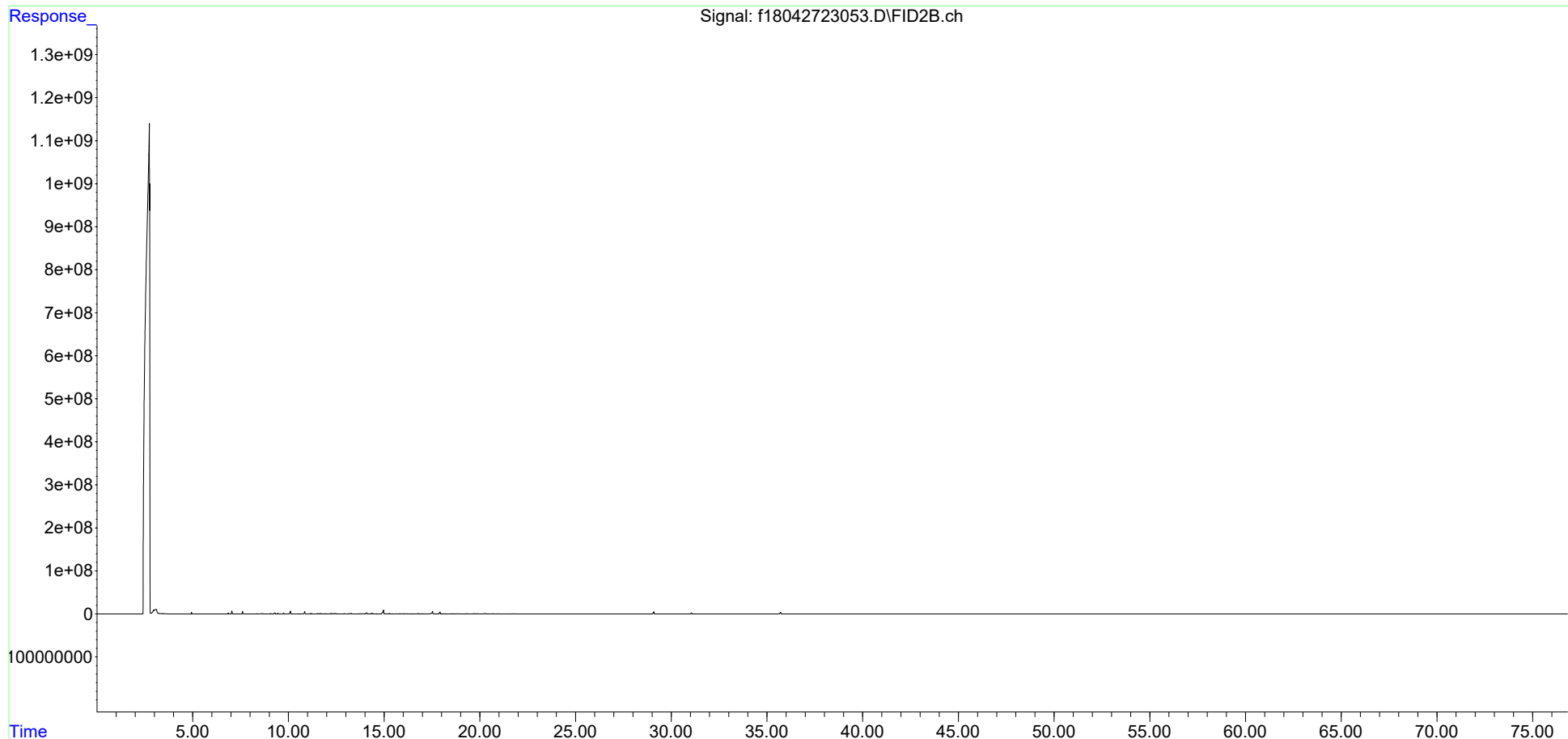

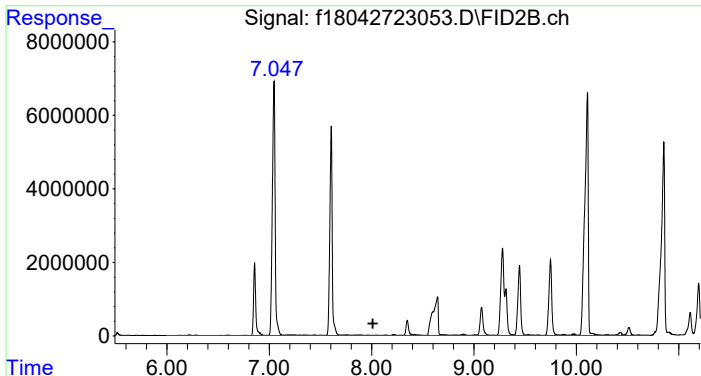

#4 > C8 to C10 Aliphatics

R.T.: 8.012 min  
 Delta R.T.: 0.000 min  
 Response: 639411782  
 Conc: 543.46 ug/mL m

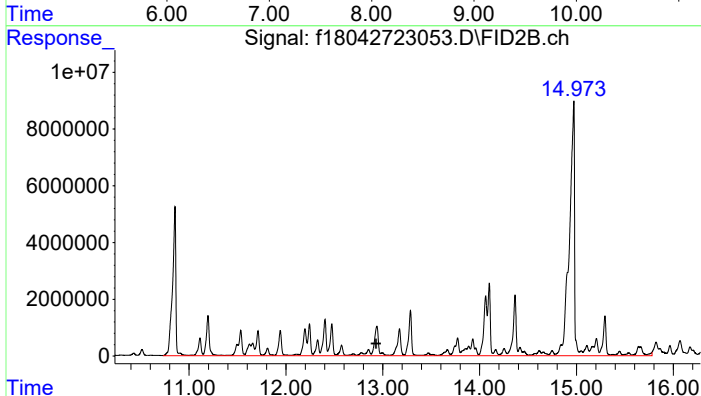

#5 > C10 to C12 Aliphatics

R.T.: 12.930 min  
 Delta R.T.: 0.000 min  
 Response: 1104184186  
 Conc: 938.49 ug/ml m

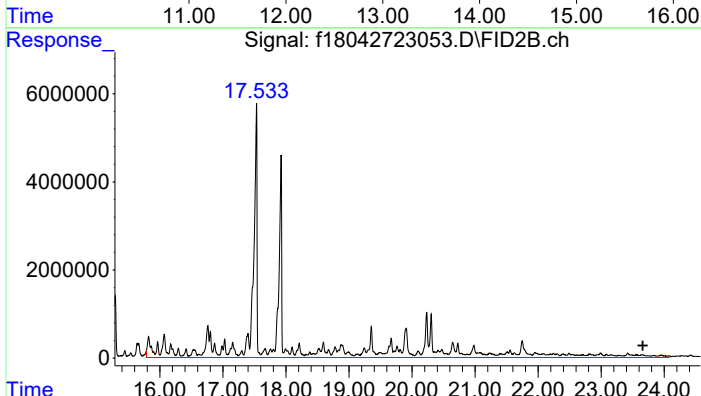

#6 > C12 to C16 Aliphatics

R.T.: 23.659 min  
 Delta R.T.: 0.000 min  
 Response: 918994092  
 Conc: 781.09 UG/ML m

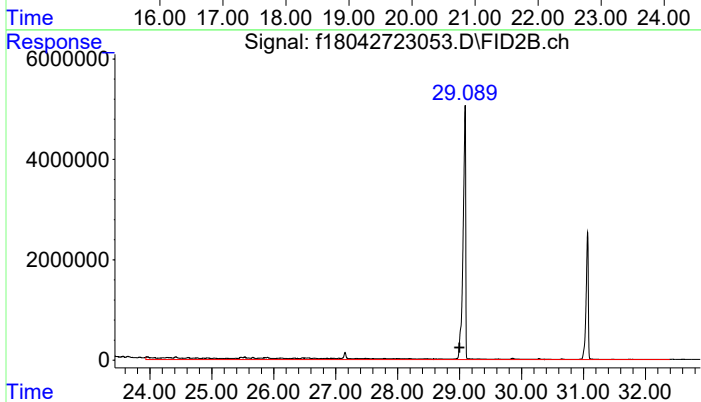

#7 > C16 to C21 Aliphatics

R.T.: 28.995 min  
 Delta R.T.: 0.000 min  
 Response: 77073469  
 Conc: 65.51 UG/ML m

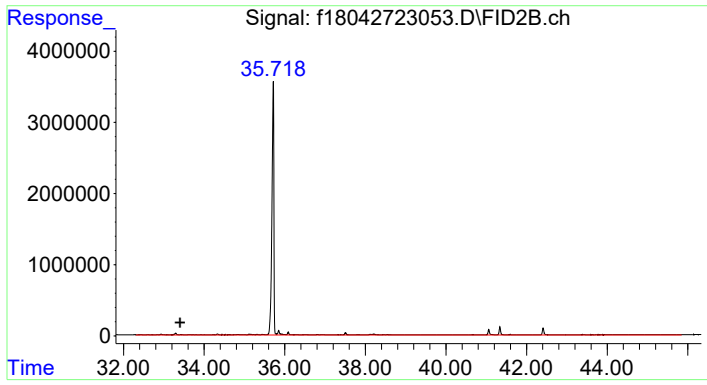

#8 > C21 to C32 Aliphatics

R.T.: 33.402 min  
Delta R.T.: 0.000 min  
Response: 32253661  
Conc: 27.41 UG/ML m



Data Path : C:\Projects\Hawaii DOH\2. Laboratory Data\Alpha\WAF Study\L2317027\TPH\NF TPH\  
 Data File : f18050823013.D  
 Signal(s) : FID2B.ch  
 Acq On : 08 May 2023 05:39 pm  
 Operator : FID18:AMV  
 Sample : L2317027-26F1  
 Misc : WG1776333,WG1771484,ICAL19877  
 ALS Vial : 57 Sample Multiplier: 1

Integration File: SHCINT2.E  
 Quant Time: May 29 22:33:45 2023  
 Quant Method : C:\Projects\Hawaii DOH\2. Laboratory Data\Alpha\WAF Study\L2317027\TPH\NF TPH\NF T  
 .. PH Quant.M  
 Quant Title : FID Forensics  
 QLast Update : Fri Sep 23 15:53:13 2022  
 Response via : Initial Calibration  
 Integrator: ChemStation

Volume Inj. : 1.0  
 Signal Phase : Rtx-5MS  
 Signal Info : 0.25mm

Blank Name : IB1805082301R  
 Blank File : f18050823009.D

Compound	R.T.	Response	Conc Units
-----			
Internal Standards			
1) I 5-alpha-androstane	30.942	65575878	50.000 ug/mL m
System Monitoring Compounds			
3) s d50-Tetracosane	35.602	115144461	106.227 ug/mL m
Spiked Amount 50.000	Range 50 - 130	Recovery	= 212.45%#
Target Compounds			
4) h > C8 to C10 Aliphatics	8.012	14025136	11.352 ug/mL m
5) h > C10 to C12 Aliphatics	12.930	6569803	5.318 ug/ml m
6) h > C12 to C16 Aliphatics	23.659	2527210	2.046 UG/ML m
7) h > C16 to C21 Aliphatics	28.995	2734323	2.213 UG/ML m
8) h > C21 to C32 Aliphatics	33.402	18919325	15.313 UG/ML m

SemiQuant Compounds - Not Calibrated on this Instrument

(f)=RT Delta > 1/2 Window

(m)=manual int.

Data Path : C:\Projects\Hawaii DOH\2. Laboratory Data\Alpha\WAF Study\L2317027\TPH\NF TPH\  
Data File : f18050823013.D  
Signal(s) : FID2B.ch  
Acq On : 08 May 2023 05:39 pm  
Operator : FID18:AMV  
Sample : L2317027-26F1  
Misc : WG1776333, WG1771484, ICAL19877  
ALS Vial : 57 Sample Multiplier: 1

Integration File: SHCINT2.E  
Quant Time: May 29 22:33:45 2023  
Quant Method : C:\Projects\Hawaii DOH\2. Laboratory Data\Alpha\WAF Study\L2317027\TPH\NF TPH\NF T  
PH Quant.M  
Quant Title : FID Forensics  
QLast Update : Fri Sep 23 15:53:13 2022  
Response via : Initial Calibration  
Integrator: ChemStation

Volume Inj. : 1.0  
Signal Phase : Rtx-5MS  
Signal Info : 0.25mm

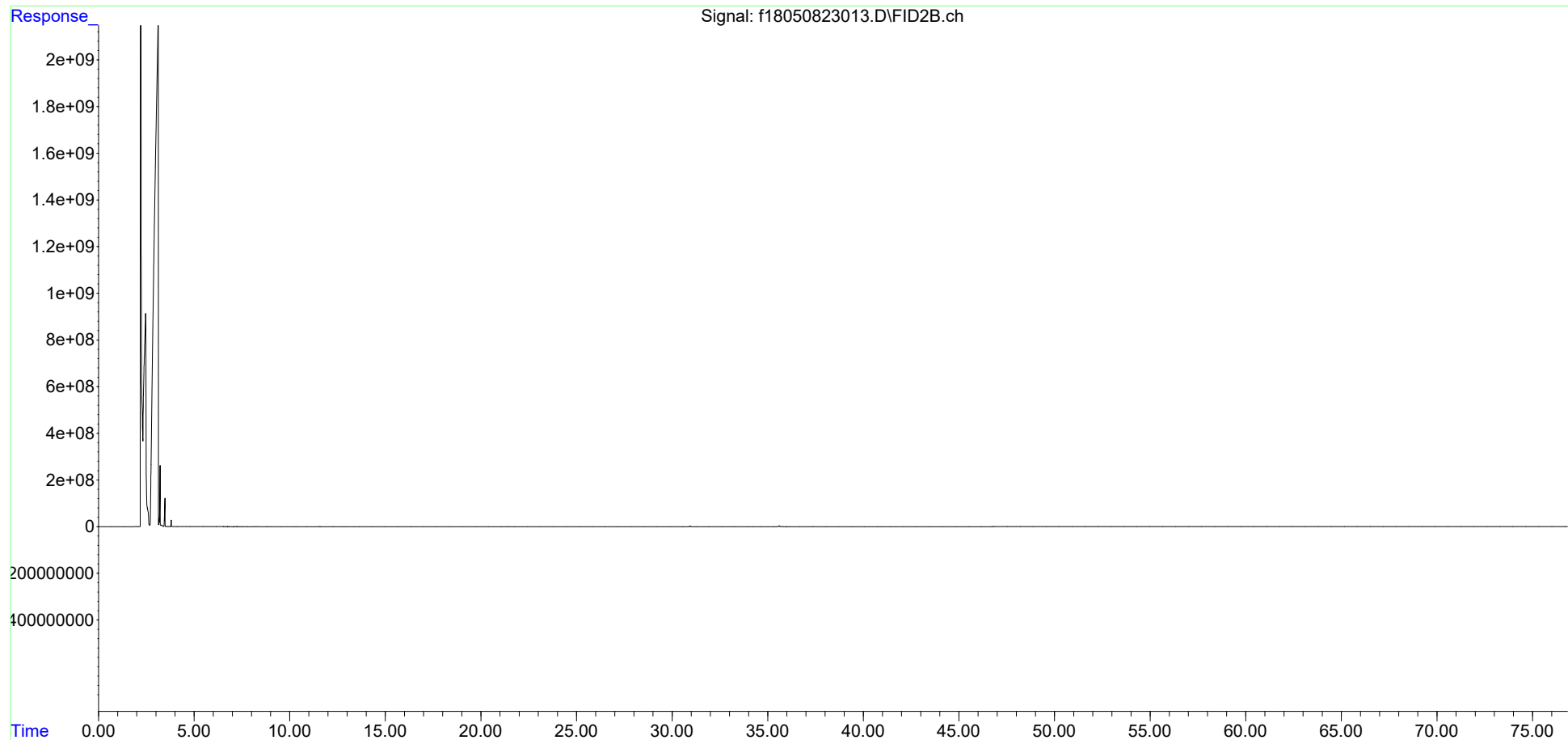

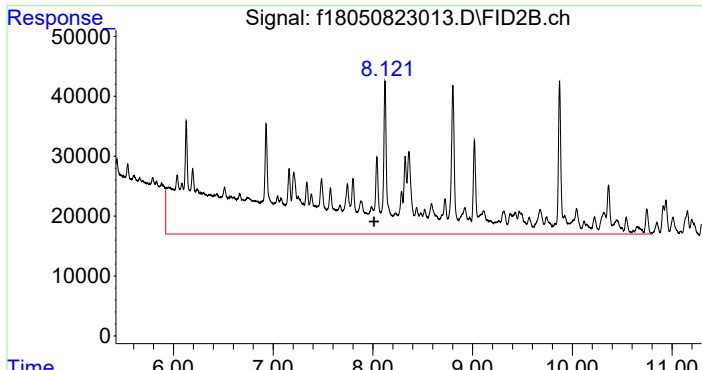

#4 > C8 to C10 Aliphatics  
 R.T.: 8.012 min  
 Delta R.T.: 0.000 min  
 Response: 14025136  
 Conc: 11.35 ug/mL m

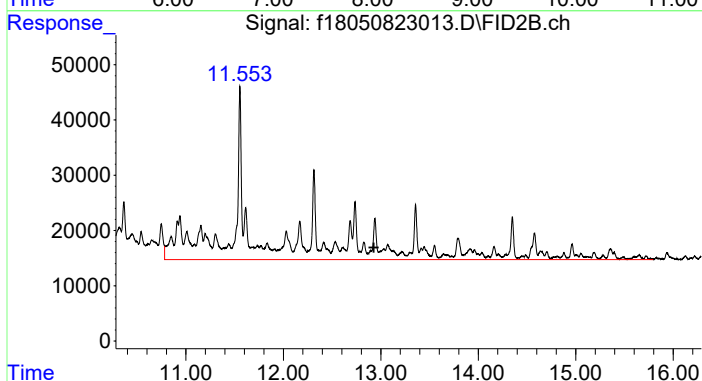

#5 > C10 to C12 Aliphatics  
 R.T.: 12.930 min  
 Delta R.T.: 0.000 min  
 Response: 6569803  
 Conc: 5.32 ug/ml m

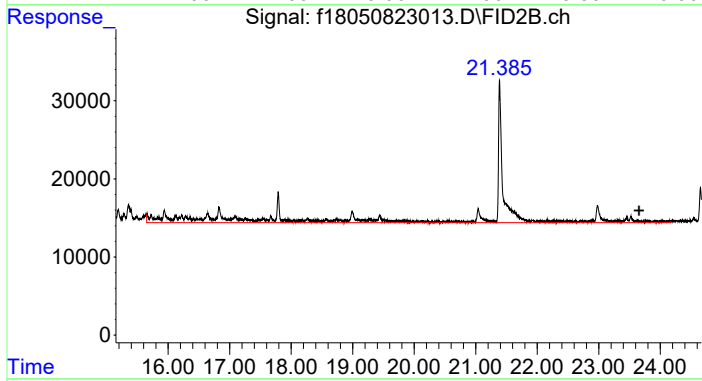

#6 > C12 to C16 Aliphatics  
 R.T.: 23.659 min  
 Delta R.T.: 0.000 min  
 Response: 2527210  
 Conc: 2.05 UG/ML m

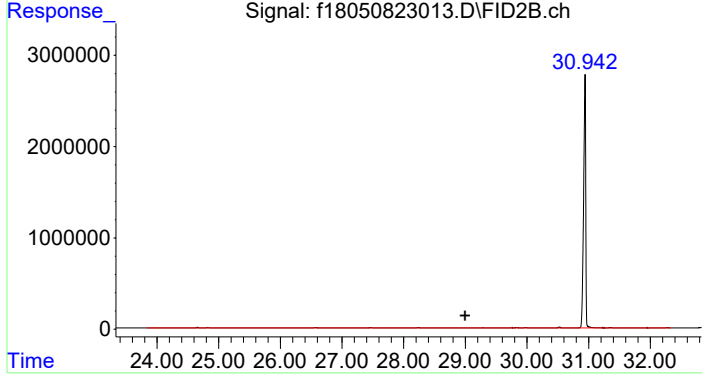

#7 > C16 to C21 Aliphatics  
 R.T.: 28.995 min  
 Delta R.T.: 0.000 min  
 Response: 2734323  
 Conc: 2.21 UG/ML m

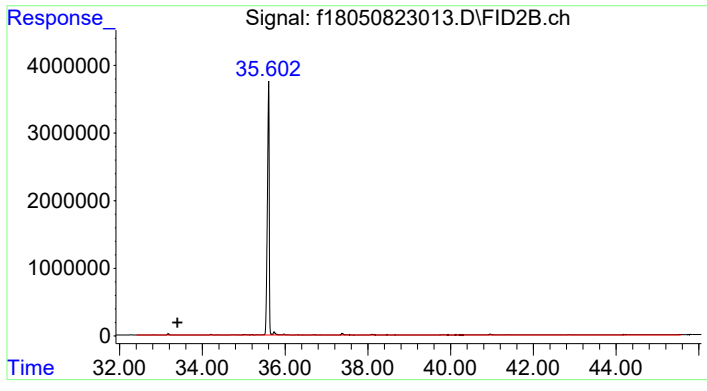

#8 > C21 to C32 Aliphatics

R.T.: 33.402 min  
Delta R.T.: 0.000 min  
Response: 18919325  
Conc: 15.31 UG/ML m

Data Path : C:\Projects\Hawaii DOH\2. Laboratory Data\Alpha\WAF Study\L2317027\TPH\NF TPH\  
 Data File : f18050823041.D  
 Signal(s) : FID2B.ch  
 Acq On : 09 May 2023 01:13 pm  
 Operator : FID18:AMV  
 Sample : L2317027-27F2  
 Misc : WG1776333,WG1771485,ICAL19877  
 ALS Vial : 71 Sample Multiplier: 1

Integration File: SHCINT2.E  
 Quant Time: Jun 01 10:52:31 2023  
 Quant Method : C:\Projects\Hawaii DOH\2. Laboratory Data\Alpha\WAF Study\L2317027\TPH\NF TPH\NF T  
 .. PH Quant.M  
 Quant Title : FID Forensics  
 QLast Update : Fri Sep 23 15:53:13 2022  
 Response via : Initial Calibration  
 Integrator: ChemStation

Volume Inj. : 1.0  
 Signal Phase : Rtx-5MS  
 Signal Info : 0.25mm

Blank Name : IB1805082302R  
 Blank File : f18050823039.D

Compound	R.T.	Response	Conc Units
-----			
Internal Standards			
1) I 5-alpha-androstane	30.938	61838272	50.000 ug/mL m
System Monitoring Compounds			
2) s ortho-terphenyl	28.962	140402900	108.607 ug/mL m
Spiked Amount 50.000	Range 50 - 130	Recovery	= 217.21%#
Target Compounds			
9) h > C8 to C10 Aromatics	7.704	412926022	354.428 UG/ML m
10) h > C10 to C12 Aromatics	12.274	793180466	680.813 UG/ML m
11) h > C12 to C16 Aromatics	17.385	522951239	448.866 UG/ML m
12) h > C16 to C21 Aromatics	28.995	11736701	10.074 UG/ML m
13) h > C21 to C32 Aromatics	34.889	24021667	20.619 UG/ML m

SemiQuant Compounds - Not Calibrated on this Instrument

(f)=RT Delta > 1/2 Window

(m)=manual int.

Data Path : C:\Projects\Hawaii DOH\2. Laboratory Data\Alpha\WAF Study\L2317027\TPH\NF TPH\  
Data File : f18050823041.D  
Signal(s) : FID2B.ch  
Acq On : 09 May 2023 01:13 pm  
Operator : FID18:AMV  
Sample : L2317027-27F2  
Misc : WG1776333, WG1771485, ICAL19877  
ALS Vial : 71 Sample Multiplier: 1

Integration File: SHCINT2.E  
Quant Time: Jun 01 10:52:31 2023  
Quant Method : C:\Projects\Hawaii DOH\2. Laboratory Data\Alpha\WAF Study\L2317027\TPH\NF TPH\NF T  
PH Quant.M  
Quant Title : FID Forensics  
QLast Update : Fri Sep 23 15:53:13 2022  
Response via : Initial Calibration  
Integrator: ChemStation

Volume Inj. : 1.0  
Signal Phase : Rtx-5MS  
Signal Info : 0.25mm

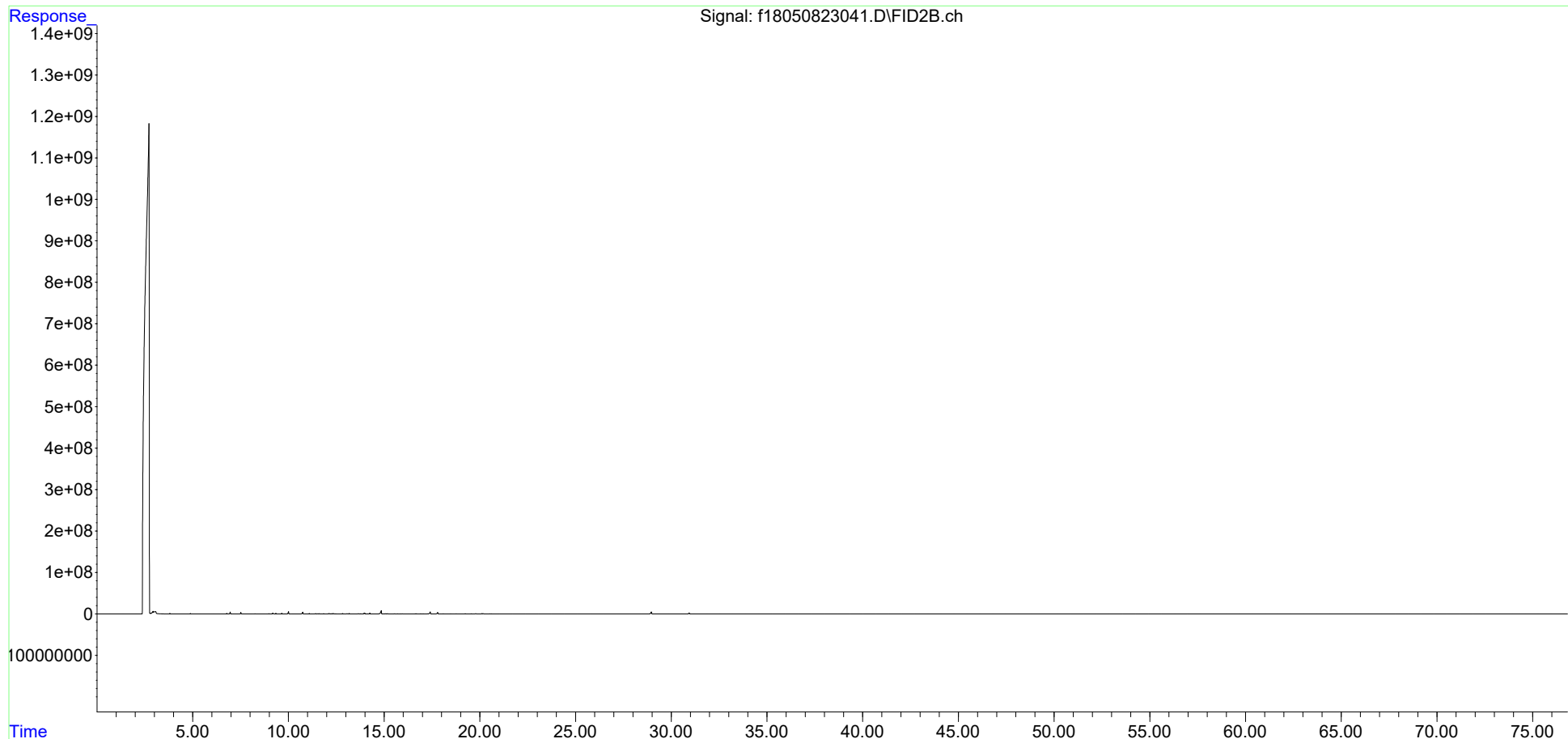

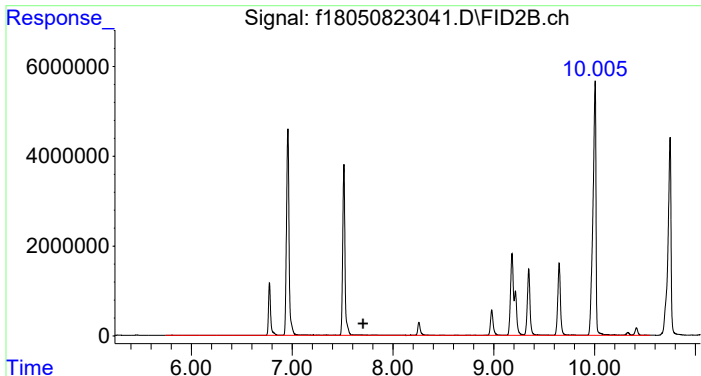

#9 > C8 to C10 Aromatics  
 R.T.: 7.704 min  
 Delta R.T.: 0.000 min  
 Response: 412926022  
 Conc: 354.43 UG/ML m

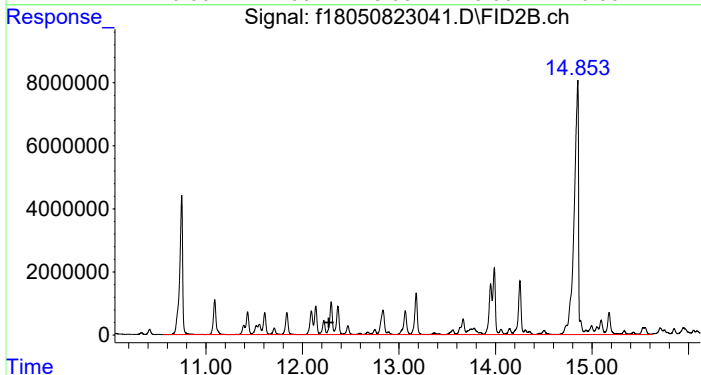

#10 > C10 to C12 Aromatics  
 R.T.: 12.274 min  
 Delta R.T.: 0.000 min  
 Response: 793180466  
 Conc: 680.81 UG/ML m

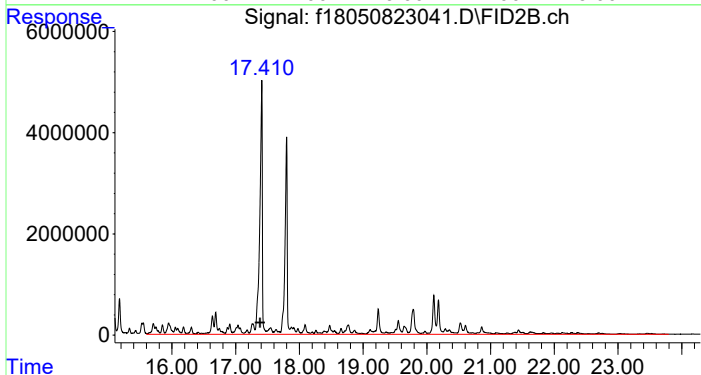

#11 > C12 to C16 Aromatics  
 R.T.: 17.385 min  
 Delta R.T.: 0.000 min  
 Response: 522951239  
 Conc: 448.87 UG/ML m

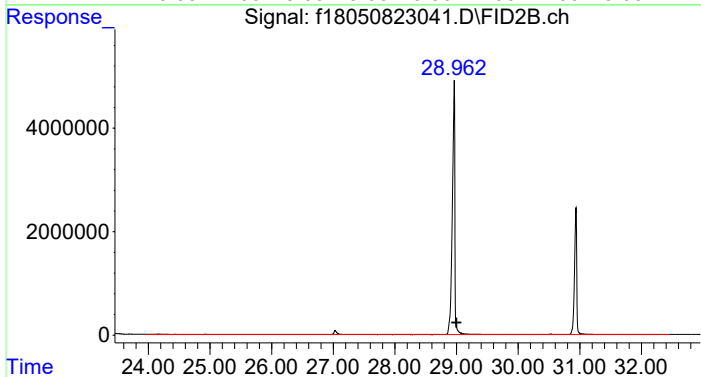

#12 > C16 to C21 Aromatics  
 R.T.: 28.995 min  
 Delta R.T.: 0.000 min  
 Response: 11736701  
 Conc: 10.07 UG/ML m

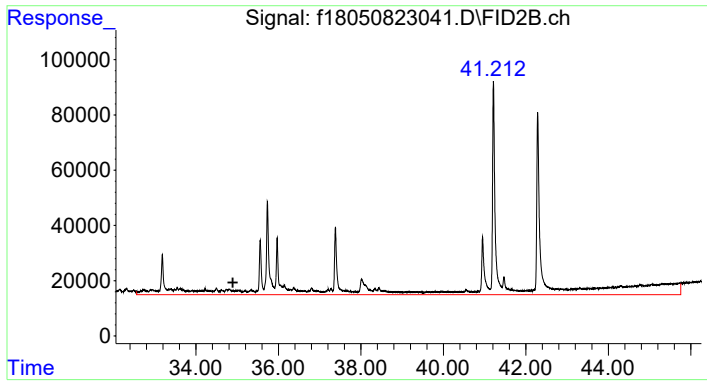

#13 > C21 to C32 Aromatics

R.T.: 34.889 min  
Delta R.T.: 0.000 min  
Response: 24021667  
Conc: 20.62 UG/ML m



Data Path : C:\Projects\Hawaii DOH\2. Laboratory Data\Alpha\WAF Study\L2317027\TPH\NF TPH\  
 Data File : f18042723055.D  
 Signal(s) : FID2B.ch  
 Acq On : 28 Apr 2023 11:34 pm  
 Operator : FID18:AMV  
 Sample : L2317027-28  
 Misc : WG1772069,WG1771320,ICAL19877  
 ALS Vial : 78 Sample Multiplier: 1

Integration File: SHCINT2.E

Quant Time: Jun 01 12:44:06 2023

Quant Method : C:\Projects\Hawaii DOH\2. Laboratory Data\Alpha\WAF Study\L2317027\TPH\NF TPH\NF T  
 PH Quant.M

Quant Title : FID Forensics

QLast Update : Fri Sep 23 15:53:13 2022

Response via : Initial Calibration

Integrator: ChemStation

Volume Inj. : 1.0

Signal Phase : Rtx-5MS

Signal Info : 0.25mm

Blank Name : IB1804272302R

Blank File : f18042723039.D

Compound	R.T.	Response	Conc Units
Internal Standards			
1) I 5-alpha-androstane	31.068	66208863	50.000 ug/mL m
System Monitoring Compounds			
2) s ortho-terphenyl	29.092	157684680	113.923 ug/mL m
Spiked Amount 50.000 Range	50 - 130	Recovery =	227.85%#
3) s d50-Tetracosane	35.720	126195959	115.310 ug/mL m
Spiked Amount 50.000 Range	50 - 130	Recovery =	230.62%#
Target Compounds			
4) h > C8 to C10 Aliphatics	8.012	798158712	639.862 ug/mL m
5) h > C10 to C12 Aliphatics	12.930	1207159739	967.746 ug/ml m
6) h > C12 to C16 Aliphatics	23.659	1059696815	849.529 UG/ML m
7) h > C16 to C21 Aliphatics	28.995	106500895	85.379 UG/ML m
8) h > C21 to C32 Aliphatics	33.402	85622710	68.641 UG/ML m

SemiQuant Compounds - Not Calibrated on this Instrument

(f)=RT Delta > 1/2 Window

(m)=manual int.

Data Path : C:\Projects\Hawaii DOH\2. Laboratory Data\Alpha\WAF Study\L2317027\TPH\NF TPH\  
Data File : f18042723055.D  
Signal(s) : FID2B.ch  
Acq On : 28 Apr 2023 11:34 pm  
Operator : FID18:AMV  
Sample : L2317027-28  
Misc : WG1772069,WG1771320,ICAL19877  
ALS Vial : 78 Sample Multiplier: 1

Integration File: SHCINT2.E  
Quant Time: Jun 01 12:44:06 2023  
Quant Method : C:\Projects\Hawaii DOH\2. Laboratory Data\Alpha\WAF Study\L2317027\TPH\NF TPH\NF T  
... PH Quant.M  
Quant Title : FID Forensics  
QLast Update : Fri Sep 23 15:53:13 2022  
Response via : Initial Calibration  
Integrator: ChemStation

Volume Inj. : 1.0  
Signal Phase : Rtx-5MS  
Signal Info : 0.25mm

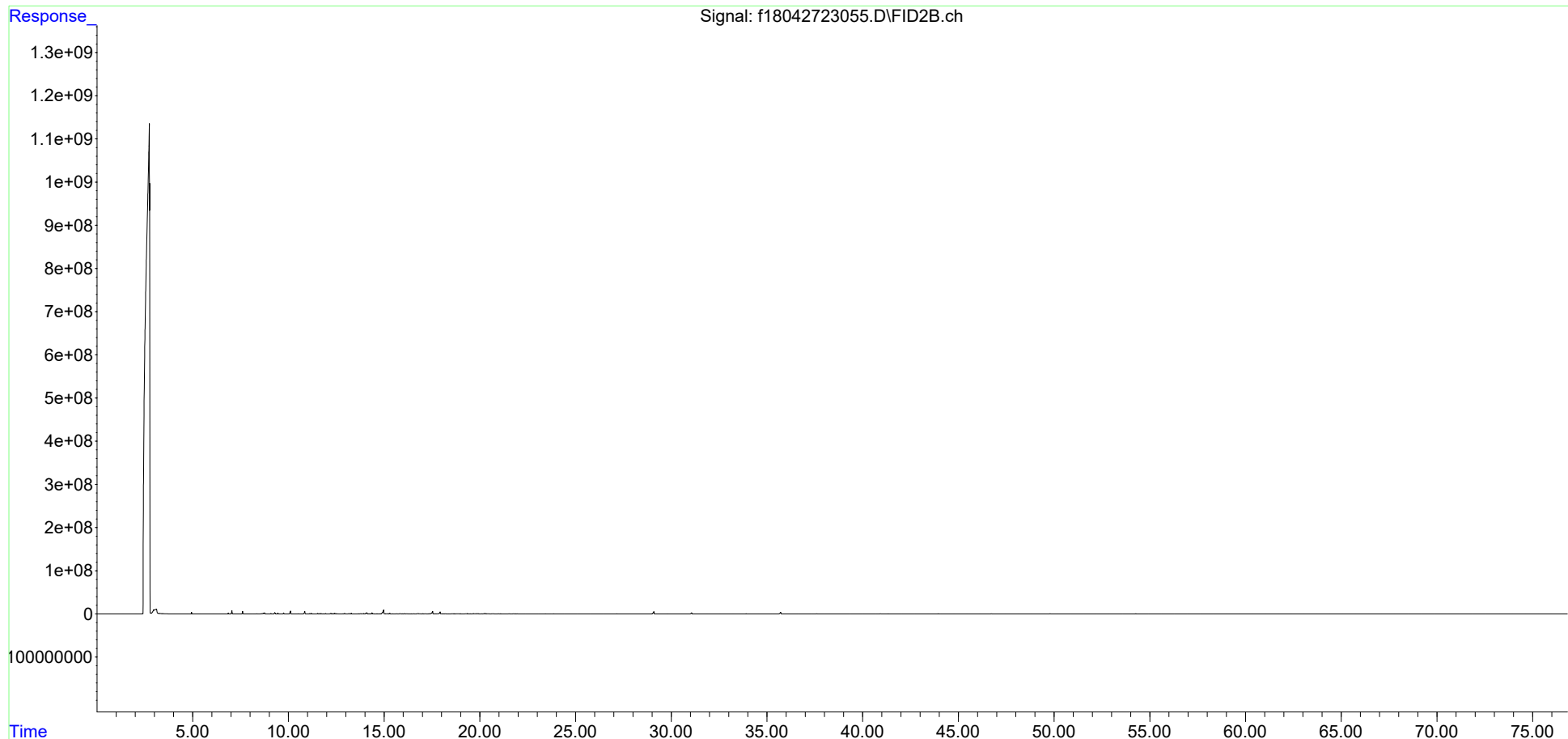

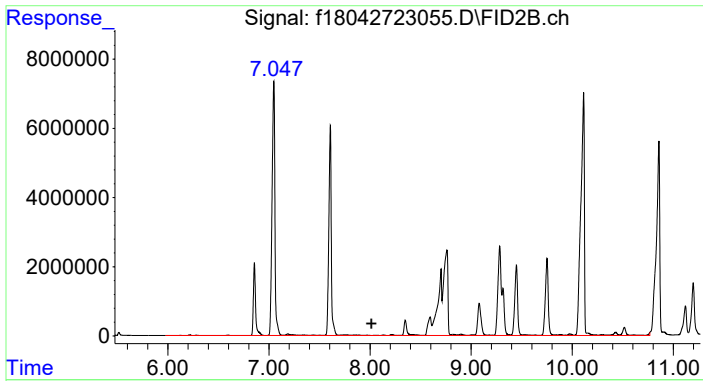

#4 > C8 to C10 Aliphatics

R.T.: 8.012 min  
 Delta R.T.: 0.000 min  
 Response: 798158712  
 Conc: 639.86 ug/mL m

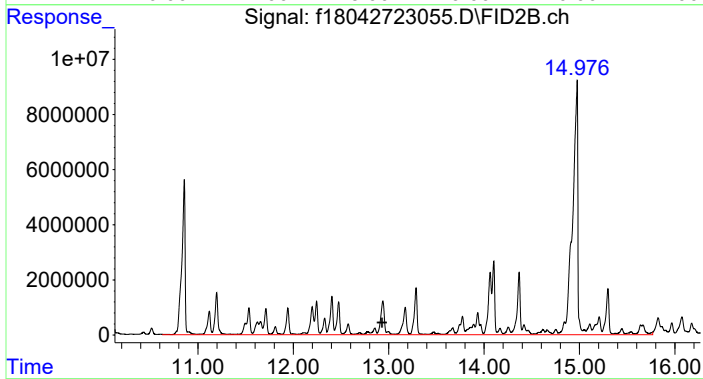

#5 > C10 to C12 Aliphatics

R.T.: 12.930 min  
 Delta R.T.: 0.000 min  
 Response: 1207159739  
 Conc: 967.75 ug/ml m

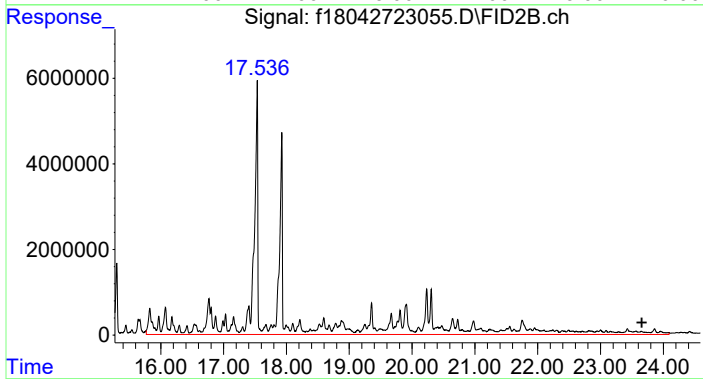

#6 > C12 to C16 Aliphatics

R.T.: 23.659 min  
 Delta R.T.: 0.000 min  
 Response: 1059696815  
 Conc: 849.53 UG/ML m

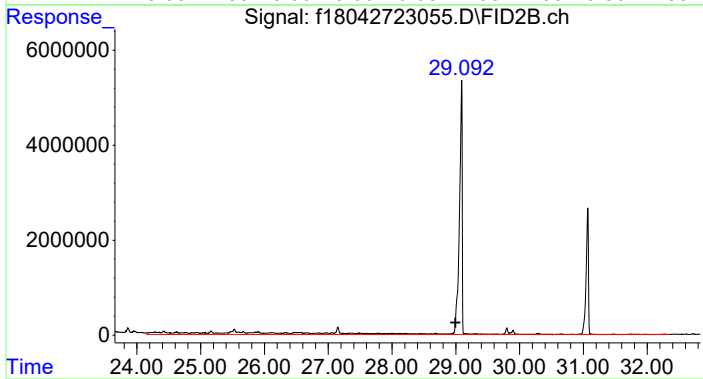

#7 > C16 to C21 Aliphatics

R.T.: 28.995 min  
 Delta R.T.: 0.000 min  
 Response: 106500895  
 Conc: 85.38 UG/ML m

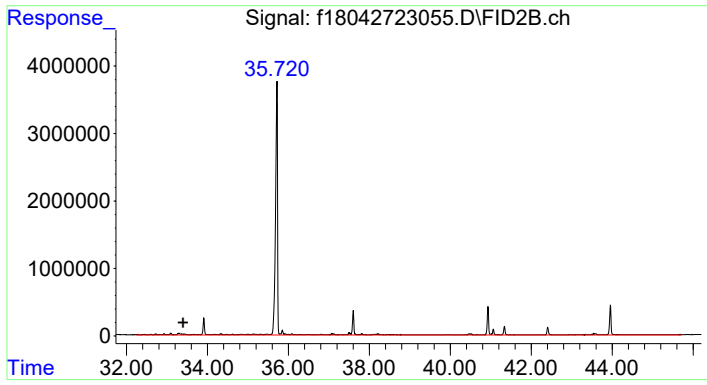

#8 > C21 to C32 Aliphatics

R.T.: 33.402 min  
Delta R.T.: 0.000 min  
Response: 85622710  
Conc: 68.64 UG/ML m

Data Path : C:\Projects\Hawaii DOH\2. Laboratory Data\Alpha\WAF Study\L2317027\TPH\NF TPH\  
 Data File : f18050823015.D  
 Signal(s) : FID2B.ch  
 Acq On : 08 May 2023 07:03 pm  
 Operator : FID18:AMV  
 Sample : L2317027-29F1  
 Misc : WG1776333,WG1771484,ICAL19877  
 ALS Vial : 58 Sample Multiplier: 1

Integration File: SHCINT2.E  
 Quant Time: May 29 22:36:45 2023  
 Quant Method : C:\Projects\Hawaii DOH\2. Laboratory Data\Alpha\WAF Study\L2317027\TPH\NF TPH\NF T  
 .. PH Quant.M  
 Quant Title : FID Forensics  
 QLast Update : Fri Sep 23 15:53:13 2022  
 Response via : Initial Calibration  
 Integrator: ChemStation

Volume Inj. : 1.0  
 Signal Phase : Rtx-5MS  
 Signal Info : 0.25mm

Blank Name : IB1805082301R  
 Blank File : f18050823009.D

Compound	R.T.	Response	Conc Units
-----			
Internal Standards			
1) I 5-alpha-androstane	30.945	69076350	50.000 ug/mL m
System Monitoring Compounds			
3) s d50-Tetracosane	35.606	124425374	108.972 ug/mL m
Spiked Amount 50.000	Range 50 - 130	Recovery	= 217.94%#
Target Compounds			
4) h > C8 to C10 Aliphatics	8.012	8081919	6.210 ug/mL m
5) h > C10 to C12 Aliphatics	12.930	5098397	3.918 ug/ml m
6) h > C12 to C16 Aliphatics	23.659	2589580	1.990 UG/ML m
7) h > C16 to C21 Aliphatics	28.995	2529078	1.943 UG/ML m
8) h > C21 to C32 Aliphatics	33.402	18535277	14.242 UG/ML m

SemiQuant Compounds - Not Calibrated on this Instrument

(f)=RT Delta > 1/2 Window

(m)=manual int.

Data Path : C:\Projects\Hawaii DOH\2. Laboratory Data\Alpha\WAF Study\L2317027\TPH\NF TPH\  
Data File : f18050823015.D  
Signal(s) : FID2B.ch  
Acq On : 08 May 2023 07:03 pm  
Operator : FID18:AMV  
Sample : L2317027-29F1  
Misc : WG1776333,WG1771484,ICAL19877  
ALS Vial : 58 Sample Multiplier: 1

Integration File: SHCINT2.E  
Quant Time: May 29 22:36:45 2023  
Quant Method : C:\Projects\Hawaii DOH\2. Laboratory Data\Alpha\WAF Study\L2317027\TPH\NF TPH\NF T  
... PH Quant.M  
Quant Title : FID Forensics  
QLast Update : Fri Sep 23 15:53:13 2022  
Response via : Initial Calibration  
Integrator: ChemStation

Volume Inj. : 1.0  
Signal Phase : Rtx-5MS  
Signal Info : 0.25mm

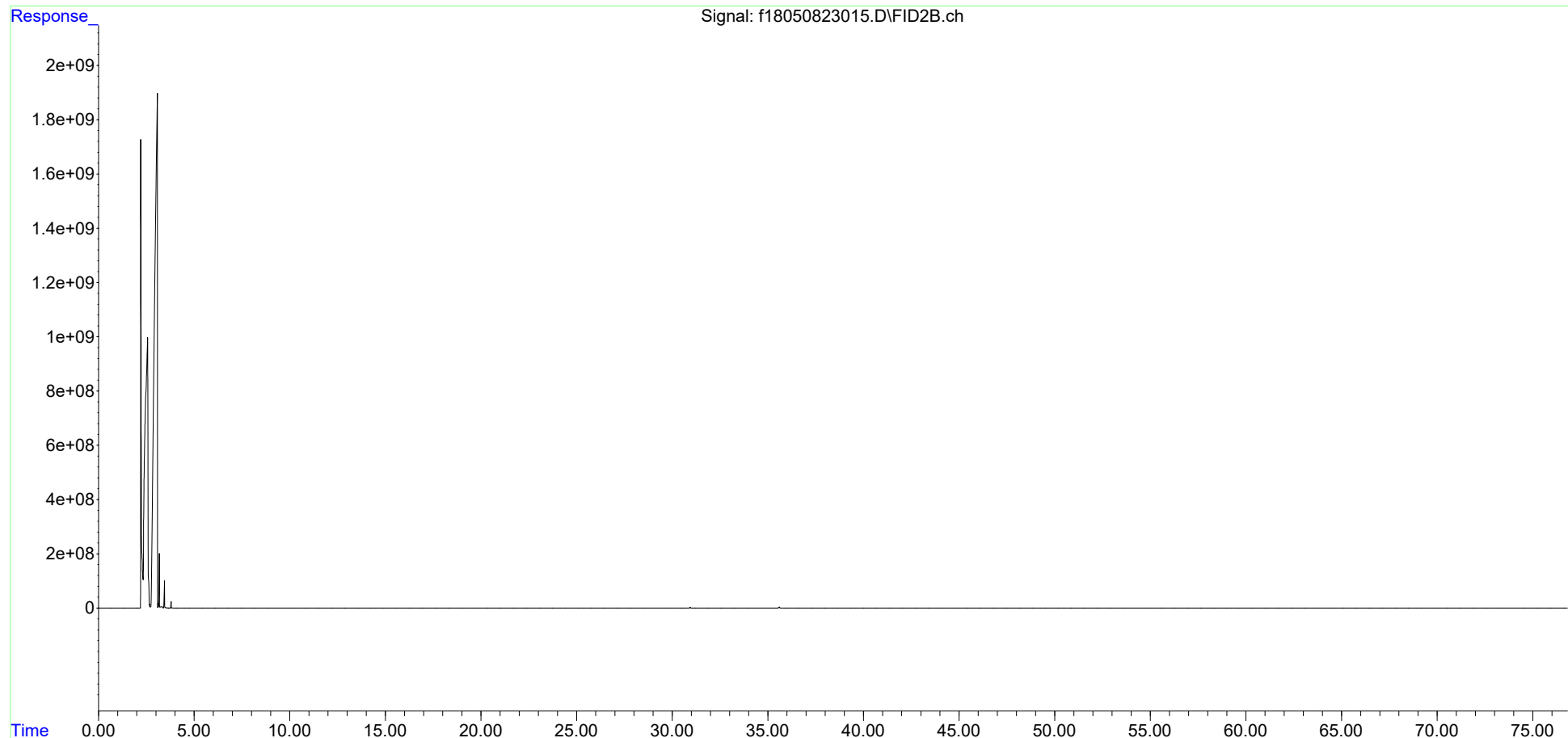

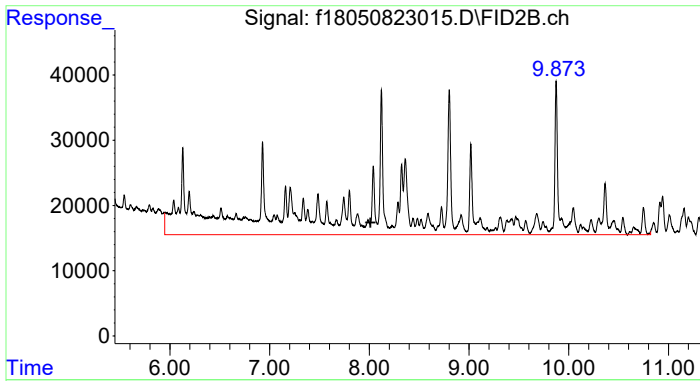

#4 > C8 to C10 Aliphatics

R.T.: 8.012 min  
 Delta R.T.: 0.000 min  
 Response: 8081919  
 Conc: 6.21 ug/mL m

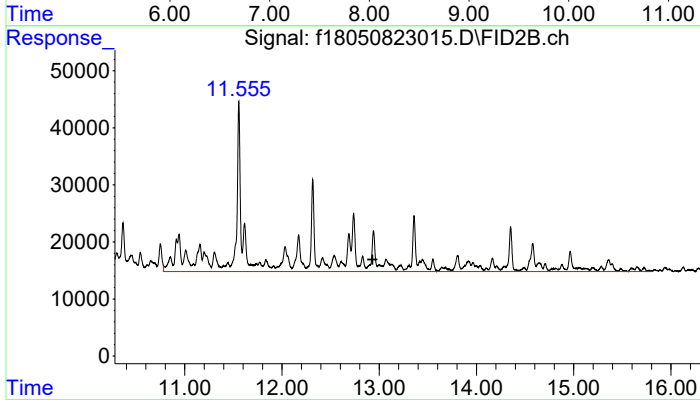

#5 > C10 to C12 Aliphatics

R.T.: 12.930 min  
 Delta R.T.: 0.000 min  
 Response: 5098397  
 Conc: 3.92 ug/ml m

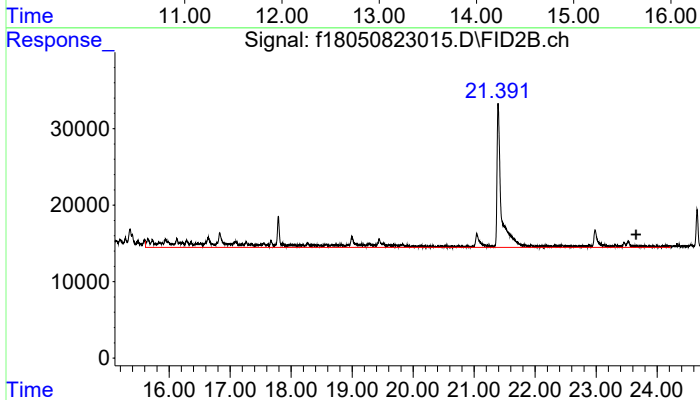

#6 > C12 to C16 Aliphatics

R.T.: 23.659 min  
 Delta R.T.: 0.000 min  
 Response: 2589580  
 Conc: 1.99 UG/ML m

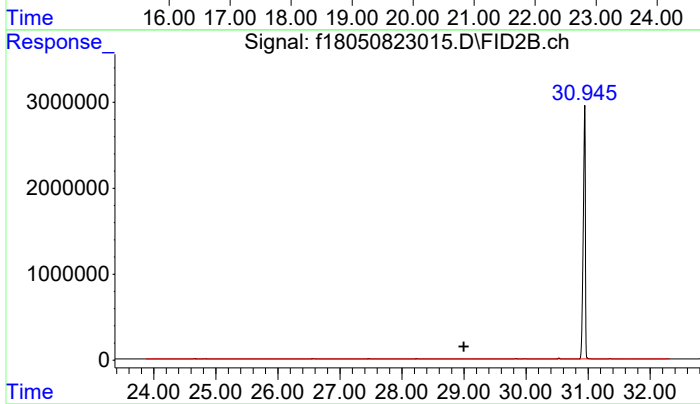

#7 > C16 to C21 Aliphatics

R.T.: 28.995 min  
 Delta R.T.: 0.000 min  
 Response: 2529078  
 Conc: 1.94 UG/ML m

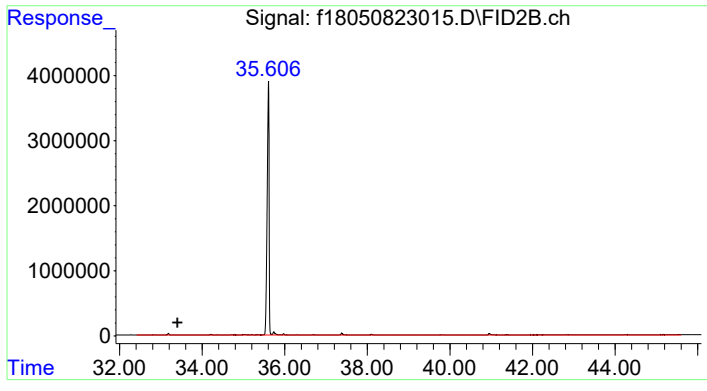

#8 > C21 to C32 Aliphatics

R.T.: 33.402 min  
Delta R.T.: 0.000 min  
Response: 18535277  
Conc: 14.24 UG/ML m



Data Path : C:\Projects\Hawaii DOH\2. Laboratory Data\Alpha\WAF Study\L2317027\TPH\NF TPH\  
 Data File : f18050823043.D  
 Signal(s) : FID2B.ch  
 Acq On : 09 May 2023 02:36 pm  
 Operator : FID18:AMV  
 Sample : L2317027-30F2  
 Misc : WG1776333,WG1771485,ICAL19877  
 ALS Vial : 72 Sample Multiplier: 1

Integration File: SHCINT2.E  
 Quant Time: Jun 01 10:59:39 2023  
 Quant Method : C:\Projects\Hawaii DOH\2. Laboratory Data\Alpha\WAF Study\L2317027\TPH\NF TPH\NF T  
 .. PH Quant.M  
 Quant Title : FID Forensics  
 QLast Update : Fri Sep 23 15:53:13 2022  
 Response via : Initial Calibration  
 Integrator: ChemStation

Volume Inj. : 1.0  
 Signal Phase : Rtx-5MS  
 Signal Info : 0.25mm

Blank Name : IB1805082302R  
 Blank File : f18050823039.D

Compound	R.T.	Response	Conc Units
-----			
Internal Standards			
1) I 5-alpha-androstane	30.938	61675086	50.000 ug/mL m
System Monitoring Compounds			
2) s ortho-terphenyl	28.963	139572906	108.251 ug/mL m
Spiked Amount 50.000	Range 50 - 130	Recovery	= 216.50%#
Target Compounds			
9) h > C8 to C10 Aromatics	7.704	419464558	360.993 UG/ML m
10) h > C10 to C12 Aromatics	12.274	796613994	685.569 UG/ML m
11) h > C12 to C16 Aromatics	17.385	504610155	434.269 UG/ML m
12) h > C16 to C21 Aromatics	28.995	12027138	10.351 UG/ML m
13) h > C21 to C32 Aromatics	34.889	23241293	20.002 UG/ML m

SemiQuant Compounds - Not Calibrated on this Instrument

(f)=RT Delta > 1/2 Window

(m)=manual int.

Data Path : C:\Projects\Hawaii DOH\2. Laboratory Data\Alpha\WAF Study\L2317027\TPH\NF TPH\  
Data File : f18050823043.D  
Signal(s) : FID2B.ch  
Acq On : 09 May 2023 02:36 pm  
Operator : FID18:AMV  
Sample : L2317027-30F2  
Misc : WG1776333,WG1771485,ICAL19877  
ALS Vial : 72 Sample Multiplier: 1

Integration File: SHCINT2.E  
Quant Time: Jun 01 10:59:39 2023  
Quant Method : C:\Projects\Hawaii DOH\2. Laboratory Data\Alpha\WAF Study\L2317027\TPH\NF TPH\NF T  
PH Quant.M  
Quant Title : FID Forensics  
QLast Update : Fri Sep 23 15:53:13 2022  
Response via : Initial Calibration  
Integrator: ChemStation

Volume Inj. : 1.0  
Signal Phase : Rtx-5MS  
Signal Info : 0.25mm

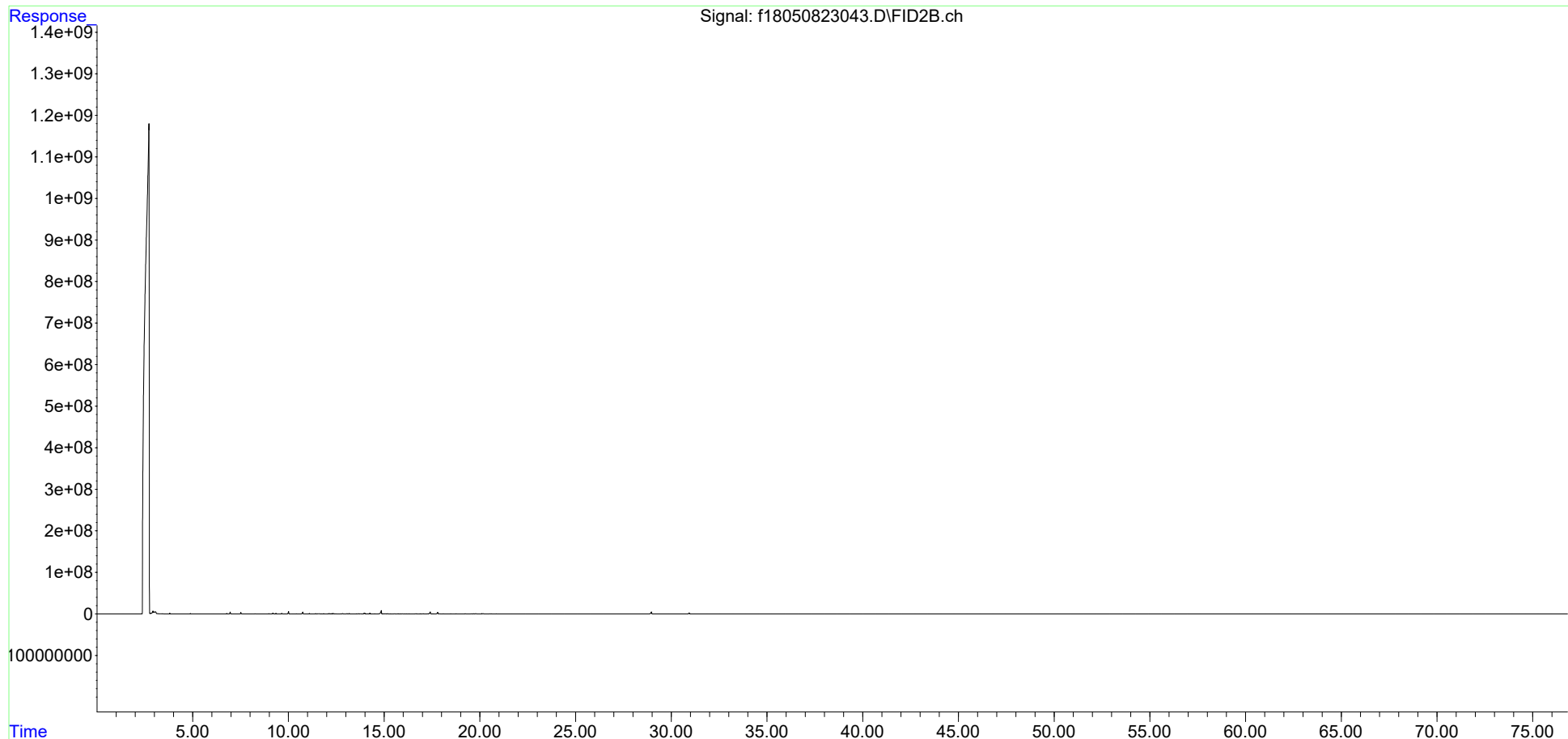

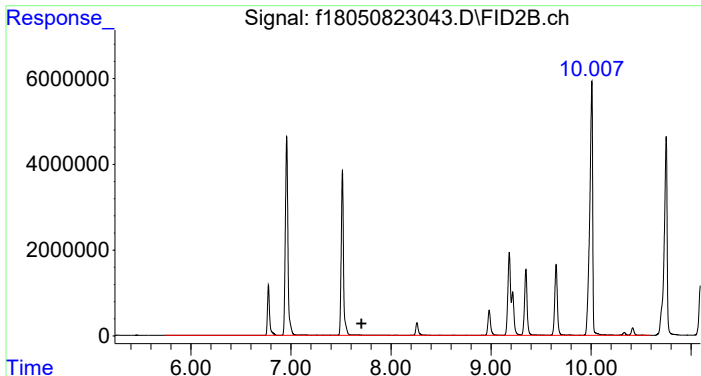

#9 > C8 to C10 Aromatics  
 R.T.: 7.704 min  
 Delta R.T.: 0.000 min  
 Response: 419464558  
 Conc: 360.99 UG/ML m

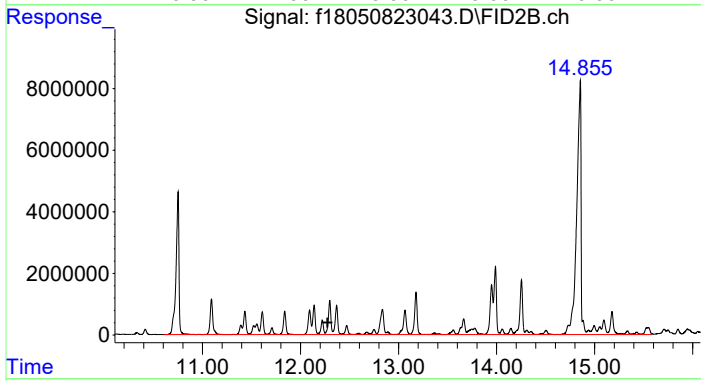

#10 > C10 to C12 Aromatics  
 R.T.: 12.274 min  
 Delta R.T.: 0.000 min  
 Response: 796613994  
 Conc: 685.57 UG/ML m

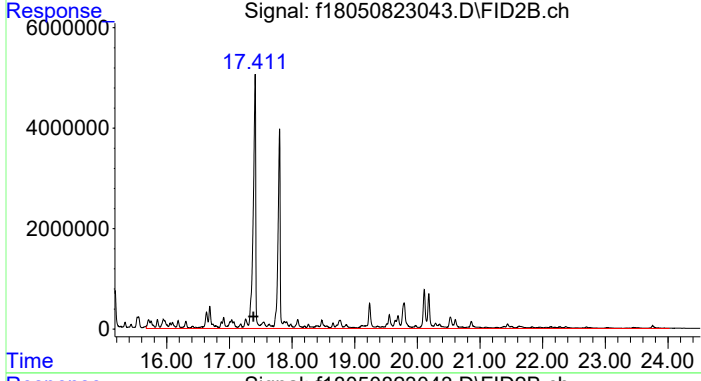

#11 > C12 to C16 Aromatics  
 R.T.: 17.385 min  
 Delta R.T.: 0.000 min  
 Response: 504610155  
 Conc: 434.27 UG/ML m

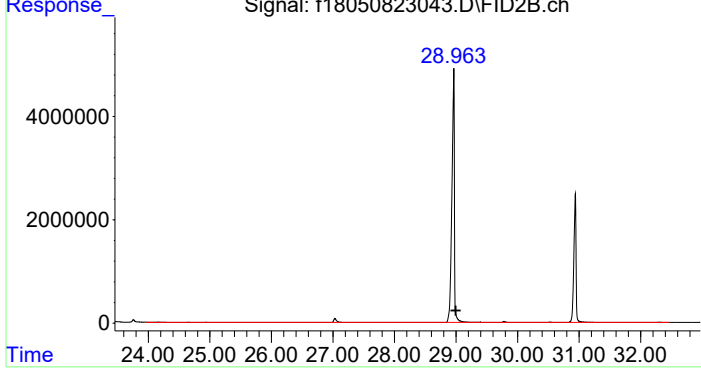

#12 > C16 to C21 Aromatics  
 R.T.: 28.995 min  
 Delta R.T.: 0.000 min  
 Response: 12027138  
 Conc: 10.35 UG/ML m

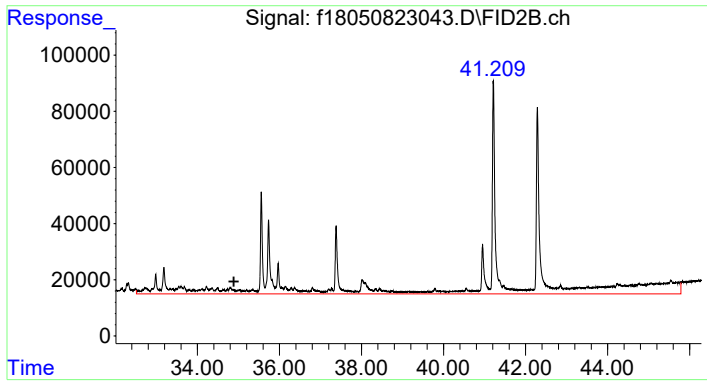

#13 > C21 to C32 Aromatics

R.T.: 34.889 min  
Delta R.T.: 0.000 min  
Response: 23241293  
Conc: 20.00 UG/ML m

Data Path : C:\Projects\Hawaii DOH\2. Laboratory Data\Alpha\WAF Study\L2317027\TPH\NF TPH\  
 Data File : f18042723039.D  
 Signal(s) : FID2B.ch  
 Acq On : 28 Apr 2023 12:23 pm  
 Operator : FID18:AMV  
 Sample : IB1804272302R  
 Misc :  
 ALS Vial : 70 Sample Multiplier: 1

Integration File: SHCINT2.E  
 Quant Time: May 31 16:48:17 2023  
 Quant Method : C:\Projects\Hawaii DOH\2. Laboratory Data\Alpha\WAF Study\L2317027\TPH\NF TPH\NF T  
 .. PH Quant.M  
 Quant Title : FID Forensics  
 QLast Update : Fri Sep 23 15:53:13 2022  
 Response via : Initial Calibration  
 Integrator: ChemStation

Volume Inj. : 1.0  
 Signal Phase : Rtx-5MS  
 Signal Info : 0.25mm

Blank Name : IB1804272301R  
 Blank File : f18042723009.D

Compound	R.T.	Response	Conc	Units
<b>Internal Standards</b>				
1) I 5-alpha-androstane	0.000	0	N.D.	ug/mL
<b>System Monitoring Compounds</b>				
2) s ortho-terphenyl	0.000	0	N.D.	ug/mL
Spiked Amount	50.000	Range	50 - 130	Recovery = 0.00%#
3) s d50-Tetracosane	0.000	0	N.D.	ug/mL
Spiked Amount	50.000	Range	50 - 130	Recovery = 0.00%#
<b>Target Compounds</b>				
4) h > C8 to C10 Aliphatics	8.012	4636049	N.D.	ug/mL m
5) h > C10 to C12 Aliphatics	12.930	2386879	N.D.	ug/mL m
6) h > C12 to C16 Aliphatics	23.659	1467152	N.D.	UG/ML m
7) h > C16 to C21 Aliphatics	28.995	3316219	N.D.	UG/ML m
8) h > C21 to C32 Aliphatics	33.402	14608554	N.D.	UG/ML m
9) h > C8 to C10 Aromatics	0.000	0	N.D.	UG/ML d
10) h > C10 to C12 Aromatics	0.000	0	N.D.	UG/ML d
11) h > C12 to C16 Aromatics	0.000	0	N.D.	UG/ML d
12) h > C16 to C21 Aromatics	0.000	0	N.D.	UG/ML d
13) h > C21 to C32 Aromatics	0.000	0	N.D.	UG/ML d

SemiQuant Compounds - Not Calibrated on this Instrument

(f)=RT Delta > 1/2 Window

(m)=manual int.

Data Path : C:\Projects\Hawaii DOH\2. Laboratory Data\Alpha\WAF Study\L2317027\TPH\NF TPH\  
 Data File : f18050523061.D  
 Signal(s) : FID2B.ch  
 Acq On : 07 May 2023 05:03 am  
 Operator : FID18:AMV  
 Sample : IB1805052303R  
 Misc :  
 ALS Vial : 81 Sample Multiplier: 1

Integration File: SHCINT2.E  
 Quant Time: May 29 21:40:46 2023  
 Quant Method : C:\Projects\Hawaii DOH\2. Laboratory Data\Alpha\WAF Study\L2317027\TPH\NF TPH\NF T  
 .. PH Quant.M  
 Quant Title : FID Forensics  
 QLast Update : Mon May 29 15:16:17 2023  
 Response via : Initial Calibration  
 Integrator: ChemStation

Volume Inj. : 1.0  
 Signal Phase : Rtx-5MS  
 Signal Info : 0.25mm

Blank Name : IB1805052302R  
 Blank File : f18050523031.D

Compound	R.T.	Response	Conc	Units
Internal Standards				
1) I 5-alpha-androstane	0.000	0	N.D.	ug/mL
System Monitoring Compounds				
2) s ortho-terphenyl	0.000	0	N.D.	ug/mL
Spiked Amount	50.000	Range	50 - 130	Recovery = 0.00%#
3) s d50-Tetracosane	0.000	0	N.D.	ug/mL
Spiked Amount	50.000	Range	50 - 130	Recovery = 0.00%#
Target Compounds				
4) h > C8 to C10 Aliphatics	8.012	2496176	N.D.	ug/mL m
5) h > C10 to C12 Aliphatics	12.930	696250	N.D.	ug/mL m
6) h > C12 to C16 Aliphatics	23.659	918700	N.D.	UG/ML m
7) h > C16 to C21 Aliphatics	28.995	1154105	N.D.	UG/ML m
8) h > C21 to C32 Aliphatics	33.402	11677041	N.D.	UG/ML m
9) h > C8 to C10 Aromatics	0.000	0	N.D.	UG/ML d
10) h > C10 to C12 Aromatics	0.000	0	N.D.	UG/ML d
11) h > C12 to C16 Aromatics	0.000	0	N.D.	UG/ML d
12) h > C16 to C21 Aromatics	0.000	0	N.D.	UG/ML d
13) h > C21 to C32 Aromatics	0.000	0	N.D.	UG/ML d

SemiQuant Compounds - Not Calibrated on this Instrument

(f)=RT Delta > 1/2 Window

(m)=manual int.

Data Path : C:\Projects\Hawaii DOH\2. Laboratory Data\Alpha\WAF Study\L2317027\TPH\NF TPH\  
 Data File : f18050823009.D  
 Signal(s) : FID2B.ch  
 Acq On : 08 May 2023 02:51 pm  
 Operator : FID18:AMV  
 Sample : IB1805082301R  
 Misc :  
 ALS Vial : 55 Sample Multiplier: 1

Integration File: SHCINT2.E  
 Quant Time: May 29 22:27:49 2023  
 Quant Method : C:\Projects\Hawaii DOH\2. Laboratory Data\Alpha\WAF Study\L2317027\TPH\NF TPH\NF T  
 .. PH Quant.M  
 Quant Title : FID Forensics  
 QLast Update : Fri Sep 23 15:53:13 2022  
 Response via : Initial Calibration  
 Integrator: ChemStation

Volume Inj. : 1.0  
 Signal Phase : Rtx-5MS  
 Signal Info : 0.25mm

Compound	R.T.	Response	Conc	Units
Internal Standards				
1) I 5-alpha-androstane	0.000	0	N.D.	ug/mL
System Monitoring Compounds				
2) s ortho-terphenyl	0.000	0	N.D.	ug/mL
Spiked Amount 50.000	Range 50 - 130	Recovery	=	0.00%#
3) s d50-Tetracosane	0.000	0	N.D.	ug/mL
Spiked Amount 50.000	Range 50 - 130	Recovery	=	0.00%#
Target Compounds				
4) h > C8 to C10 Aliphatics	8.012	1330844	N.D.	ug/mL m
5) h > C10 to C12 Aliphatics	12.930	767773	N.D.	ug/ml m
6) h > C12 to C16 Aliphatics	23.659	812679	N.D.	UG/ML m
7) h > C16 to C21 Aliphatics	28.995	1029837	N.D.	UG/ML m
8) h > C21 to C32 Aliphatics	33.402	14622711	N.D.	UG/ML m
9) h > C8 to C10 Aromatics	7.704	1238591	N.D.	UG/ML m
10) h > C10 to C12 Aromatics	0.000	0	N.D.	UG/ML d
11) h > C12 to C16 Aromatics	0.000	0	N.D.	UG/ML d
12) h > C16 to C21 Aromatics	0.000	0	N.D.	UG/ML d
13) h > C21 to C32 Aromatics	0.000	0	N.D.	UG/ML d

SemiQuant Compounds - Not Calibrated on this Instrument

(f)=RT Delta > 1/2 Window

(m)=manual int.

Data Path : C:\Projects\Hawaii DOH\2. Laboratory Data\Alpha\WAF Study\L2317027\TPH\NF TPH\  
 Data File : f18050823039.D  
 Signal(s) : FID2B.ch  
 Acq On : 09 May 2023 11:49 am  
 Operator : FID18:AMV  
 Sample : IB1805082302R  
 Misc :  
 ALS Vial : 70 Sample Multiplier: 1

Integration File: SHCINT2.E  
 Quant Time: May 30 14:18:34 2023  
 Quant Method : C:\Projects\Hawaii DOH\2. Laboratory Data\Alpha\WAF Study\L2317027\TPH\NF TPH\NF T  
 .. PH Quant.M  
 Quant Title : FID Forensics  
 QLast Update : Fri Sep 23 15:53:13 2022  
 Response via : Initial Calibration  
 Integrator: ChemStation

Volume Inj. : 1.0  
 Signal Phase : Rtx-5MS  
 Signal Info : 0.25mm

Blank Name : IB1805082301R  
 Blank File : f18050823009.D

Compound	R.T.	Response	Conc	Units
<b>Internal Standards</b>				
1) I 5-alpha-androstane	0.000	0	N.D.	ug/mL
<b>System Monitoring Compounds</b>				
2) s ortho-terphenyl	0.000	0	N.D.	ug/mL
Spiked Amount	50.000	Range	50 - 130	Recovery = 0.00%#
3) s d50-Tetracosane	0.000	0	N.D.	ug/mL
Spiked Amount	50.000	Range	50 - 130	Recovery = 0.00%#
<b>Target Compounds</b>				
4) h > C8 to C10 Aliphatics	8.012	1946956	N.D.	ug/mL m
5) h > C10 to C12 Aliphatics	12.930	796267	N.D.	ug/mL m
6) h > C12 to C16 Aliphatics	23.659	932192	N.D.	UG/ML m
7) h > C16 to C21 Aliphatics	28.995	1259571	N.D.	UG/ML m
8) h > C21 to C32 Aliphatics	33.402	11110953	N.D.	UG/ML m
9) h > C8 to C10 Aromatics	0.000	0	N.D.	UG/ML d
10) h > C10 to C12 Aromatics	0.000	0	N.D.	UG/ML d
11) h > C12 to C16 Aromatics	0.000	0	N.D.	UG/ML d
12) h > C16 to C21 Aromatics	0.000	0	N.D.	UG/ML d
13) h > C21 to C32 Aromatics	0.000	0	N.D.	UG/ML d

SemiQuant Compounds - Not Calibrated on this Instrument

(f)=RT Delta > 1/2 Window

(m)=manual int.



# EPA Method TO-15: Detailed Quant Reports Aliphatic and Aromatic Carbon Ranges

Data Path : C:\Projects\Hawaii DOH\2. Laboratory Data\Alpha\WAF Study\L2259785 (JP5)\TO15-LL\NF T  
 ... O-15\  
 Data File : r426775.D  
 Acq On : 27 Feb 2023 4:14 AM  
 Operator : AIRPIANO4:TJS  
 Sample : L2259785-04D,3,0.98,250  
 Misc : WG1748790,ICAL19759  
 ALS Vial : 0 Sample Multiplier: 1

Quant Time: Jun 06 13:41:59 2023

Quant Method : C:\Projects\Hawaii DOH\2. Laboratory Data\Alpha\WAF Study\L2259785 (JP5)\TO15-LL\N  
 ... F TO-15\TFS4 230222 NF.M

Quant Title : TO-14A/TO-15 SIM/Full Scan Analysis

QLast Update : Mon Jun 05 12:01:55 2023

Response via : Initial Calibration

Compound	R.T.	QIon	Response	Conc	Units	Dev (Min)	
-----							
Internal Standards							
1) bromochloromethane	9.158	49	248810	10.00	ppbV	0.03	
4) 1,4-difluorobenzene	11.367	114	889778	10.00	ppbV	0.03	
11) chlorobenzene-D5	16.067	54	132204	10.00	ppbV	0.03	
Target Compounds							
							Qvalue
2) pentane	6.340	43	378322	15.73	ppbV		99
3) C5 - < C6 Aliphatics	6.340	TIC	4991728m	207.50	ppbV		
5) hexane	9.225	57	394391	12.92	ppbV #		11
6) C6 - < C7 Aliphatics	11.367	TIC	13543078m	443.61	ppbV		
7) benzene	10.953	78	189922	3.90	ppbV		97
8) C1 - Benzenes	10.953	78	189922	3.90	ppbV		97
9) heptane	12.527	43	661364	21.34	ppbV		97
10) C7 - C8 Aliphatics	15.333	TIC	49091659m	1583.91	ppbV		
12) toluene	14.308	91	1984125	31.80	ppbV		99
13) octane	15.333	85	1108010	46.00	ppbV		97
14) ethylbenzene	16.458	91	1403429	19.20	ppbV		99
15) m+p-xylene	16.608	91	3800341	64.52	ppbV		91
16) o-xylene	17.042	91	1949262m	33.63	ppbV		
17) C2-Benzenes	16.608	91	7168794m	123.69	ppbV		
18) nonane	17.233	43	3354625	74.22	ppbV		91
19) C9 - < C10 Aliphatics	17.233	TIC	147332226m	3259.81	ppbV		
20) 1,3,5-trimethylbenzene	18.175	105	1056933	15.42	ppbV		99
21) 1,2,4-Trimethylbenzene	18.525	105	2771183	42.11	ppbV #		54
22) C3-Benzenes	18.525	105	9806908m	149.01	ppbV		
23) decane	18.600	57	4671155	70.15	ppbV #		88
24) C10 - < C11 Aliphatics	18.600	TIC	117891520m	1770.40	ppbV		
25) undecane	19.675	57	3788325	53.42	ppbV		94
26) C11 - < C12 Aliphatics	19.667	TIC	70436189m	993.18	ppbV		
27) 1,2,4,5-tetramethylben...	19.908	119	222112	2.62	ppbV #		91
28) C4-Benzenes	19.233	134	2363149m	27.89	ppbV		
29) C5-Benzenes	19.733	148	656326m	7.74	ppbV		
30) dodecane	20.592	57	1120887	17.25	ppbV		95
31) C12 + Aliphatics	20.592	TIC	33943968m	522.50	ppbV		
-----							

(#) = qualifier out of range (m) = manual integration (+) = signals summed

Data Path : C:\Projects\Hawaii DOH\2. Laboratory Data\Alpha\WAF Study\L2259785 (JP5)\TO15-LL\NF T  
 ... O-15\  
 Data File : r426775.D  
 Acq On : 27 Feb 2023 4:14 AM  
 Operator : AIRPIANO4:TJS  
 Sample : L2259785-04D,3,0.98,250  
 Misc : WG1748790,ICAL19759  
 ALS Vial : 0 Sample Multiplier: 1

Quant Time: Jun 06 13:41:59 2023  
 Quant Method : C:\Projects\Hawaii DOH\2. Laboratory Data\Alpha\WAF Study\L2259785 (JP5)\TO15-LL\N  
 ... F TO-15\TFS4 230222 NF.M  
 Quant Title : TO-14A/TO-15 SIM/Full Scan Analysis  
 QLast Update : Mon Jun 05 12:01:55 2023  
 Response via : Initial Calibration

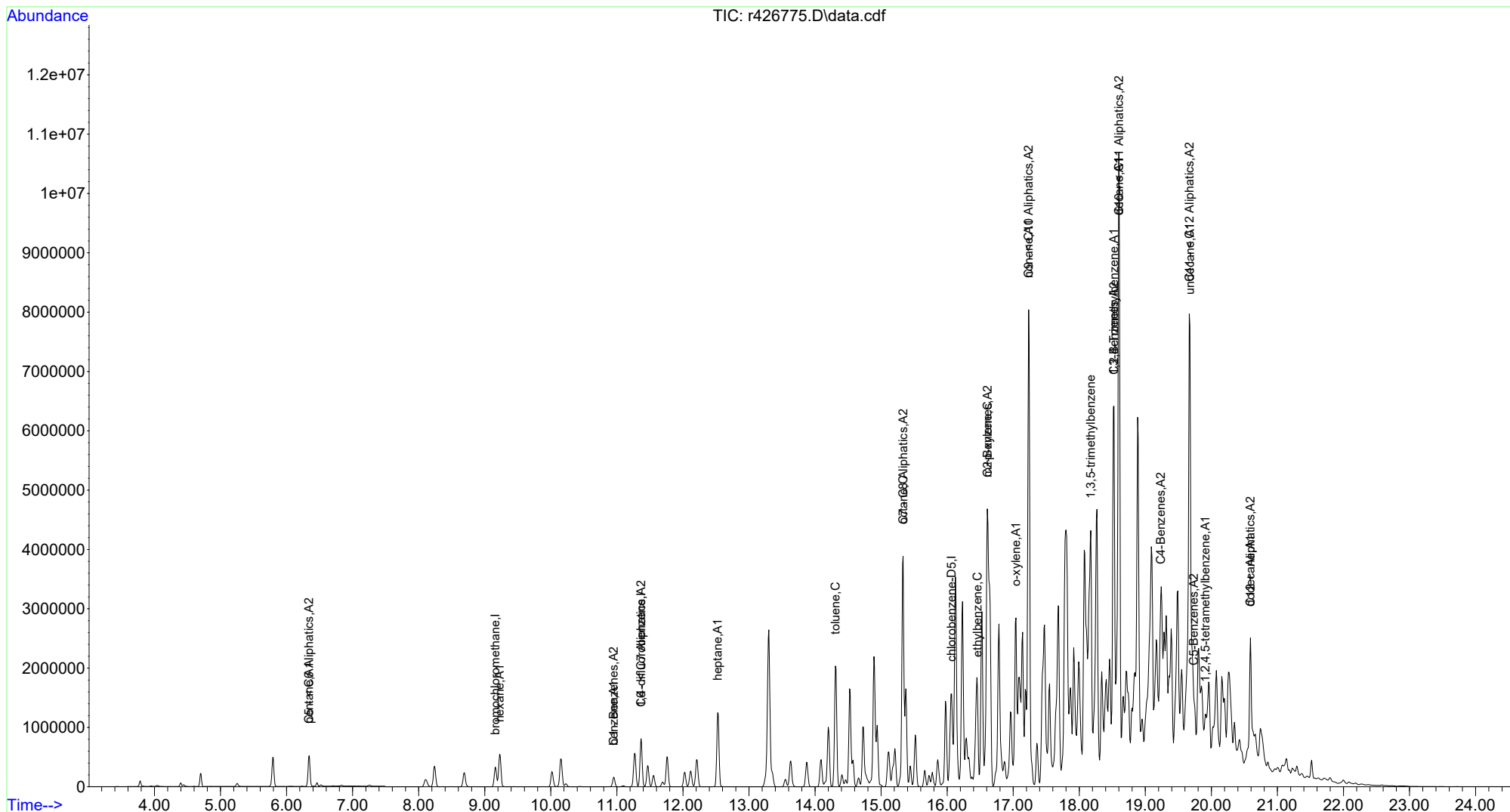

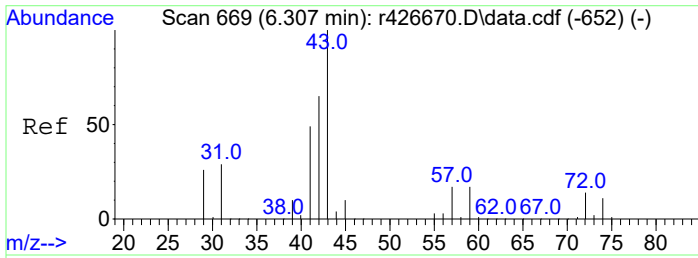

#2  
 pentane  
 Concen: 15.73 ppbV  
 RT: 6.340 min Scan# 679  
 Delta R.T. 0.033 min  
 Lab File: r426775.D  
 Acq: 27 Feb 2023 4:14 AM

Tgt Ion	Resp	Lower	Upper
43	100		
57	16.3	13.4	20.0
72	13.4	11.0	16.4

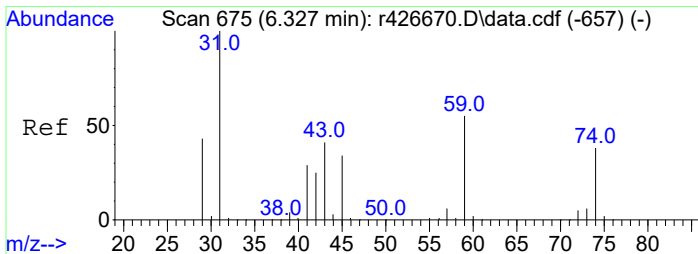
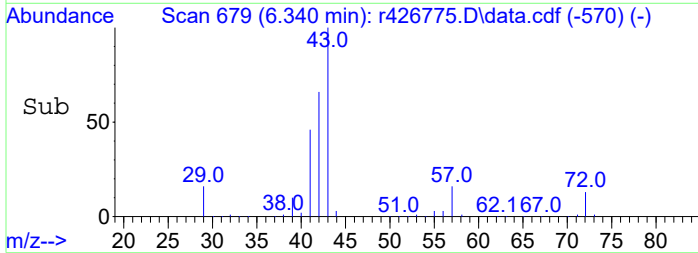
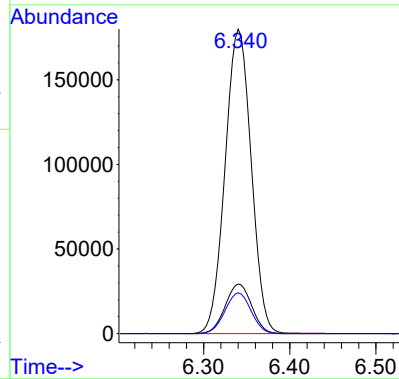
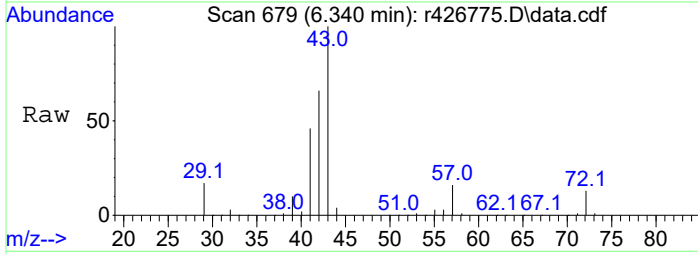

#3  
 C5 - < C6 Aliphatics  
 Concen: 207.50 ppbV m  
 RT: 6.340 min Scan# 679  
 Delta R.T. 0.000 min  
 Lab File: r426775.D  
 Acq: 27 Feb 2023 4:14 AM

Tgt Ion	Resp	Lower	Upper
TIC	100		
59	0.0	0.0	0.0
45	0.0	0.0	0.0

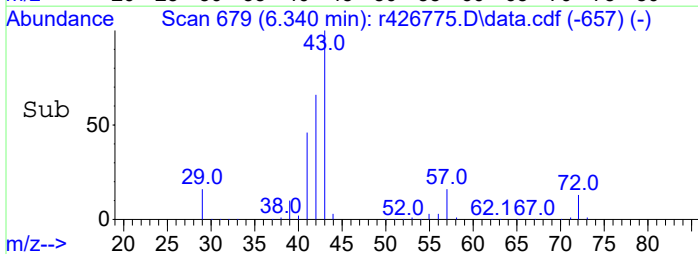
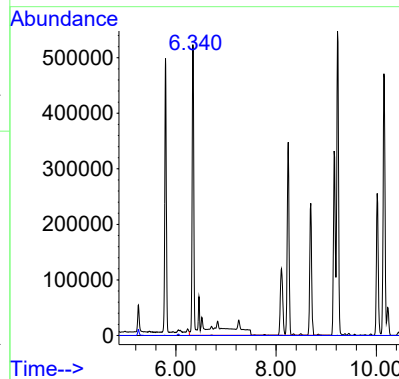
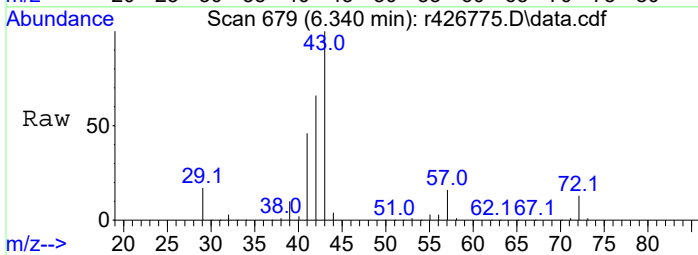

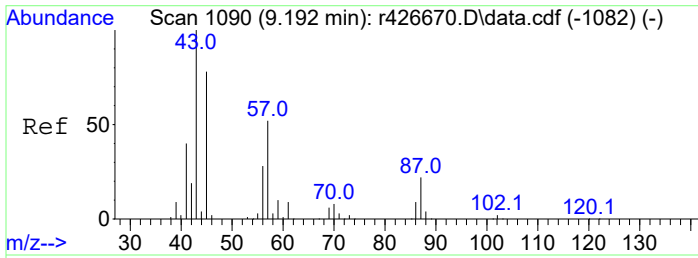

#5  
hexane  
Concen: 12.92 ppbV  
RT: 9.225 min Scan# 1094  
Delta R.T. 0.033 min  
Lab File: r426775.D  
Acq: 27 Feb 2023 4:14 AM

Tgt Ion: 57 Resp: 394391  
Ion Ratio Lower Upper  
57 100  
43 49.1 154.3 231.5#  
86 17.1 14.1 21.1

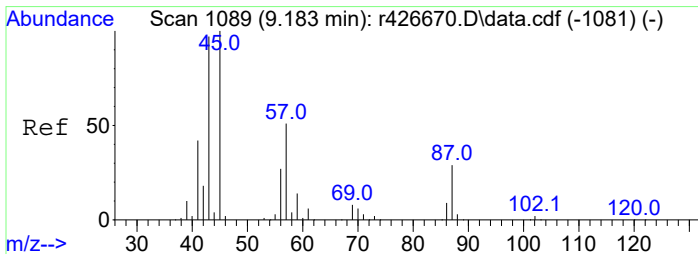
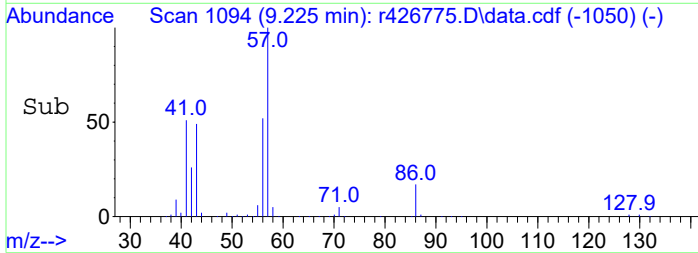
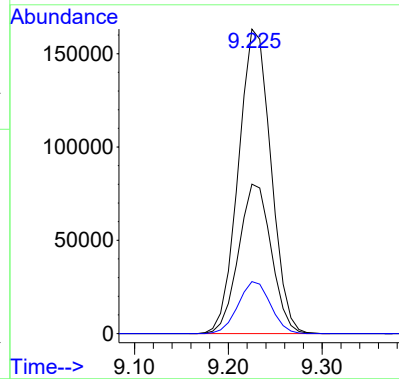
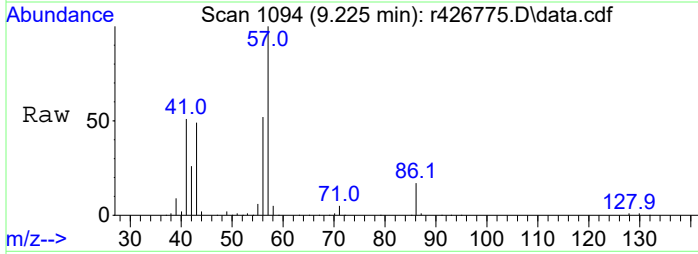

#6  
C6 - < C7 Aliphatics  
Concen: 443.61 ppbV m  
RT: 11.367 min Scan# 1372  
Delta R.T. -0.000 min  
Lab File: r426775.D  
Acq: 27 Feb 2023 4:14 AM

Tgt Ion:TIC Resp:13543078  
Ion Ratio Lower Upper  
TIC 100  
59 0.0 0.0 0.0  
45 86500.0 8.6 12.8#

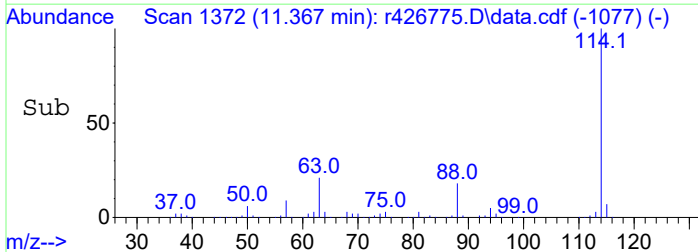
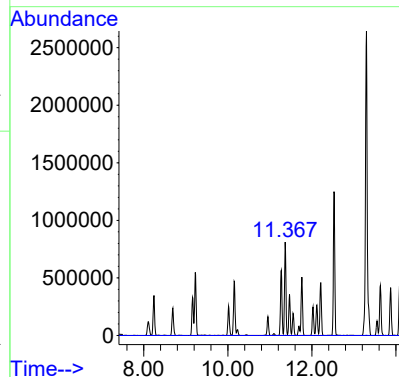
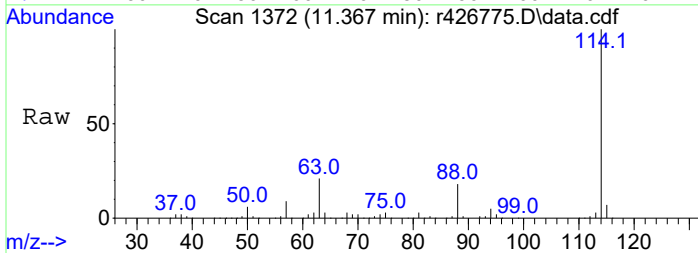

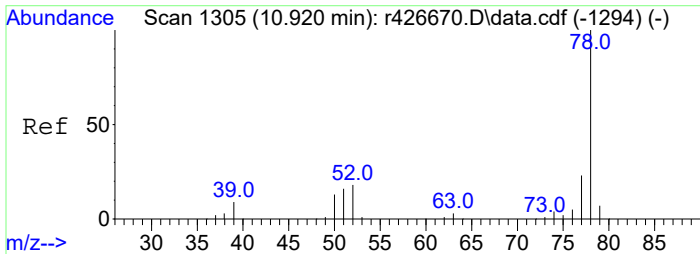

#7  
benzene  
Concen: 3.90 ppbV  
RT: 10.953 min Scan# 1310  
Delta R.T. 0.033 min  
Lab File: r426775.D  
Acq: 27 Feb 2023 4:14 AM

Tgt Ion	Resp	Lower	Upper
78	100		
52	16.7	14.2	21.4

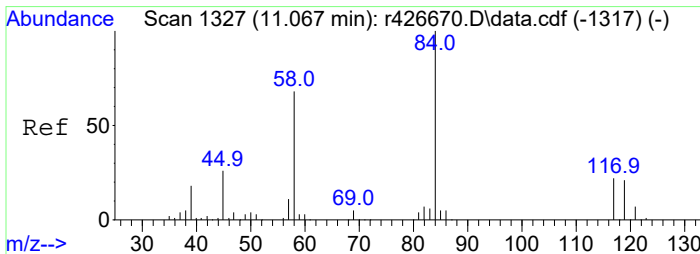
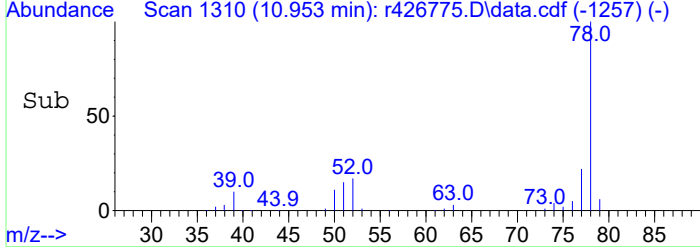
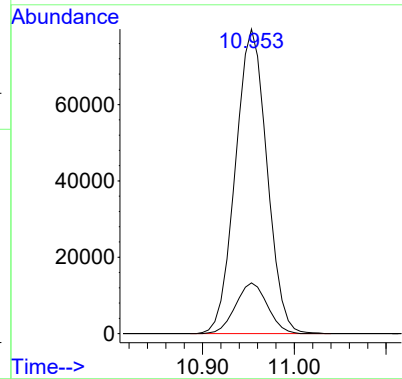
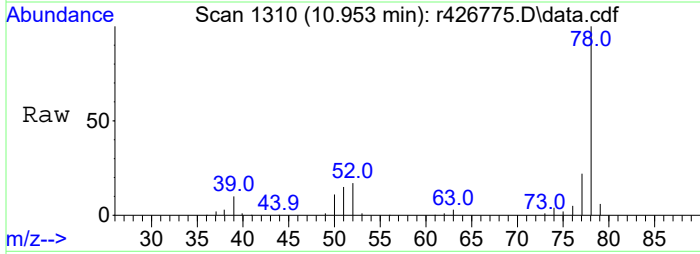

#8  
C1 - Benzenes  
Concen: 3.90 ppbV  
RT: 10.953 min Scan# 1310  
Delta R.T. -0.114 min  
Lab File: r426775.D  
Acq: 27 Feb 2023 4:14 AM

Tgt Ion	Resp	Lower	Upper
78	100		
52	16.7	14.2	21.4

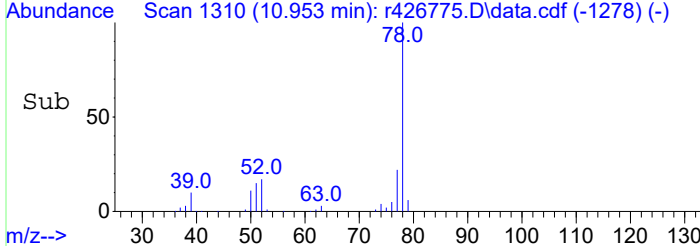
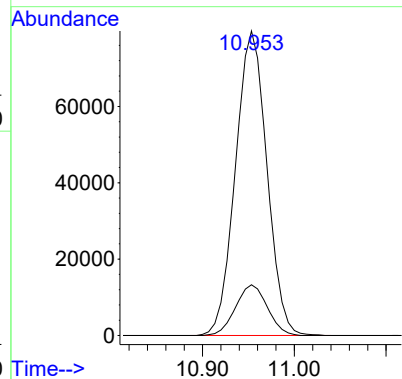
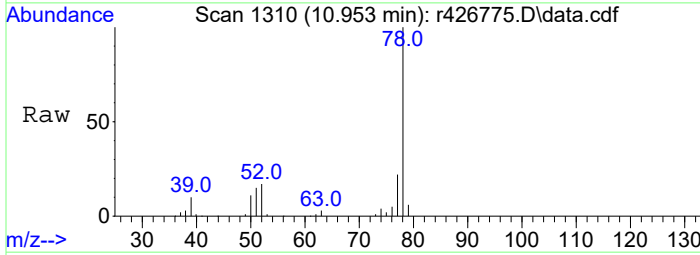

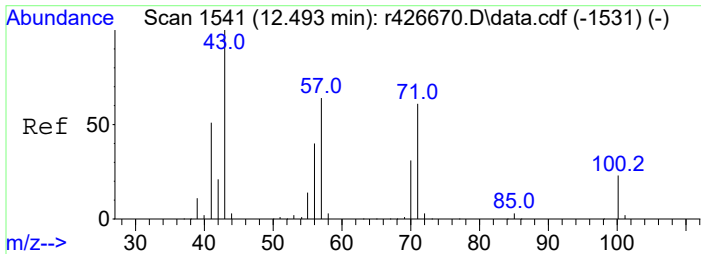

#9  
 heptane  
 Concen: 21.34 ppbV  
 RT: 12.527 min Scan# 1546  
 Delta R.T. 0.034 min  
 Lab File: r426775.D  
 Acq: 27 Feb 2023 4:14 AM

Tgt Ion	Resp	Lower	Upper
43	100		
57	65.9	51.1	76.7
100	24.8	18.2	27.4

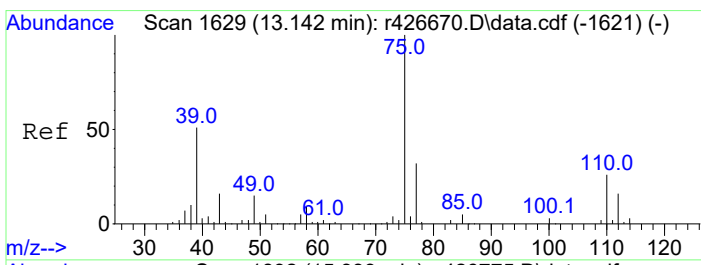
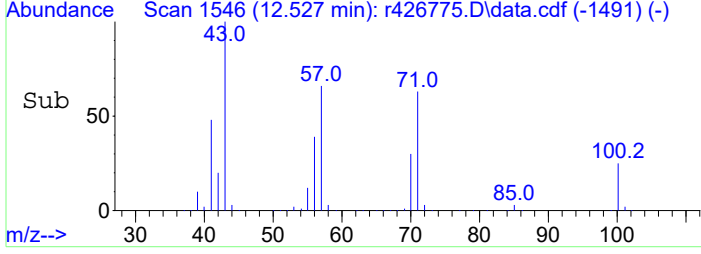
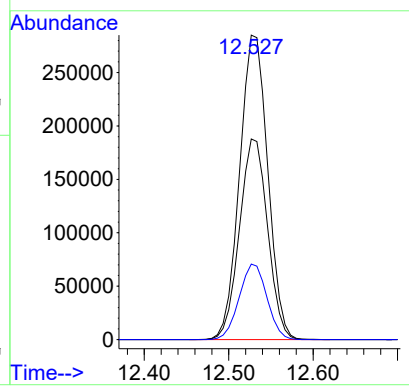
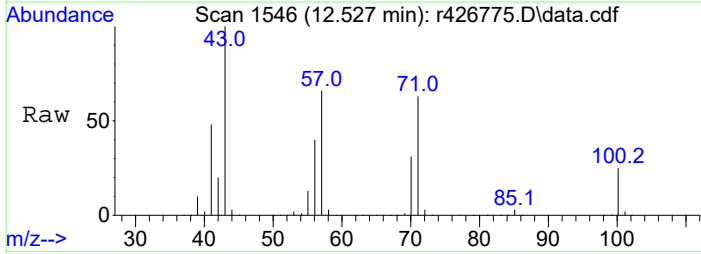

#10  
 C7 - C8 Aliphatics  
 Concen: 1583.91 ppbV m  
 RT: 15.333 min Scan# 1892  
 Delta R.T. 0.000 min  
 Lab File: r426775.D  
 Acq: 27 Feb 2023 4:14 AM

Tgt Ion	Resp	Lower	Upper
TIC	100		
39	7105500.0	146.3	219.5#
77	72000.0	1.5	2.3#

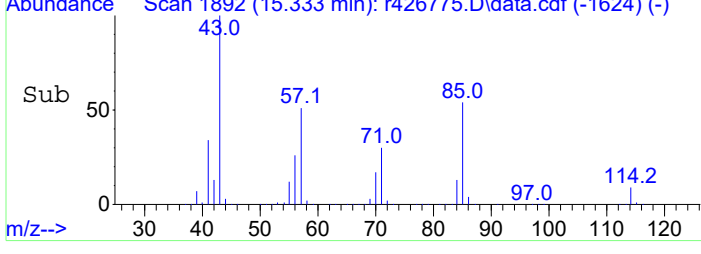
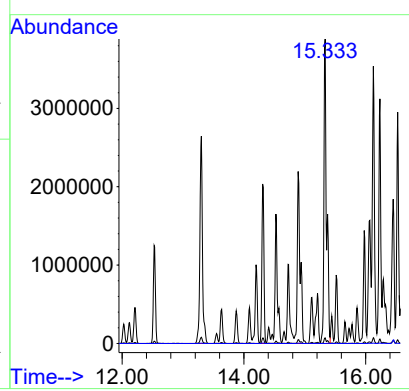
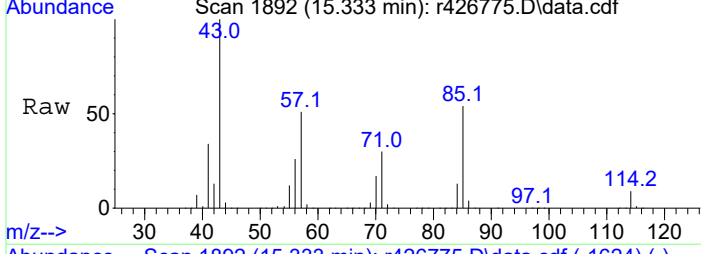

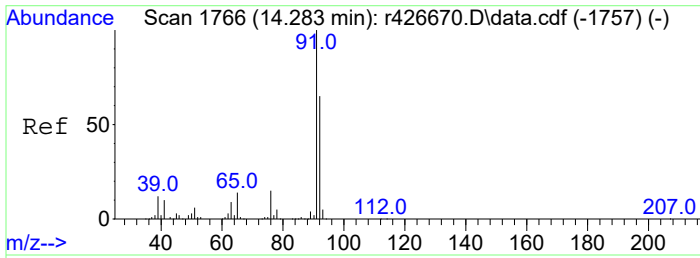

#12  
toluene  
Concen: 31.80 ppbV  
RT: 14.308 min Scan# 1769  
Delta R.T. 0.025 min  
Lab File: r426775.D  
Acq: 27 Feb 2023 4:14 AM

Tgt Ion: 91 Resp: 1984125  
Ion Ratio Lower Upper  
91 100  
92 66.0 52.2 78.2

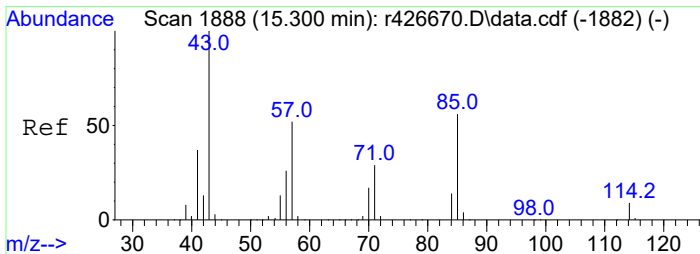
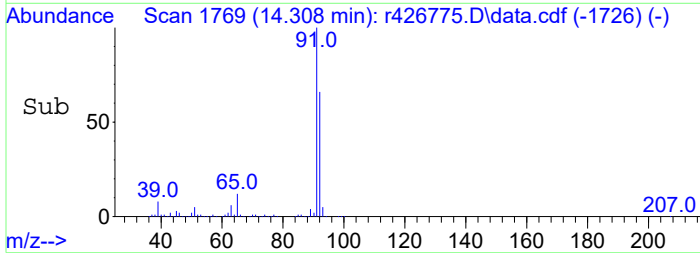
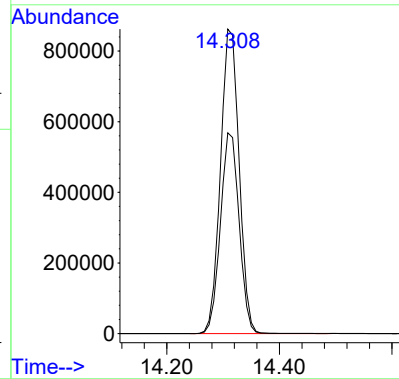
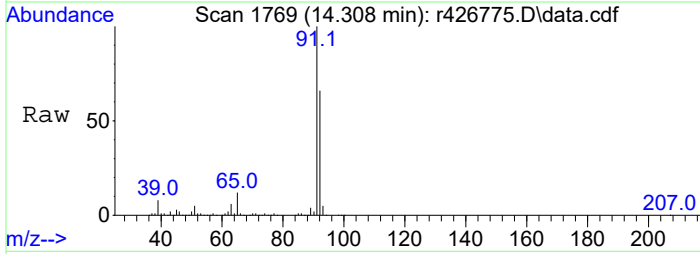

#13  
octane  
Concen: 46.00 ppbV  
RT: 15.333 min Scan# 1892  
Delta R.T. 0.033 min  
Lab File: r426775.D  
Acq: 27 Feb 2023 4:14 AM

Tgt Ion: 85 Resp: 1108010  
Ion Ratio Lower Upper  
85 100  
57 94.3 74.0 111.0  
114 16.1 12.2 18.4  
43 185.9 144.2 216.2

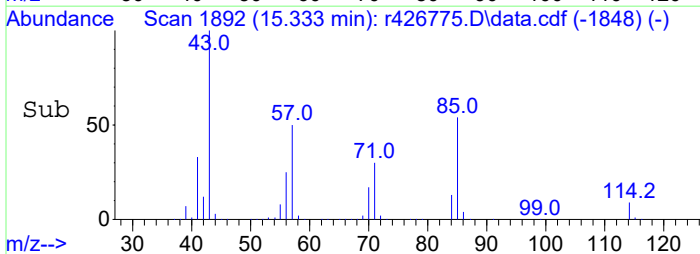
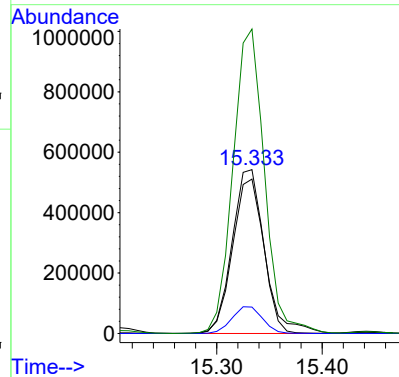
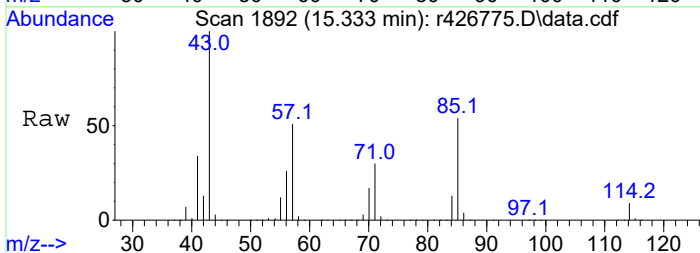



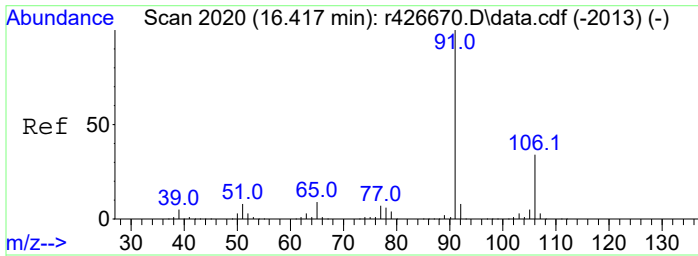

#14  
ethylbenzene  
Concen: 19.20 ppbV  
RT: 16.458 min Scan# 2025  
Delta R.T. 0.041 min  
Lab File: r426775.D  
Acq: 27 Feb 2023 4:14 AM

Tgt Ion: 91 Resp: 1403429  
Ion Ratio Lower Upper  
91 100  
106 34.8 27.5 41.3

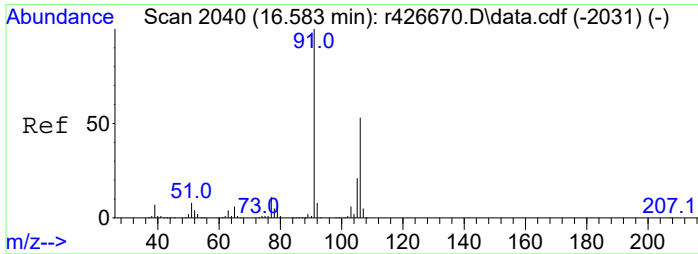
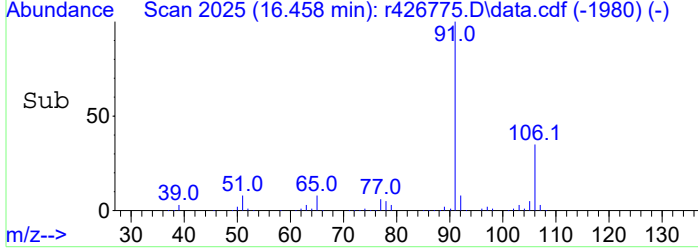
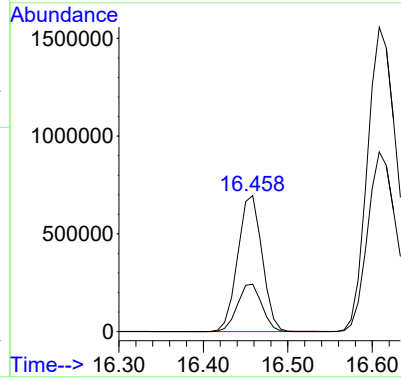
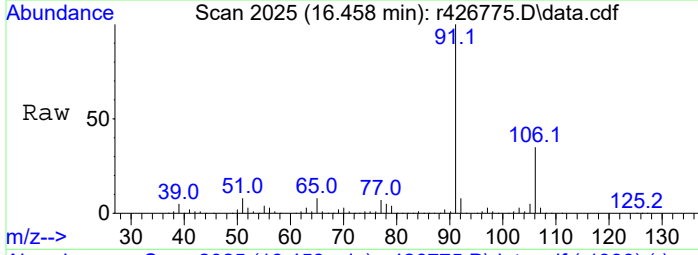

#15  
m+p-xylene  
Concen: 64.52 ppbV  
RT: 16.608 min Scan# 2043  
Delta R.T. 0.025 min  
Lab File: r426775.D  
Acq: 27 Feb 2023 4:14 AM

Tgt Ion: 91 Resp: 3800341  
Ion Ratio Lower Upper  
91 100  
106 59.0 42.1 63.1

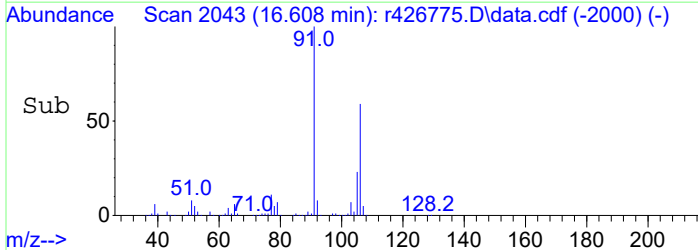
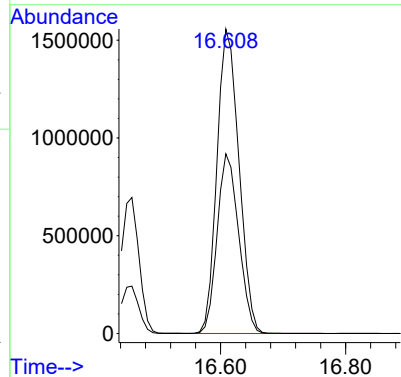
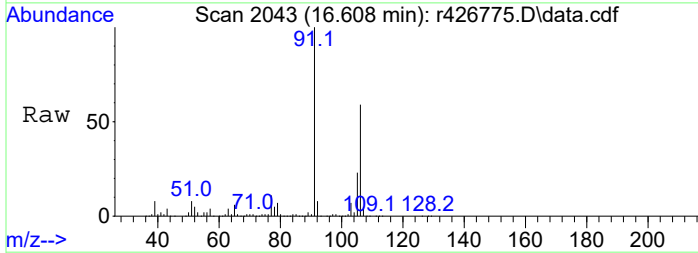

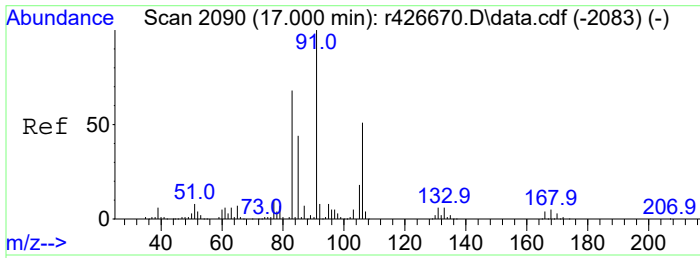

#16  
 o-xylene  
 Concen: 33.63 ppbV m  
 RT: 17.042 min Scan# 2095  
 Delta R.T. 0.434 min  
 Lab File: r426775.D  
 Acq: 27 Feb 2023 4:14 AM

Tgt Ion: 91 Resp: 1949262  
 Ion Ratio Lower Upper  
 91 100  
 106 53.4 47.2 70.8

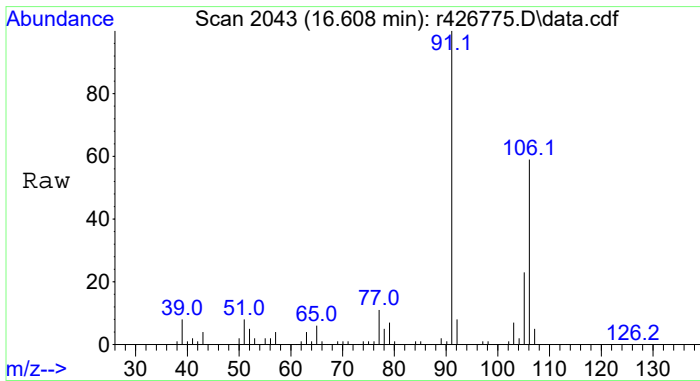
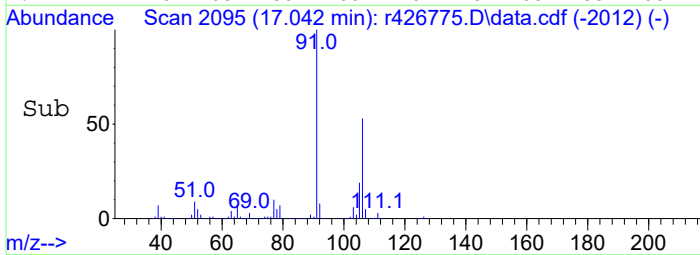
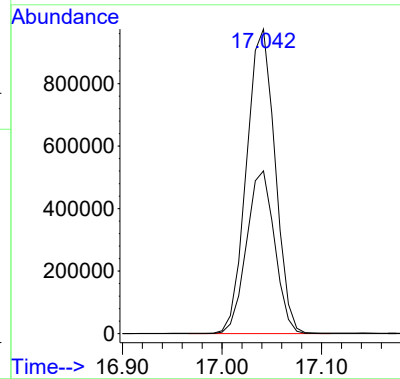
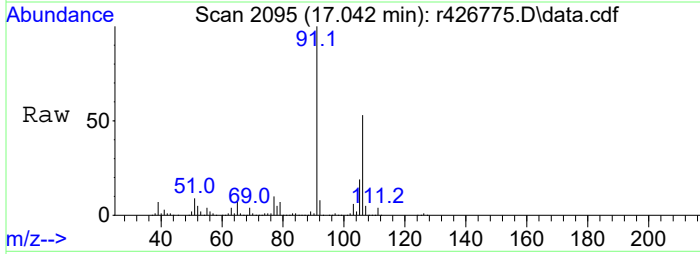

#17  
 C2-Benzenes  
 Concen: 123.69 ppbV m  
 RT: 16.608 min Scan# 2043  
 Delta R.T. 0.000 min  
 Lab File: r426775.D  
 Acq: 27 Feb 2023 4:14 AM

Tgt Ion: 91 Resp: 7168794  
 Ion Ratio Lower Upper  
 91 100  
 106 59.0 2660.0 3990.0#

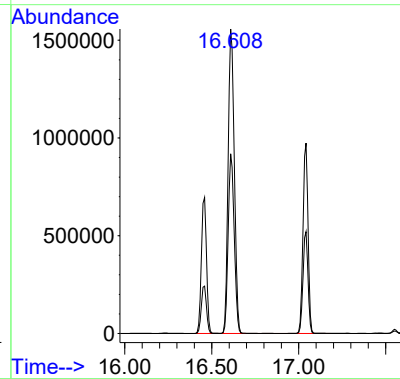
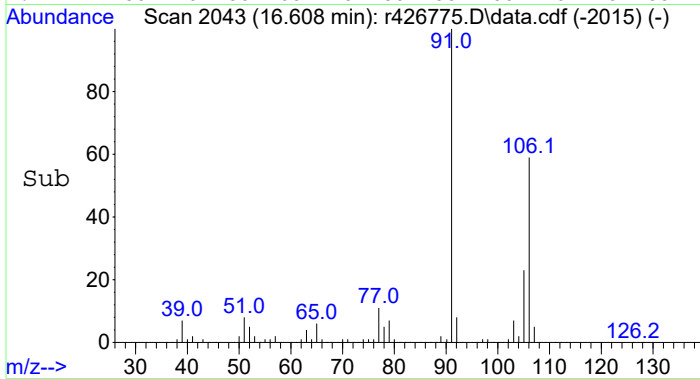

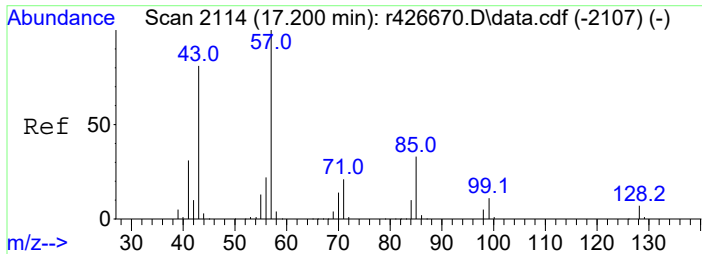

#18  
 nonane  
 Concen: 74.22 ppbV  
 RT: 17.233 min Scan# 2118  
 Delta R.T. 0.033 min  
 Lab File: r426775.D  
 Acq: 27 Feb 2023 4:14 AM

Tgt Ion:	Resp:	Lower	Upper
43	100		
57	112.4	98.4	147.6
128	8.7	6.6	10.0

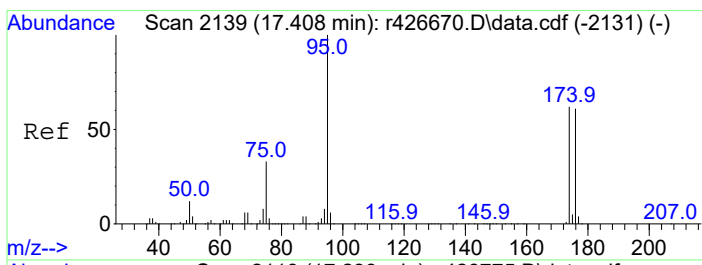
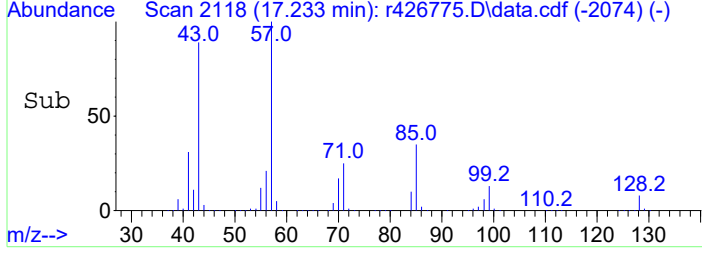
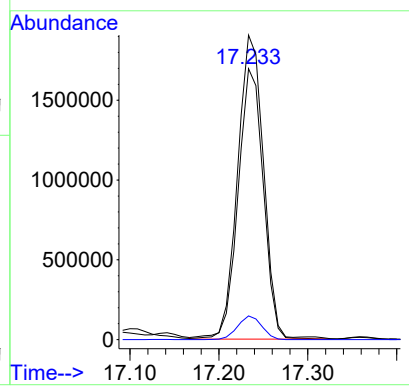
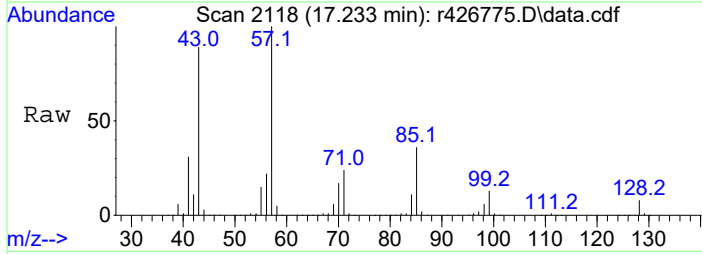

#19  
 C9 - < C10 Aliphatics  
 Concen: 3259.81 ppbV m  
 RT: 17.233 min Scan# 2118  
 Delta R.T. 0.000 min  
 Lab File: r426775.D  
 Acq: 27 Feb 2023 4:14 AM

Tgt Ion:	Resp:	Lower	Upper
TIC	100		
174	0.0	0.0	0.0
75	0.0	0.0	0.0

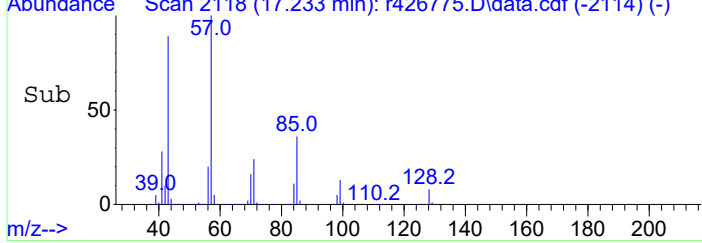
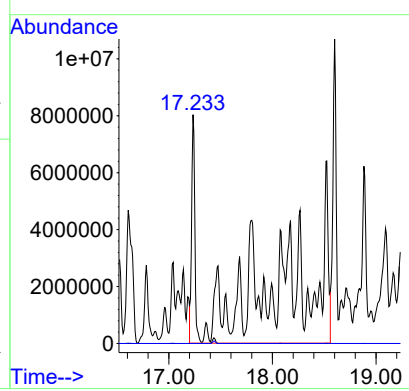
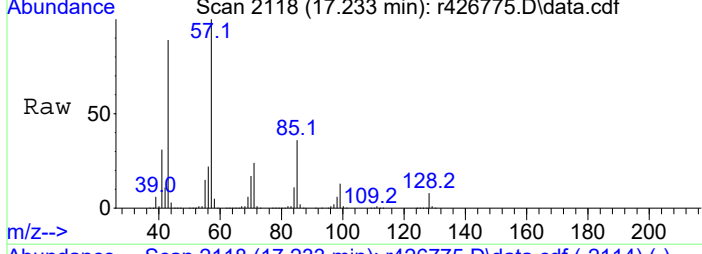

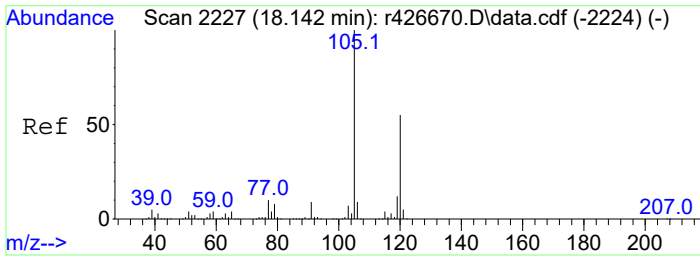

#20  
 1,3,5-trimethylbenzene  
 Concen: 15.42 ppbV  
 RT: 18.175 min Scan# 2231  
 Delta R.T. 0.033 min  
 Lab File: r426775.D  
 Acq: 27 Feb 2023 4:14 AM

Tgt Ion	Resp	Lower	Upper
105	100		
120	55.0	43.7	65.5
91	8.8	7.6	11.4

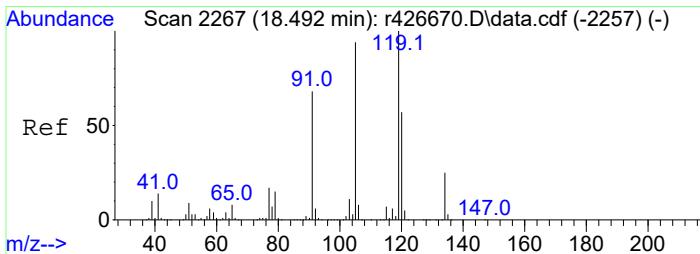
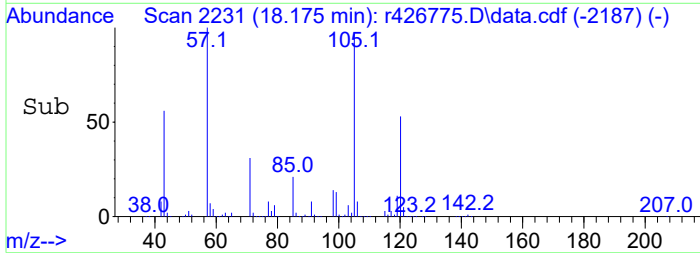
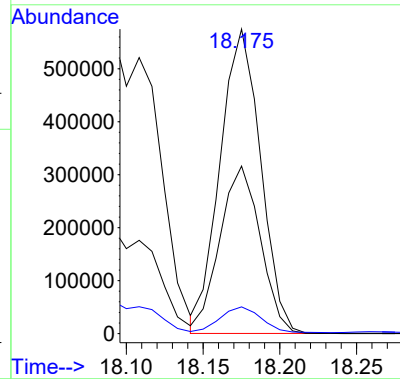
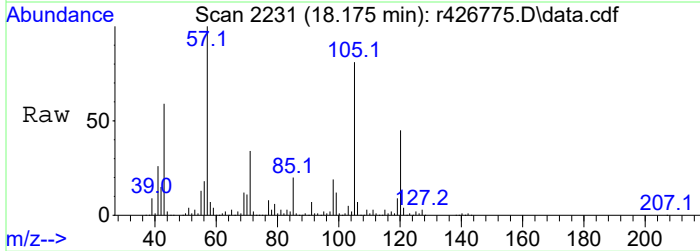

#21  
 1,2,4-Trimethylbenzene  
 Concen: 42.11 ppbV  
 RT: 18.525 min Scan# 2271  
 Delta R.T. 0.033 min  
 Lab File: r426775.D  
 Acq: 27 Feb 2023 4:14 AM

Tgt Ion	Resp	Lower	Upper
105	100		
120	52.9	48.6	73.0
91	9.0	58.3	87.5#

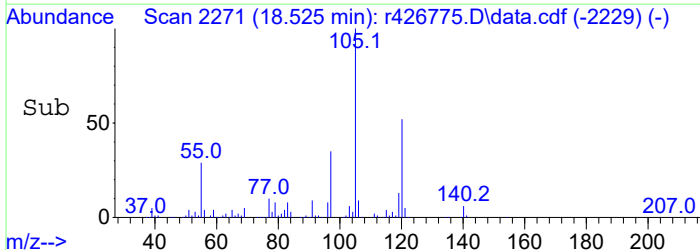
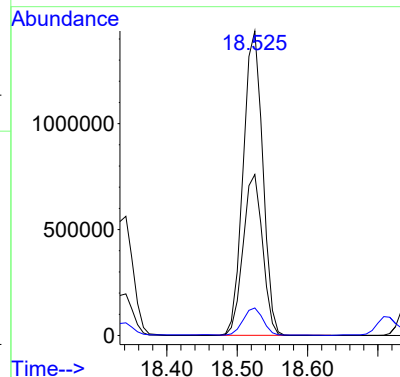
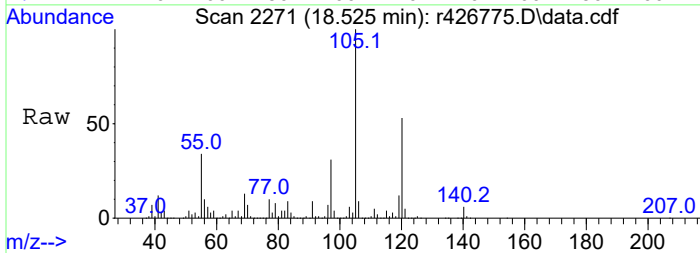

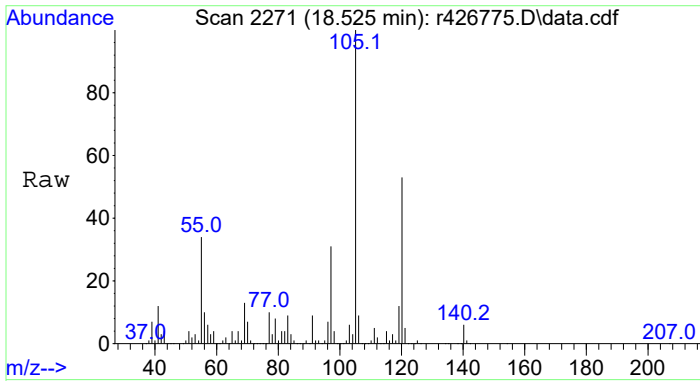

#22  
 C3-Benzenes  
 Concen: 149.01 ppbV m  
 RT: 18.525 min Scan# 2271  
 Delta R.T. 0.000 min  
 Lab File: r426775.D  
 Acq: 27 Feb 2023 4:14 AM

Tgt Ion	Ratio	Lower	Upper
105	100		
120	14.9	42.3	63.5#
91	2.5	7.2	10.8#

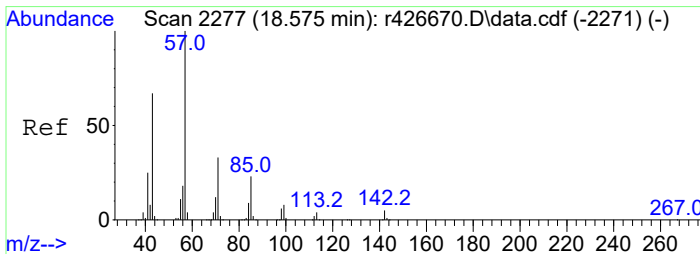
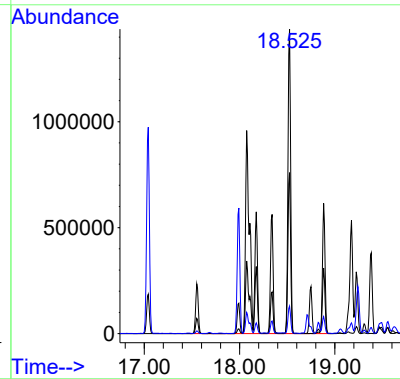
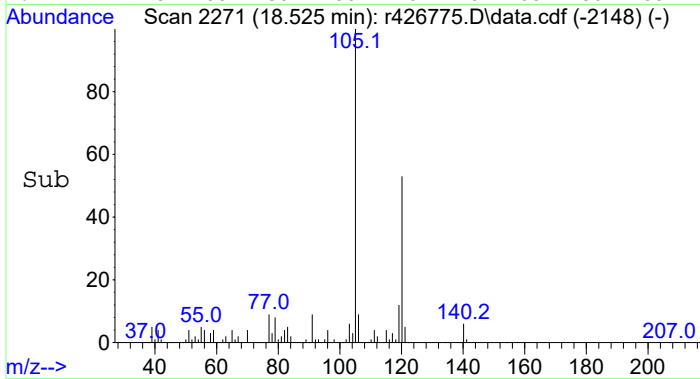

#23  
 decane  
 Concen: 70.15 ppbV  
 RT: 18.600 min Scan# 2280  
 Delta R.T. 0.025 min  
 Lab File: r426775.D  
 Acq: 27 Feb 2023 4:14 AM

Tgt Ion	Ratio	Lower	Upper
57	100		
43	77.1	53.5	80.3
142	6.6	4.0	6.0#

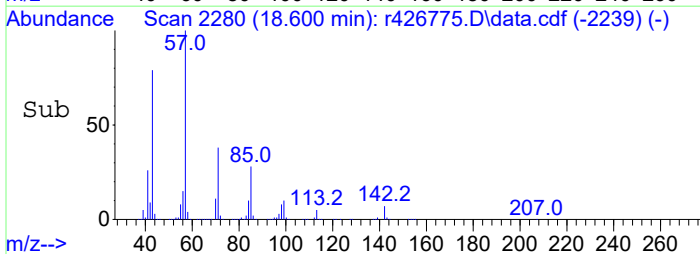
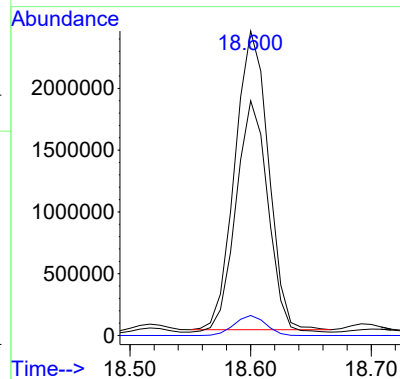
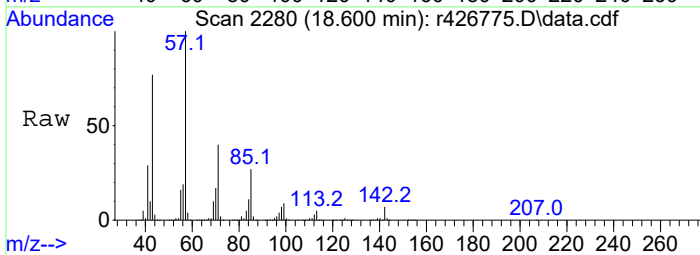

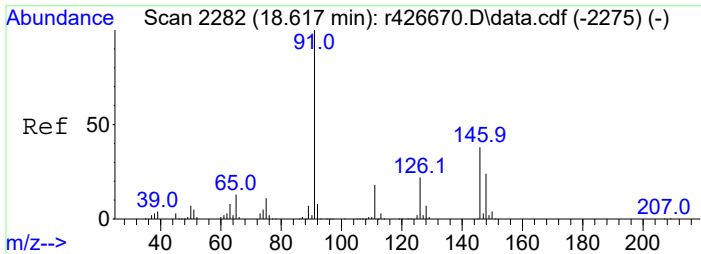

#24  
 C10 - < C11 Aliphatics  
 Concen: 1770.40 ppbV m  
 RT: 18.600 min Scan# 2280  
 Delta R.T. 0.000 min  
 Lab File: r426775.D  
 Acq: 27 Feb 2023 4:14 AM

Tgt Ion:TIC Resp:117891520  
 Ion Ratio Lower Upper  
 TIC 100  
 126 358000.0 2.6 4.0#

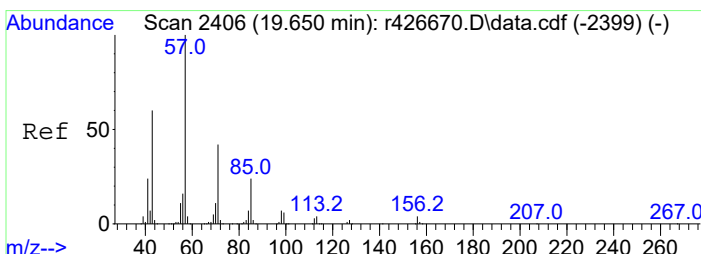
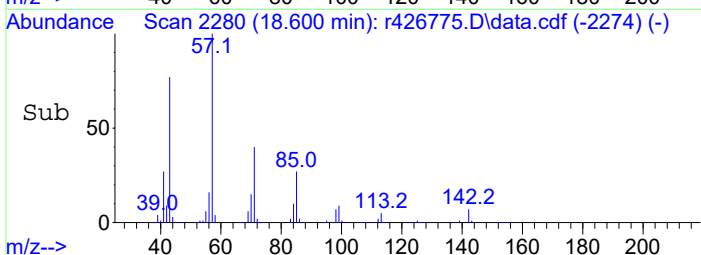
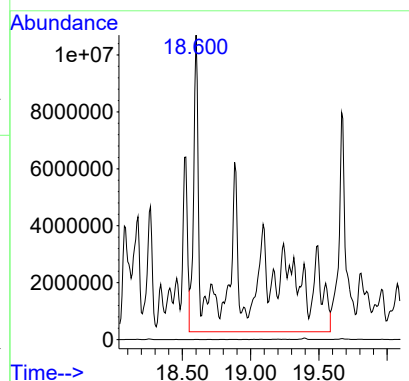
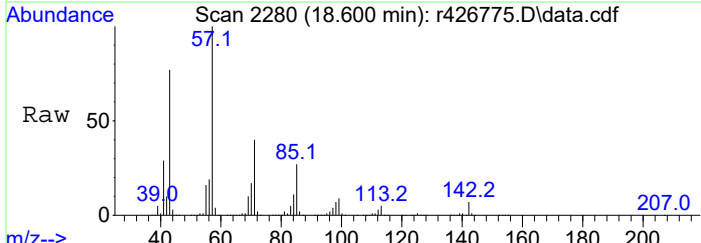

#25  
 undecane  
 Concen: 53.42 ppbV  
 RT: 19.675 min Scan# 2409  
 Delta R.T. 0.025 min  
 Lab File: r426775.D  
 Acq: 27 Feb 2023 4:14 AM

Tgt Ion: 57 Resp: 3788325  
 Ion Ratio Lower Upper  
 57 100  
 43 64.9 48.2 72.2  
 71 45.5 33.5 50.3  
 156 4.8 3.6 5.4

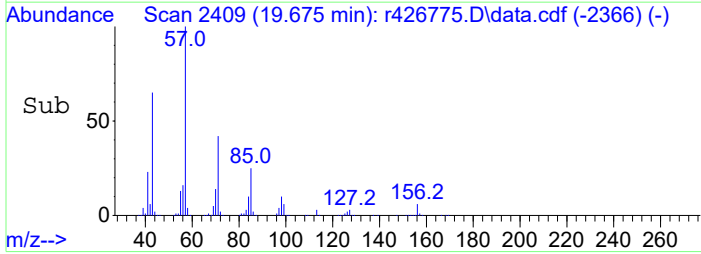
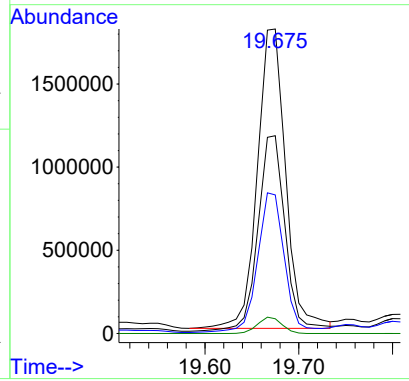
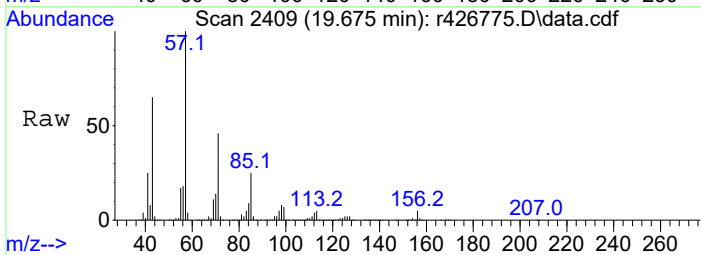

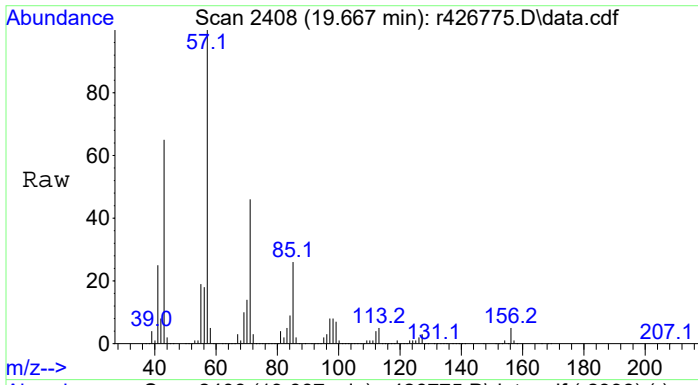

#26  
 C11 - < C12 Aliphatics  
 Concen: 993.18 ppbV m  
 RT: 19.667 min Scan# 2408  
 Delta R.T. -0.000 min  
 Lab File: r426775.D  
 Acq: 27 Feb 2023 4:14 AM  
 Tgt Ion:TIC Resp:70436189

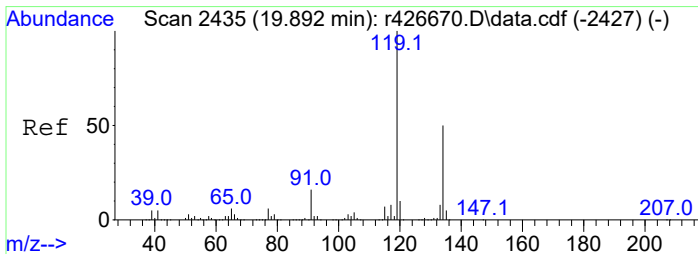
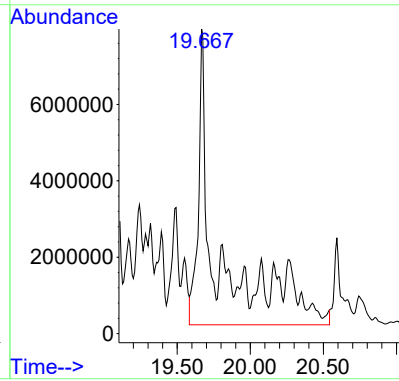
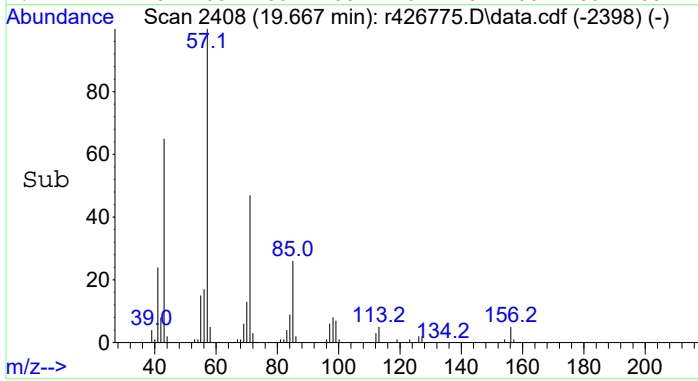

#27  
 1,2,4,5-tetramethylbenzene  
 Concen: 2.62 ppbV  
 RT: 19.908 min Scan# 2437  
 Delta R.T. 0.016 min  
 Lab File: r426775.D  
 Acq: 27 Feb 2023 4:14 AM

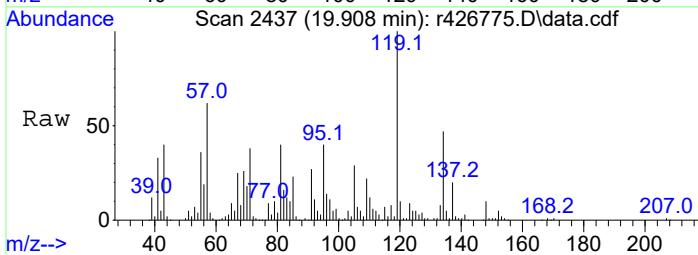

Tgt Ion:119 Resp: 222112  
 Ion Ratio Lower Upper  
 119 100  
 134 47.3 40.2 60.4  
 91 27.1 13.2 19.8#

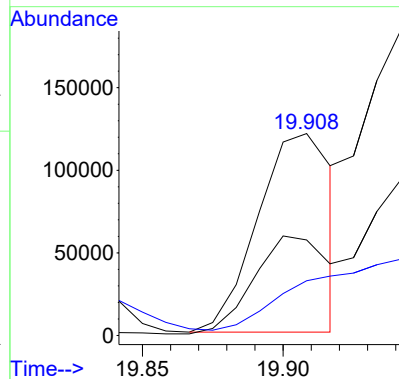
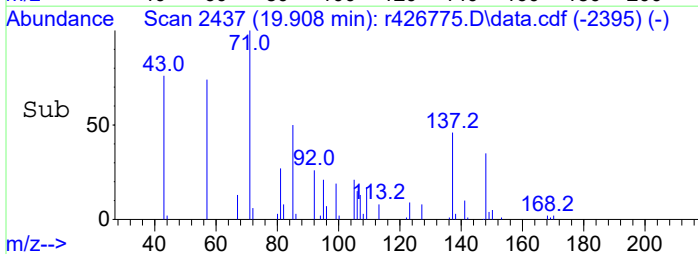

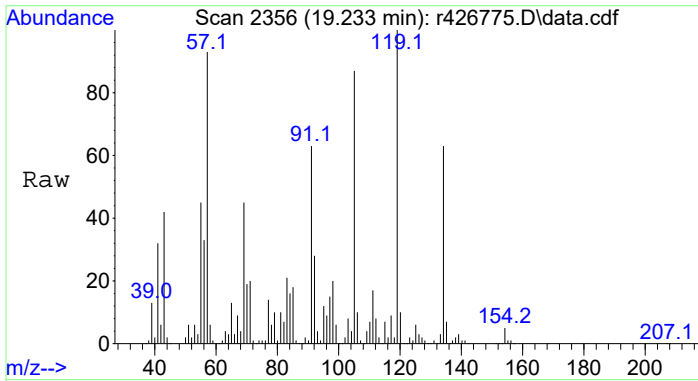

#28  
 C4-Benzenes  
 Concen: 27.89 ppbV m  
 RT: 19.233 min Scan# 2356  
 Delta R.T. 0.000 min  
 Lab File: r426775.D  
 Acq: 27 Feb 2023 4:14 AM

Tgt Ion	Resp	Lower	Upper
134	100		
120	2.6	12.5	18.7#
91	19.7	79.6	119.4#

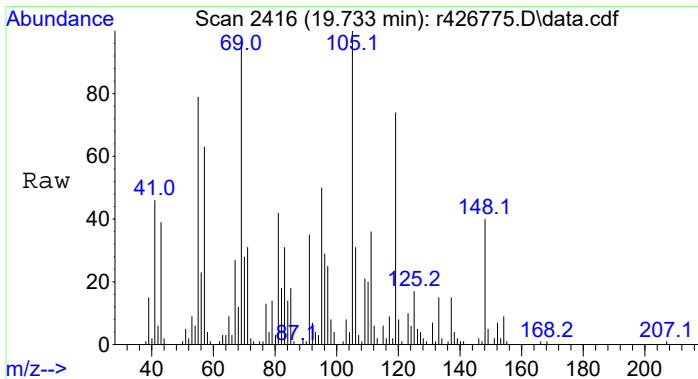
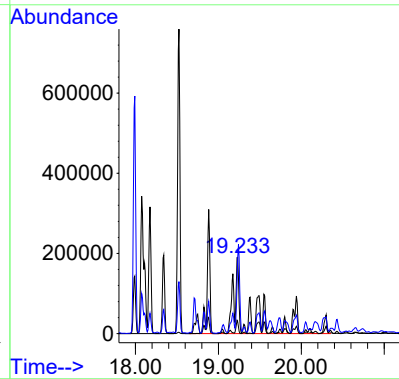
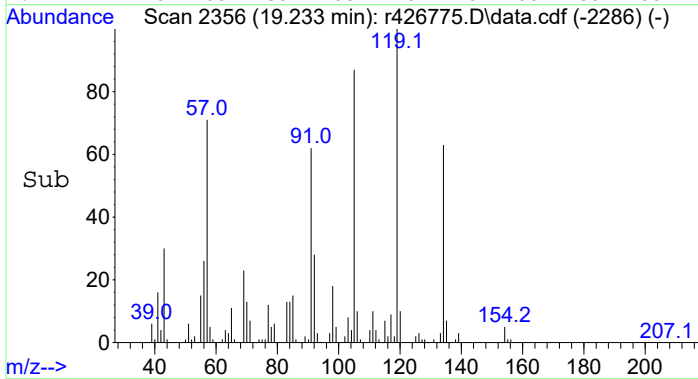

#29  
 C5-Benzenes  
 Concen: 7.74 ppbV m  
 RT: 19.733 min Scan# 2416  
 Delta R.T. 0.000 min  
 Lab File: r426775.D  
 Acq: 27 Feb 2023 4:14 AM

Tgt Ion	Resp	Lower	Upper
148	100		
134	0.0	3.4	5.0#
91	16.0	71.0	106.6#

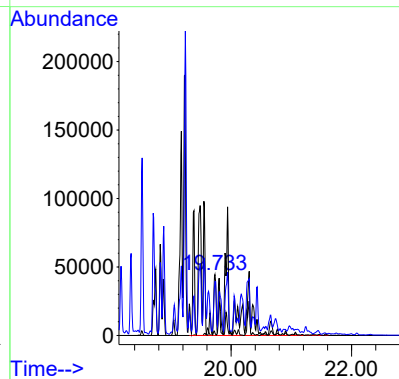
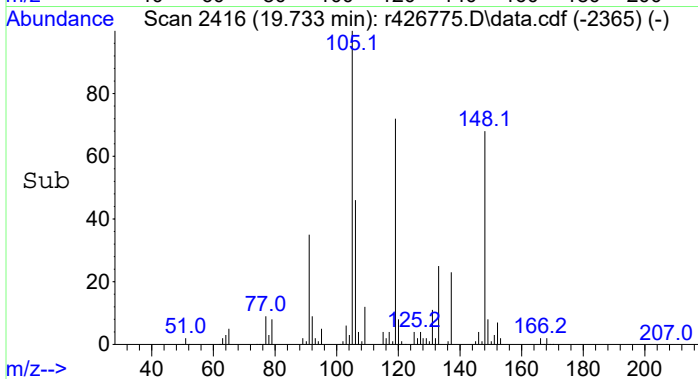



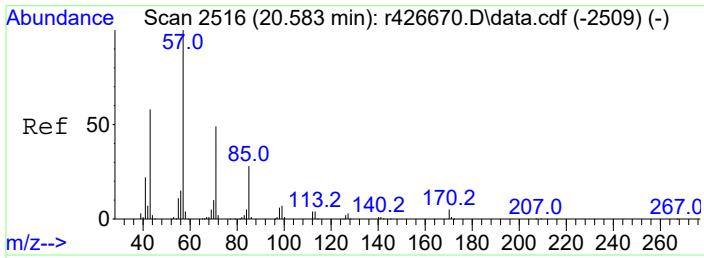

#30  
 dodecane  
 Concen: 17.25 ppbV  
 RT: 20.592 min Scan# 2517  
 Delta R.T. 0.009 min  
 Lab File: r426775.D  
 Acq: 27 Feb 2023 4:14 AM

Tgt Ion: 57 Resp: 1120887  
 Ion Ratio Lower Upper  
 57 100  
 43 54.4 46.3 69.5

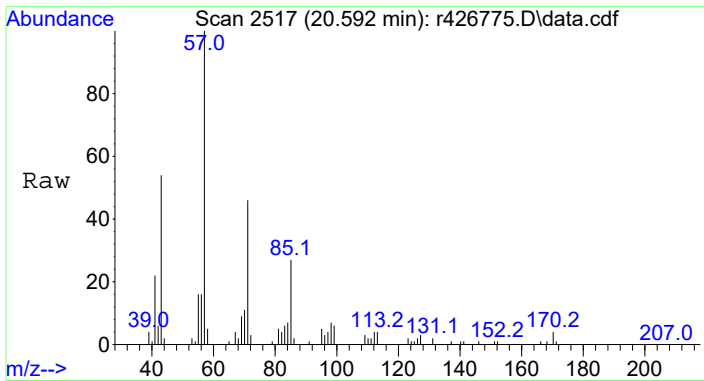
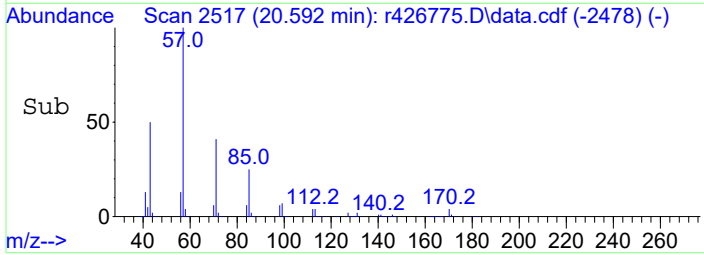
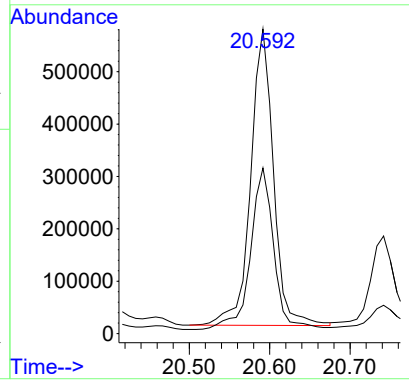
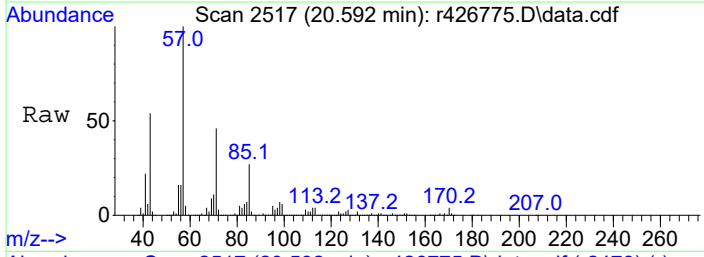

#31  
 C12 + Aliphatics  
 Concen: 522.50 ppbV m  
 RT: 20.592 min Scan# 2517  
 Delta R.T. 0.000 min  
 Lab File: r426775.D  
 Acq: 27 Feb 2023 4:14 AM

Tgt Ion:TIC Resp:33943968

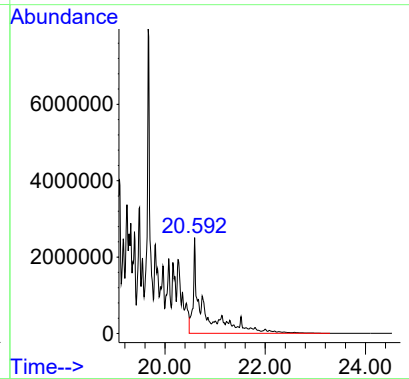
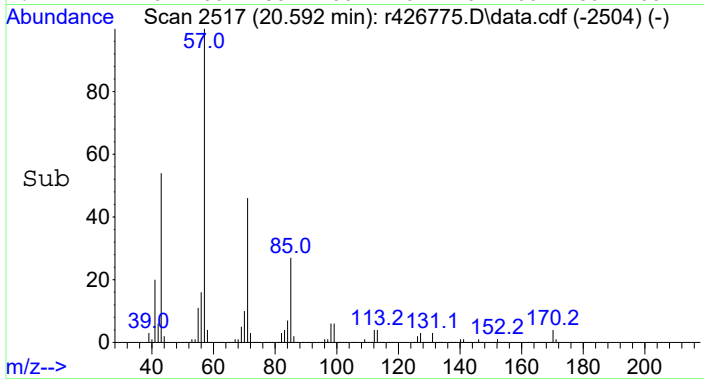

Data Path : C:\PROJECTS\HAWAII DOH\2. LABORATORY DATA\ALPHA\WAF STUDY\L2317092\TO15-LL\NF TO-15\  
 Data File : r427472.D  
 Acq On : 21 Apr 2023 6:24 AM  
 Operator : AIRPIANO4:RAY  
 Sample : L2317092-01D,3,0.99,250  
 Misc : WG1769204,ICAL19932  
 ALS Vial : 0 Sample Multiplier: 1

Quant Time: Jul 28 15:04:44 2023  
 Quant Method : C:\Projects\Hawaii DOH\2. Laboratory Data\Alpha\WAF Study\L2317092\TO15-LL\NF TO-15\TFS19 230501 NF.M  
 Quant Title : TO-14A/TO-15 SIM/Full Scan Analysis  
 QLast Update : Fri Jul 28 14:28:27 2023  
 Response via : Initial Calibration

Compound	R.T.	QIon	Response	Conc	Units	Dev (Min)	
Internal Standards							
1) bromochloromethane	9.117	49	303925	10.00	ppbV	0.00	
4) 1,4-difluorobenzene	11.313	114	948676	10.00	ppbV	0.00	
11) chlorobenzene-D5	16.000	54	135310	10.00	ppbV	0.00	
							Qvalue
Target Compounds							
2) pentane	6.303	43	356075	15.45	ppbV		100
3) C5 - < C6 Aliphatics	6.740	TIC	5653621m	245.32	ppbV		
5) hexane	9.183	57	369743	12.09	ppbV		100
6) C6 - < C7 Aliphatics	11.313	TIC	13708827m	448.41	ppbV		
7) benzene	10.900	78	215302	3.75	ppbV		100
8) C1 - Benzenes	10.900	78	215302	3.75	ppbV		100
9) heptane	12.473	43	687838	18.27	ppbV		100
10) C7 - C8 Aliphatics	15.275	TIC	46845087m	1244.52	ppbV		
12) toluene	14.258	91	1715852	28.40	ppbV		100
13) octane	15.275	85	1048577	37.97	ppbV		100
14) ethylbenzene	16.392	91	1103540	14.57	ppbV		100
15) m+p-xylene	16.550	91	3041958	49.03	ppbV		100
16) o-xylene	16.975	91	1522245	24.71	ppbV		100
17) C2-Benzenes	16.550	91	5685990m	92.31	ppbV		
18) nonane	17.175	43	2799074	49.64	ppbV		100
19) C9 - < C10 Aliphatics	17.175	TIC	115262194m	2044.22	ppbV		
20) 1,3,5-trimethylbenzene	18.117	105	826095	10.26	ppbV		100
21) 1,2,4-Trimethylbenzene	18.467	105	2310110	30.49	ppbV		100
22) C3-Benzenes	18.467	105	7360097m	97.13	ppbV		
23) decane	18.542	57	3121889	46.97	ppbV		100
24) C10 - < C11 Aliphatics	18.542	TIC	81223347m	1222.02	ppbV		
25) undecane	19.617	57	2276162	32.05	ppbV		100
26) C11 - < C12 Aliphatics	19.617	TIC	48932549m	688.97	ppbV		
27) 1,2,4,5-tetramethylben...	19.892	119	251757	6.53	ppbV		100
28) C4-Benzenes	19.167	134	1587693m	41.18	ppbV		
29) C5-Benzenes	19.675	148	457220m	11.86	ppbV		
30) dodecane	20.542	57	530275	8.03	ppbV		100
31) C12 + Aliphatics	19.617	TIC	73132420m	1108.02	ppbV		

(#) = qualifier out of range (m) = manual integration (+) = signals summed

Data Path : C:\PROJECTS\HAWAII DOH\2. LABORATORY DATA\ALPHA\WAF STUDY\L2317092\TO15-LL\NF TO-15\  
 Data File : r427472.D  
 Acq On : 21 Apr 2023 6:24 AM  
 Operator : AIRPIANO4:RAY  
 Sample : L2317092-01D,3,0.99,250  
 Misc : WG1769204,ICAL19932  
 ALS Vial : 0 Sample Multiplier: 1

Quant Time: Jul 28 15:04:44 2023  
 Quant Method : C:\Projects\Hawaii DOH\2. Laboratory Data\Alpha\WAF Study\L2317092\TO15-LL\NF TO-15\TFS19 230501 NF.M  
 Quant Title : TO-14A/TO-15 SIM/Full Scan Analysis  
 QLast Update : Fri Jul 28 14:28:27 2023  
 Response via : Initial Calibration

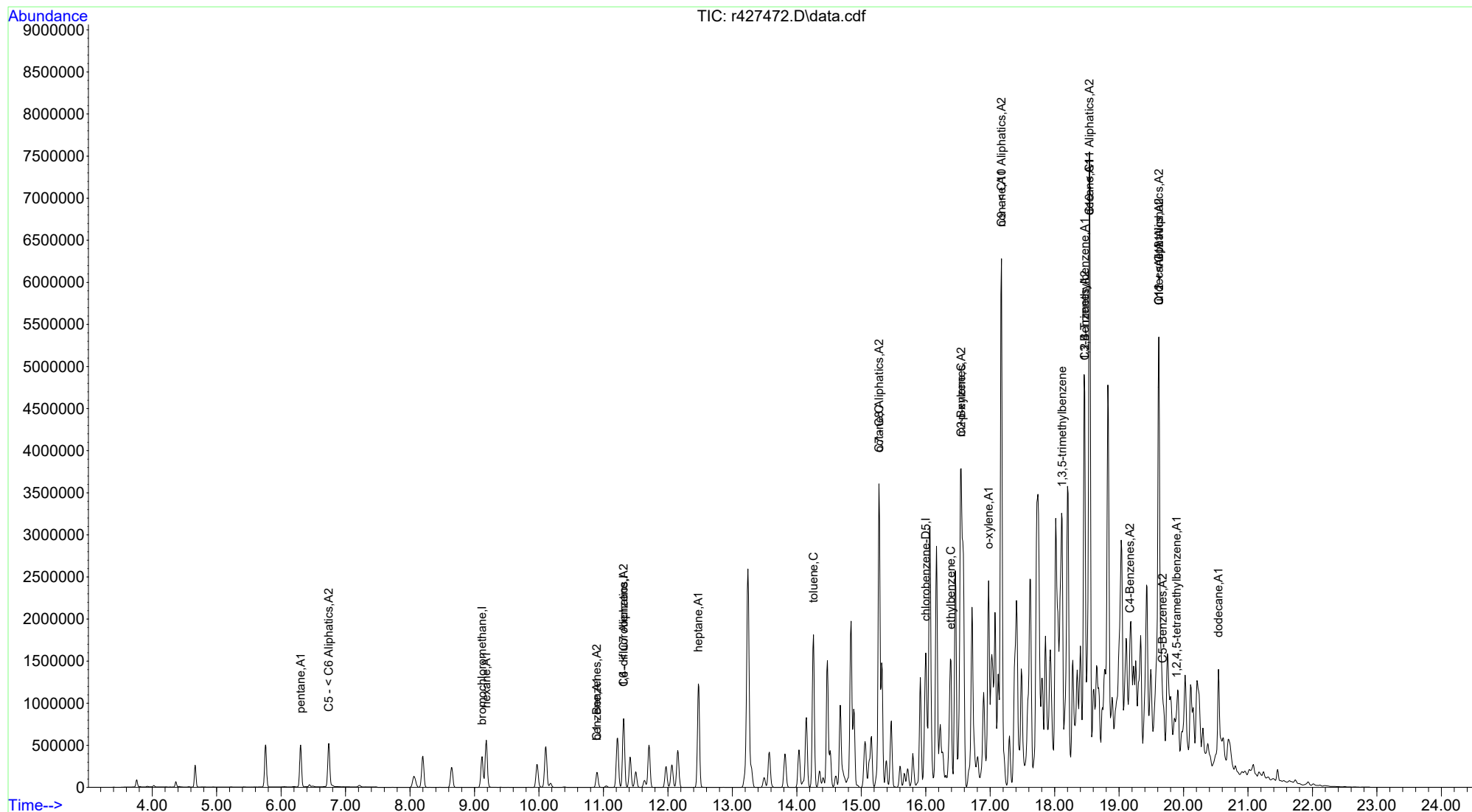

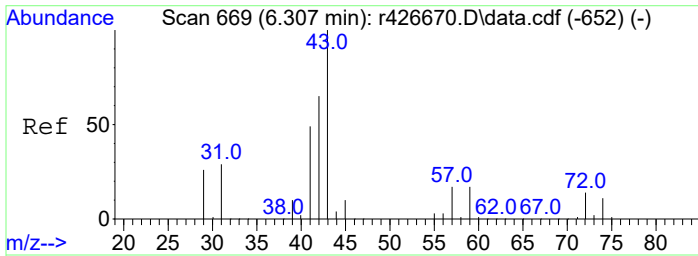

#2  
 pentane  
 Concen: 15.45 ppbV  
 RT: 6.303 min Scan# 668  
 Delta R.T. 0.000 min  
 Lab File: r427472.D  
 Acq: 21 Apr 2023 6:24 AM

Tgt Ion	Resp	Lower	Upper
43	100		
57	18.3	14.6	22.0
72	13.1	10.5	15.7

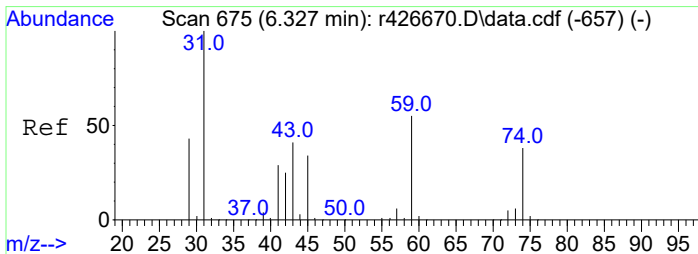
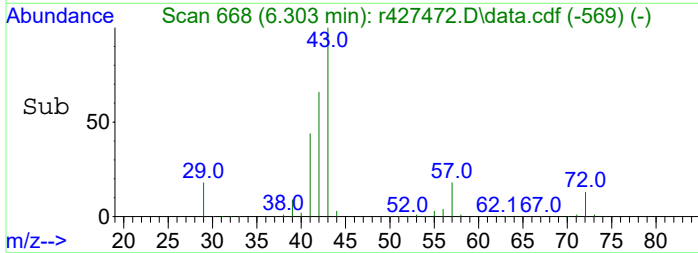
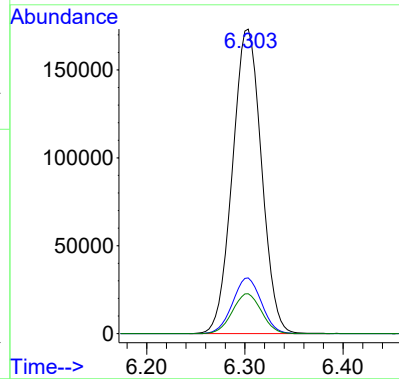
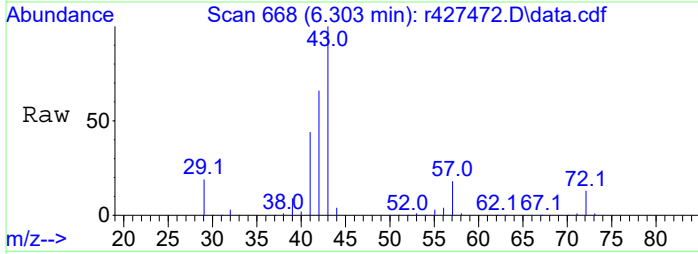

#3  
 C5 - < C6 Aliphatics  
 Concen: 245.32 ppbV m  
 RT: 6.740 min Scan# 764  
 Delta R.T. 0.000 min  
 Lab File: r427472.D  
 Acq: 21 Apr 2023 6:24 AM

Tgt Ion	Resp	Lower	Upper
TIC	100		
59	0.0	0.0	0.0
45	0.0	0.0	0.0

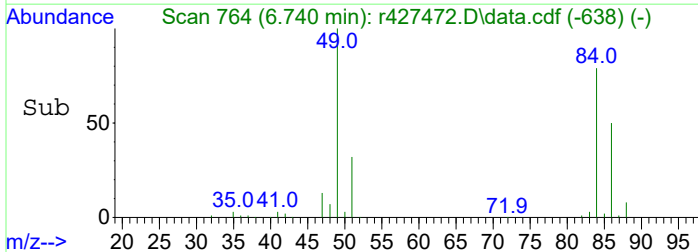
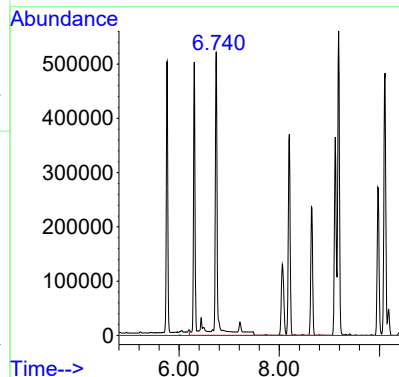
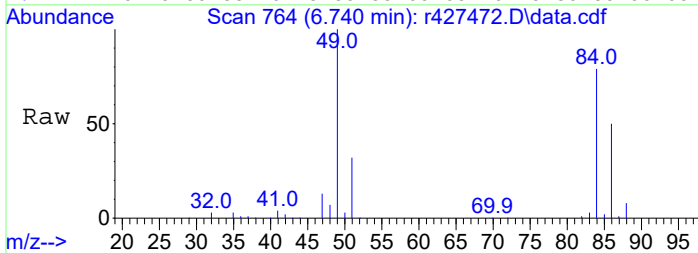

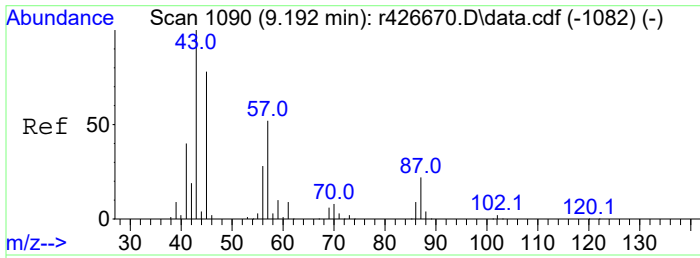

#5  
 hexane  
 Concen: 12.09 ppbV  
 RT: 9.183 min Scan# 1089  
 Delta R.T. 0.000 min  
 Lab File: r427472.D  
 Acq: 21 Apr 2023 6:24 AM

Tgt Ion: 57 Resp: 369743

Ion	Ratio	Lower	Upper
57	100		
43	57.1	45.7	68.5
86	18.8	15.0	22.6

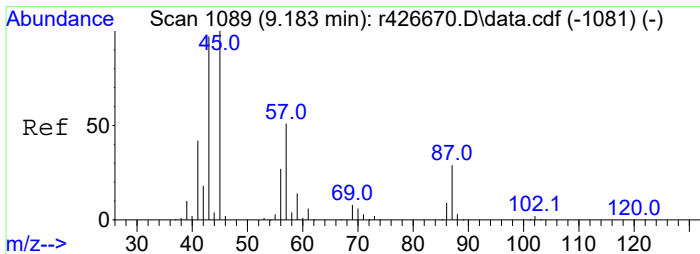
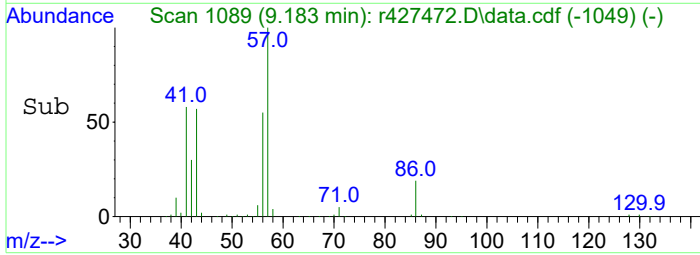
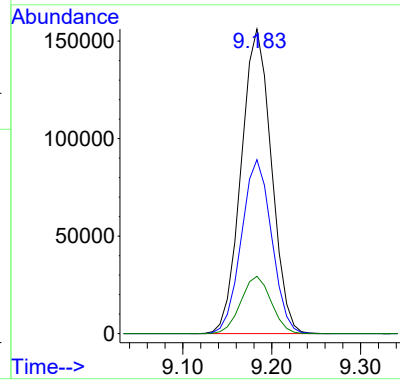
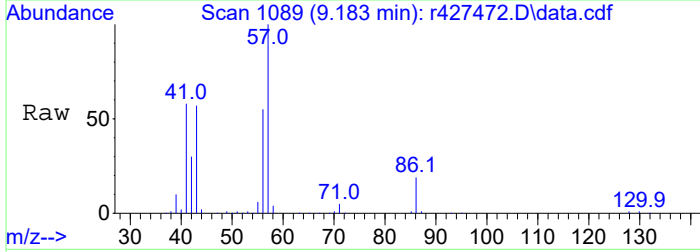

#6  
 C6 - < C7 Aliphatics  
 Concen: 448.41 ppbV m  
 RT: 11.313 min Scan# 1364  
 Delta R.T. 0.000 min  
 Lab File: r427472.D  
 Acq: 21 Apr 2023 6:24 AM

Tgt Ion:TIC Resp:13708827

Ion	Ratio	Lower	Upper
TIC	100		
59	0.0	0.0	0.0
45	98300.0	9.6	14.4#

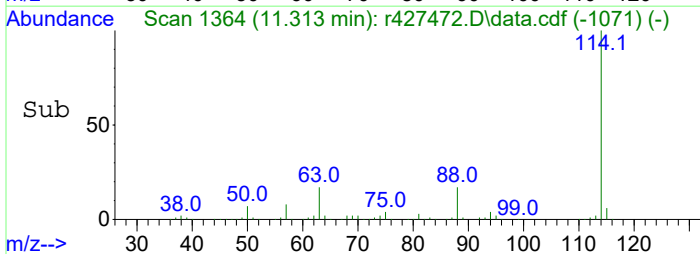
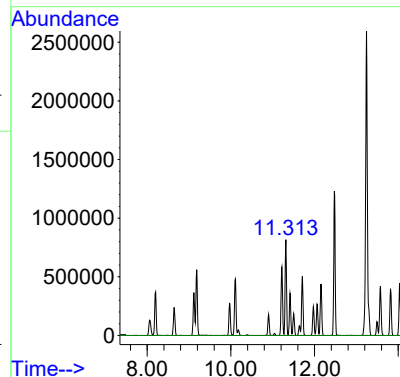
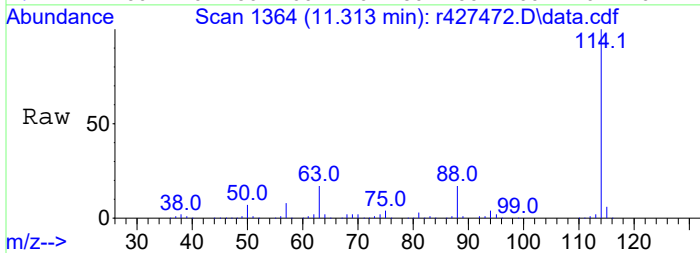

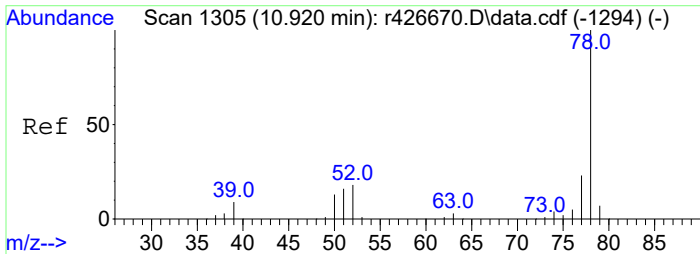

#7  
benzene  
Concen: 3.75 ppbV  
RT: 10.900 min Scan# 1302  
Delta R.T. 0.000 min  
Lab File: r427472.D  
Acq: 21 Apr 2023 6:24 AM

Tgt Ion	Resp	Lower	Upper
78	100		
52	16.0	12.8	19.2

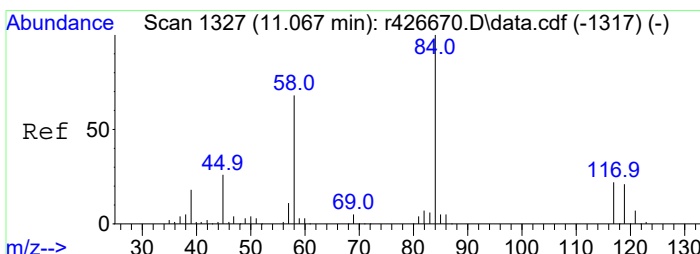
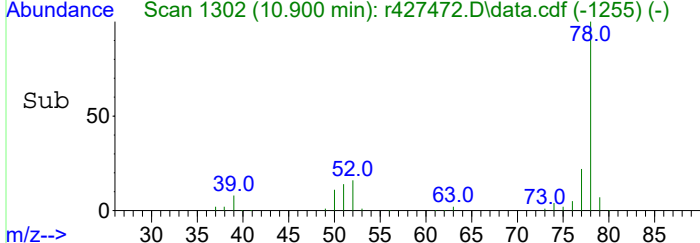
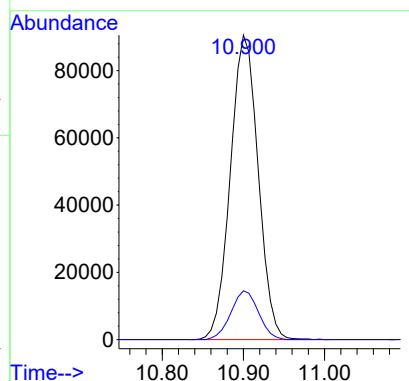
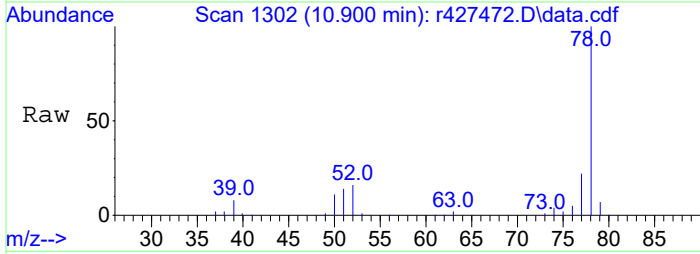

#8  
C1 - Benzenes  
Concen: 3.75 ppbV  
RT: 10.900 min Scan# 1302  
Delta R.T. 0.000 min  
Lab File: r427472.D  
Acq: 21 Apr 2023 6:24 AM

Tgt Ion	Resp	Lower	Upper
78	100		
52	16.0	12.8	19.2

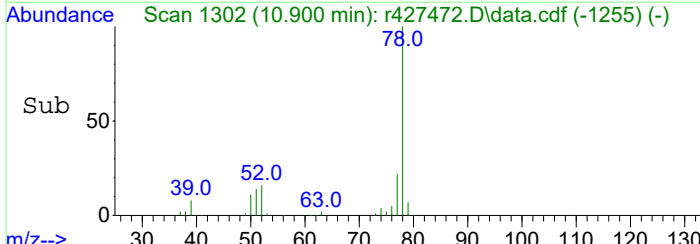
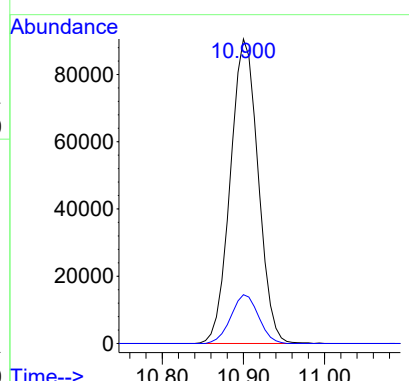
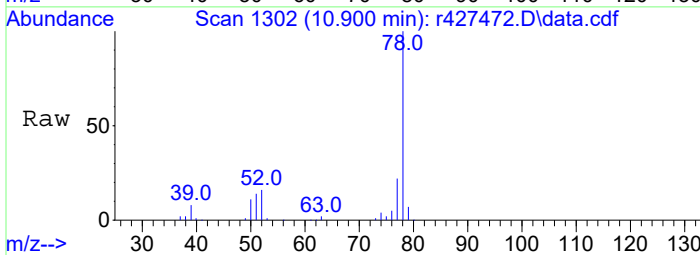

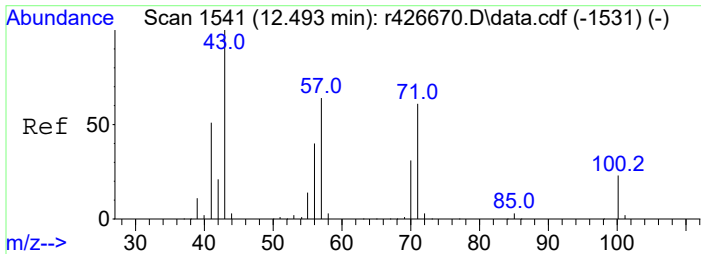

#9  
 heptane  
 Concen: 18.27 ppbV  
 RT: 12.473 min Scan# 1538  
 Delta R.T. 0.000 min  
 Lab File: r427472.D  
 Acq: 21 Apr 2023 6:24 AM

Tgt Ion	Resp	Lower	Upper
43	100		
57	55.9	44.7	67.1
100	20.1	16.1	24.1

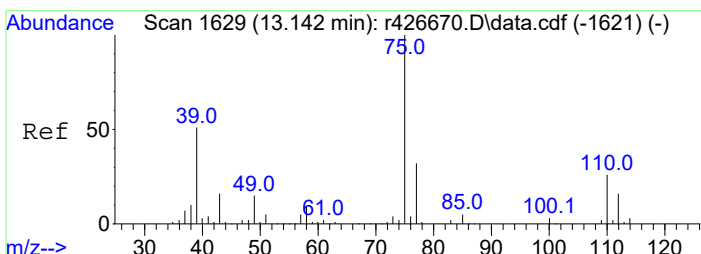
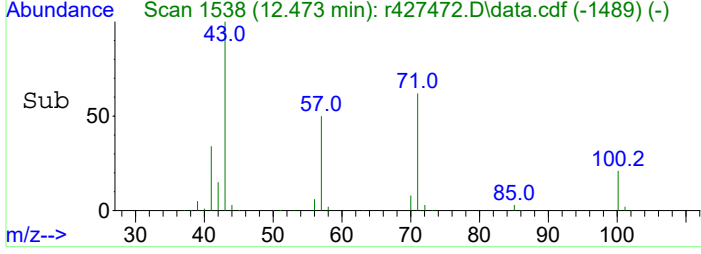
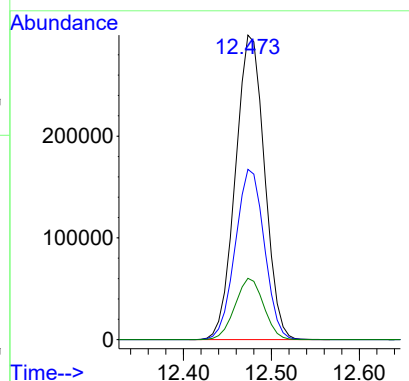
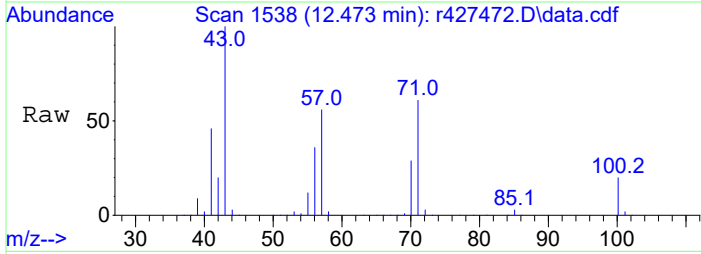

#10  
 C7 - C8 Aliphatics  
 Concen: 1244.52 ppbV m  
 RT: 15.275 min Scan# 1885  
 Delta R.T. 0.000 min  
 Lab File: r427472.D  
 Acq: 21 Apr 2023 6:24 AM

Tgt Ion	Resp	Lower	Upper
TIC	100		
39	5826200.0	129.3	193.9#
77	67300.0	1.5	2.3#

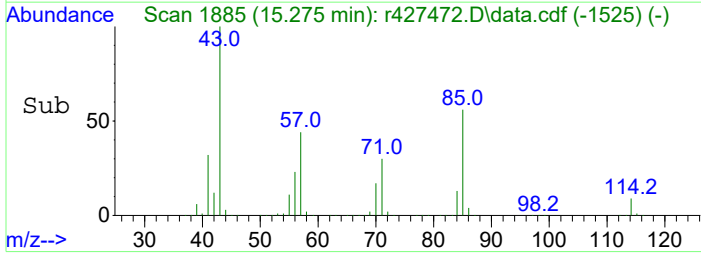
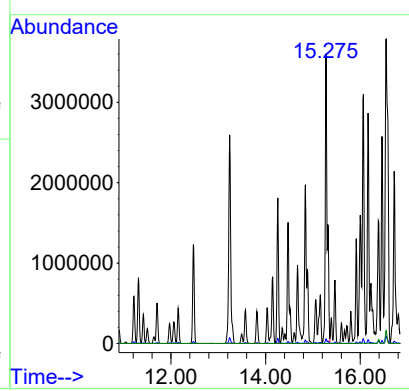
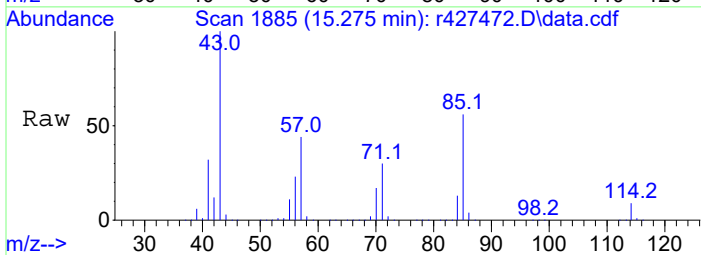

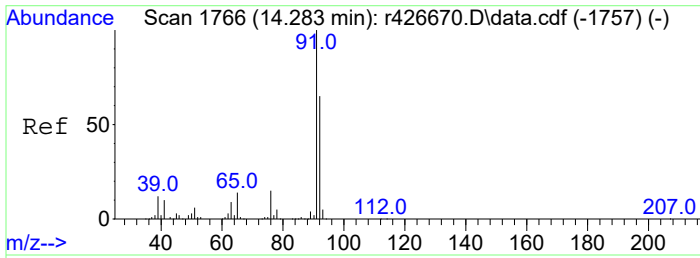

#12  
toluene  
Concen: 28.40 ppbV  
RT: 14.258 min Scan# 1763  
Delta R.T. 0.000 min  
Lab File: r427472.D  
Acq: 21 Apr 2023 6:24 AM

Tgt Ion	Resp	Lower	Upper
91	100		
92	64.5	51.6	77.4

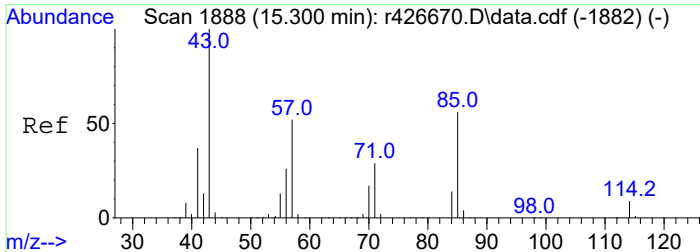
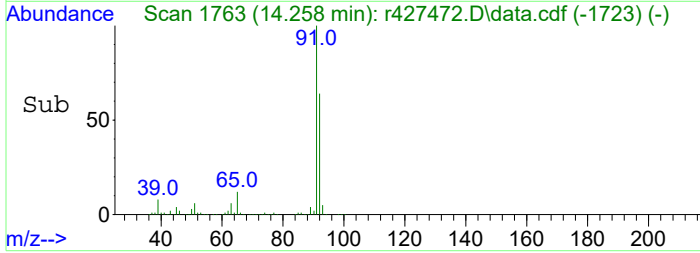
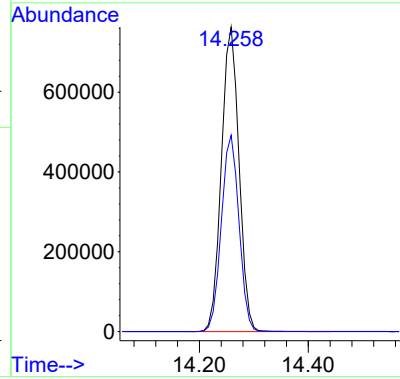
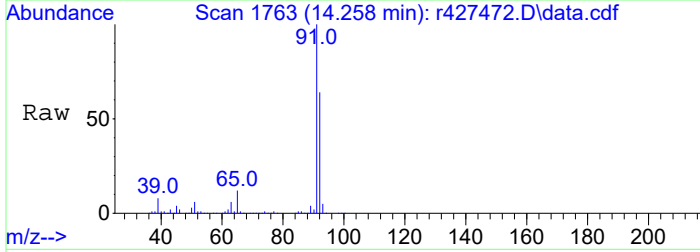

#13  
octane  
Concen: 37.97 ppbV  
RT: 15.275 min Scan# 1885  
Delta R.T. 0.000 min  
Lab File: r427472.D  
Acq: 21 Apr 2023 6:24 AM

Tgt Ion	Resp	Lower	Upper
85	100		
57	79.7	63.8	95.6
114	15.7	12.6	18.8
43	179.5	143.6	215.4

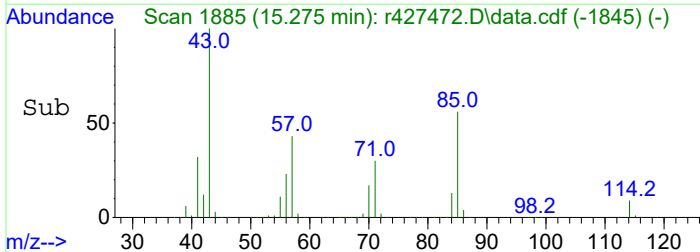
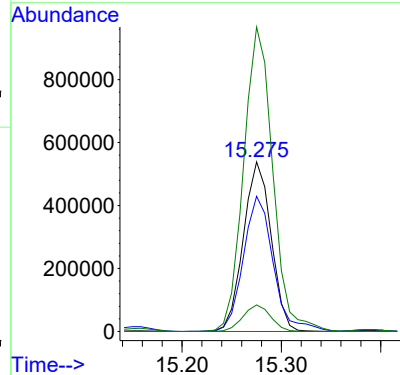
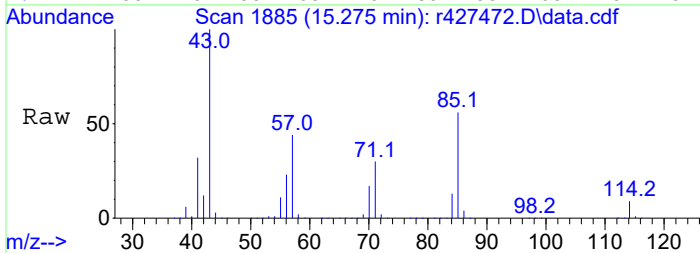



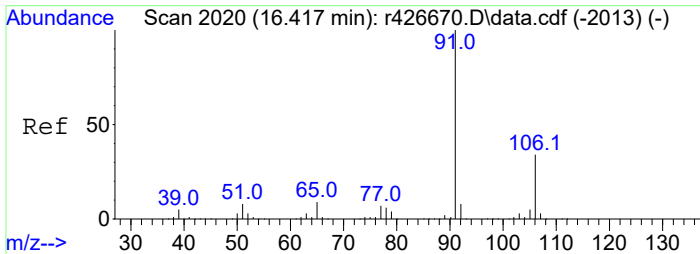

#14  
ethylbenzene  
Concen: 14.57 ppbV  
RT: 16.392 min Scan# 2017  
Delta R.T. 0.000 min  
Lab File: r427472.D  
Acq: 21 Apr 2023 6:24 AM

Tgt Ion: 91 Resp: 1103540  
Ion Ratio Lower Upper  
91 100  
106 39.7 31.8 47.6

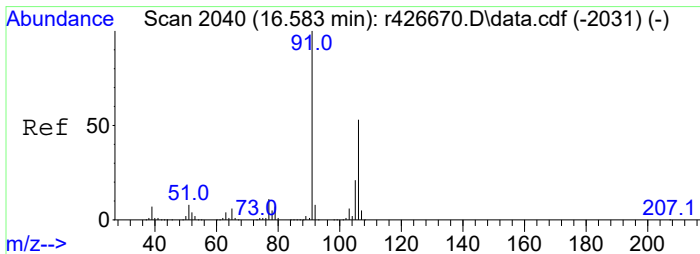
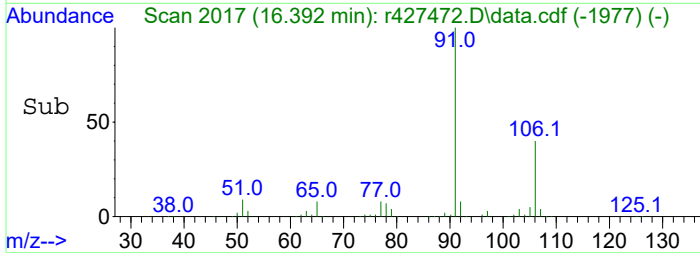
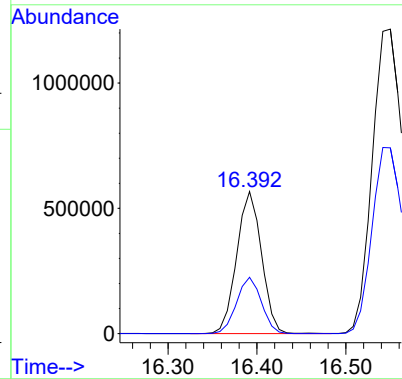
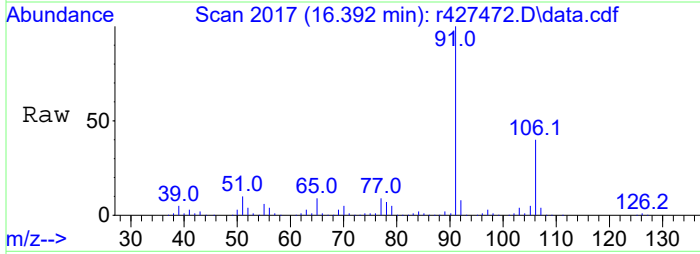

#15  
m+p-xylene  
Concen: 49.03 ppbV  
RT: 16.550 min Scan# 2036  
Delta R.T. 0.000 min  
Lab File: r427472.D  
Acq: 21 Apr 2023 6:24 AM

Tgt Ion: 91 Resp: 3041958  
Ion Ratio Lower Upper  
91 100  
106 61.0 48.8 73.2

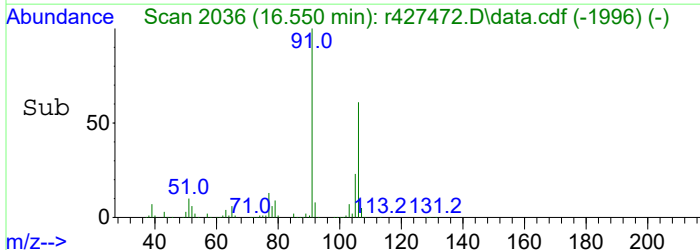
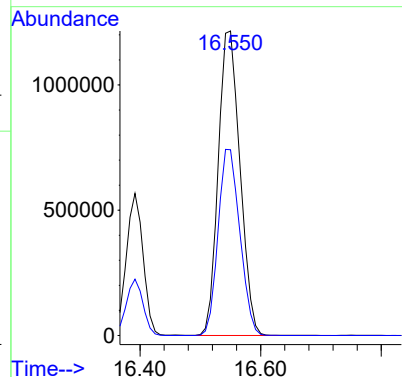
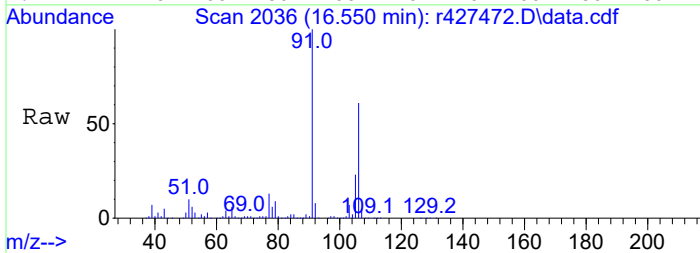

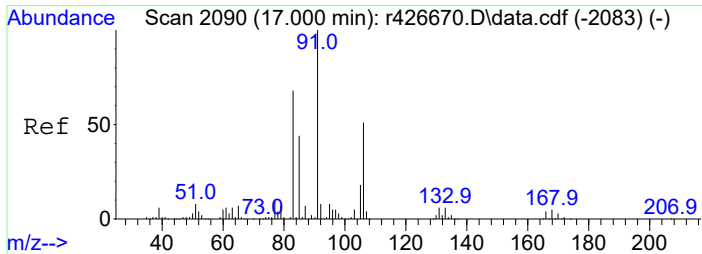

#16  
 o-xylene  
 Concen: 24.71 ppbV  
 RT: 16.975 min Scan# 2087  
 Delta R.T. 0.000 min  
 Lab File: r427472.D  
 Acq: 21 Apr 2023 6:24 AM

Tgt Ion:	91	106	58.6	46.9	70.3
Resp:	1522245				
Ion Ratio	100				
Lower					
Upper					

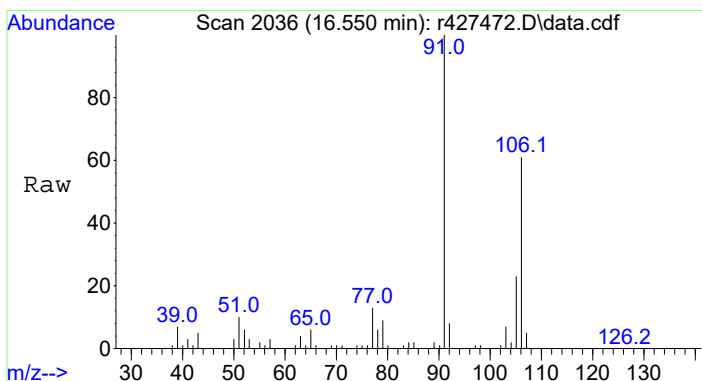
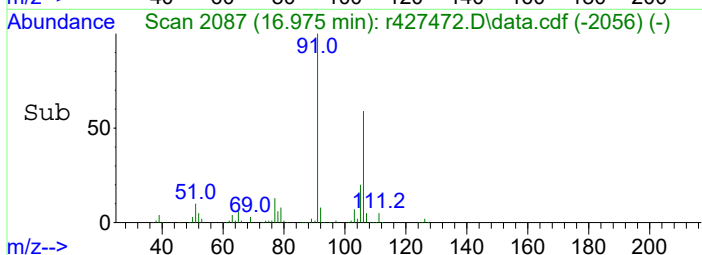
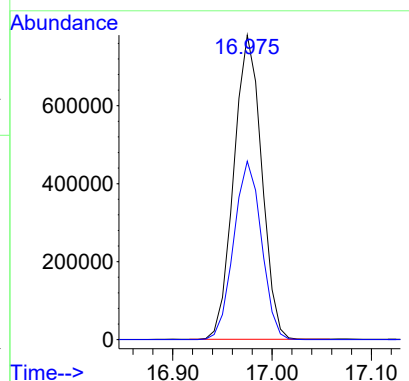
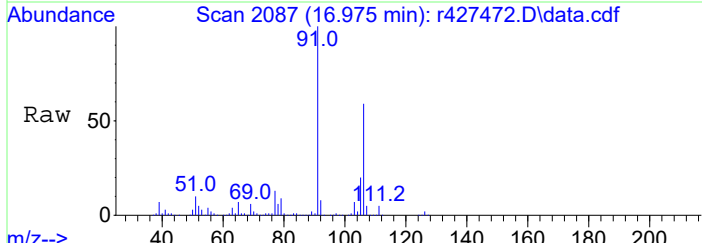

#17  
 C2-Benzenes  
 Concen: 92.31 ppbV m  
 RT: 16.550 min Scan# 2036  
 Delta R.T. 0.000 min  
 Lab File: r427472.D  
 Acq: 21 Apr 2023 6:24 AM

Tgt Ion:	91	106	61.0	48.8	73.2
Resp:	5685990				
Ion Ratio	100				
Lower					
Upper					

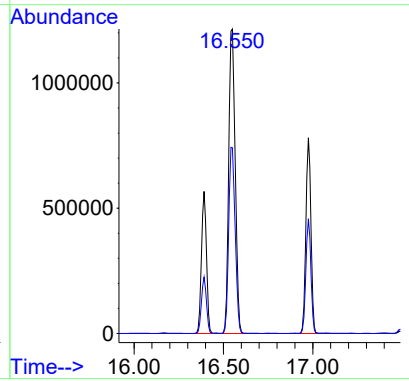
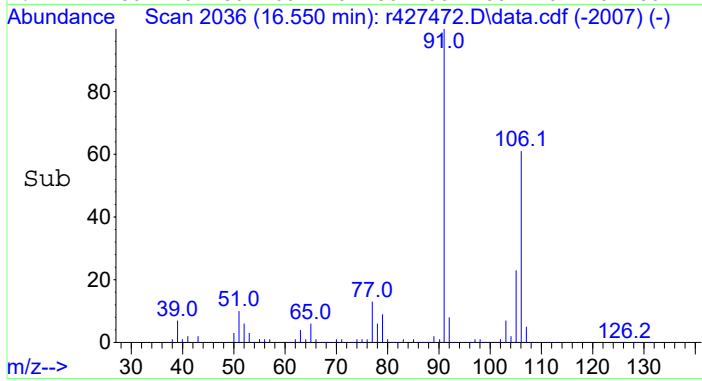

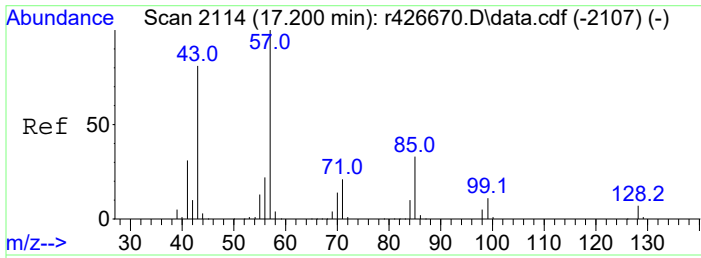

#18  
 nonane  
 Concen: 49.64 ppbV  
 RT: 17.175 min Scan# 2111  
 Delta R.T. 0.000 min  
 Lab File: r427472.D  
 Acq: 21 Apr 2023 6:24 AM

Tgt Ion:	Resp:	Lower	Upper
43	100		
57	99.6	79.7	119.5
128	7.7	6.2	9.2

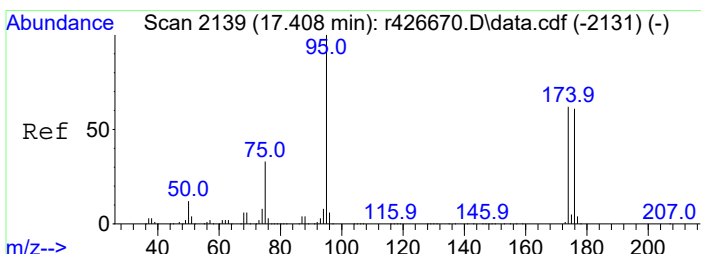
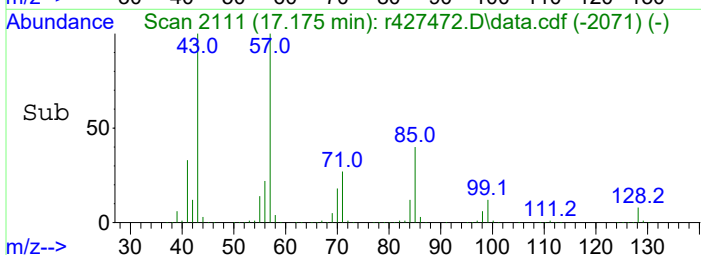
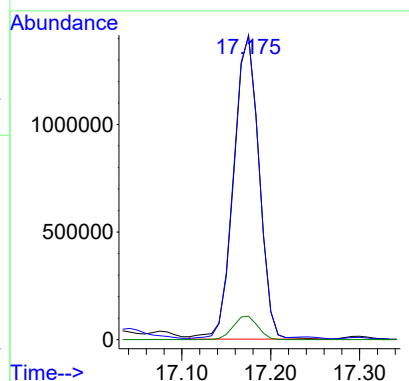
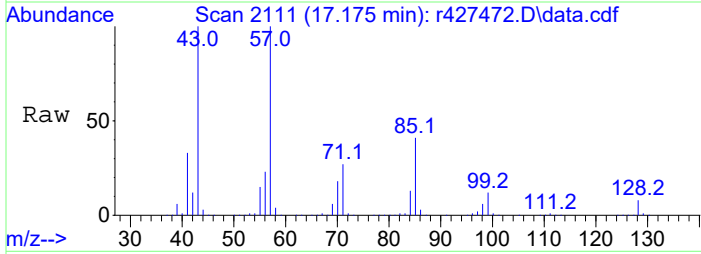

#19  
 C9 - < C10 Aliphatics  
 Concen: 2044.22 ppbV m  
 RT: 17.175 min Scan# 2111  
 Delta R.T. 0.000 min  
 Lab File: r427472.D  
 Acq: 21 Apr 2023 6:24 AM

Tgt Ion:	Resp:	Lower	Upper
TIC	100		
174	0.0	0.0	0.0
75	0.0	0.0	0.0

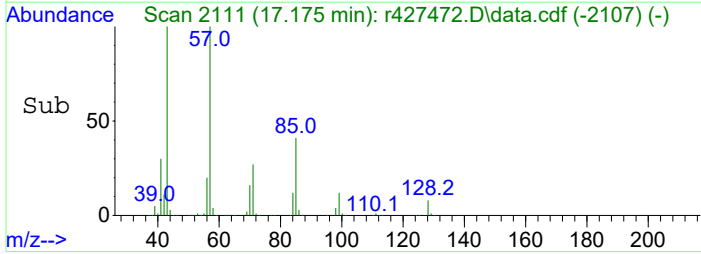
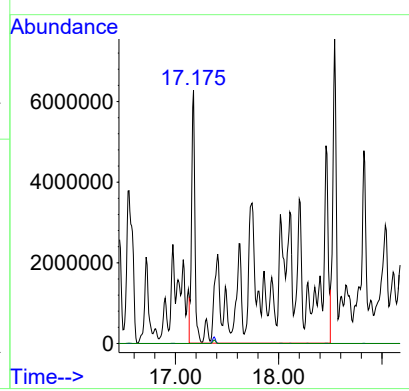
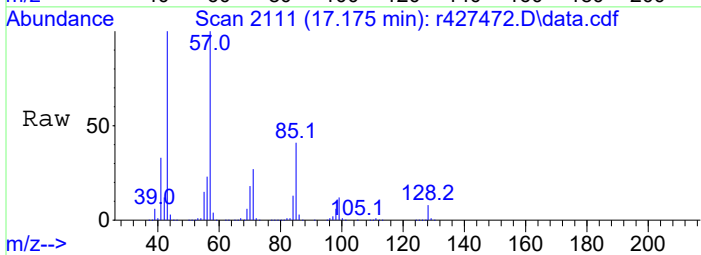

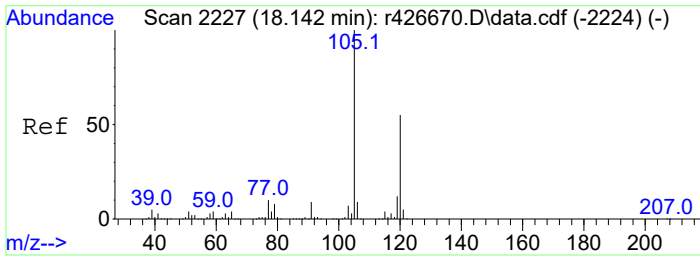

#20  
 1,3,5-trimethylbenzene  
 Concen: 10.26 ppbV  
 RT: 18.117 min Scan# 2224  
 Delta R.T. 0.000 min  
 Lab File: r427472.D  
 Acq: 21 Apr 2023 6:24 AM

Tgt Ion	Resp	Lower	Upper
105	100		
120	55.8	44.6	67.0
91	8.5	6.8	10.2

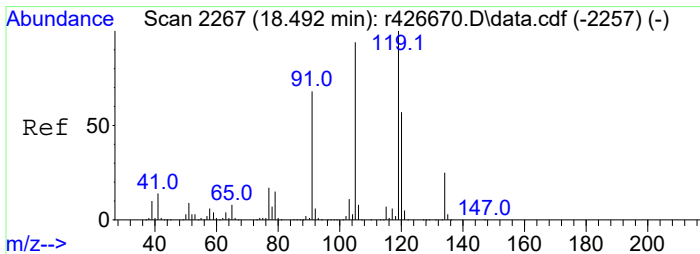
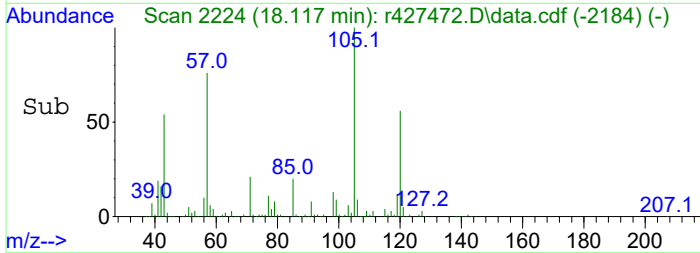
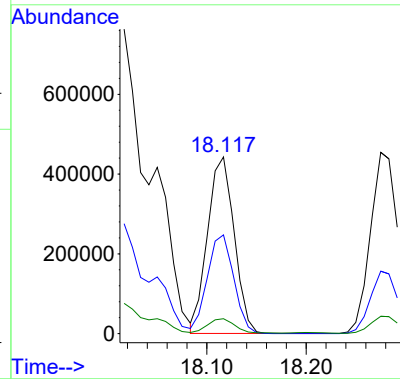
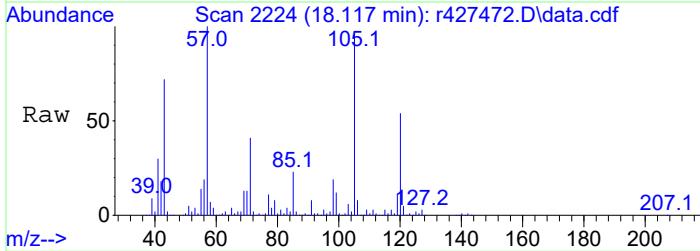

#21  
 1,2,4-Trimethylbenzene  
 Concen: 30.49 ppbV  
 RT: 18.467 min Scan# 2264  
 Delta R.T. 0.000 min  
 Lab File: r427472.D  
 Acq: 21 Apr 2023 6:24 AM

Tgt Ion	Resp	Lower	Upper
105	100		
120	53.0	42.4	63.6
91	9.2	7.4	11.0

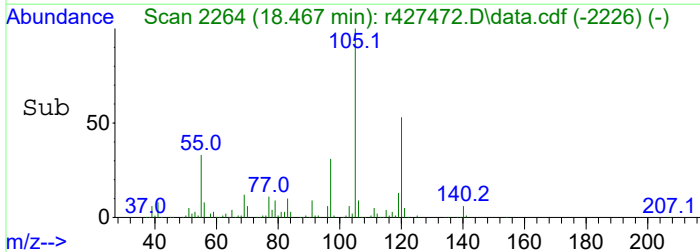
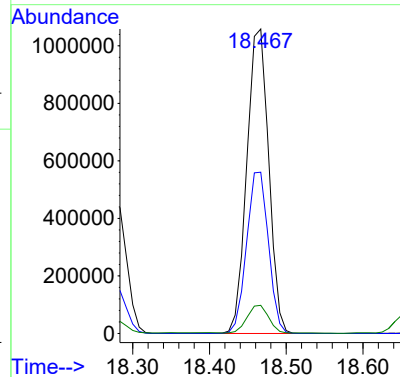
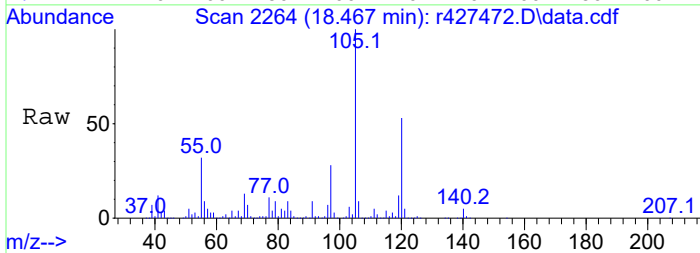

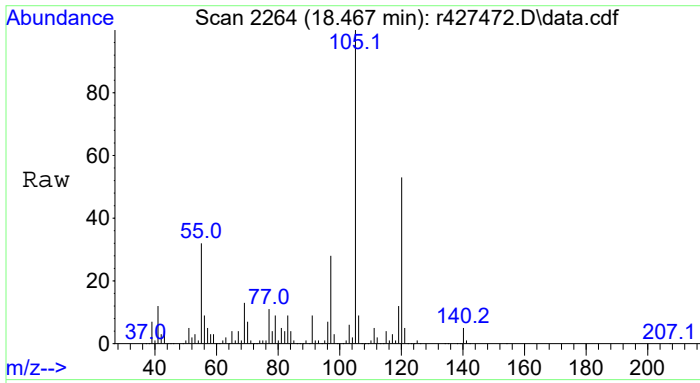

#22  
 C3-Benzenes  
 Concen: 97.13 ppbV m  
 RT: 18.467 min Scan# 2264  
 Delta R.T. 0.000 min  
 Lab File: r427472.D  
 Acq: 21 Apr 2023 6:24 AM

Tgt Ion	Resp	Lower	Upper
105	100		
120	15.1	42.4	63.6#
91	2.5	7.4	11.0#

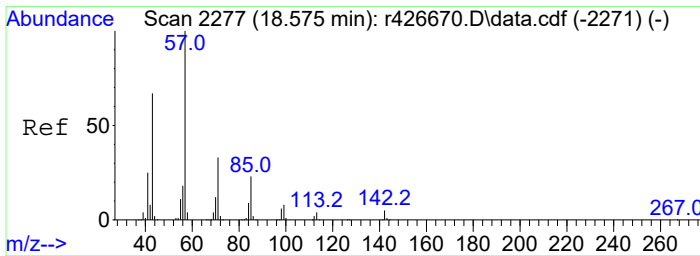
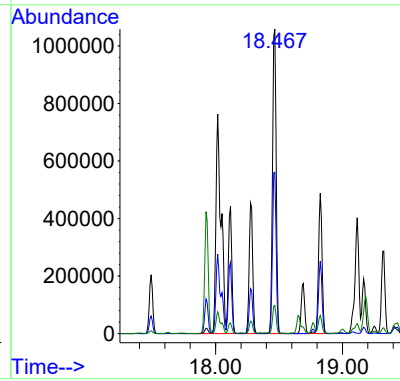
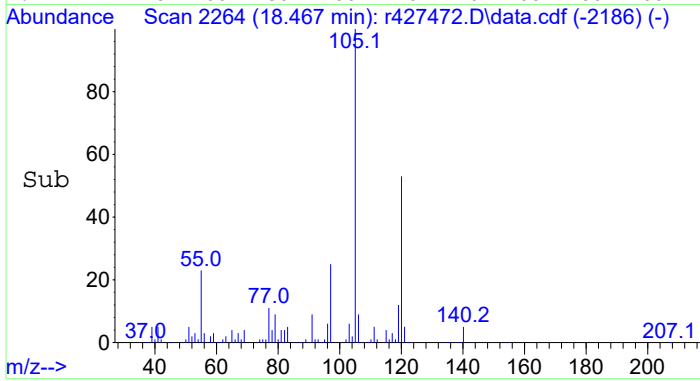

#23  
 decane  
 Concen: 46.97 ppbV  
 RT: 18.542 min Scan# 2273  
 Delta R.T. 0.000 min  
 Lab File: r427472.D  
 Acq: 21 Apr 2023 6:24 AM

Tgt Ion	Resp	Lower	Upper
57	100		
43	82.2	65.8	98.6
142	6.0	4.8	7.2

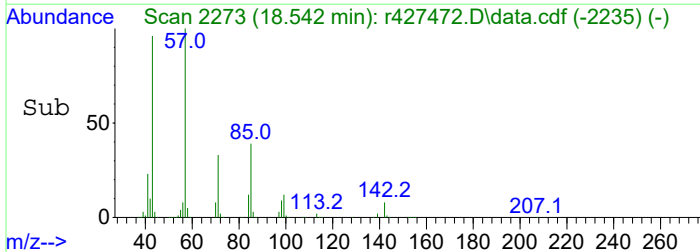
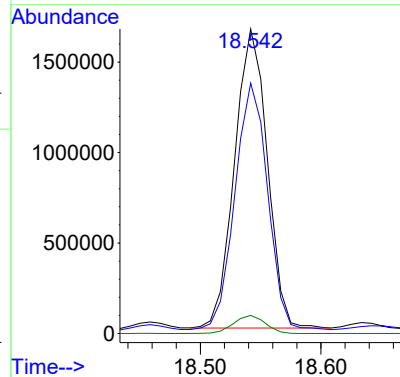
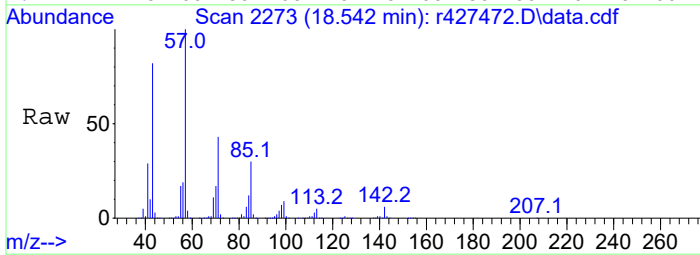

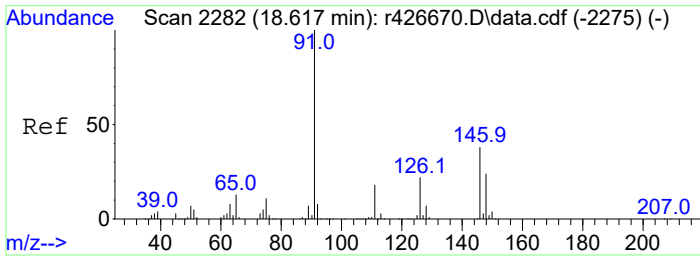

#24  
 C10 - < C11 Aliphatics  
 Concen: 1222.02 ppbV m  
 RT: 18.542 min Scan# 2273  
 Delta R.T. 0.000 min  
 Lab File: r427472.D  
 Acq: 21 Apr 2023 6:24 AM

Tgt Ion:TIC Resp:81223347  
 Ion Ratio Lower Upper  
 TIC 100  
 126 273200.0 2.9 4.3#

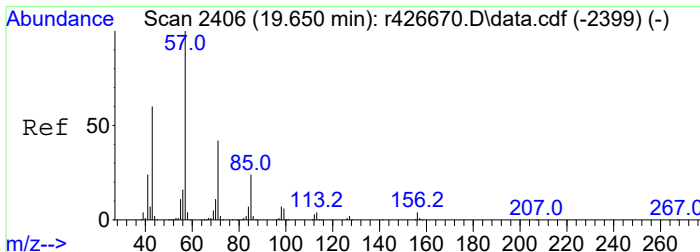
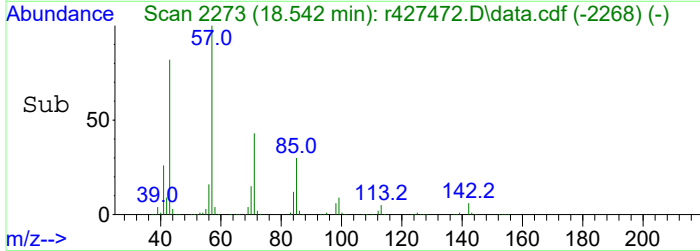
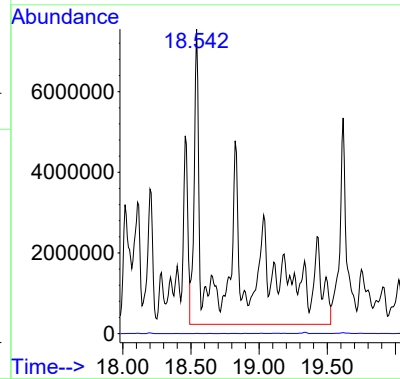
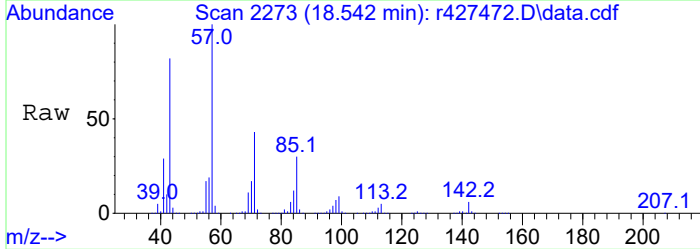

#25  
 undecane  
 Concen: 32.05 ppbV  
 RT: 19.617 min Scan# 2402  
 Delta R.T. 0.000 min  
 Lab File: r427472.D  
 Acq: 21 Apr 2023 6:24 AM

Tgt Ion: 57 Resp: 2276162  
 Ion Ratio Lower Upper  
 57 100  
 43 73.4 58.7 88.1  
 71 51.4 41.1 61.7  
 156 5.3 4.2 6.4

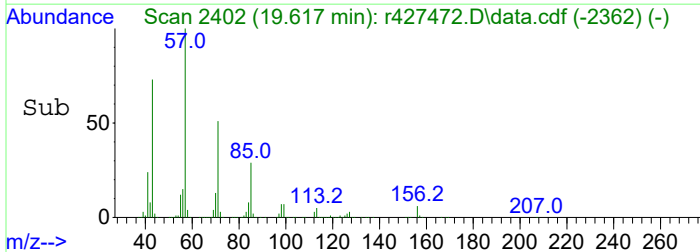
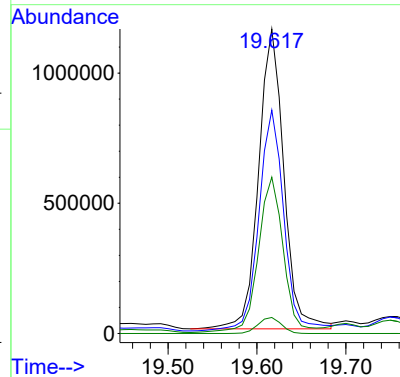
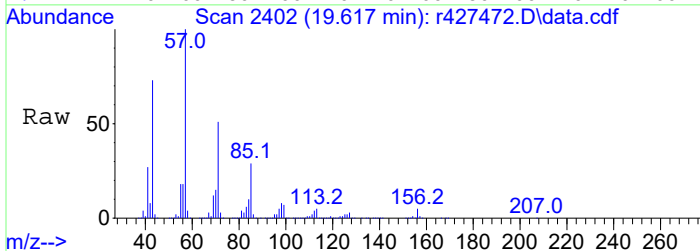

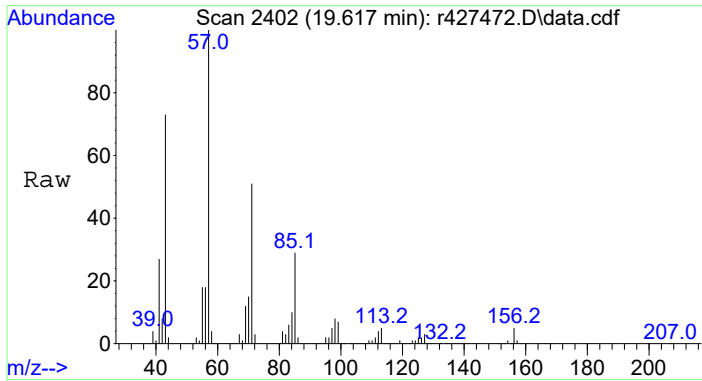

#26  
 C11 - < C12 Aliphatics  
 Concen: 688.97 ppbV m  
 RT: 19.617 min Scan# 2402  
 Delta R.T. 0.000 min  
 Lab File: r427472.D  
 Acq: 21 Apr 2023 6:24 AM  
 Tgt Ion:TIC Resp:48932549

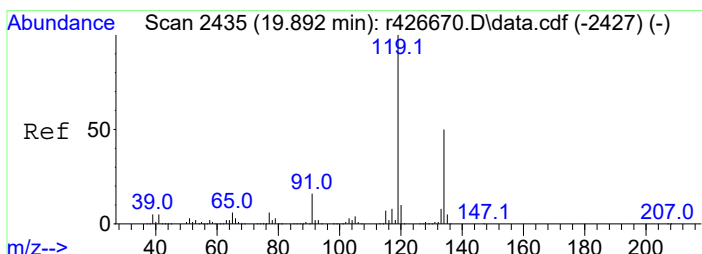
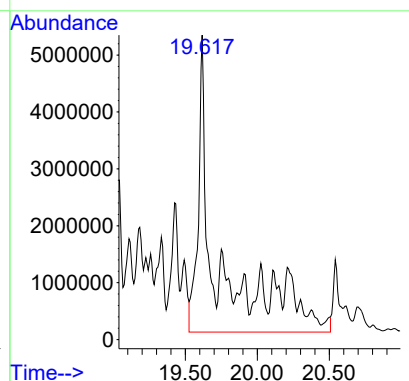
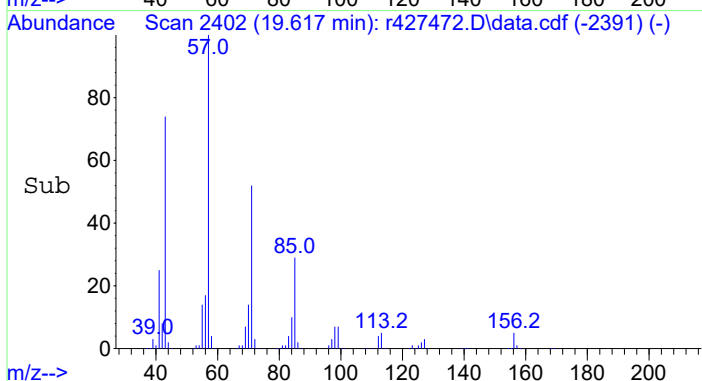

#27  
 1,2,4,5-tetramethylbenzene  
 Concen: 6.53 ppbV  
 RT: 19.892 min Scan# 2435  
 Delta R.T. 0.000 min  
 Lab File: r427472.D  
 Acq: 21 Apr 2023 6:24 AM

Tgt Ion:119 Resp: 251757

Ion	Ratio	Lower	Upper
119	100		
134	44.0	35.2	52.8
91	22.7	18.2	27.2

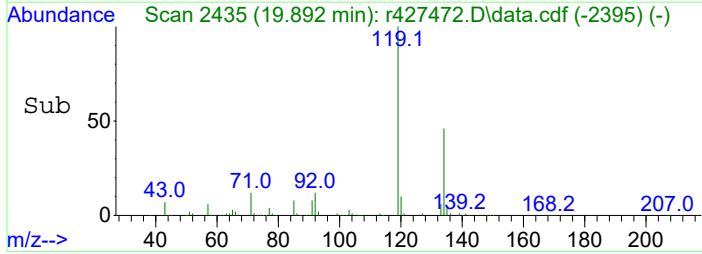
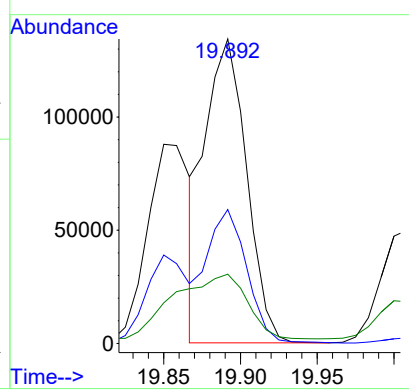
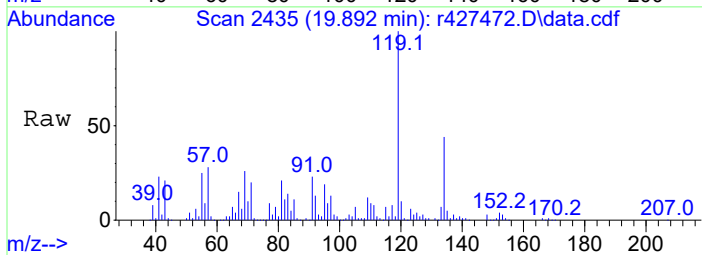

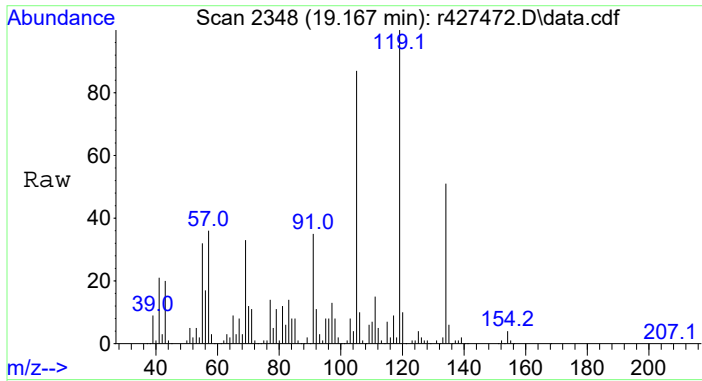

#28  
 C4-Benzenes  
 Concen: 41.18 ppbV m  
 RT: 19.167 min Scan# 2348  
 Delta R.T. 0.000 min  
 Lab File: r427472.D  
 Acq: 21 Apr 2023 6:24 AM

Tgt Ion	Resp	Lower	Upper
134	100		
120	2.5	15.6	23.4#
91	17.2	54.8	82.2#

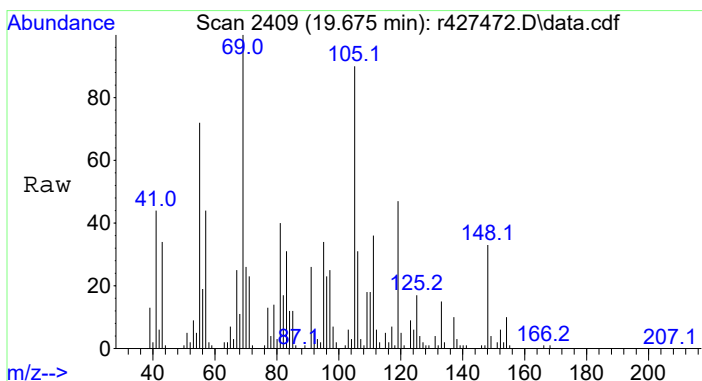
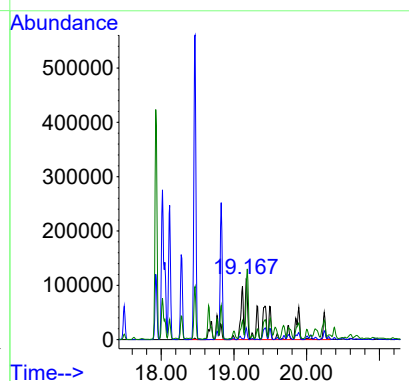
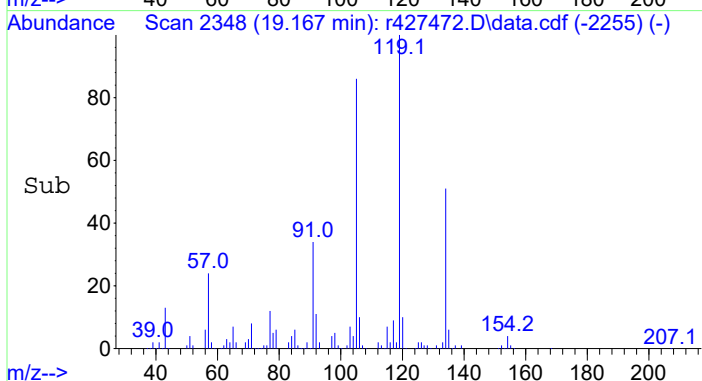

#29  
 C5-Benzenes  
 Concen: 11.86 ppbV m  
 RT: 19.675 min Scan# 2409  
 Delta R.T. 0.000 min  
 Lab File: r427472.D  
 Acq: 21 Apr 2023 6:24 AM

Tgt Ion	Resp	Lower	Upper
148	100		
134	0.9	3.8	5.8#
91	14.7	62.6	94.0#

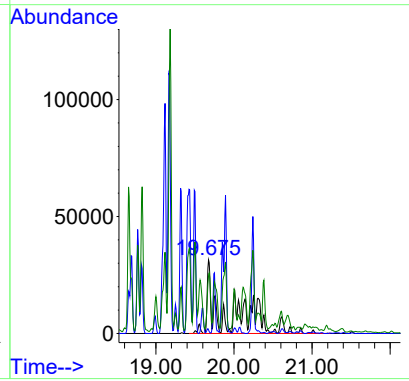
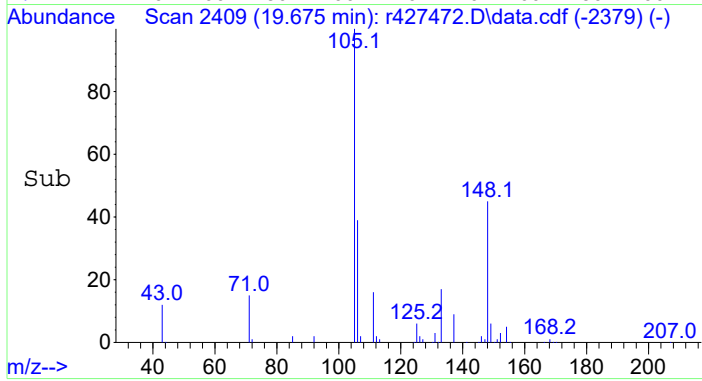



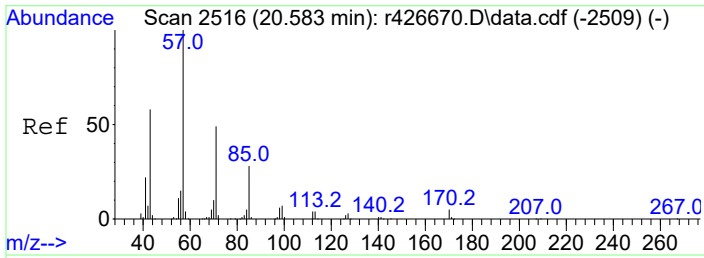

#30  
 dodecane  
 Concen: 8.03 ppbV  
 RT: 20.542 min Scan# 2511  
 Delta R.T. 0.000 min  
 Lab File: r427472.D  
 Acq: 21 Apr 2023 6:24 AM

Tgt Ion: 57 Resp: 530275  
 Ion Ratio Lower Upper  
 57 100  
 43 65.6 52.5 78.7

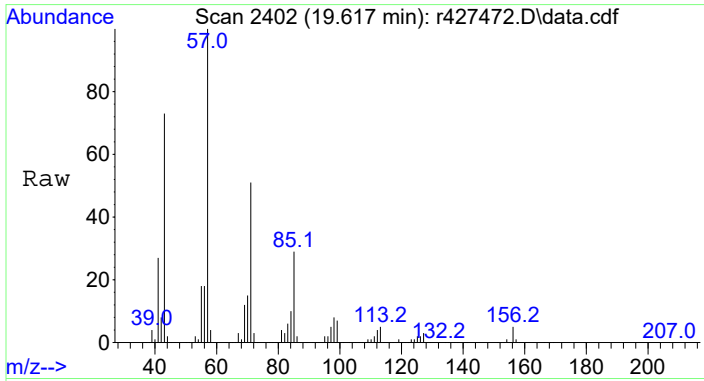
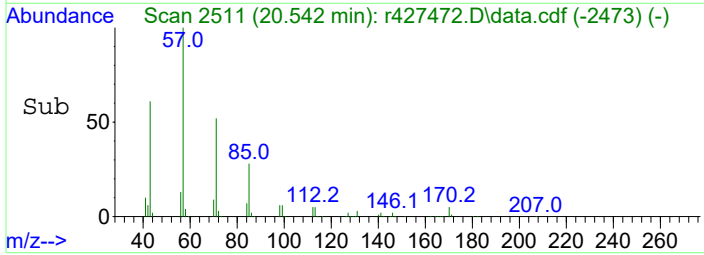
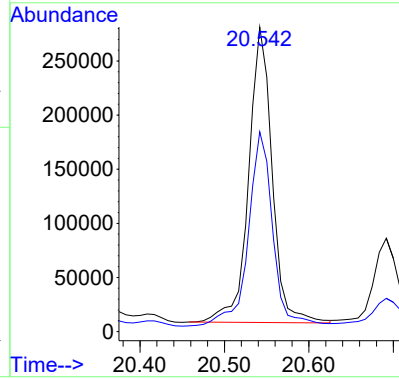
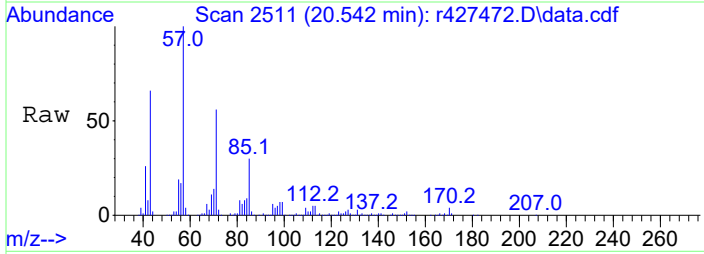

#31  
 C12 + Aliphatics  
 Concen: 1108.02 ppbV m  
 RT: 19.617 min Scan# 2402  
 Delta R.T. 0.000 min  
 Lab File: r427472.D  
 Acq: 21 Apr 2023 6:24 AM

Tgt Ion:TIC Resp:73132420

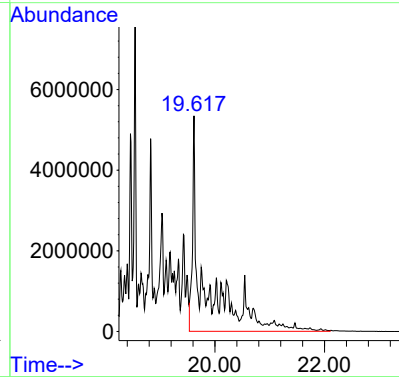
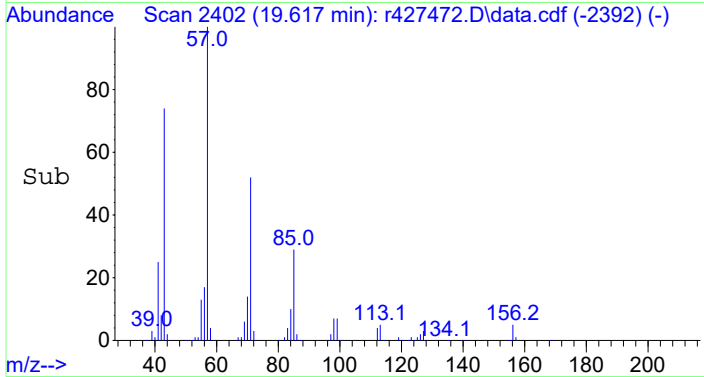

Data Path : C:\PROJECTS\HAWAII DOH\2. LABORATORY DATA\ALPHA\WAF STUDY\L2317092\TO15-LL\NF TO-15\  
 Data File : r427474.D  
 Acq On : 21 Apr 2023 7:43 AM  
 Operator : AIRPIANO4:RAY  
 Sample : L2317092-02D,3,0.98,250  
 Misc : WG1769204,ICAL19932  
 ALS Vial : 0 Sample Multiplier: 1

Quant Time: Jul 28 15:08:12 2023  
 Quant Method : C:\Projects\Hawaii DOH\2. Laboratory Data\Alpha\WAF Study\L2317092\TO15-LL\NF TO-15\TFS19 230501 NF.M  
 Quant Title : TO-14A/TO-15 SIM/Full Scan Analysis  
 QLast Update : Fri Jul 28 14:28:27 2023  
 Response via : Initial Calibration

Compound	R.T.	QIon	Response	Conc	Units	Dev (Min)
Internal Standards						
1) bromochloromethane	9.117	49	297625	10.00	ppbV	0.00
4) 1,4-difluorobenzene	11.313	114	927732	10.00	ppbV	0.00
11) chlorobenzene-D5	16.008	54	133314	10.00	ppbV	0.00

Target Compounds	R.T.	QIon	Response	Conc	Units	Qvalue
2) pentane	6.300	43	335169	14.85	ppbV	100
3) C5 - < C6 Aliphatics	6.300	TIC	4168138m	184.69	ppbV	
5) hexane	9.183	57	358361	11.99	ppbV	99
6) C6 - < C7 Aliphatics	11.313	TIC	13398865m	448.17	ppbV	
7) benzene	10.900	78	211400	3.76	ppbV	100
8) C1 - Benzenes	10.900	78	211400	3.76	ppbV	100
9) heptane	12.473	43	676815	18.39	ppbV	100
10) C7 - C8 Aliphatics	15.275	TIC	46388889m	1260.23	ppbV	
12) toluene	14.258	91	1671900	28.08	ppbV	99
13) octane	15.275	85	1050782	38.62	ppbV	99
14) ethylbenzene	16.400	91	1115469	14.95	ppbV	100
15) m+p-xylene	16.558	91	3084684	50.47	ppbV	100
16) o-xylene	16.983	91	1558628	25.68	ppbV	99
17) C2-Benzenes	16.558	91	5775656m	95.17	ppbV	
18) nonane	17.183	43	2842626	51.17	ppbV	100
19) C9 - < C10 Aliphatics	17.183	TIC	117276565m	2111.08	ppbV	
20) 1,3,5-trimethylbenzene	18.117	105	849691	10.71	ppbV	99
21) 1,2,4-Trimethylbenzene	18.467	105	2401766	32.17	ppbV	98
22) C3-Benzenes	18.467	105	7654194m	102.53	ppbV	
23) decane	18.550	57	3229386	49.31	ppbV	99
24) C10 - < C11 Aliphatics	18.550	TIC	86821012m	1325.80	ppbV	
25) undecane	19.617	57	2408994	34.43	ppbV	100
26) C11 - < C12 Aliphatics	19.608	TIC	52456878m	749.65	ppbV	
27) 1,2,4,5-tetramethylben...	19.883	119	275833m	7.26	ppbV	
28) C4-Benzenes	19.175	134	1753811m	46.17	ppbV	
29) C5-Benzenes	19.675	148	494072m	13.01	ppbV	
30) dodecane	20.525	57	596900	9.18	ppbV	99
31) C12 + Aliphatics	19.608	TIC	78702183m	1210.26	ppbV	

(#) = qualifier out of range (m) = manual integration (+) = signals summed

Data Path : C:\PROJECTS\HAWAII DOH\2. LABORATORY DATA\ALPHA\WAF STUDY\L2317092\TO15-LL\NF TO-15\  
Data File : r427474.D  
Acq On : 21 Apr 2023 7:43 AM  
Operator : AIRPIANO4:RAY  
Sample : L2317092-02D,3,0.98,250  
Misc : WG1769204,ICAL19932  
ALS Vial : 0 Sample Multiplier: 1

Quant Time: Jul 28 15:08:12 2023  
Quant Method : C:\Projects\Hawaii DOH\2. Laboratory Data\Alpha\WAF Study\L2317092\TO15-LL\NF TO-15\  
... 5\TFS19 230501 NF.M  
Quant Title : TO-14A/TO-15 SIM/Full Scan Analysis  
QLast Update : Fri Jul 28 14:28:27 2023  
Response via : Initial Calibration

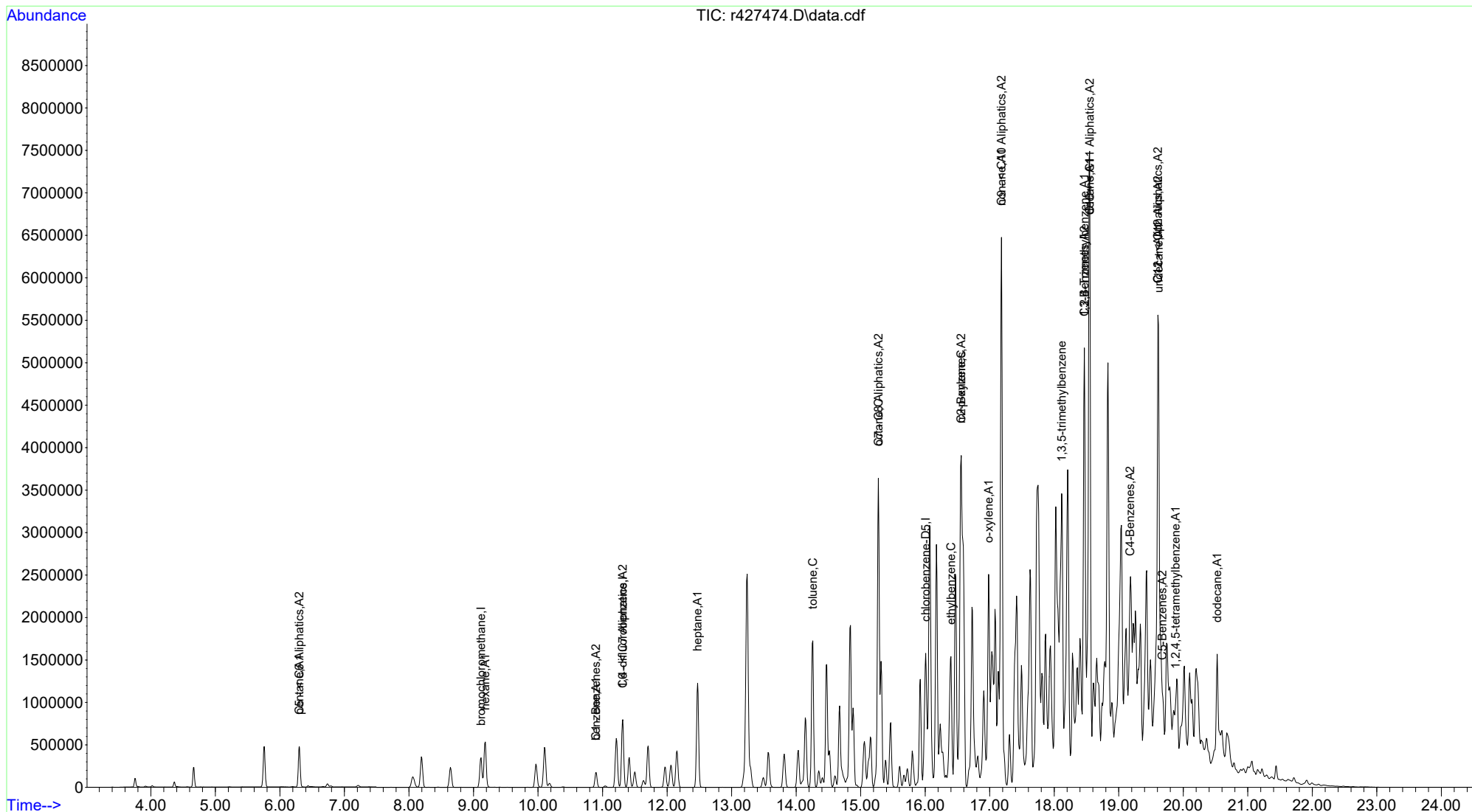

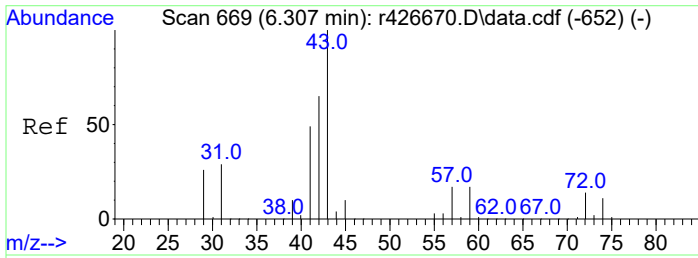

#2  
 pentane  
 Concen: 14.85 ppbV  
 RT: 6.300 min Scan# 667  
 Delta R.T. -0.003 min  
 Lab File: r427474.D  
 Acq: 21 Apr 2023 7:43 AM

Tgt Ion	Resp	Lower	Upper
43	335169		
57	18.6	14.6	22.0
72	13.1	10.5	15.7

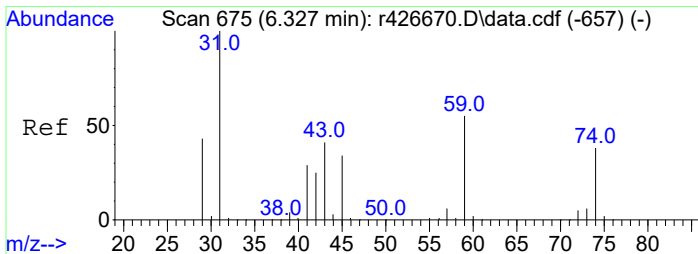
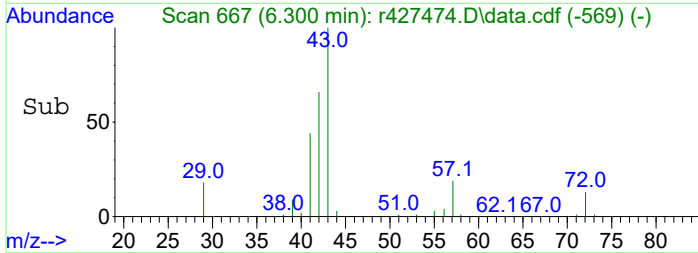
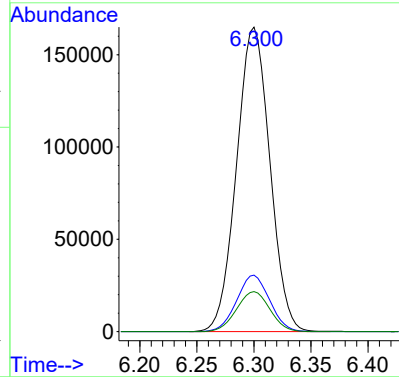
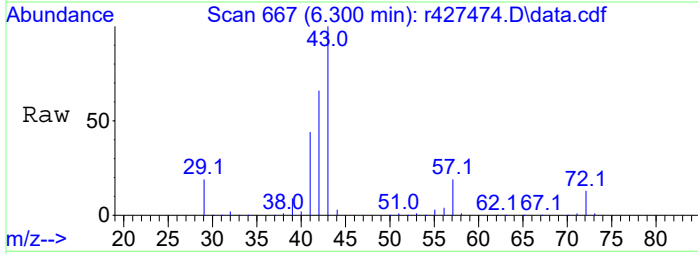

#3  
 C5 - < C6 Aliphatics  
 Concen: 184.69 ppbV m  
 RT: 6.300 min Scan# 667  
 Delta R.T. -0.440 min  
 Lab File: r427474.D  
 Acq: 21 Apr 2023 7:43 AM

Tgt Ion	Resp	Lower	Upper
TIC	4168138		
59	0.0	0.0	0.0
45	0.0	0.0	0.0

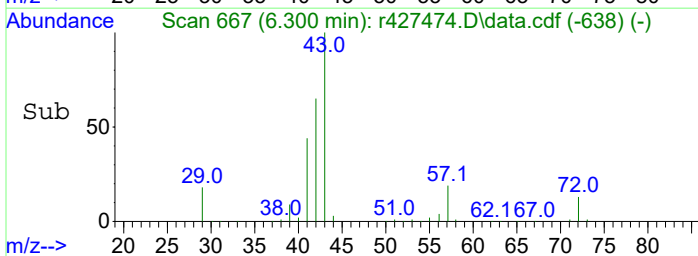
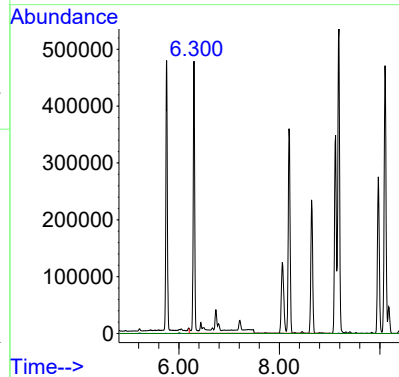
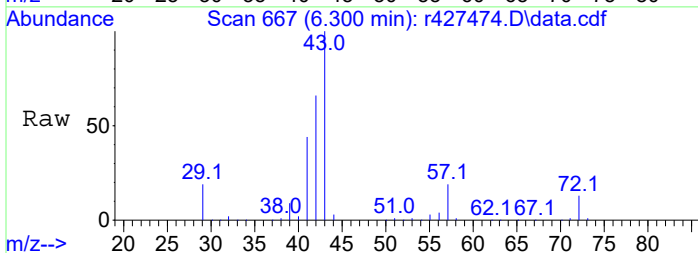

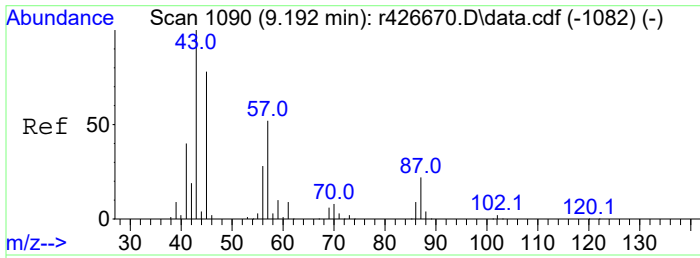

#5  
 hexane  
 Concen: 11.99 ppbV  
 RT: 9.183 min Scan# 1089  
 Delta R.T. 0.000 min  
 Lab File: r427474.D  
 Acq: 21 Apr 2023 7:43 AM

Tgt Ion:	Resp:	Lower	Upper
57	358361		
57	100		
43	57.6	45.7	68.5
86	18.6	15.0	22.6

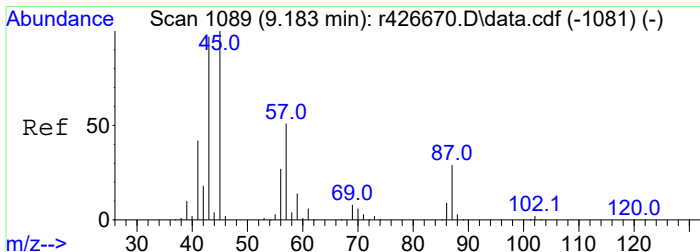
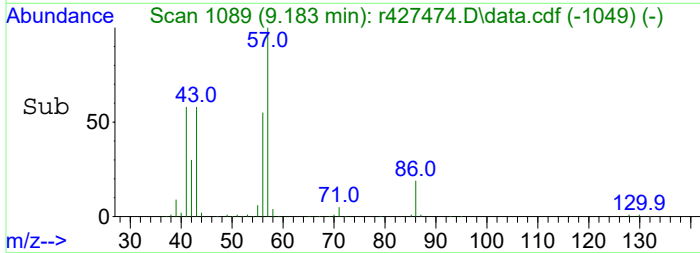
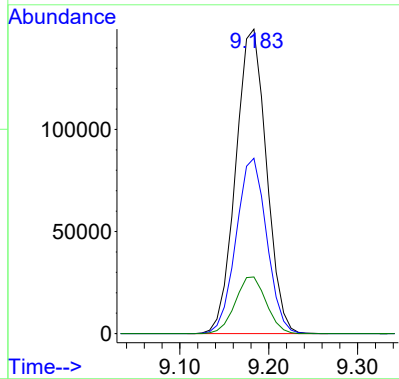
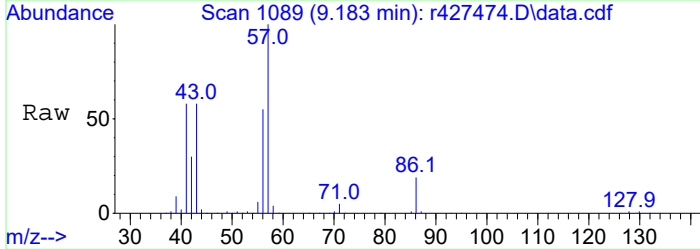

#6  
 C6 - < C7 Aliphatics  
 Concen: 448.17 ppbV m  
 RT: 11.313 min Scan# 1364  
 Delta R.T. 0.000 min  
 Lab File: r427474.D  
 Acq: 21 Apr 2023 7:43 AM

Tgt Ion:	Resp:	Lower	Upper
TIC	13398865		
TIC	100		
59	0.0	0.0	0.0
45	94600.0	9.6	14.4#

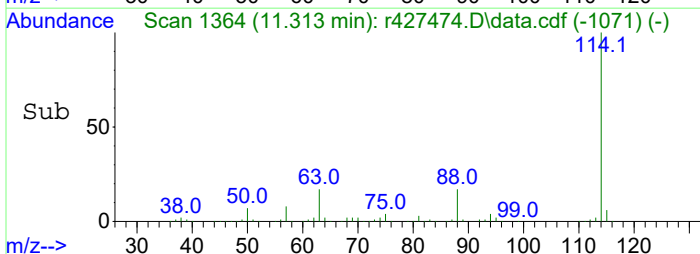
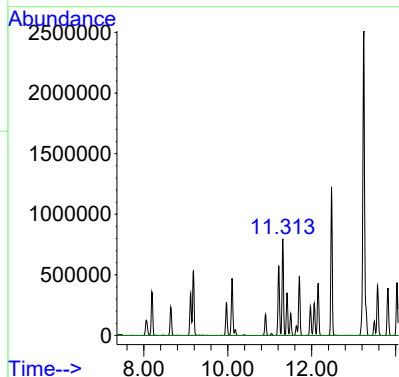
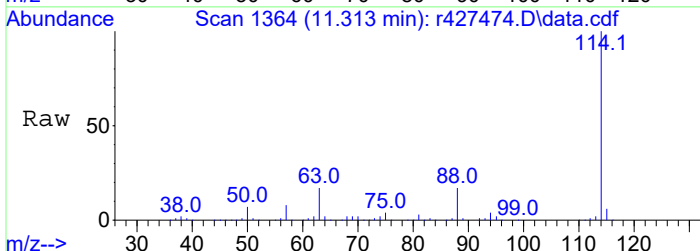

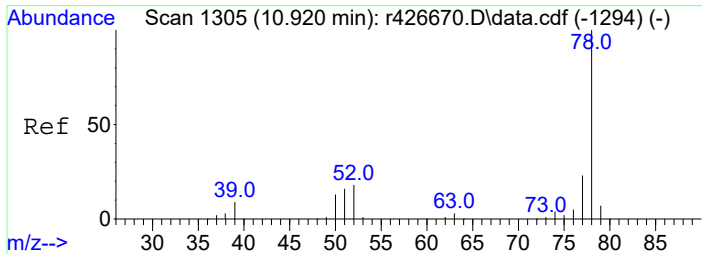

#7  
benzene  
Concen: 3.76 ppbV  
RT: 10.900 min Scan# 1302  
Delta R.T. 0.000 min  
Lab File: r427474.D  
Acq: 21 Apr 2023 7:43 AM

Tgt Ion	Resp	Lower	Upper
78	100		
52	15.8	12.8	19.2

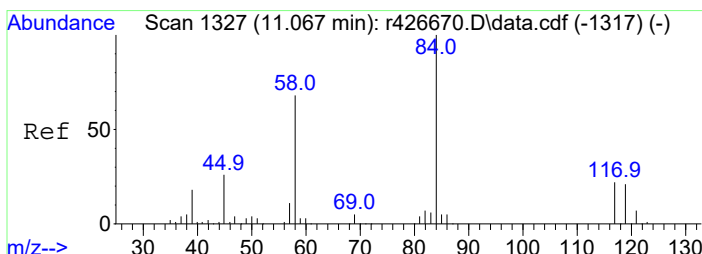
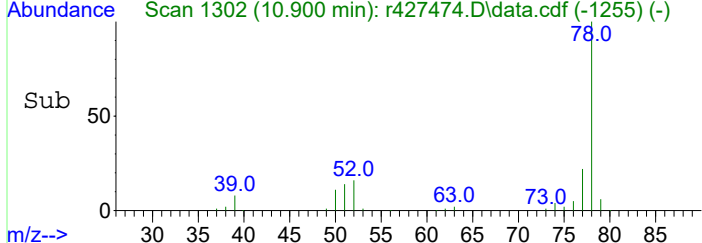
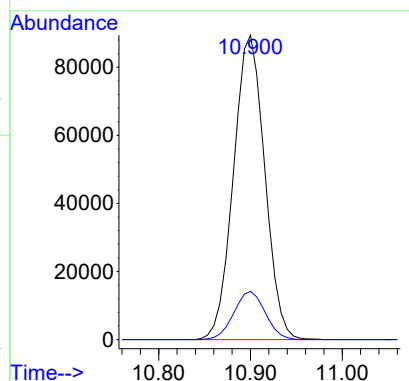
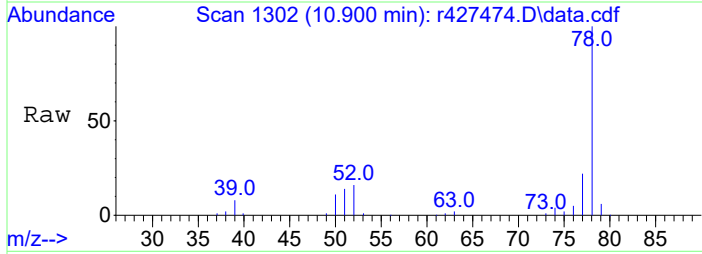

#8  
C1 - Benzenes  
Concen: 3.76 ppbV  
RT: 10.900 min Scan# 1302  
Delta R.T. 0.000 min  
Lab File: r427474.D  
Acq: 21 Apr 2023 7:43 AM

Tgt Ion	Resp	Lower	Upper
78	100		
52	15.8	12.8	19.2

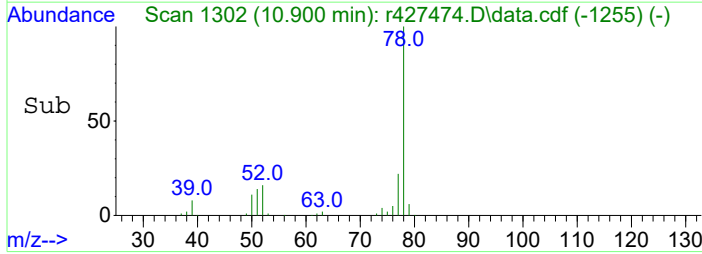
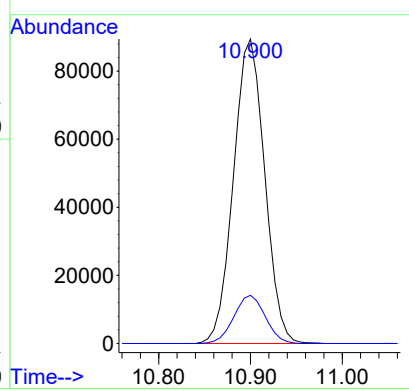
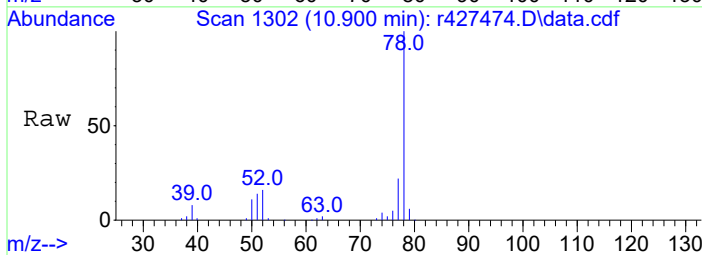

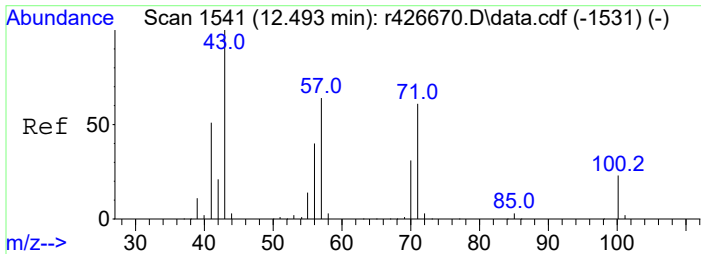

#9  
 heptane  
 Concen: 18.39 ppbV  
 RT: 12.473 min Scan# 1538  
 Delta R.T. 0.000 min  
 Lab File: r427474.D  
 Acq: 21 Apr 2023 7:43 AM

Tgt Ion	Resp	Lower	Upper
43	676815		
57	55.9	44.7	67.1
100	19.7	16.1	24.1

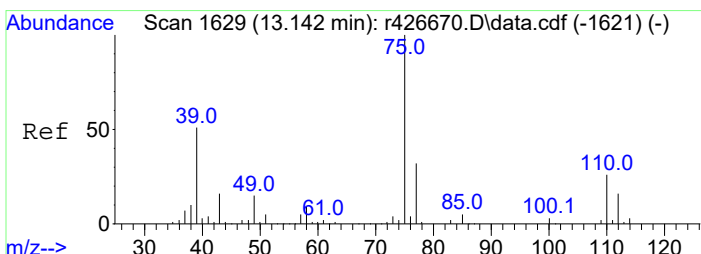
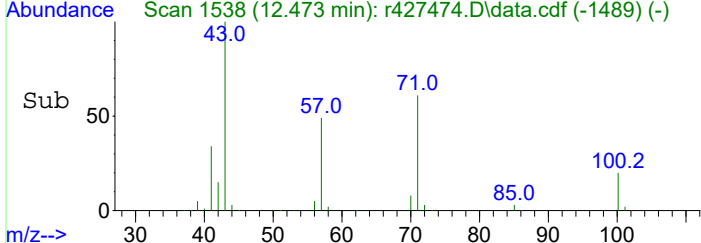
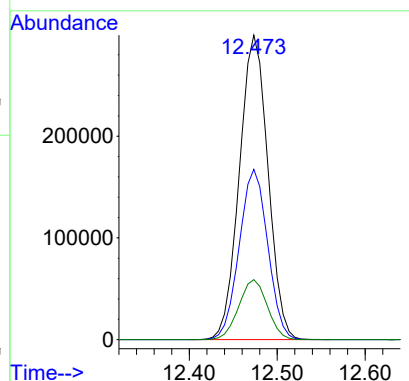
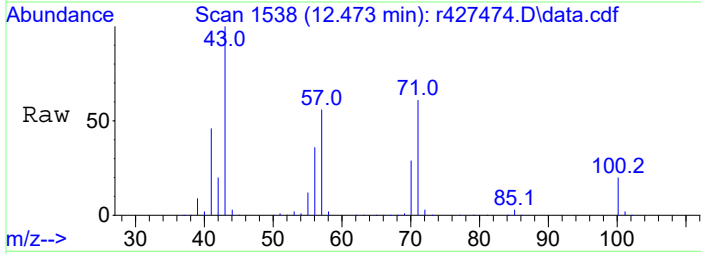

#10  
 C7 - C8 Aliphatics  
 Concen: 1260.23 ppbV m  
 RT: 15.275 min Scan# 1885  
 Delta R.T. 0.000 min  
 Lab File: r427474.D  
 Acq: 21 Apr 2023 7:43 AM

Tgt Ion	Resp	Lower	Upper
TIC	46388889		
39	5878500.0	129.3	193.9#
77	75200.0	1.5	2.3#

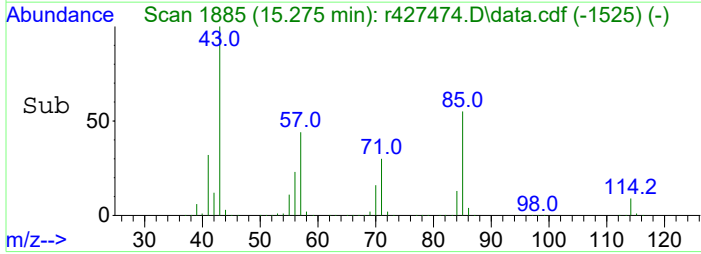
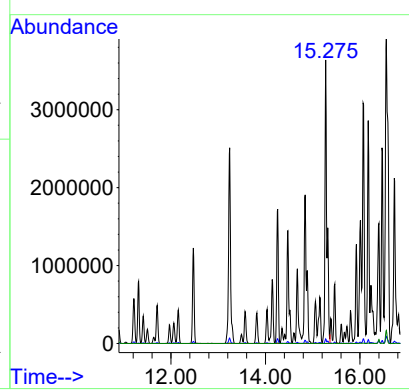
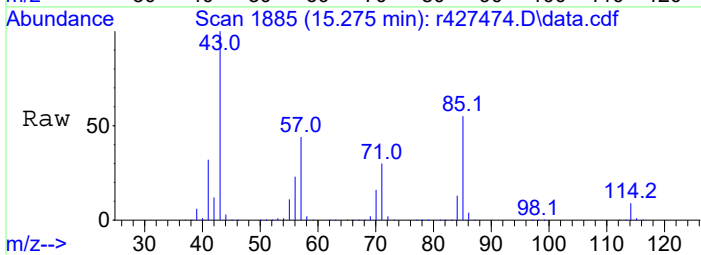

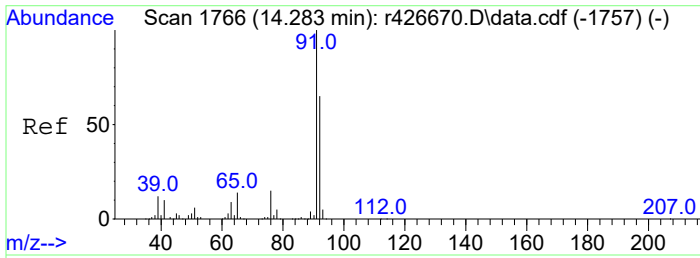

#12  
toluene  
Concen: 28.08 ppbV  
RT: 14.258 min Scan# 1763  
Delta R.T. 0.000 min  
Lab File: r427474.D  
Acq: 21 Apr 2023 7:43 AM

Tgt Ion: 91 Resp: 1671900  
Ion Ratio Lower Upper  
91 100  
92 63.9 51.6 77.4

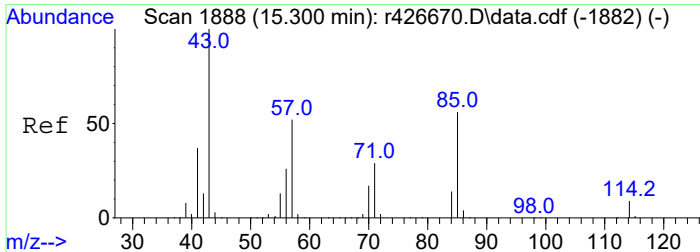
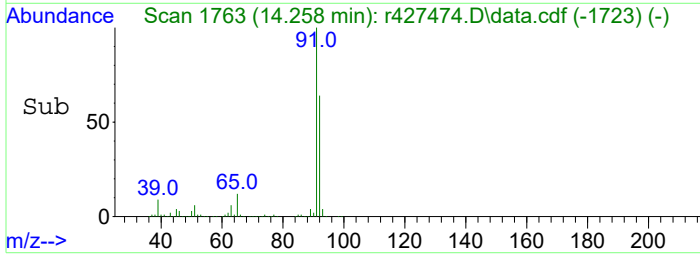
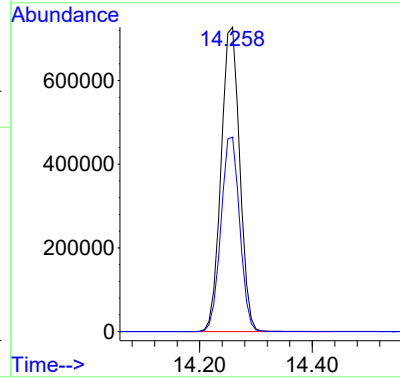
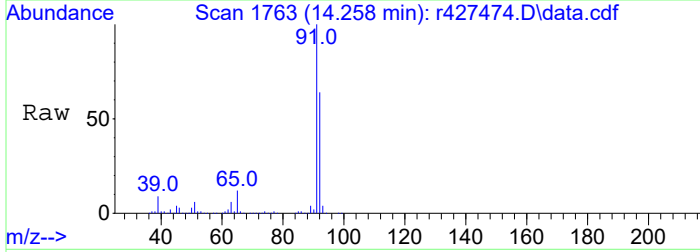

#13  
octane  
Concen: 38.62 ppbV  
RT: 15.275 min Scan# 1885  
Delta R.T. 0.000 min  
Lab File: r427474.D  
Acq: 21 Apr 2023 7:43 AM

Tgt Ion: 85 Resp: 1050782  
Ion Ratio Lower Upper  
85 100  
57 80.2 63.8 95.6  
114 15.6 12.6 18.8  
43 181.6 143.6 215.4

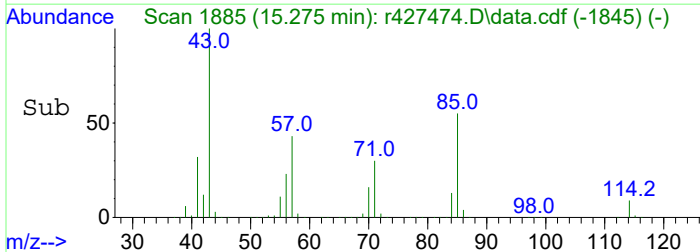
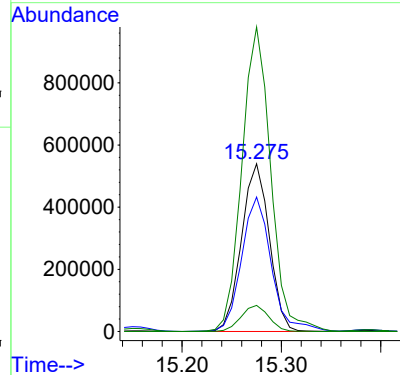
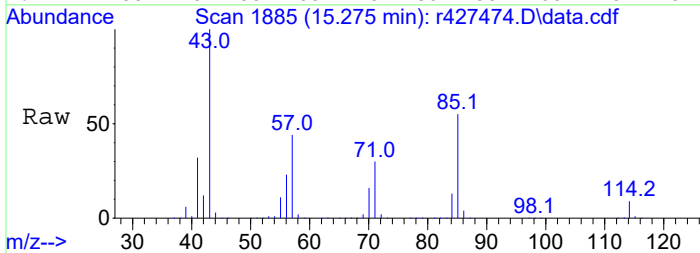



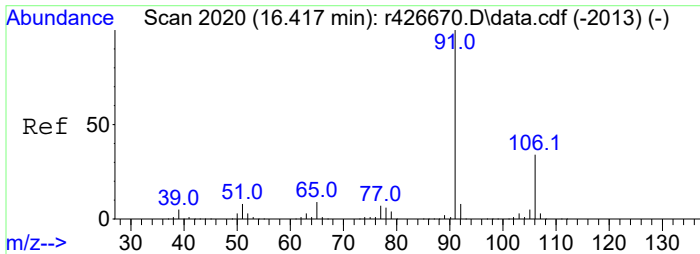

#14  
ethylbenzene  
Concen: 14.95 ppbV  
RT: 16.400 min Scan# 2018  
Delta R.T. 0.008 min  
Lab File: r427474.D  
Acq: 21 Apr 2023 7:43 AM

Tgt Ion: 91 Resp: 1115469  
Ion Ratio Lower Upper  
91 100  
106 39.9 31.8 47.6

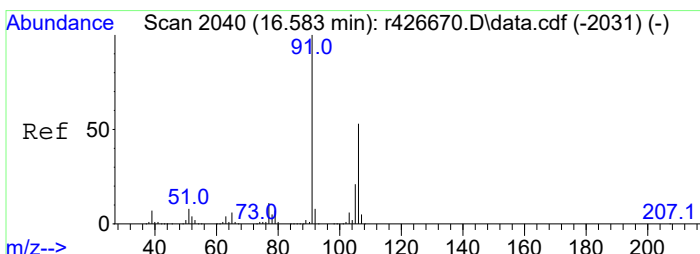
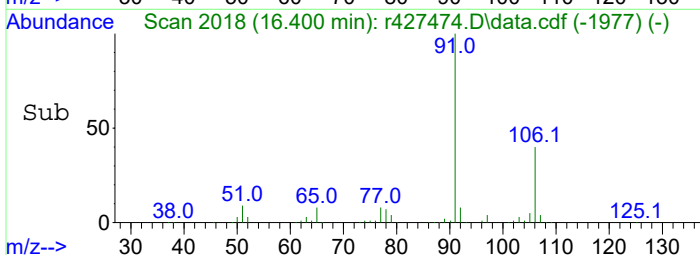
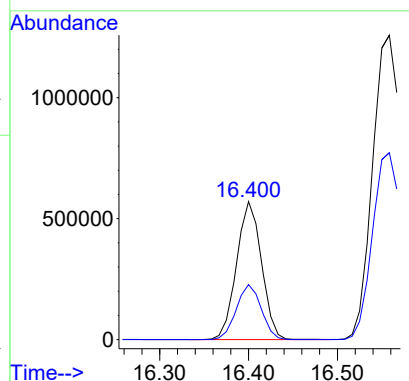
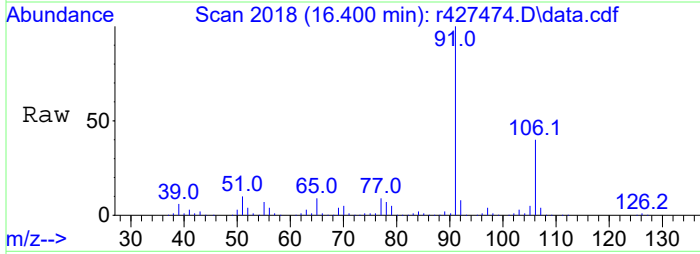

#15  
m+p-xylene  
Concen: 50.47 ppbV  
RT: 16.558 min Scan# 2037  
Delta R.T. 0.008 min  
Lab File: r427474.D  
Acq: 21 Apr 2023 7:43 AM

Tgt Ion: 91 Resp: 3084684  
Ion Ratio Lower Upper  
91 100  
106 61.4 48.8 73.2

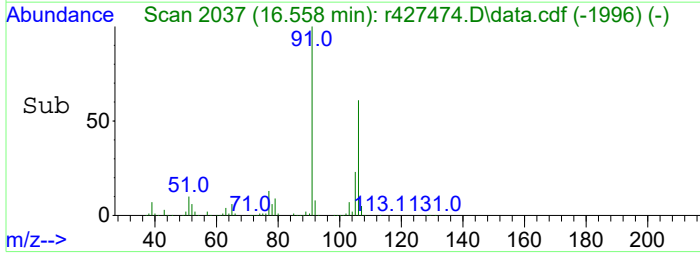
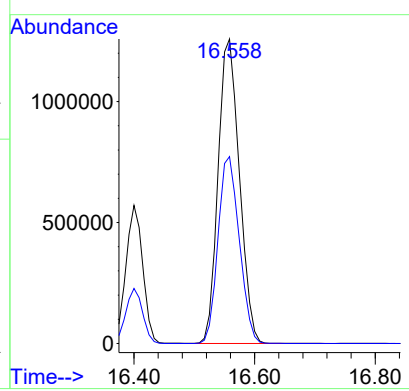
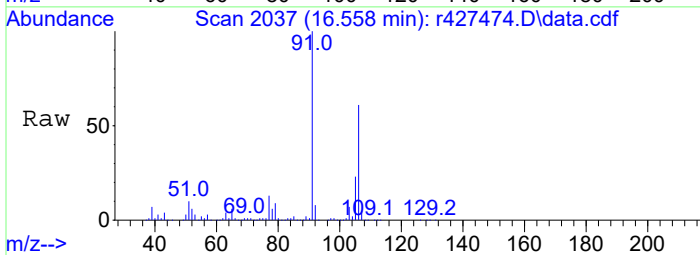

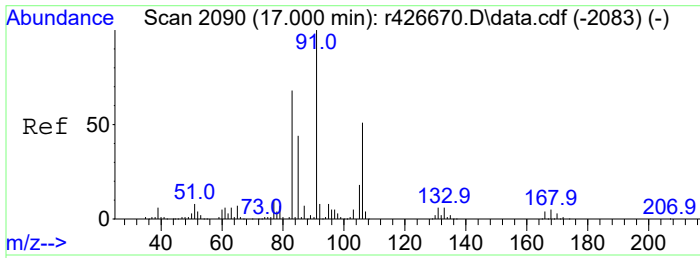

#16  
 o-xylene  
 Concen: 25.68 ppbV  
 RT: 16.983 min Scan# 2088  
 Delta R.T. 0.008 min  
 Lab File: r427474.D  
 Acq: 21 Apr 2023 7:43 AM

Tgt Ion: 91 Resp: 1558628  
 Ion Ratio Lower Upper  
 91 100  
 106 58.0 46.9 70.3

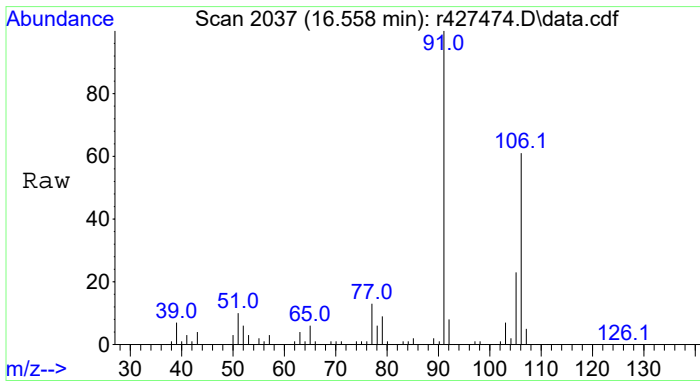
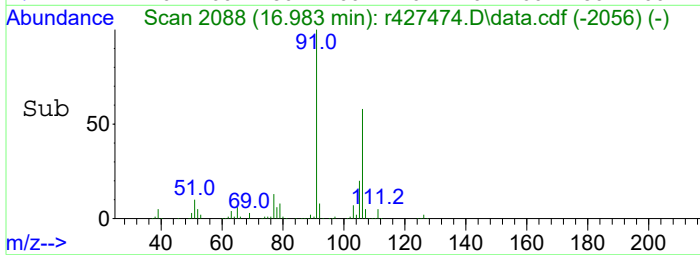
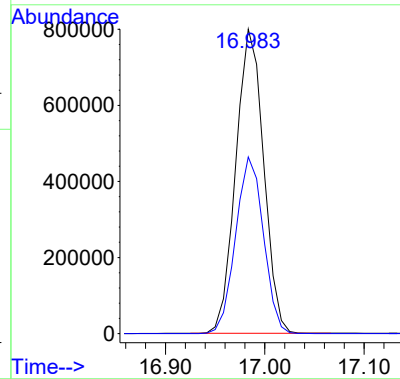
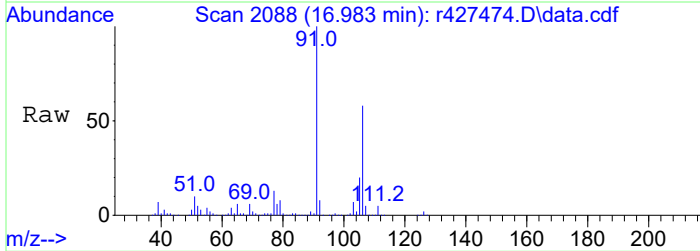

#17  
 C2-Benzenes  
 Concen: 95.17 ppbV m  
 RT: 16.558 min Scan# 2037  
 Delta R.T. 0.008 min  
 Lab File: r427474.D  
 Acq: 21 Apr 2023 7:43 AM

Tgt Ion: 91 Resp: 5775656  
 Ion Ratio Lower Upper  
 91 100  
 106 61.4 48.8 73.2

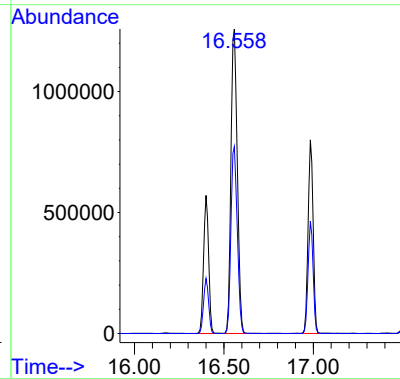
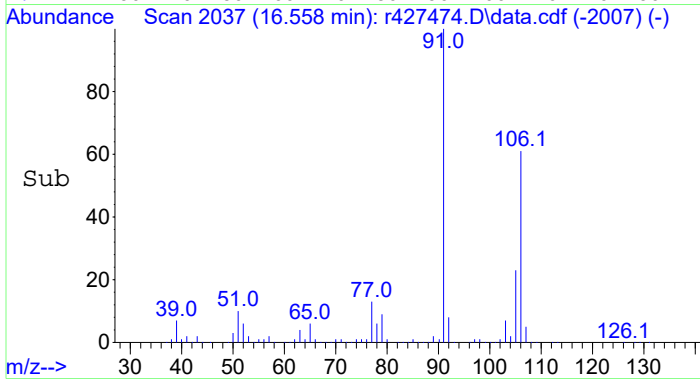

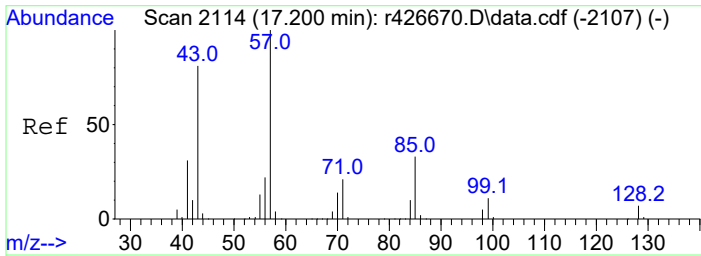

#18  
 nonane  
 Concen: 51.17 ppbV  
 RT: 17.183 min Scan# 2112  
 Delta R.T. 0.008 min  
 Lab File: r427474.D  
 Acq: 21 Apr 2023 7:43 AM

Tgt Ion: 43 Resp: 2842626

Ion	Ratio	Lower	Upper
43	100		
57	99.9	79.7	119.5
128	7.8	6.2	9.2

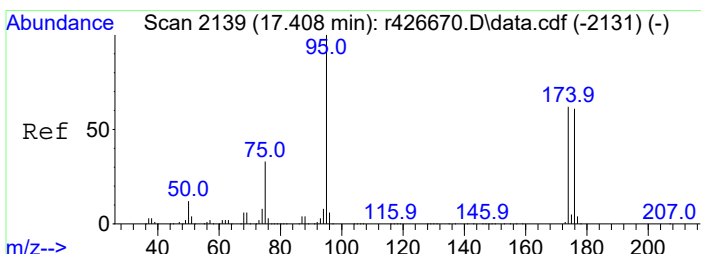
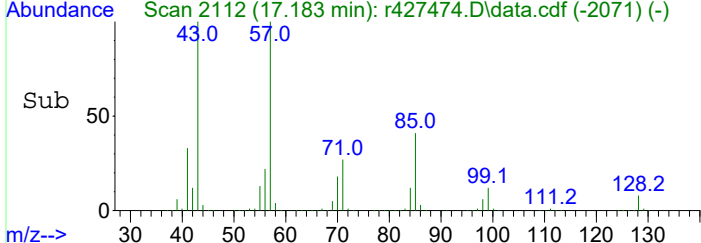
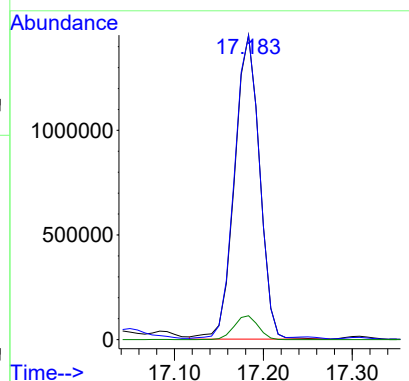
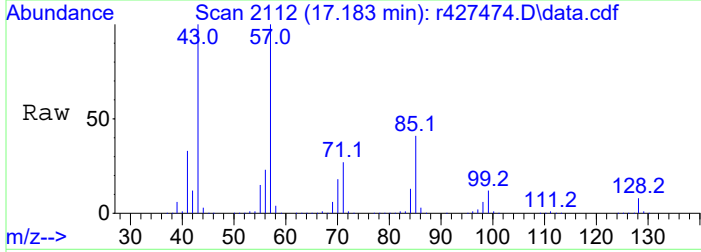

#19  
 C9 - < C10 Aliphatics  
 Concen: 2111.08 ppbV m  
 RT: 17.183 min Scan# 2112  
 Delta R.T. 0.008 min  
 Lab File: r427474.D  
 Acq: 21 Apr 2023 7:43 AM

Tgt Ion:TIC Resp:117276565

Ion	Ratio	Lower	Upper
TIC	100		
174	0.0	0.0	0.0
75	0.0	0.0	0.0

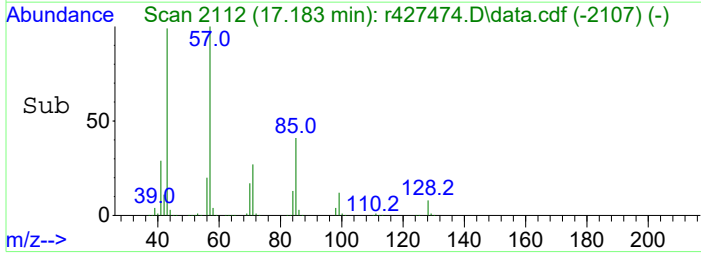
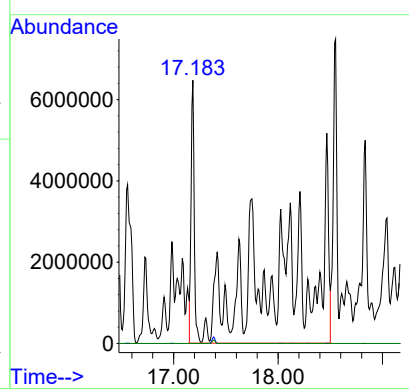
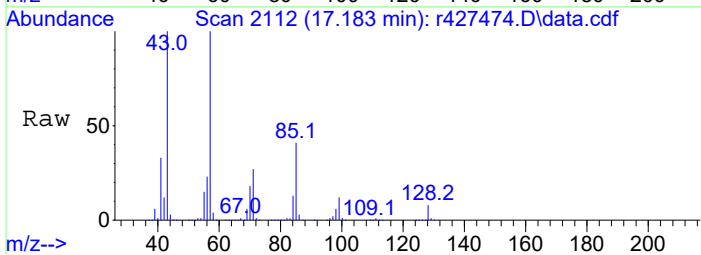

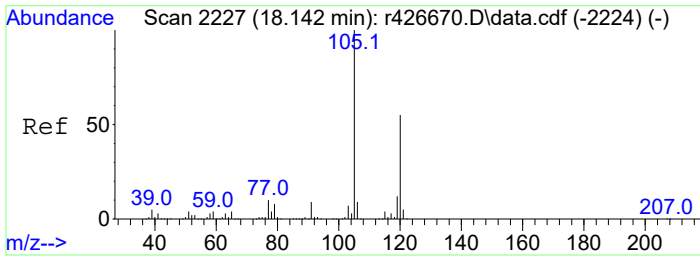

#20  
 1,3,5-trimethylbenzene  
 Concen: 10.71 ppbV  
 RT: 18.117 min Scan# 2224  
 Delta R.T. 0.000 min  
 Lab File: r427474.D  
 Acq: 21 Apr 2023 7:43 AM

Tgt Ion	Resp	Lower	Upper
105	100		
120	56.4	44.6	67.0
91	8.3	6.8	10.2

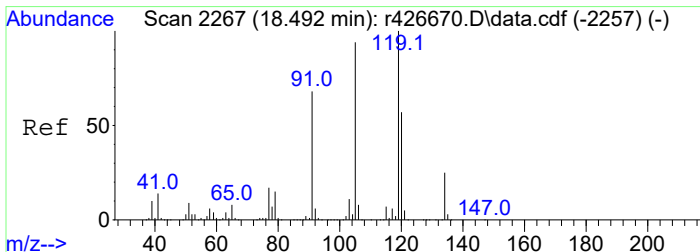
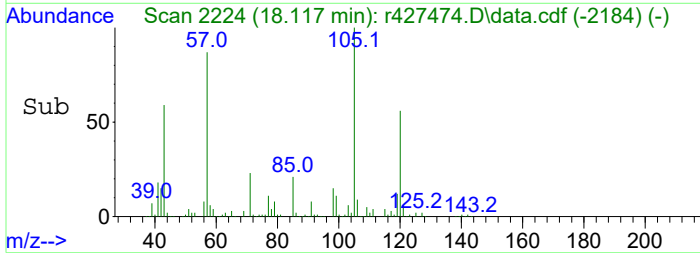
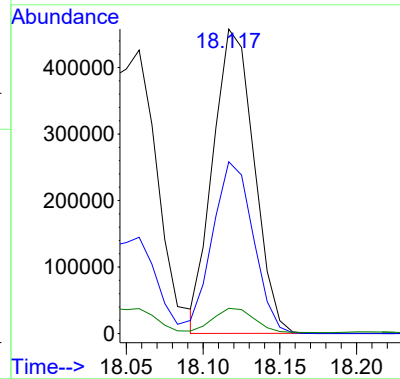
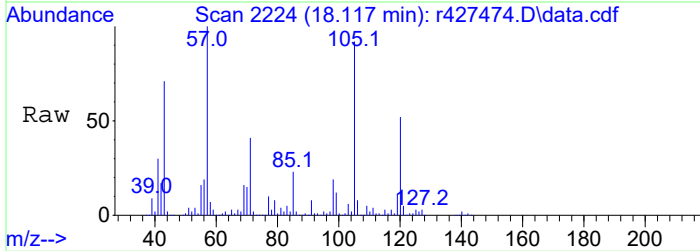

#21  
 1,2,4-Trimethylbenzene  
 Concen: 32.17 ppbV  
 RT: 18.467 min Scan# 2264  
 Delta R.T. 0.000 min  
 Lab File: r427474.D  
 Acq: 21 Apr 2023 7:43 AM

Tgt Ion	Resp	Lower	Upper
105	100		
120	54.5	42.4	63.6
91	9.3	7.4	11.0

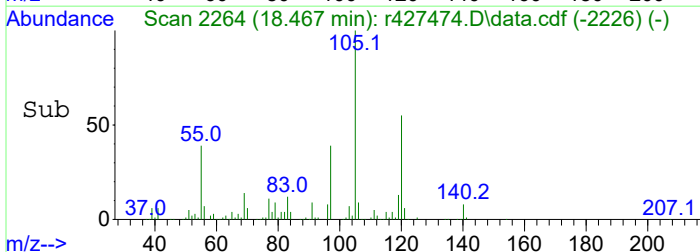
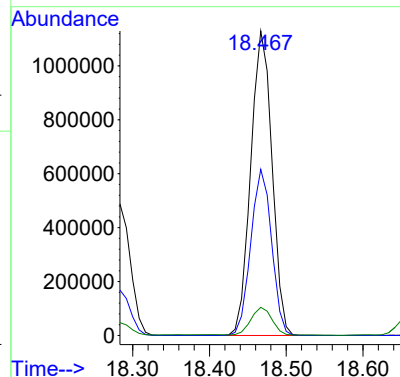
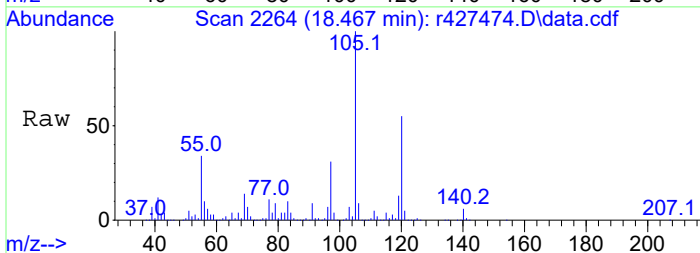

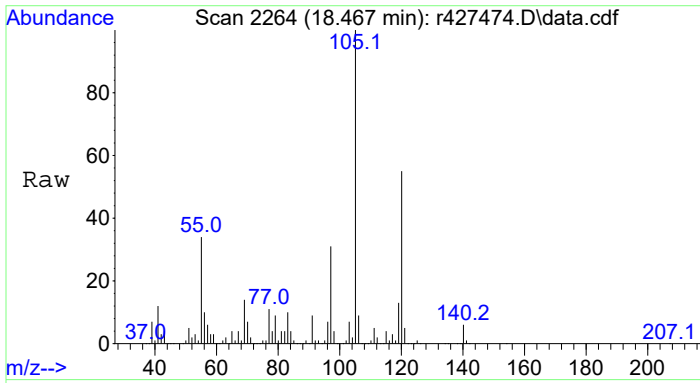

#22  
 C3-Benzenes  
 Concen: 102.53 ppbV m  
 RT: 18.467 min Scan# 2264  
 Delta R.T. 0.000 min  
 Lab File: r427474.D  
 Acq: 21 Apr 2023 7:43 AM

Tgt Ion	Resp	Lower	Upper
105	100		
120	15.2	42.4	63.6#
91	2.6	7.4	11.0#

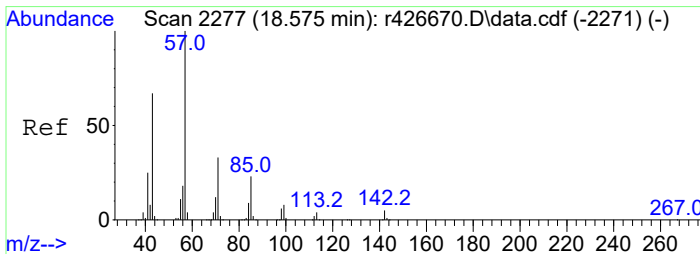
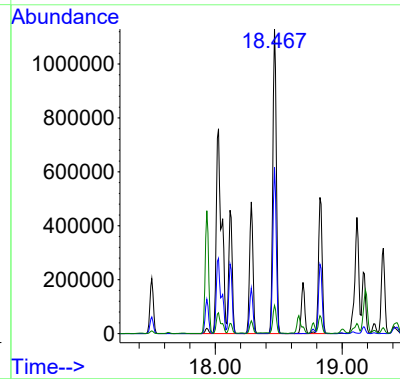
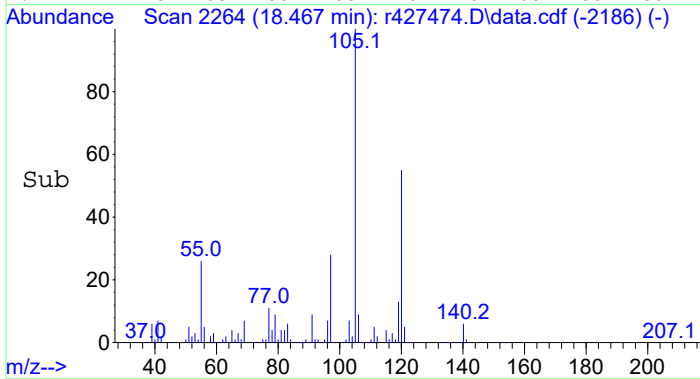

#23  
 decane  
 Concen: 49.31 ppbV  
 RT: 18.550 min Scan# 2274  
 Delta R.T. 0.008 min  
 Lab File: r427474.D  
 Acq: 21 Apr 2023 7:43 AM

Tgt Ion	Resp	Lower	Upper
57	100		
43	83.2	65.8	98.6
142	5.7	4.8	7.2

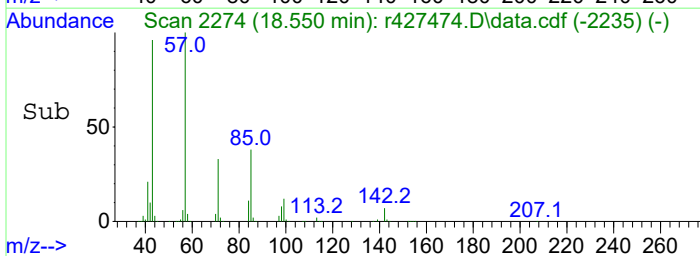
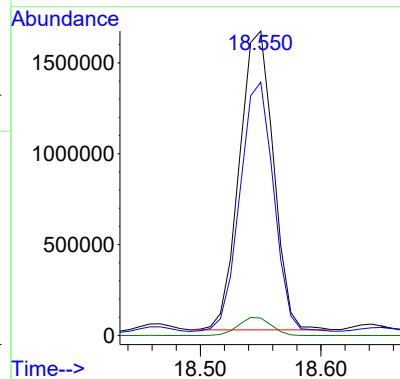
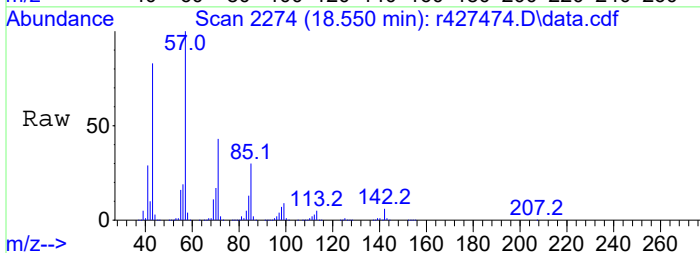

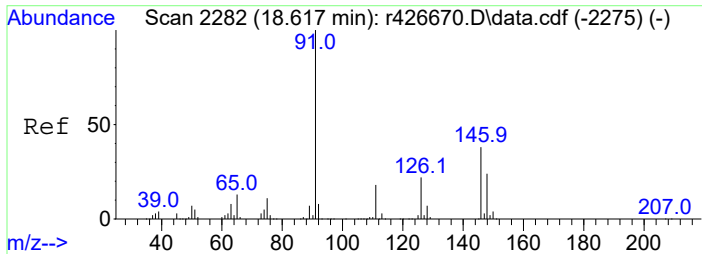

#24  
 C10 - < C11 Aliphatics  
 Concen: 1325.80 ppbV m  
 RT: 18.550 min Scan# 2274  
 Delta R.T. 0.008 min  
 Lab File: r427474.D  
 Acq: 21 Apr 2023 7:43 AM

Tgt Ion:TIC Resp:86821012  
 Ion Ratio Lower Upper  
 TIC 100  
 126 295700.0 2.9 4.3#

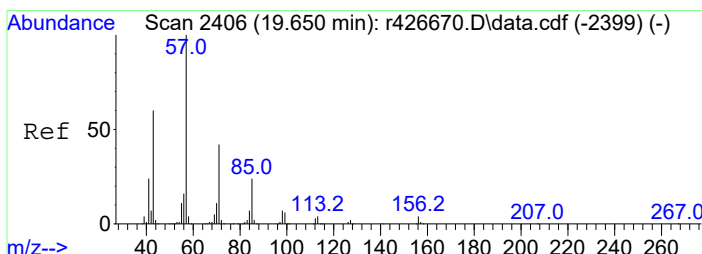
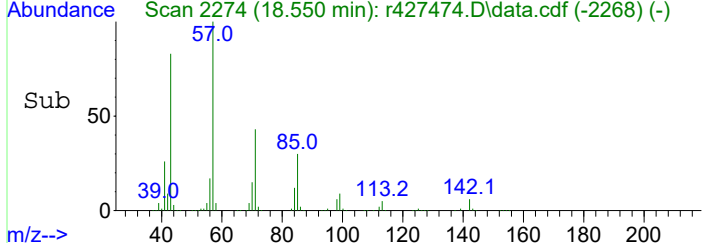
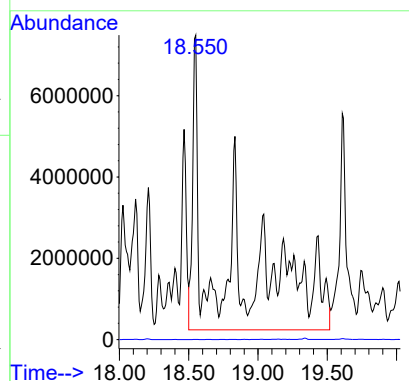
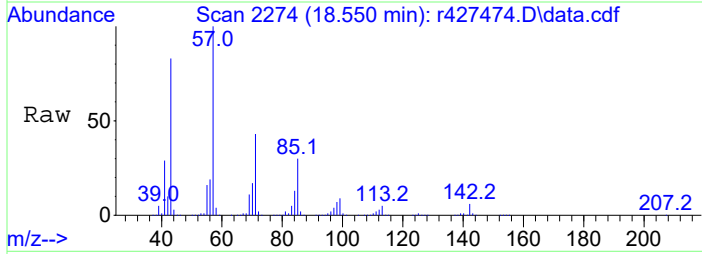

#25  
 undecane  
 Concen: 34.43 ppbV  
 RT: 19.617 min Scan# 2402  
 Delta R.T. 0.000 min  
 Lab File: r427474.D  
 Acq: 21 Apr 2023 7:43 AM

Tgt Ion: 57 Resp: 2408994  
 Ion Ratio Lower Upper  
 57 100  
 43 73.5 58.7 88.1  
 71 51.3 41.1 61.7  
 156 5.1 4.2 6.4

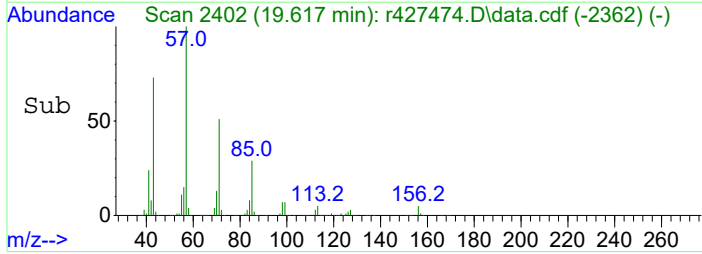
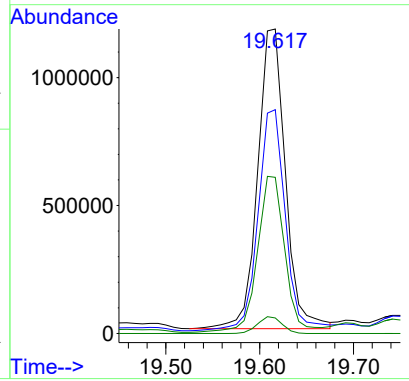
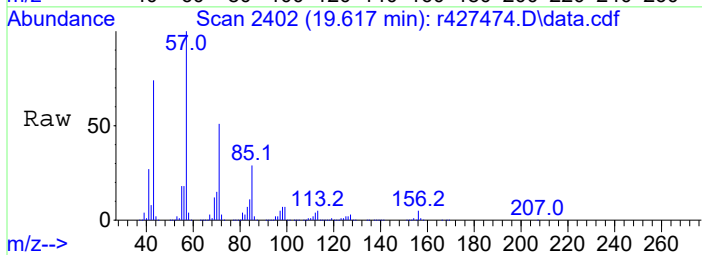

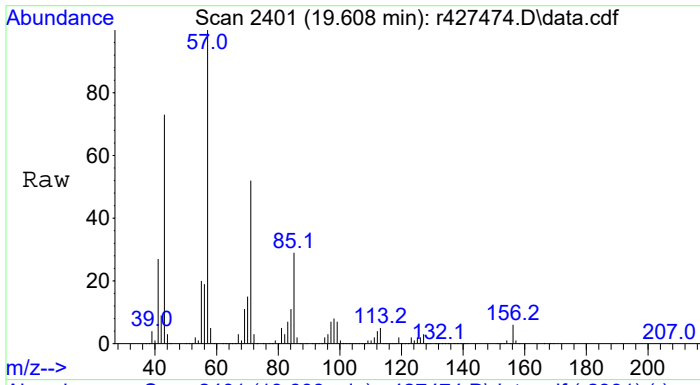

#26  
 C11 - < C12 Aliphatics  
 Concen: 749.65 ppbV m  
 RT: 19.608 min Scan# 2401  
 Delta R.T. -0.008 min  
 Lab File: r427474.D  
 Acq: 21 Apr 2023 7:43 AM  
 Tgt Ion:TIC Resp:52456878

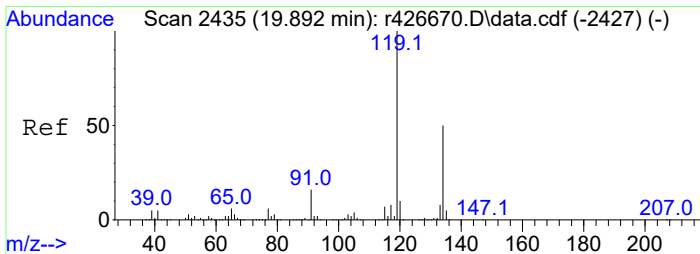
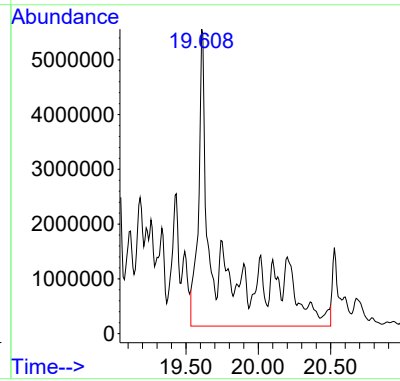
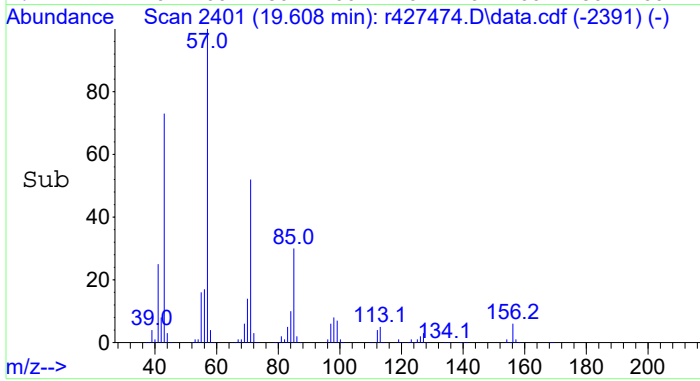

#27  
 1,2,4,5-tetramethylbenzene  
 Concen: 7.26 ppbV m  
 RT: 19.883 min Scan# 2434  
 Delta R.T. -0.008 min  
 Lab File: r427474.D  
 Acq: 21 Apr 2023 7:43 AM

Tgt Ion:119 Resp: 275833

Ion	Ratio	Lower	Upper
119	100		
134	44.5	35.2	52.8
91	22.7	18.2	27.2

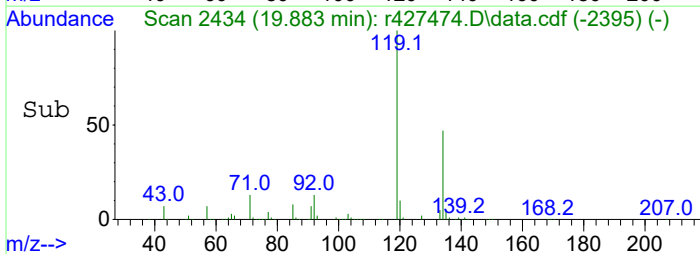
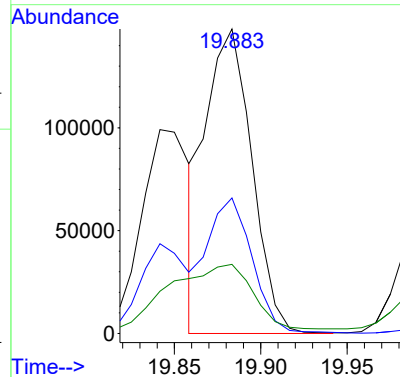
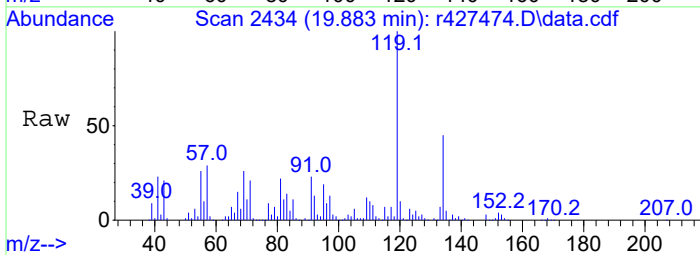

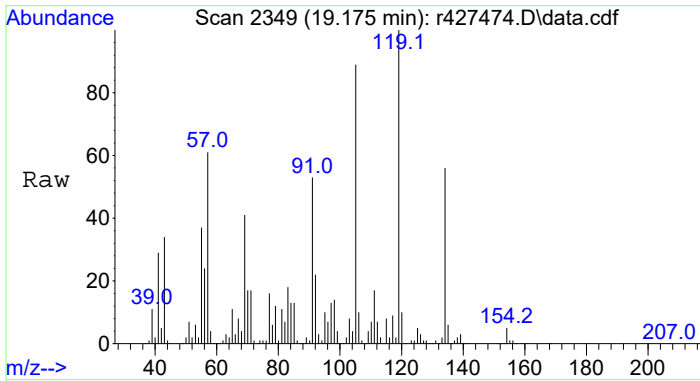

#28  
 C4-Benzenes  
 Concen: 46.17 ppbV m  
 RT: 19.175 min Scan# 2349  
 Delta R.T. 0.008 min  
 Lab File: r427474.D  
 Acq: 21 Apr 2023 7:43 AM

Tgt Ion	Ratio	Lower	Upper
134	100		
120	2.7	15.6	23.4#
91	19.5	54.8	82.2#

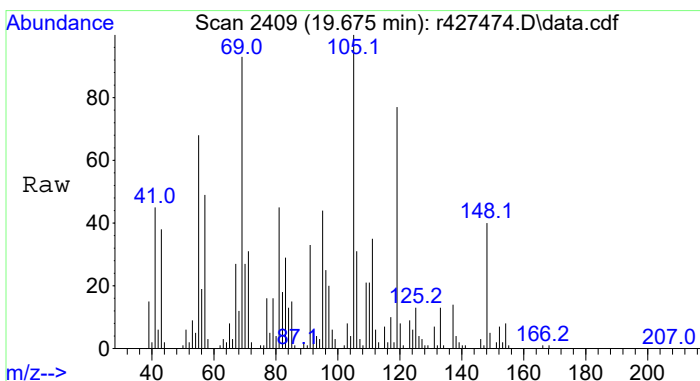
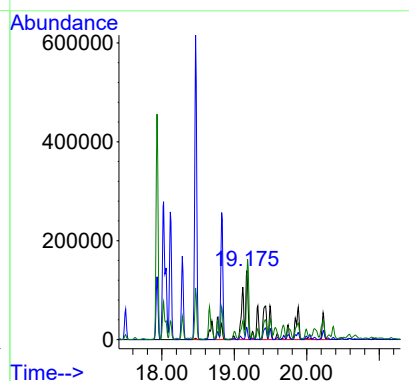
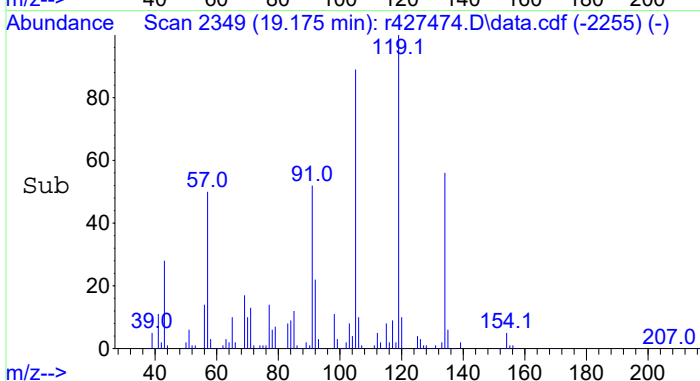

#29  
 C5-Benzenes  
 Concen: 13.01 ppbV m  
 RT: 19.675 min Scan# 2409  
 Delta R.T. 0.000 min  
 Lab File: r427474.D  
 Acq: 21 Apr 2023 7:43 AM

Tgt Ion	Ratio	Lower	Upper
148	100		
134	0.8	3.8	5.8#
91	15.0	62.6	94.0#

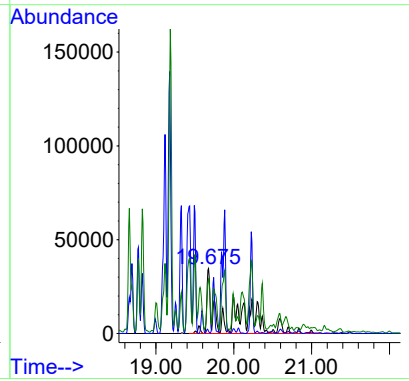
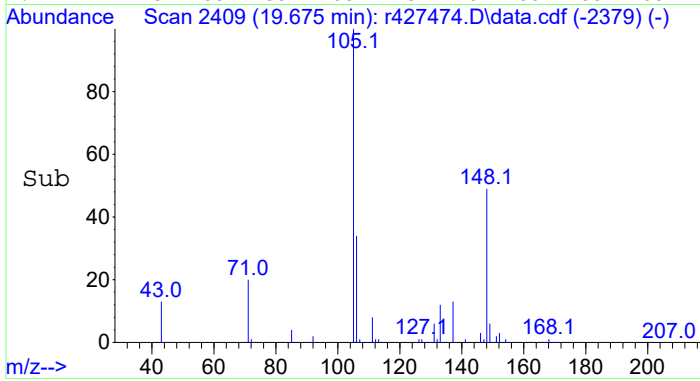



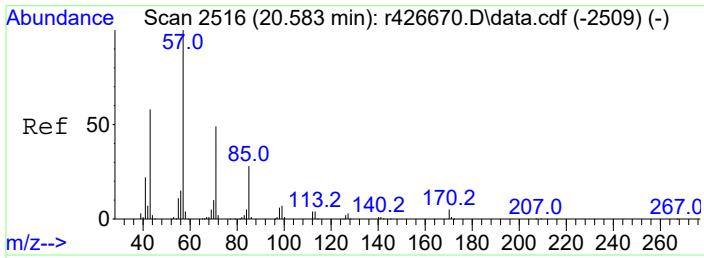

#30  
 dodecane  
 Concen: 9.18 ppbV  
 RT: 20.525 min Scan# 2509  
 Delta R.T. -0.017 min  
 Lab File: r427474.D  
 Acq: 21 Apr 2023 7:43 AM

Tgt Ion: 57 Resp: 596900  
 Ion Ratio Lower Upper  
 57 100  
 43 66.1 52.5 78.7

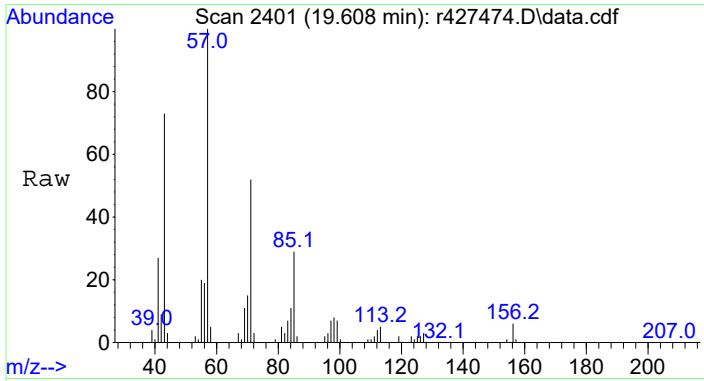
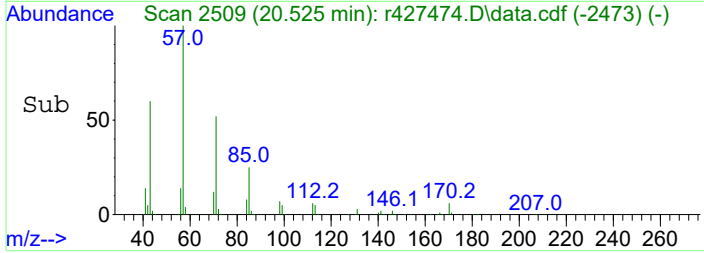
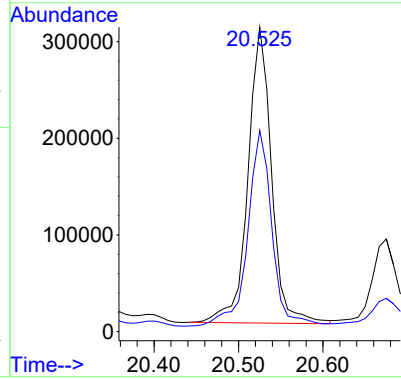
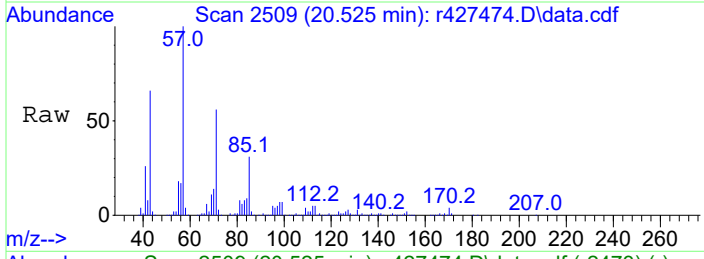

#31  
 C12 + Aliphatics  
 Concen: 1210.26 ppbV m  
 RT: 19.608 min Scan# 2401  
 Delta R.T. -0.008 min  
 Lab File: r427474.D  
 Acq: 21 Apr 2023 7:43 AM

Tgt Ion:TIC Resp:78702183

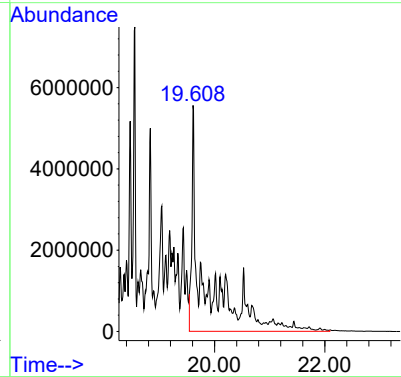
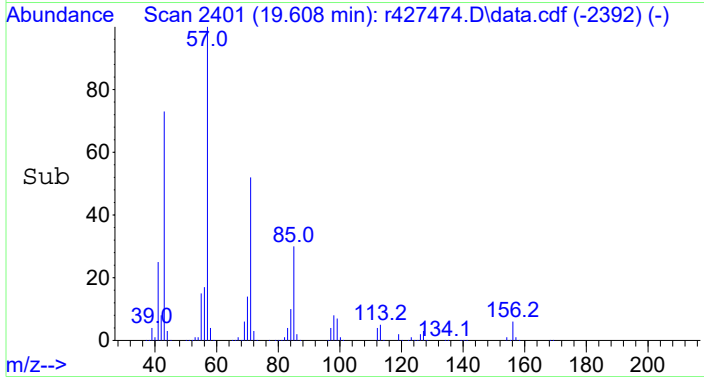

Data Path : C:\Projects\Hawaii DOH\2. Laboratory Data\Alpha\WAF Study\L2321418\TO15-LL\NF TO-15\  
 Data File : r1922258.D  
 Acq On : 12 May 2023 1:51 AM  
 Operator : AIRLAB19:TJS  
 Sample : L2321418-01D,3,0.5,250  
 Misc : WG1777877,ICAL19974  
 ALS Vial : 0 Sample Multiplier: 1

Quant Time: Jun 06 12:34:44 2023

Quant Method : C:\Projects\Hawaii DOH\2. Laboratory Data\Alpha\WAF Study\L2321418\TO15-LL\NF TO-15\TFS19 230501 NF.M

Quant Title : TO-14A/TO-15 SIM/Full Scan Analysis

QLast Update : Tue Jun 06 11:57:14 2023

Response via : Initial Calibration

Compound	R.T.	QIon	Response	Conc	Units	Dev (Min)	
Internal Standards							
1) bromochloromethane	8.383	49	395792	10.00	ppbV	0.00	
4) 1,4-difluorobenzene	10.583	114	966230	10.00	ppbV	0.00	
11) chlorobenzene-D5	15.367	54	203180	10.00	ppbV	0.00	
Target Compounds							
							Qvalue
2) pentane	5.590	43	152755	4.63	ppbV		100
3) C5 - < C6 Aliphatics	5.590	TIC	2017868m	61.15	ppbV		
5) hexane	8.458	57	157356	4.28	ppbV		100
6) C6 - < C7 Aliphatics	10.583	TIC	9991282m	271.78	ppbV		
7) benzene	10.157	78	60565	1.01	ppbV		100
8) C1 - Benzenes	10.157	78	60565	1.01	ppbV		100
9) heptane	11.743	43	436694	9.00	ppbV		100
10) C7 - C8 Aliphatics	14.650	TIC	31223979m	643.52	ppbV		
12) toluene	13.517	91	854297	12.03	ppbV		100
13) octane	14.642	85	581068	20.15	ppbV		100
14) ethylbenzene	15.758	91	657748	7.67	ppbV		100
15) m+p-xylene	15.908	91	1971994	28.57	ppbV		100
16) o-xylene	16.333	91	923951	13.60	ppbV		100
17) C2-Benzenes	15.908	91	3572705m	52.59	ppbV		
18) nonane	16.542	43	2160405	31.29	ppbV		100
19) C9 - < C10 Aliphatics	16.542	TIC	86551252m	1253.64	ppbV		
20) 1,3,5-trimethylbenzene	17.450	105	477709	6.29	ppbV		100
21) 1,2,4-Trimethylbenzene	17.783	105	1291581	18.21	ppbV		100
22) C3-Benzenes	17.783	105	4339984m	61.20	ppbV		
23) decane	17.867	57	2340729	31.84	ppbV		100
24) C10 - < C11 Aliphatics	17.867	TIC	51944103m	706.61	ppbV		
25) undecane	18.850	57	1537893	19.41	ppbV		100
26) C11 - < C12 Aliphatics	18.850	TIC	30408288m	383.86	ppbV		
27) 1,2,4,5-tetramethylben...	19.083	119	118530	3.25	ppbV		100
28) C4-Benzenes	18.450	134	914716m	25.05	ppbV		
29) C5-Benzenes	18.892	148	193051m	5.29	ppbV		
30) dodecane	19.692	57	268166	3.82	ppbV		100
31) C12 + Aliphatics	19.692	TIC	9206074m	130.98	ppbV		

(#) = qualifier out of range (m) = manual integration (+) = signals summed

Data Path : C:\Projects\Hawaii DOH\2. Laboratory Data\Alpha\WAF Study\L2321418\TO15-LL\NF TO-15\  
 Data File : r1922258.D  
 Acq On : 12 May 2023 1:51 AM  
 Operator : AIRLAB19:TJS  
 Sample : L2321418-01D,3,0.5,250  
 Misc : WG1777877,ICAL19974  
 ALS Vial : 0 Sample Multiplier: 1

Quant Time: Jun 06 12:34:44 2023  
 Quant Method : C:\Projects\Hawaii DOH\2. Laboratory Data\Alpha\WAF Study\L2321418\TO15-LL\NF TO-15\  
 ... 5\TFS19 230501 NF.M  
 Quant Title : TO-14A/TO-15 SIM/Full Scan Analysis  
 QLast Update : Tue Jun 06 11:57:14 2023  
 Response via : Initial Calibration

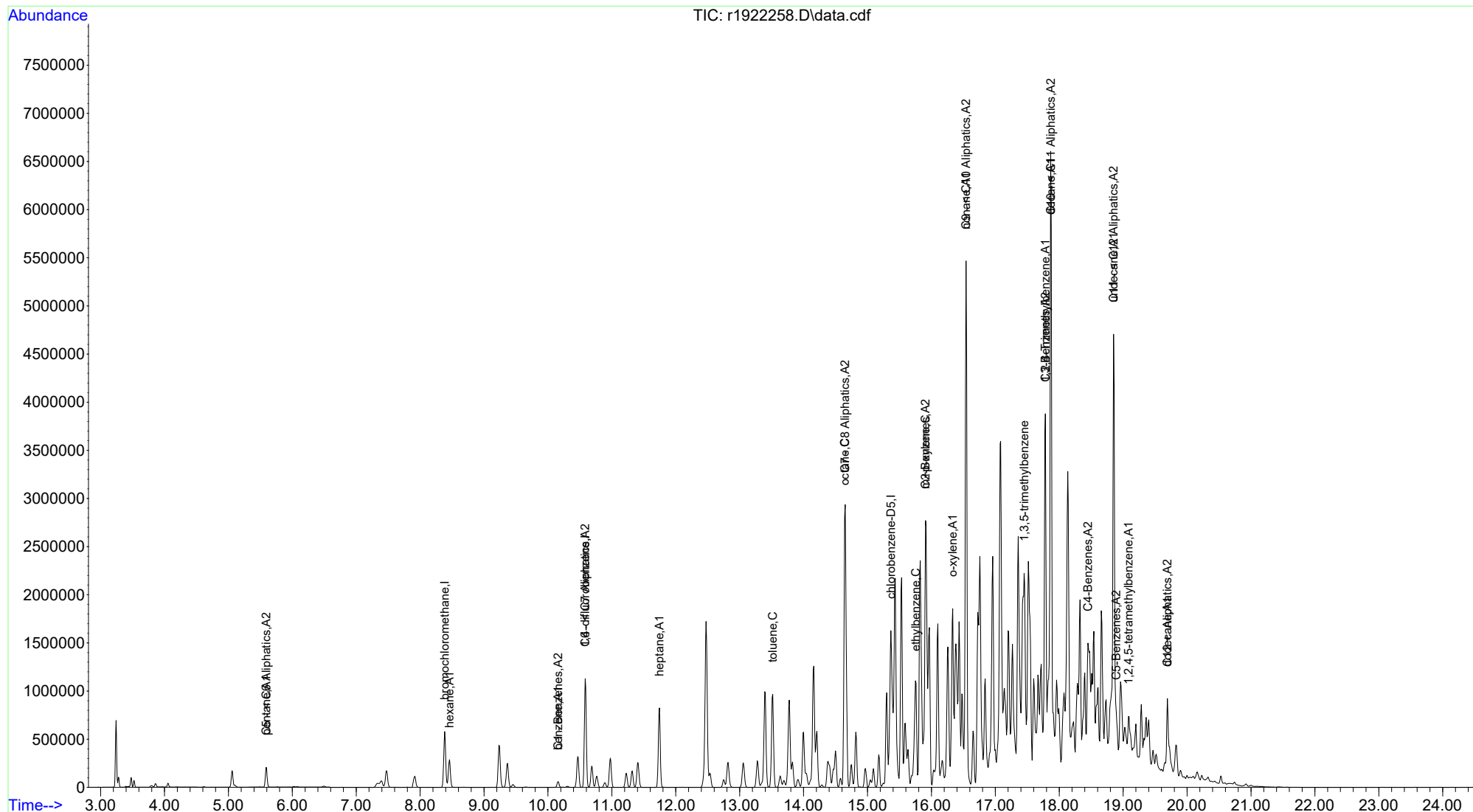

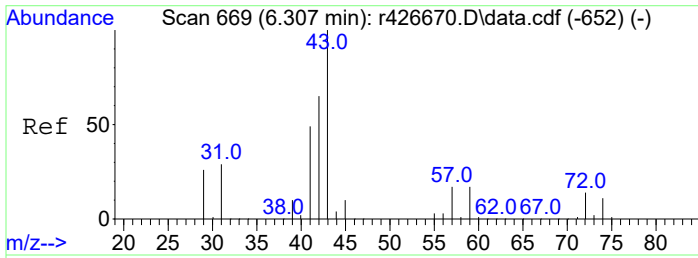

#2  
 pentane  
 Concen: 4.63 ppbV  
 RT: 5.590 min Scan# 592  
 Delta R.T. 0.000 min  
 Lab File: r1922258.D  
 Acq: 12 May 2023 1:51 AM

Tgt Ion	Resp	Lower	Upper
43	152755		
57	14.2	11.4	17.0
72	10.8	8.6	13.0

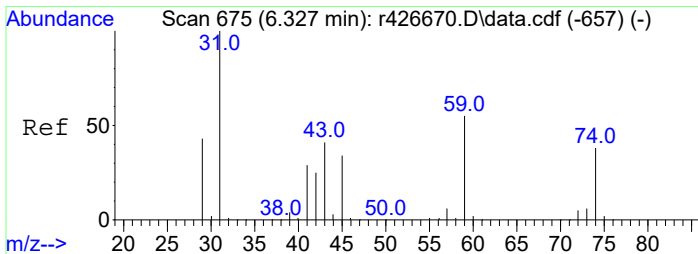
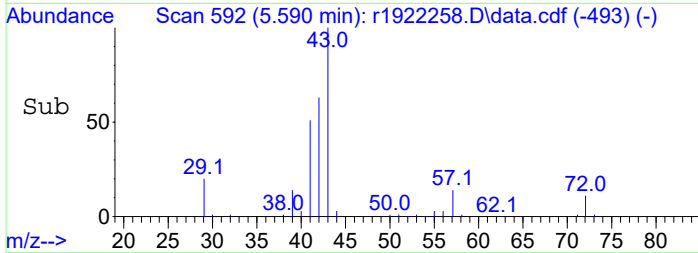
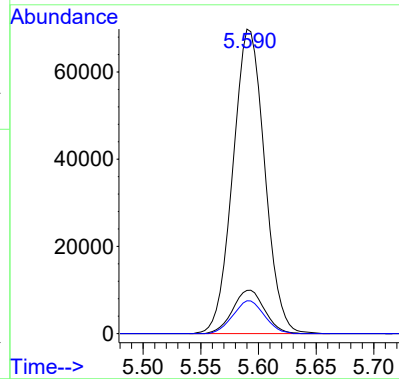
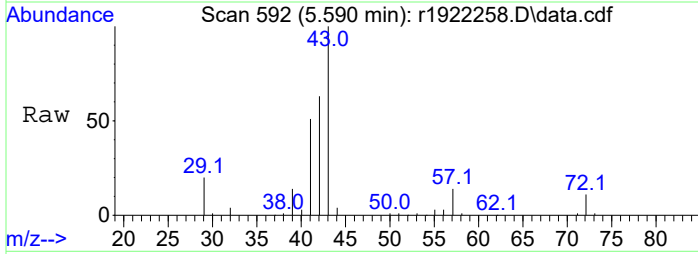

#3  
 C5 - < C6 Aliphatics  
 Concen: 61.15 ppbV m  
 RT: 5.590 min Scan# 592  
 Delta R.T. 0.000 min  
 Lab File: r1922258.D  
 Acq: 12 May 2023 1:51 AM

Tgt Ion	Resp	Lower	Upper
TIC	2017868		
59	0.0	0.0	0.0
45	0.0	0.0	0.0

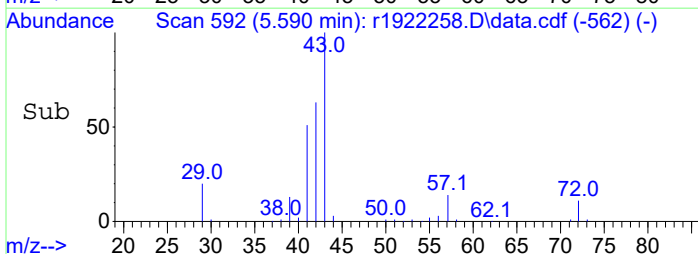
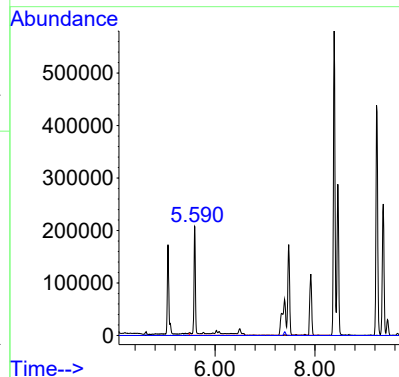
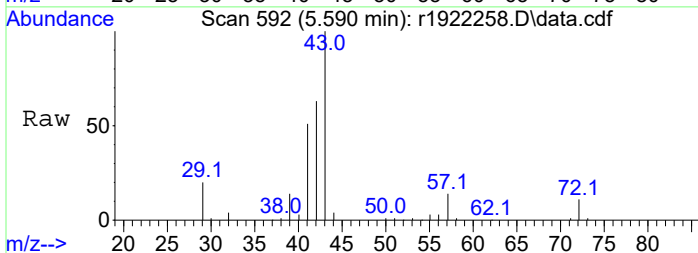

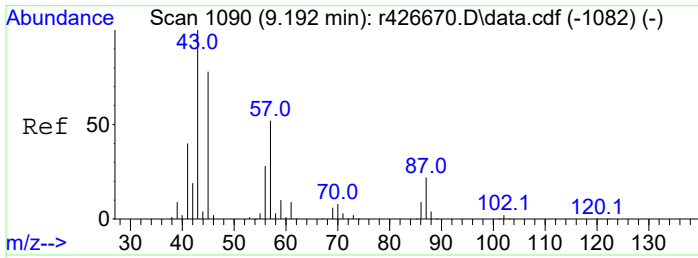

#5  
hexane  
Concen: 4.28 ppbV  
RT: 8.458 min Scan# 984  
Delta R.T. 0.000 min  
Lab File: r1922258.D  
Acq: 12 May 2023 1:51 AM

Tgt Ion:	Resp:	Lower	Upper
57	157356		
57	100		
43	69.7	55.8	83.6
86	17.7	14.2	21.2

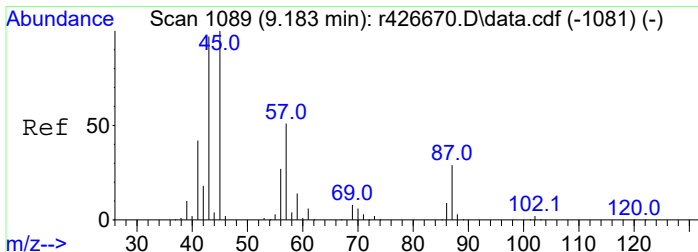
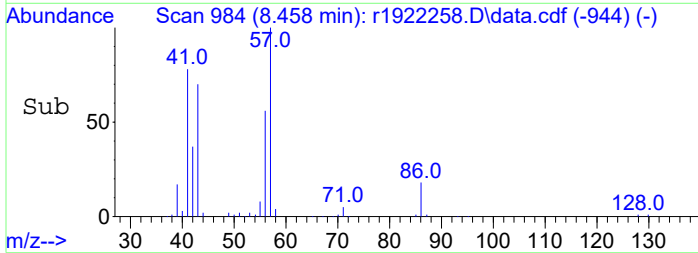
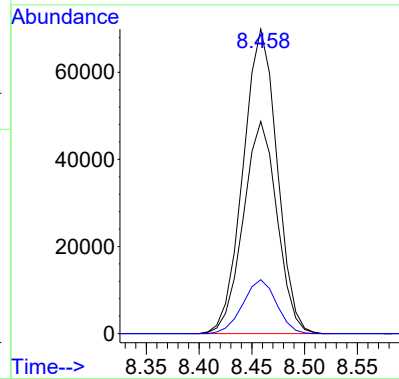
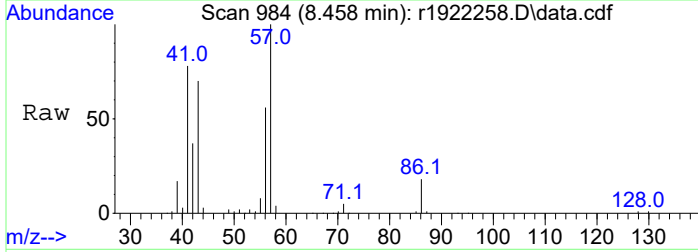

#6  
C6 - < C7 Aliphatics  
Concen: 271.78 ppbV m  
RT: 10.583 min Scan# 1262  
Delta R.T. 0.000 min  
Lab File: r1922258.D  
Acq: 12 May 2023 1:51 AM

Tgt Ion:	TIC	Resp:	Lower	Upper
59	0.0	9991282	0.0	0.0
45	204600.0	14.5	21.7#	

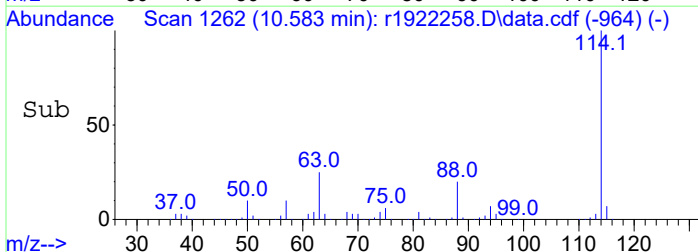
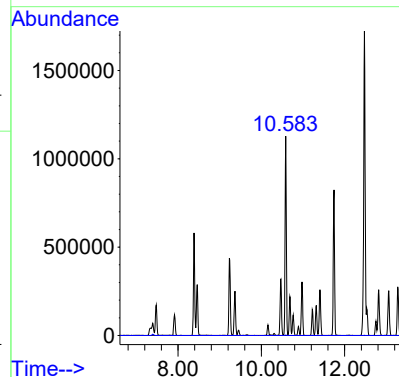
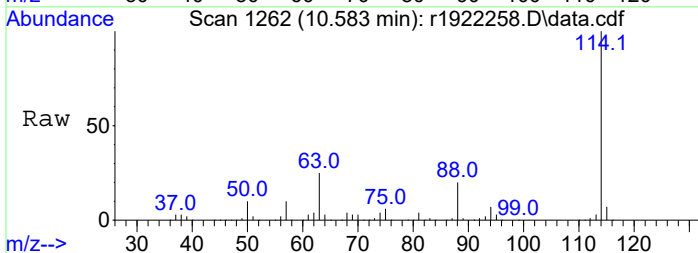

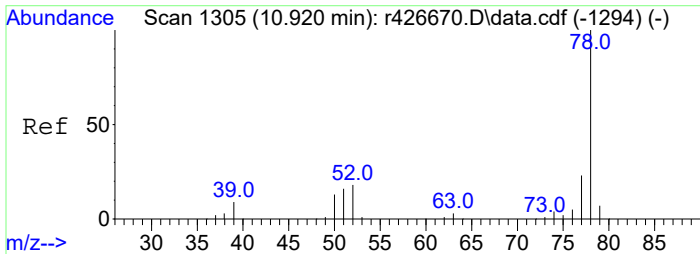

#7  
benzene  
Concen: 1.01 ppbV  
RT: 10.157 min Scan# 1198  
Delta R.T. 0.000 min  
Lab File: r1922258.D  
Acq: 12 May 2023 1:51 AM

Tgt Ion	Resp	Lower	Upper
78	100		
52	18.6	14.9	22.3

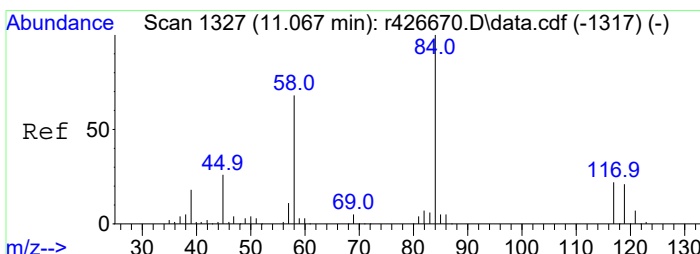
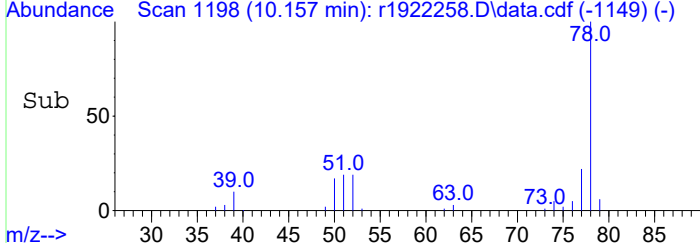
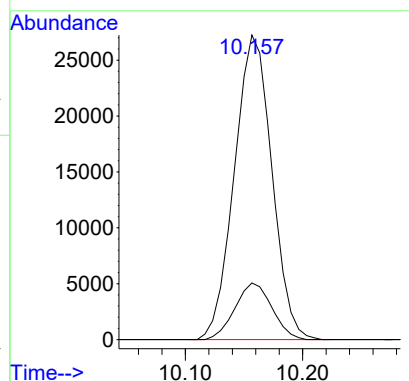
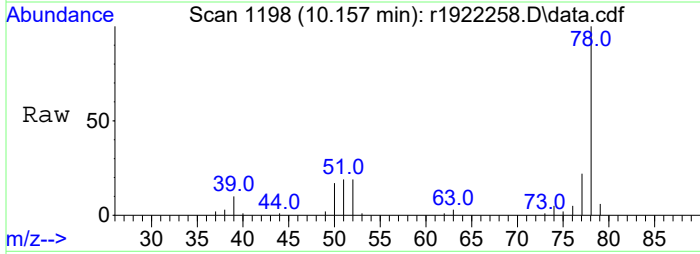

#8  
C1 - Benzenes  
Concen: 1.01 ppbV  
RT: 10.157 min Scan# 1198  
Delta R.T. 0.000 min  
Lab File: r1922258.D  
Acq: 12 May 2023 1:51 AM

Tgt Ion	Resp	Lower	Upper
78	100		
52	18.6	14.9	22.3

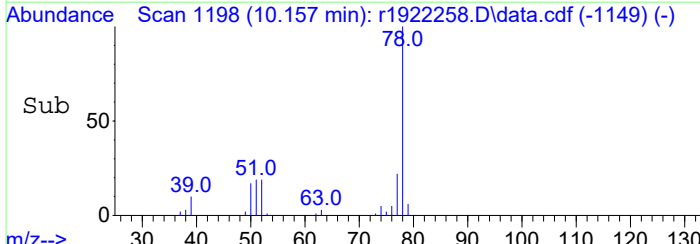
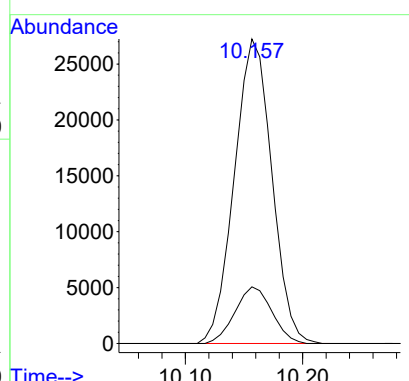
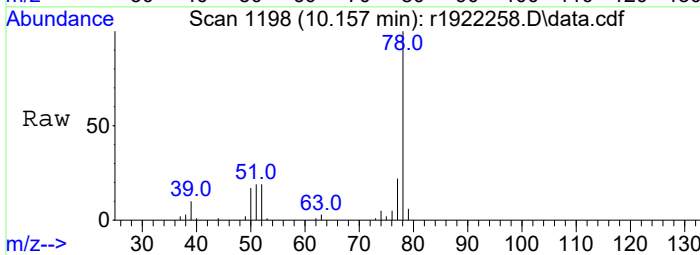

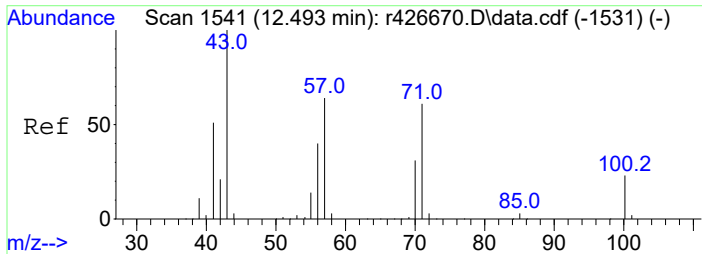

#9  
 heptane  
 Concen: 9.00 ppbV  
 RT: 11.743 min Scan# 1436  
 Delta R.T. 0.000 min  
 Lab File: r1922258.D  
 Acq: 12 May 2023 1:51 AM

Tgt Ion	Resp	Lower	Upper
43	436694		
57	47.4	37.9	56.9
100	16.8	13.4	20.2

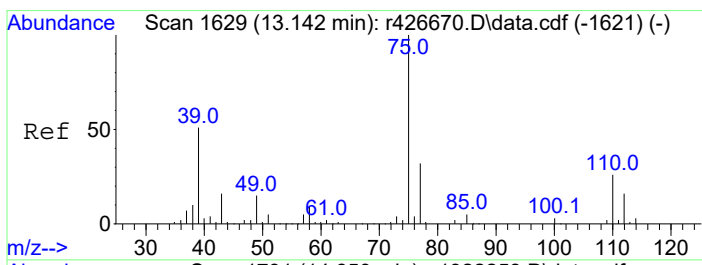
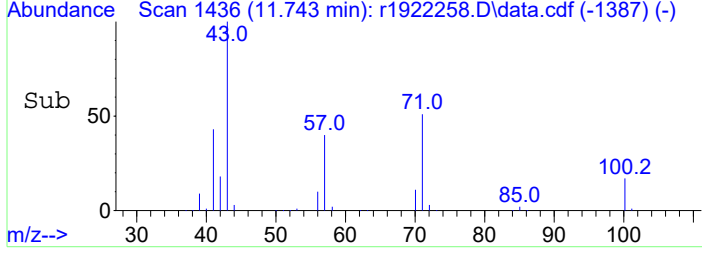
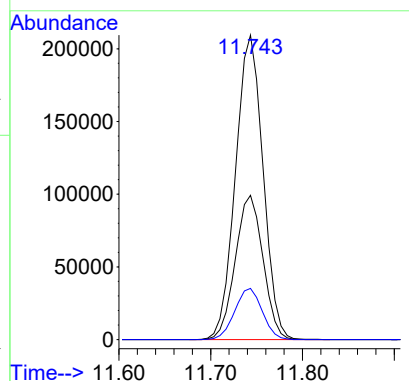
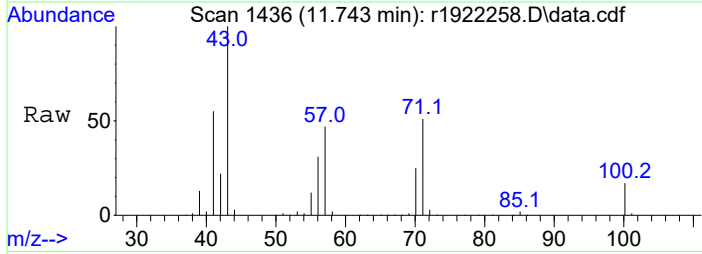

#10  
 C7 - C8 Aliphatics  
 Concen: 643.52 ppbV m  
 RT: 14.650 min Scan# 1791  
 Delta R.T. 0.000 min  
 Lab File: r1922258.D  
 Acq: 12 May 2023 1:51 AM

Tgt Ion	Resp	Lower	Upper
TIC	31223979		
39	8363800.0	227.8	341.8#
77	211800.0	5.8	8.6#

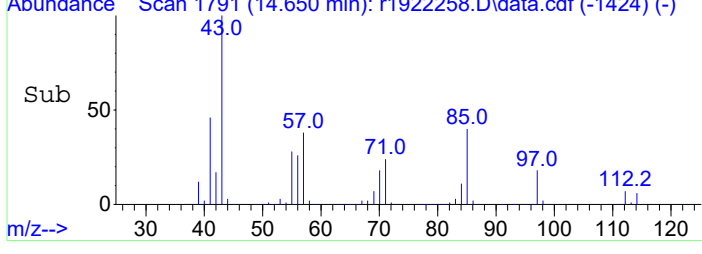
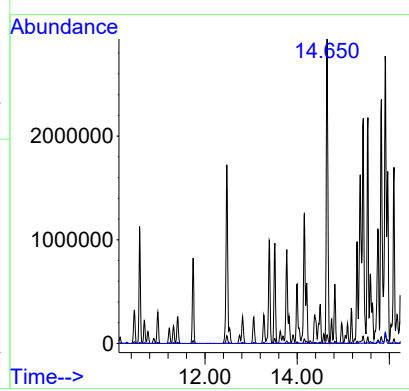
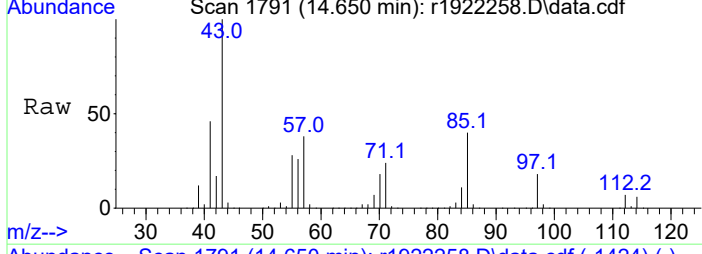

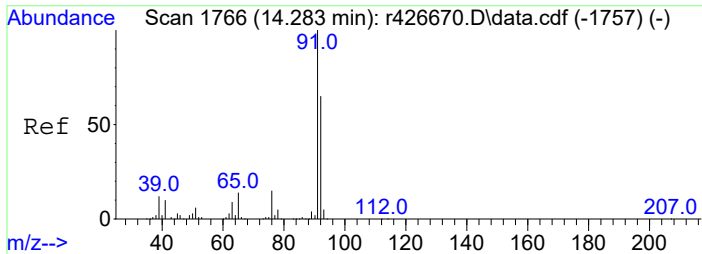

#12  
 toluene  
 Concen: 12.03 ppbV  
 RT: 13.517 min Scan# 1655  
 Delta R.T. 0.000 min  
 Lab File: r1922258.D  
 Acq: 12 May 2023 1:51 AM

Tgt Ion	Resp	Lower	Upper
91	100		
92	63.7	51.0	76.4

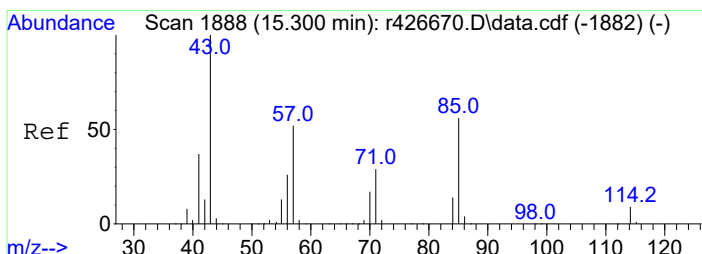
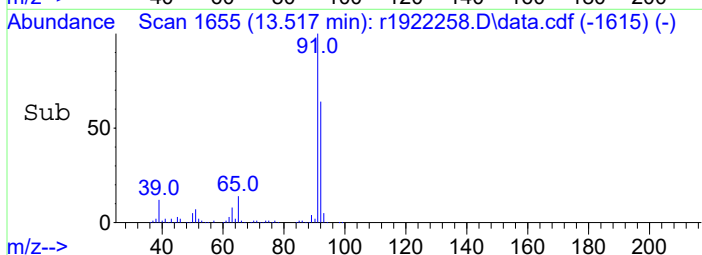
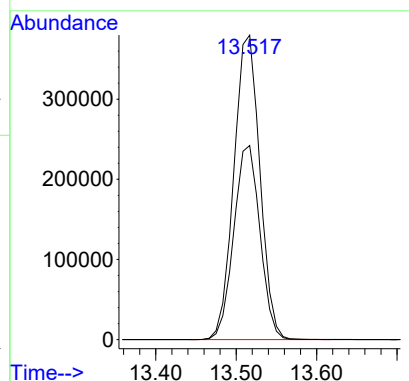
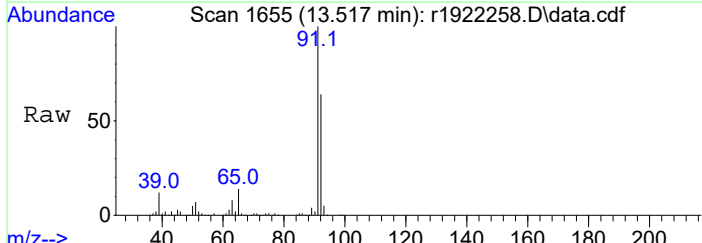

#13  
 octane  
 Concen: 20.15 ppbV  
 RT: 14.642 min Scan# 1790  
 Delta R.T. 0.000 min  
 Lab File: r1922258.D  
 Acq: 12 May 2023 1:51 AM

Tgt Ion	Resp	Lower	Upper
85	100		
57	91.5	73.2	109.8
114	14.2	11.4	17.0
43	237.5	190.0	285.0

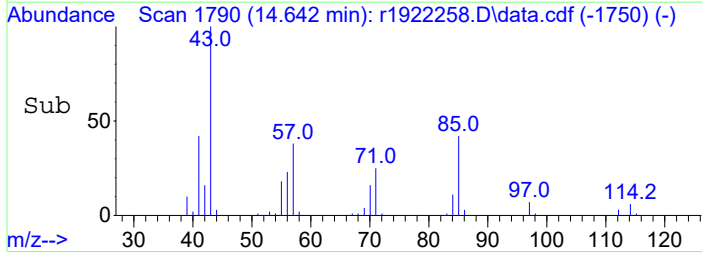
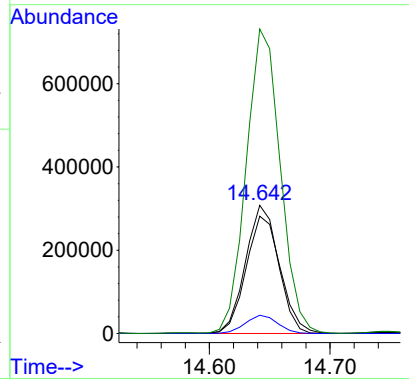
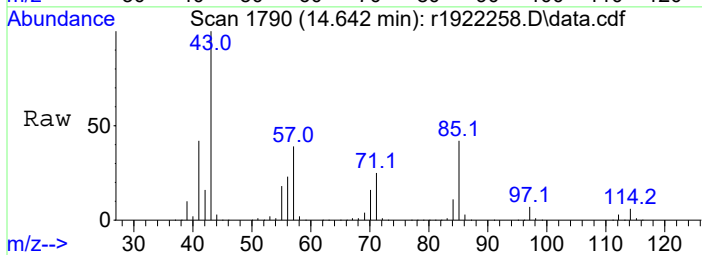



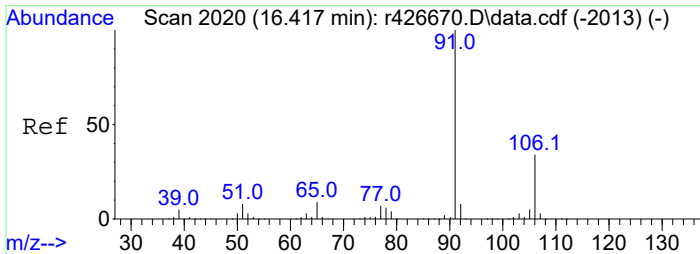

#14  
ethylbenzene  
Concen: 7.67 ppbV  
RT: 15.758 min Scan# 1922  
Delta R.T. 0.000 min  
Lab File: r1922258.D  
Acq: 12 May 2023 1:51 AM

Tgt Ion	Resp	Lower	Upper
91	100		
106	32.4	25.9	38.9

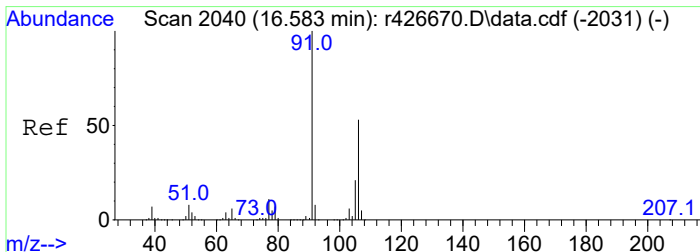
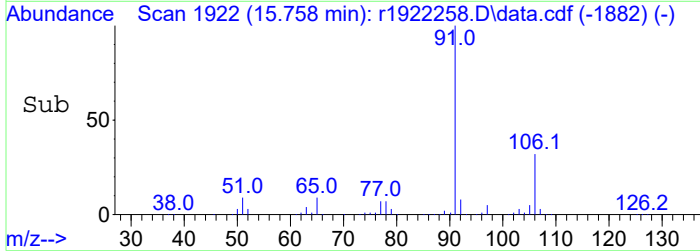
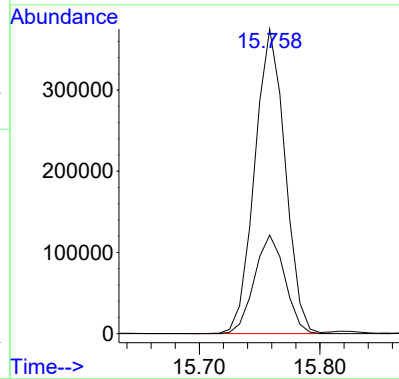
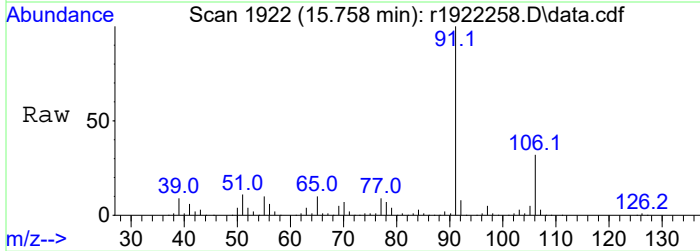

#15  
m+p-xylene  
Concen: 28.57 ppbV  
RT: 15.908 min Scan# 1940  
Delta R.T. 0.000 min  
Lab File: r1922258.D  
Acq: 12 May 2023 1:51 AM

Tgt Ion	Resp	Lower	Upper
91	100		
106	50.8	40.6	61.0

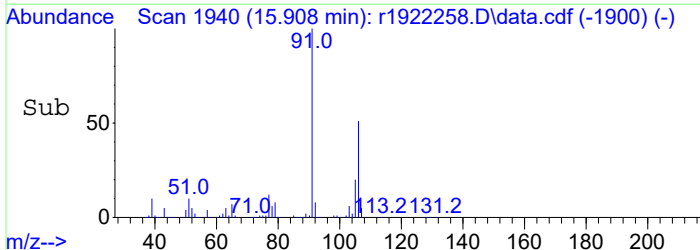
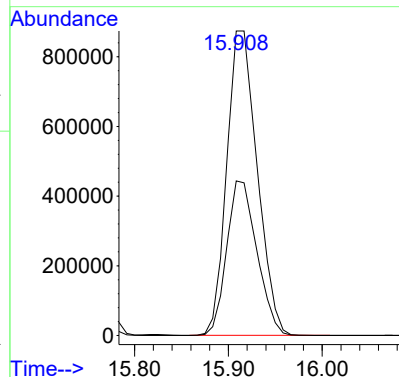
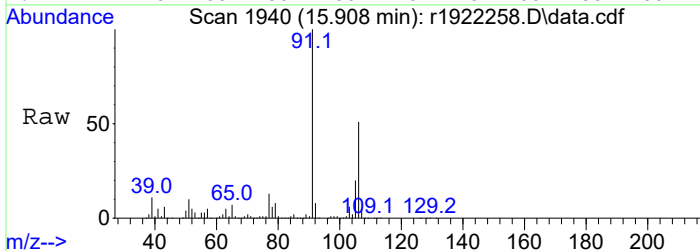

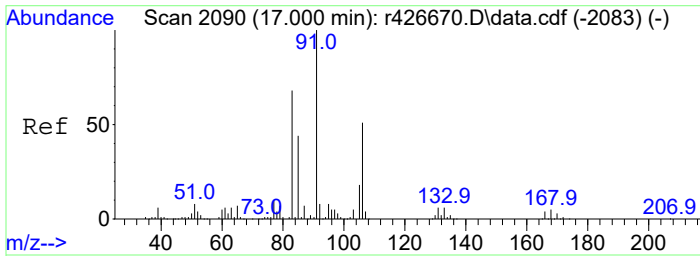

#16  
 o-xylene  
 Concen: 13.60 ppbV  
 RT: 16.333 min Scan# 1991  
 Delta R.T. 0.000 min  
 Lab File: r1922258.D  
 Acq: 12 May 2023 1:51 AM

Tgt Ion: 91 Resp: 923951  
 Ion Ratio Lower Upper  
 91 100  
 106 47.8 38.2 57.4

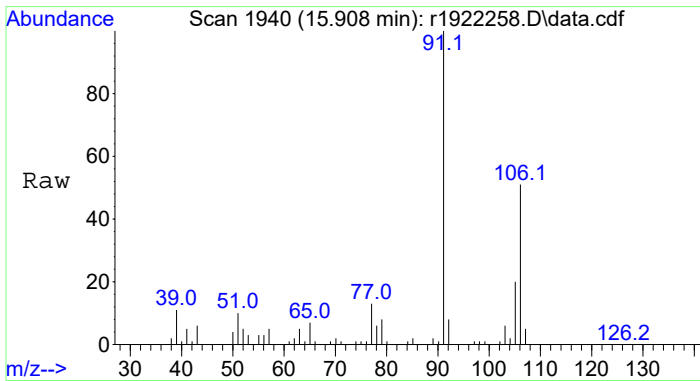
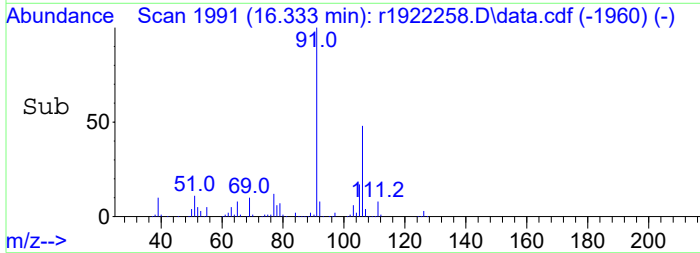
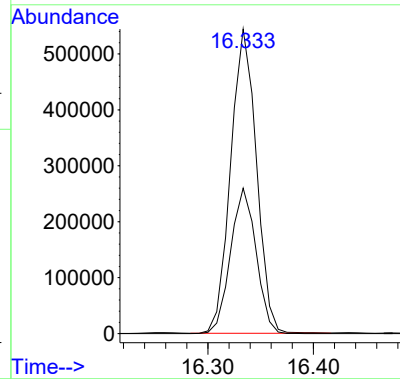
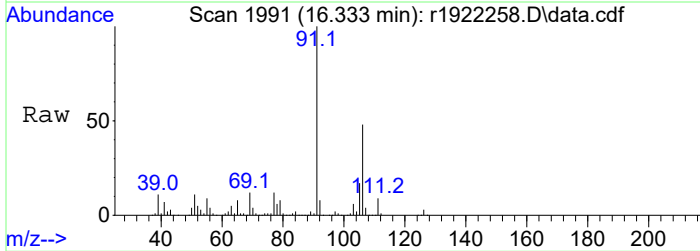

#17  
 C2-Benzenes  
 Concen: 52.59 ppbV m  
 RT: 15.908 min Scan# 1940  
 Delta R.T. 0.000 min  
 Lab File: r1922258.D  
 Acq: 12 May 2023 1:51 AM

Tgt Ion: 91 Resp: 3572705  
 Ion Ratio Lower Upper  
 91 100  
 106 50.8 40.6 61.0

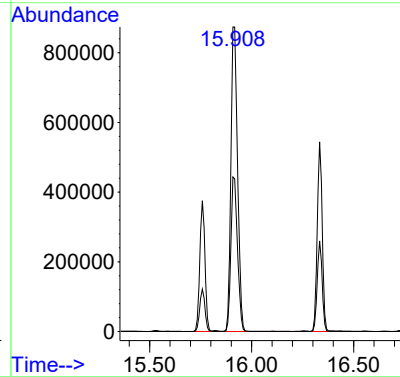
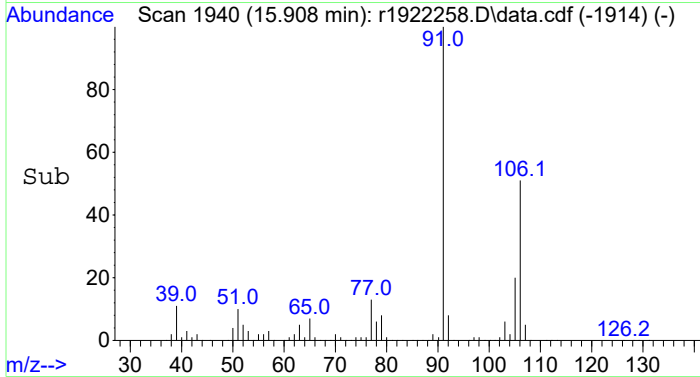

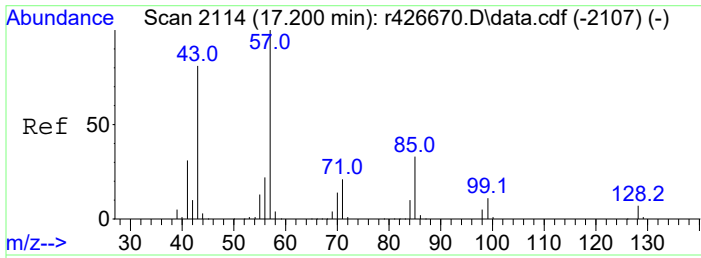

#18  
 nonane  
 Concen: 31.29 ppbV  
 RT: 16.542 min Scan# 2016  
 Delta R.T. 0.000 min  
 Lab File: r1922258.D  
 Acq: 12 May 2023 1:51 AM

Tgt Ion: 43 Resp: 2160405

Ion	Ratio	Lower	Upper
43	100		
57	88.4	70.7	106.1
128	6.2	5.0	7.4

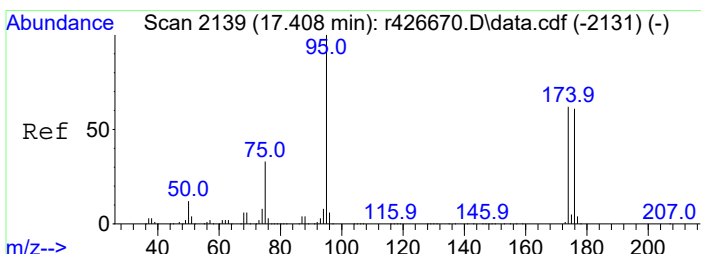
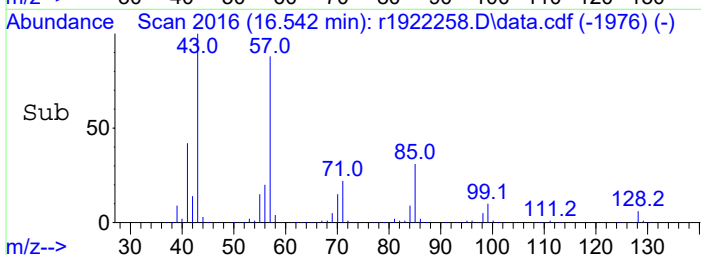
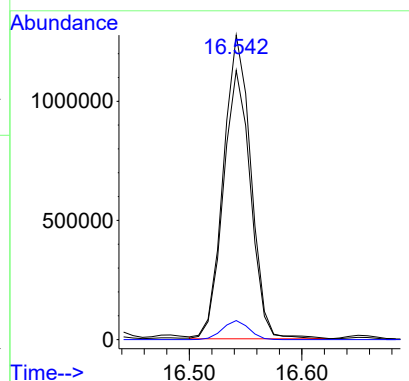
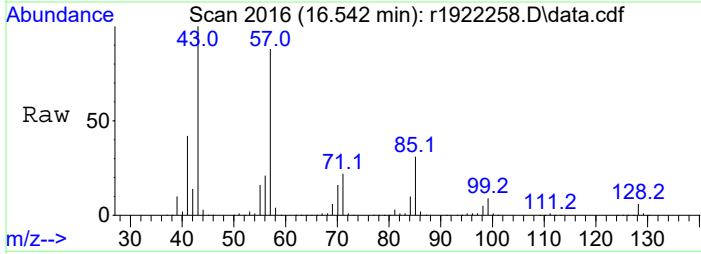

#19  
 C9 - < C10 Aliphatics  
 Concen: 1253.64 ppbV m  
 RT: 16.542 min Scan# 2016  
 Delta R.T. 0.000 min  
 Lab File: r1922258.D  
 Acq: 12 May 2023 1:51 AM

Tgt Ion:TIC Resp:86551252

Ion	Ratio	Lower	Upper
TIC	100		
174	0.0	0.0	0.0
75	0.0	0.0	0.0

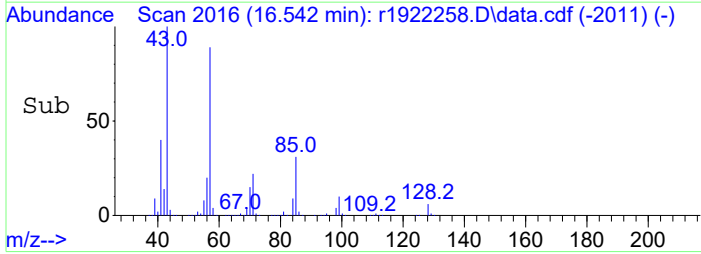
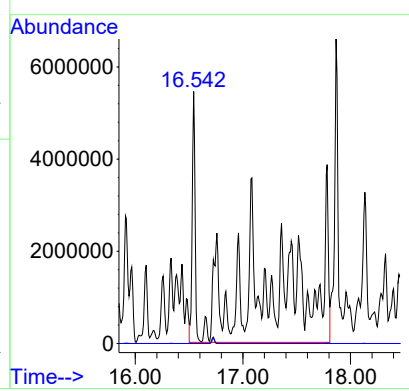
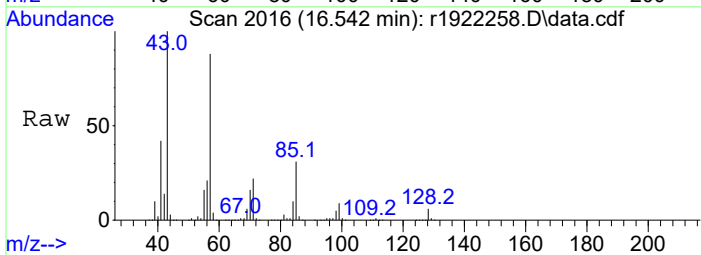

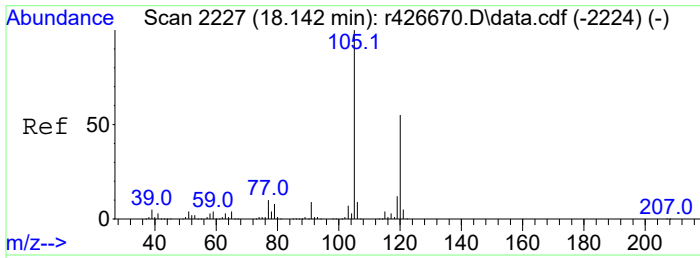

#20  
 1,3,5-trimethylbenzene  
 Concen: 6.29 ppbV  
 RT: 17.450 min Scan# 2125  
 Delta R.T. 0.000 min  
 Lab File: r1922258.D  
 Acq: 12 May 2023 1:51 AM

Tgt Ion	Resp	Lower	Upper
105	477709		
105	100		
120	50.7	40.6	60.8
91	10.8	8.6	13.0

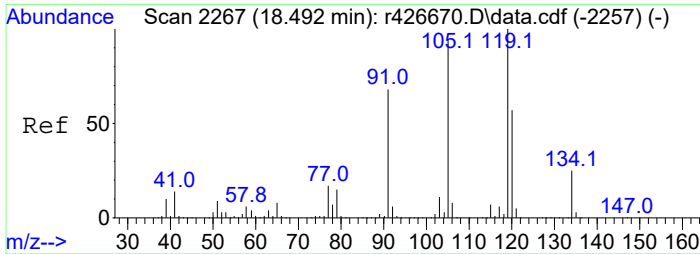
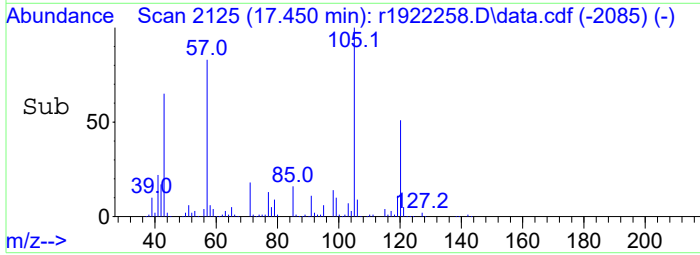
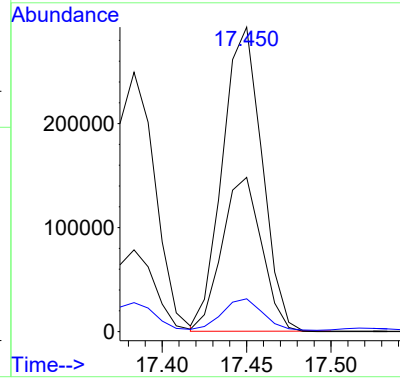
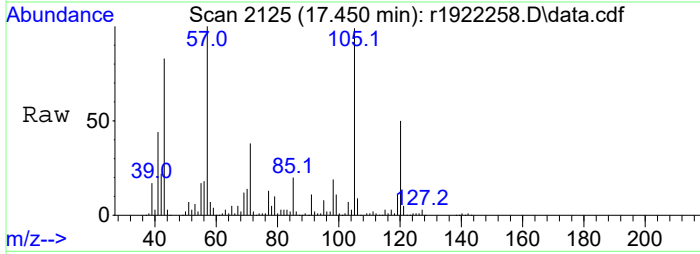

#21  
 1,2,4-Trimethylbenzene  
 Concen: 18.21 ppbV  
 RT: 17.783 min Scan# 2163  
 Delta R.T. 0.000 min  
 Lab File: r1922258.D  
 Acq: 12 May 2023 1:51 AM

Tgt Ion	Resp	Lower	Upper
105	1291581		
105	100		
120	47.7	38.2	57.2
91	11.5	9.2	13.8

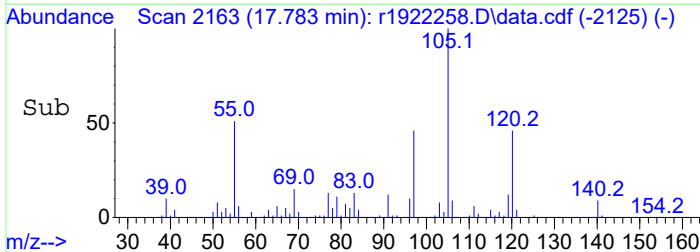
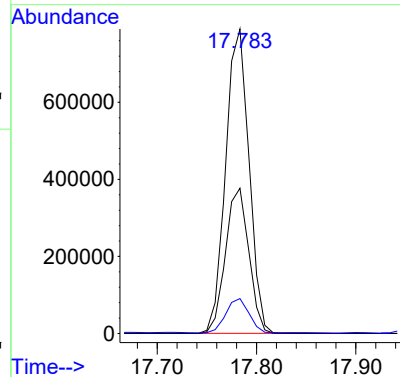
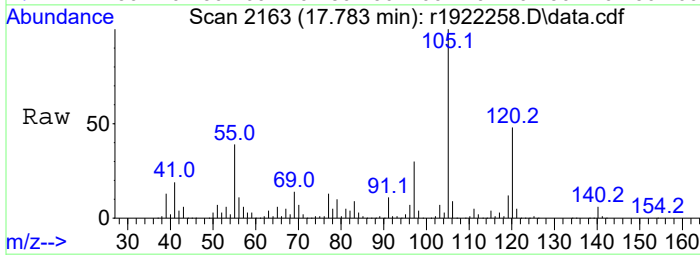

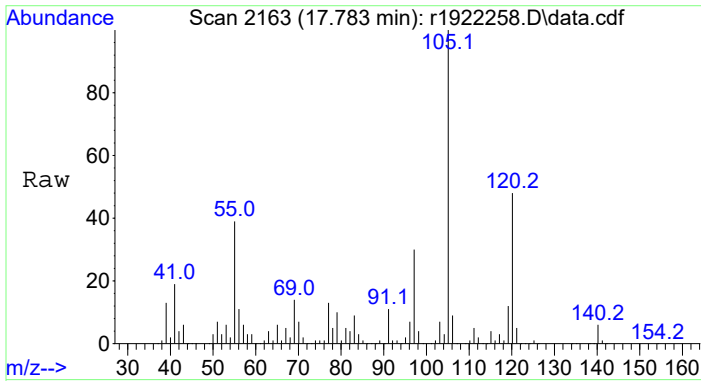

#22  
 C3-Benzenes  
 Concen: 61.20 ppbV m  
 RT: 17.783 min Scan# 2163  
 Delta R.T. 0.000 min  
 Lab File: r1922258.D  
 Acq: 12 May 2023 1:51 AM

Tgt Ion	Resp	Lower	Upper
105	100		
120	14.2	38.2	57.2#
91	3.3	9.2	13.8#

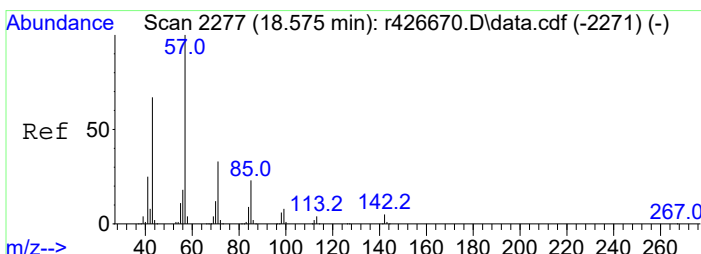
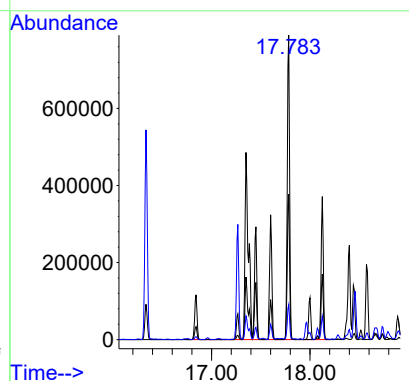
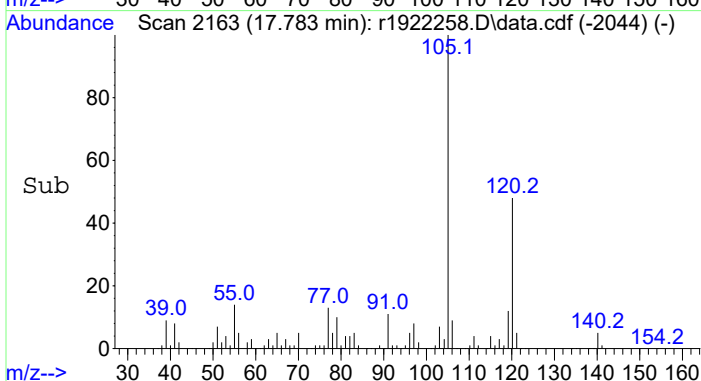

#23  
 decane  
 Concen: 31.84 ppbV  
 RT: 17.867 min Scan# 2173  
 Delta R.T. 0.000 min  
 Lab File: r1922258.D  
 Acq: 12 May 2023 1:51 AM

Tgt Ion	Resp	Lower	Upper
57	100		
43	92.0	73.6	110.4
142	5.3	4.2	6.4

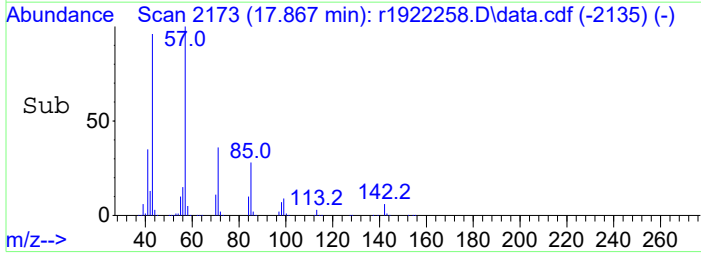
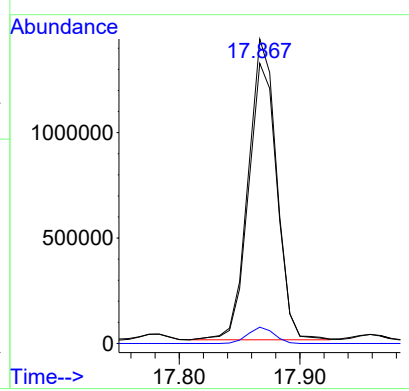
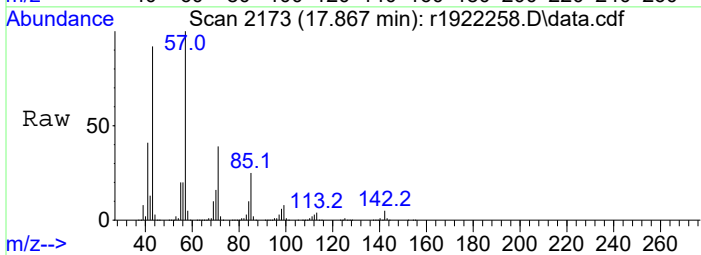

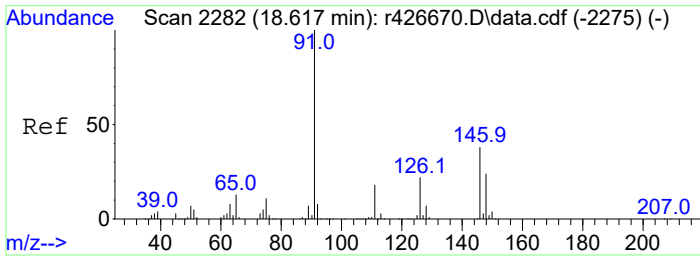

#24  
 C10 - < C11 Aliphatics  
 Concen: 706.61 ppbV m  
 RT: 17.867 min Scan# 2173  
 Delta R.T. 0.000 min  
 Lab File: r1922258.D  
 Acq: 12 May 2023 1:51 AM

Tgt Ion:TIC Resp:51944103  
 Ion Ratio Lower Upper  
 TIC 100  
 126 179000.0 2.2 3.2#

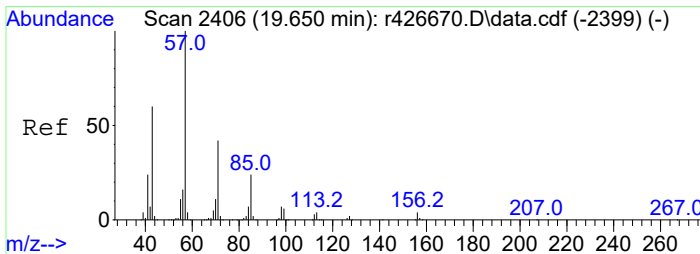
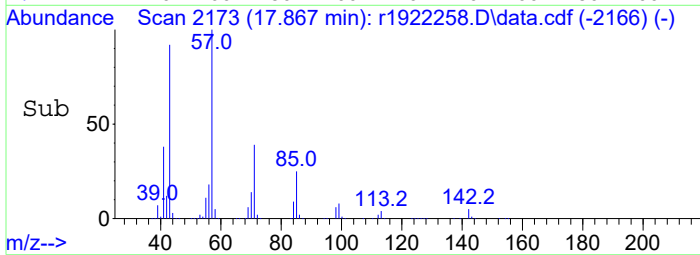
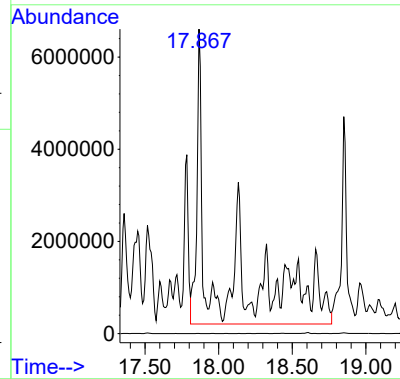
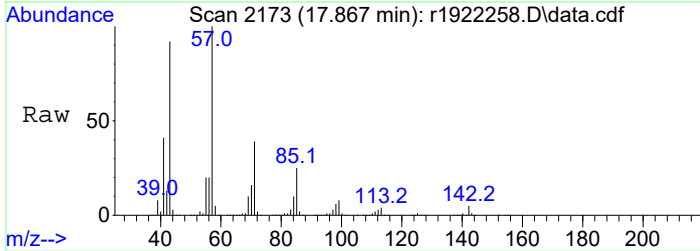

#25  
 undecane  
 Concen: 19.41 ppbV  
 RT: 18.850 min Scan# 2291  
 Delta R.T. 0.000 min  
 Lab File: r1922258.D  
 Acq: 12 May 2023 1:51 AM

Tgt Ion: 57 Resp: 1537893  
 Ion Ratio Lower Upper  
 57 100  
 43 83.6 66.9 100.3  
 71 46.9 37.5 56.3  
 156 4.0 3.2 4.8

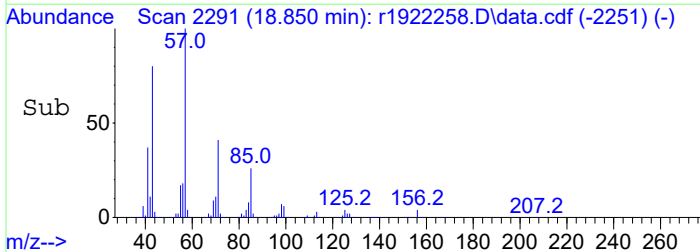
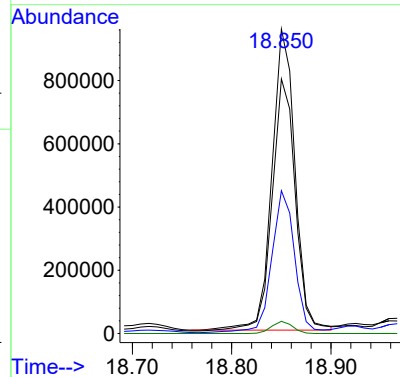
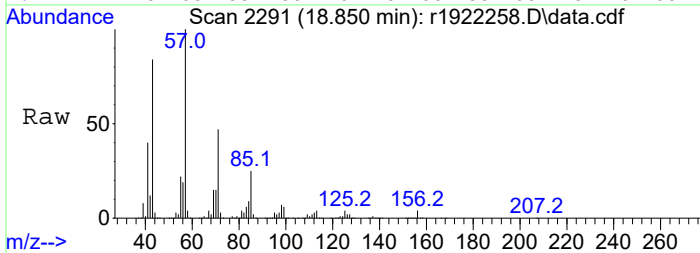

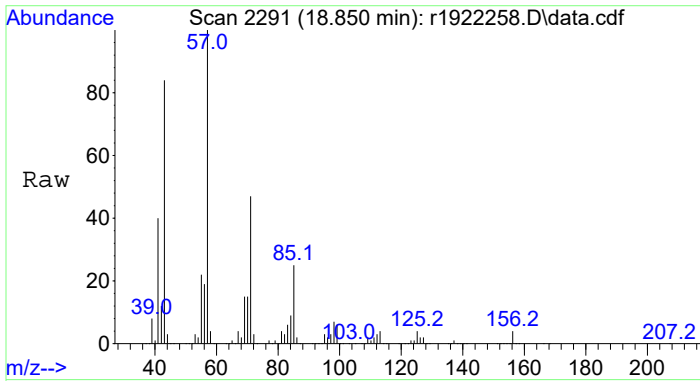

#26  
 C11 - < C12 Aliphatics  
 Concen: 383.86 ppbV m  
 RT: 18.850 min Scan# 2291  
 Delta R.T. 0.000 min  
 Lab File: r1922258.D  
 Acq: 12 May 2023 1:51 AM  
 Tgt Ion:TIC Resp:30408288

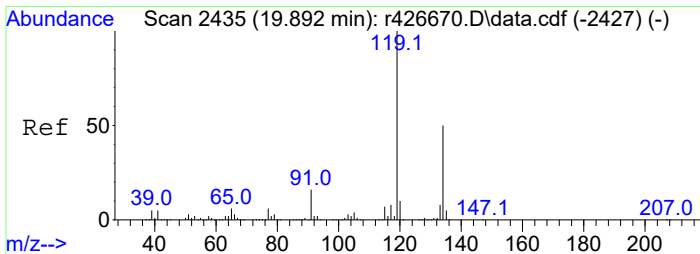
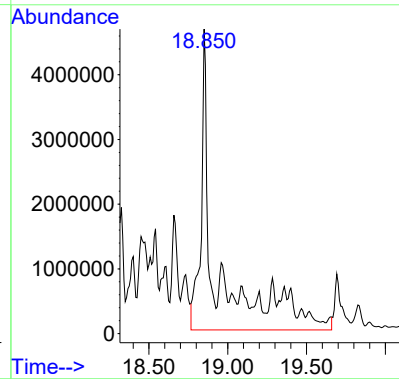
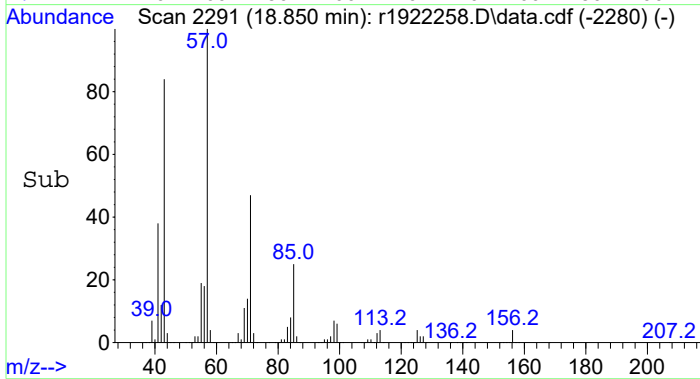

#27  
 1,2,4,5-tetramethylbenzene  
 Concen: 3.25 ppbV  
 RT: 19.083 min Scan# 2319  
 Delta R.T. 0.000 min  
 Lab File: r1922258.D  
 Acq: 12 May 2023 1:51 AM

Tgt Ion:119 Resp: 118530

Ion	Ratio	Lower	Upper
119	100		
134	47.2	37.8	56.6
91	27.8	22.2	33.4

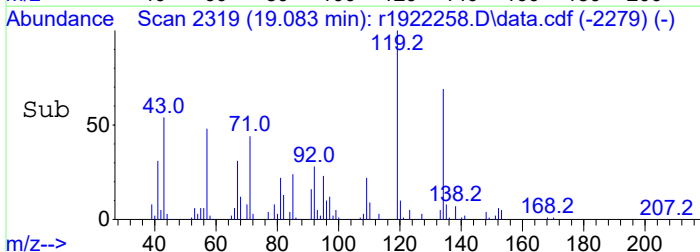
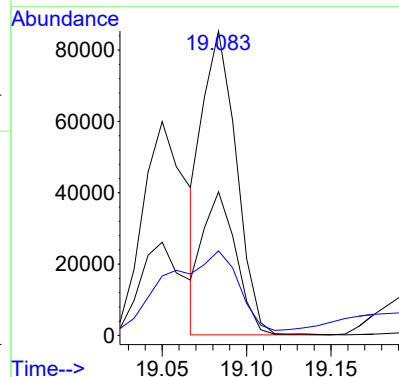
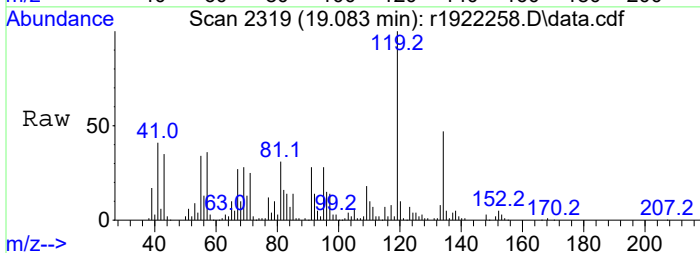

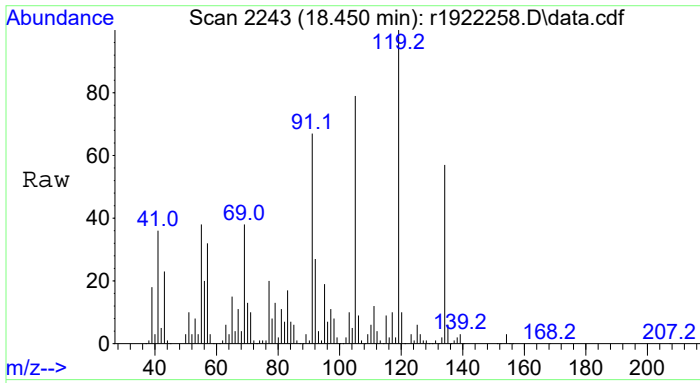

#28  
 C4-Benzenes  
 Concen: 25.05 ppbV m  
 RT: 18.450 min Scan# 2243  
 Delta R.T. 0.000 min  
 Lab File: r1922258.D  
 Acq: 12 May 2023 1:51 AM

Tgt Ion	Resp	Lower	Upper
134	100		
120	2.7	13.4	20.2#
91	24.2	93.0	139.6#

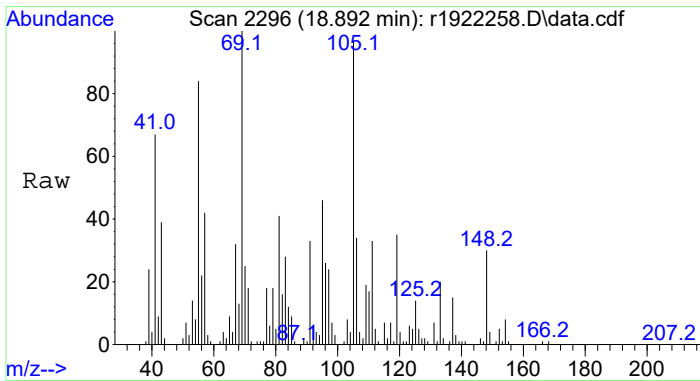
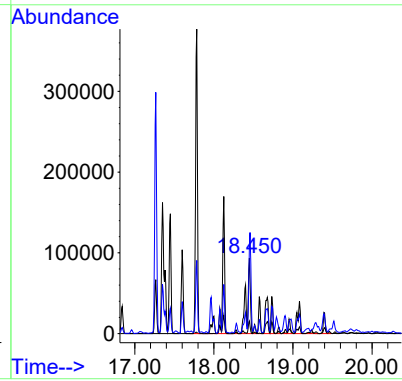
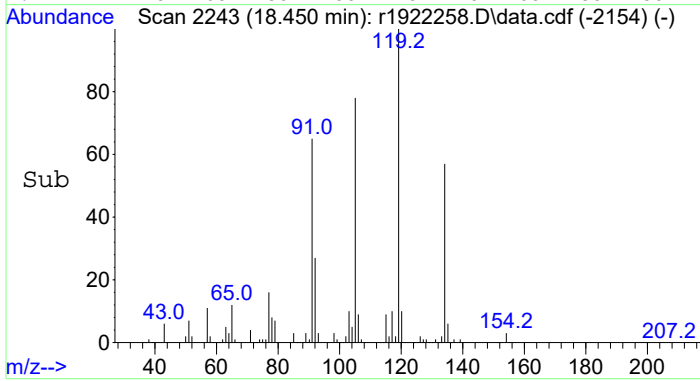

#29  
 C5-Benzenes  
 Concen: 5.29 ppbV m  
 RT: 18.892 min Scan# 2296  
 Delta R.T. 0.000 min  
 Lab File: r1922258.D  
 Acq: 12 May 2023 1:51 AM

Tgt Ion	Resp	Lower	Upper
148	100		
134	1.3	6.0	9.0#
91	22.0	88.3	132.5#

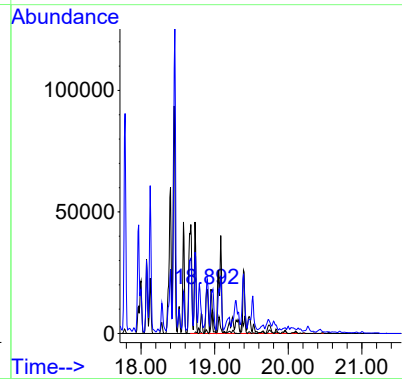
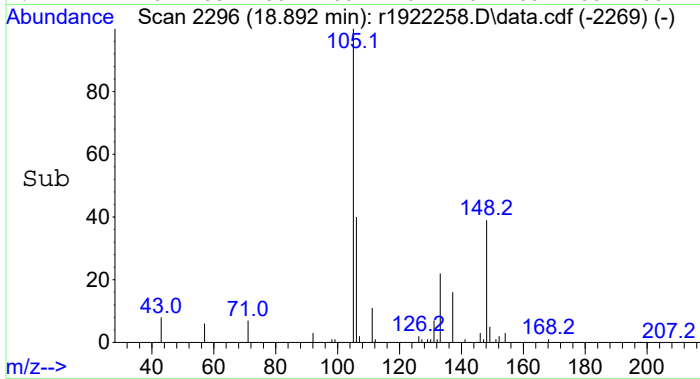



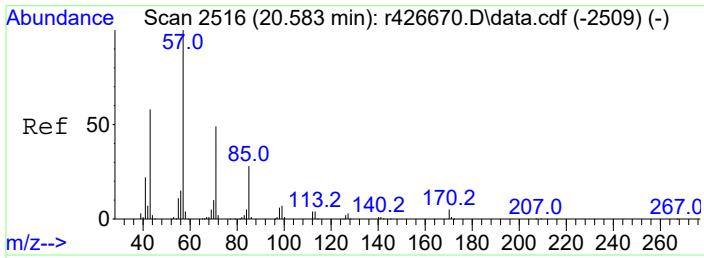

#30  
 dodecane  
 Concen: 3.82 ppbV  
 RT: 19.692 min Scan# 2390  
 Delta R.T. 0.000 min  
 Lab File: r1922258.D  
 Acq: 12 May 2023 1:51 AM

Tgt Ion: 57 Resp: 268166  
 Ion Ratio Lower Upper  
 57 100  
 43 79.5 63.6 95.4

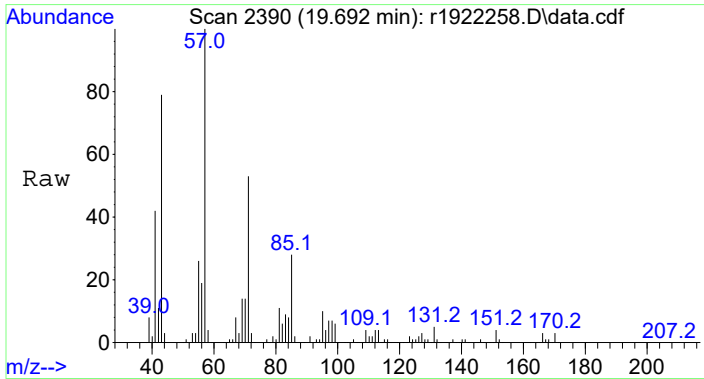
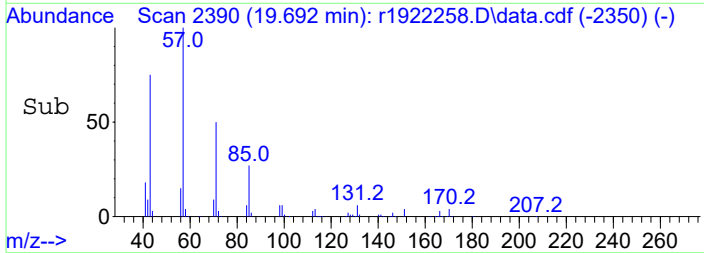
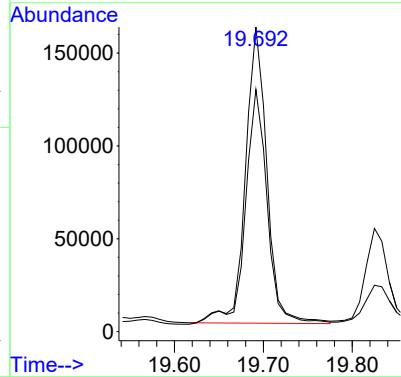
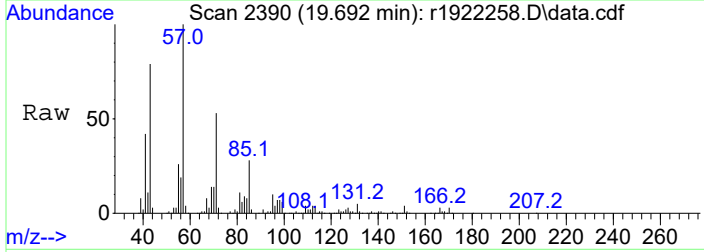

#31  
 C12 + Aliphatics  
 Concen: 130.98 ppbV m  
 RT: 19.692 min Scan# 2390  
 Delta R.T. 0.000 min  
 Lab File: r1922258.D  
 Acq: 12 May 2023 1:51 AM

Tgt Ion:TIC Resp: 9206074

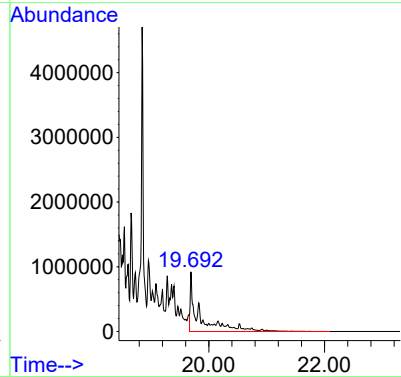
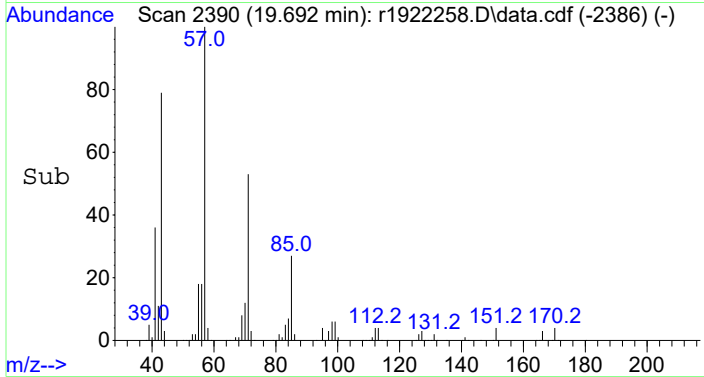

Data Path : C:\Projects\Hawaii DOH\2. Laboratory Data\Alpha\WAF Study\L2321418\TO15-LL\NF TO-15\  
 Data File : r1922260.D  
 Acq On : 12 May 2023 3:07 AM  
 Operator : AIRLAB19:TJS  
 Sample : L2321418-02D,3,0.5,250  
 Misc : WG1777877,ICAL19974  
 ALS Vial : 0 Sample Multiplier: 1

Quant Time: Jun 06 12:38:38 2023

Quant Method : C:\Projects\Hawaii DOH\2. Laboratory Data\Alpha\WAF Study\L2321418\TO15-LL\NF TO-15\TFS19 230501 NF.M

Quant Title : TO-14A/TO-15 SIM/Full Scan Analysis

QLast Update : Tue Jun 06 11:57:14 2023

Response via : Initial Calibration

Compound	R.T.	QIon	Response	Conc	Units	Dev (Min)	
Internal Standards							
1) bromochloromethane	8.383	49	382620	10.00	ppbV	0.00	
4) 1,4-difluorobenzene	10.583	114	932389	10.00	ppbV	0.00	
11) chlorobenzene-D5	15.367	54	189947	10.00	ppbV	0.00	
Target Compounds							
							Qvalue
2) pentane	5.590	43	214695	6.73	ppbV		99
3) C5 - < C6 Aliphatics	5.590	TIC	2407785m	75.48	ppbV		
5) hexane	8.458	57	199482	5.62	ppbV		98
6) C6 - < C7 Aliphatics	10.583	TIC	10822137m	305.06	ppbV		
7) benzene	10.157	78	79671	1.37	ppbV		99
8) C1 - Benzenes	10.157	78	79671	1.37	ppbV		99
9) heptane	11.743	43	510576	10.90	ppbV		98
10) C7 - C8 Aliphatics	14.642	TIC	35322342m	754.41	ppbV		
12) toluene	13.517	91	1047525	15.77	ppbV		100
13) octane	14.642	85	670344	24.87	ppbV		99
14) ethylbenzene	15.758	91	781693	9.75	ppbV		97
15) m+p-xylene	15.917	91	2326858	36.06	ppbV		97
16) o-xylene	16.333	91	1096816	17.27	ppbV		97
17) C2-Benzenes	15.917	91	4221213m	66.46	ppbV		
18) nonane	16.542	43	2425977	37.59	ppbV		97
19) C9 - < C10 Aliphatics	16.542	TIC	85076998m	1318.14	ppbV		
20) 1,3,5-trimethylbenzene	17.450	105	590698	8.32	ppbV		98
21) 1,2,4-Trimethylbenzene	17.783	105	1571937	23.71	ppbV		99
22) C3-Benzenes	17.783	105	5340486m	80.56	ppbV		
23) decane	17.867	57	2777870	40.42	ppbV		98
24) C10 - < C11 Aliphatics	17.867	TIC	65099021m	947.26	ppbV		
25) undecane	18.850	57	1904516	25.72	ppbV		99
26) C11 - < C12 Aliphatics	18.850	TIC	37309837m	503.79	ppbV		
27) 1,2,4,5-tetramethylben...	19.083	119	152071	4.46	ppbV		97
28) C4-Benzenes	18.450	134	1168295m	34.23	ppbV		
29) C5-Benzenes	18.892	148	256410m	7.51	ppbV		
30) dodecane	19.692	57	359344	5.47	ppbV		99
31) C12 + Aliphatics	19.692	TIC	12717031m	193.53	ppbV		

(#) = qualifier out of range (m) = manual integration (+) = signals summed

Data Path : C:\Projects\Hawaii DOH\2. Laboratory Data\Alpha\WAF Study\L2321418\TO15-LL\NF TO-15\  
 Data File : r1922260.D  
 Acq On : 12 May 2023 3:07 AM  
 Operator : AIRLAB19:TJS  
 Sample : L2321418-02D,3,0.5,250  
 Misc : WG1777877,ICAL19974  
 ALS Vial : 0 Sample Multiplier: 1

Quant Time: Jun 06 12:38:38 2023  
 Quant Method : C:\Projects\Hawaii DOH\2. Laboratory Data\Alpha\WAF Study\L2321418\TO15-LL\NF TO-15\  
 ... 5\TFS19 230501 NF.M  
 Quant Title : TO-14A/TO-15 SIM/Full Scan Analysis  
 QLast Update : Tue Jun 06 11:57:14 2023  
 Response via : Initial Calibration

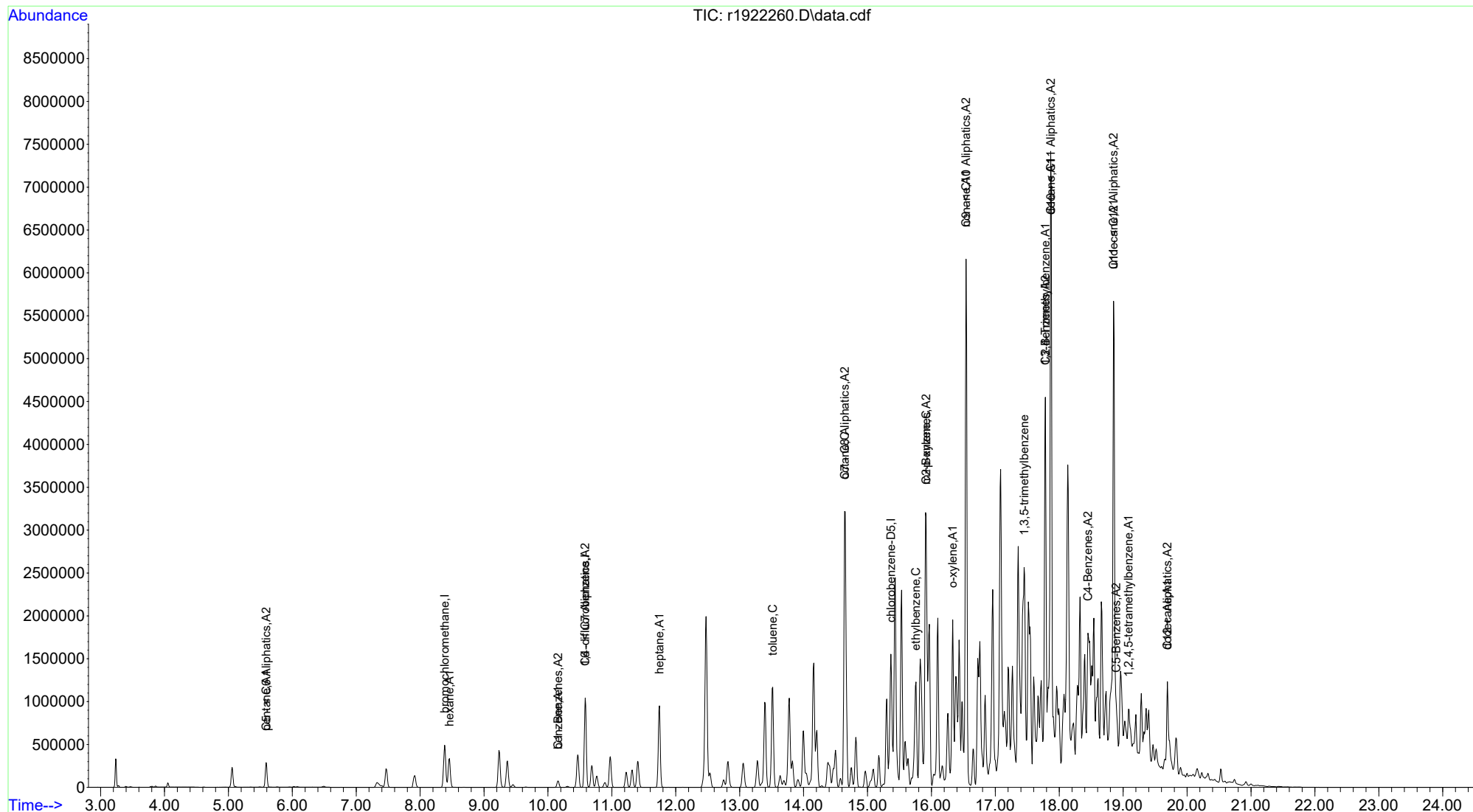

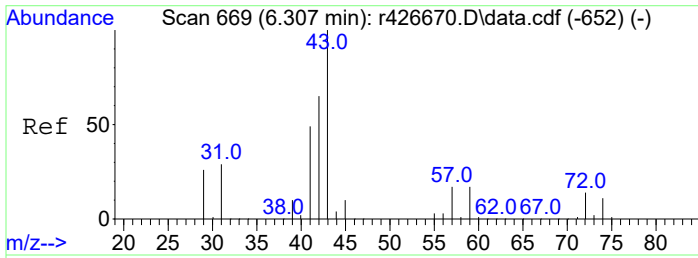

#2  
 pentane  
 Concen: 6.73 ppbV  
 RT: 5.590 min Scan# 592  
 Delta R.T. 0.000 min  
 Lab File: r1922260.D  
 Acq: 12 May 2023 3:07 AM

Tgt Ion	Resp	Lower	Upper
43	100		
57	14.9	11.4	17.0
72	11.1	8.6	13.0

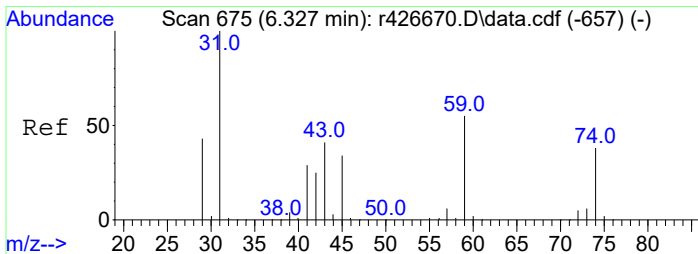
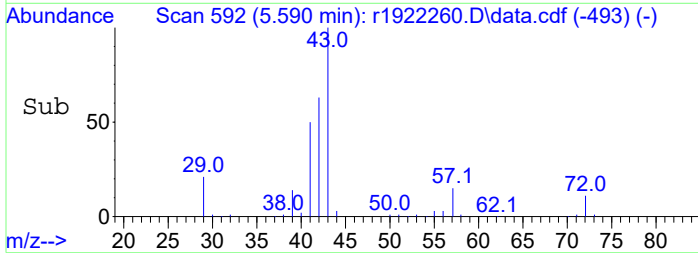
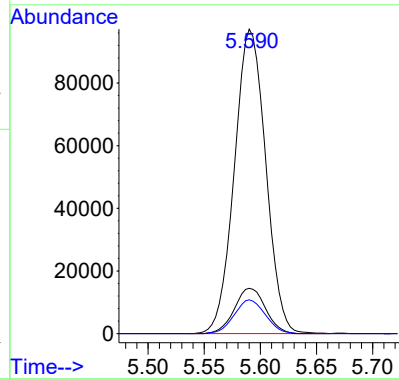
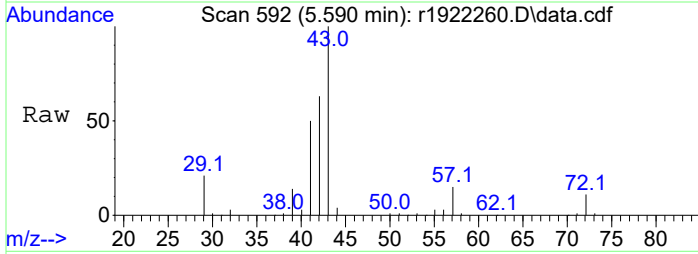

#3  
 C5 - < C6 Aliphatics  
 Concen: 75.48 ppbV m  
 RT: 5.590 min Scan# 592  
 Delta R.T. 0.000 min  
 Lab File: r1922260.D  
 Acq: 12 May 2023 3:07 AM

Tgt Ion	Resp	Lower	Upper
TIC	100		
59	0.0	0.0	0.0
45	0.0	0.0	0.0

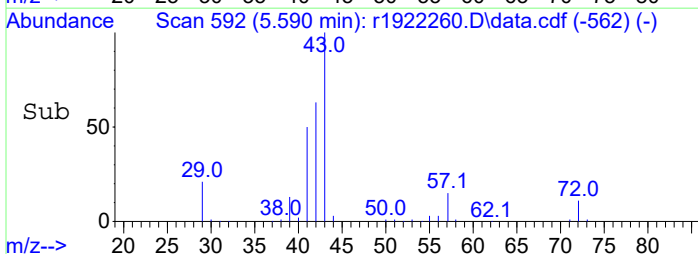
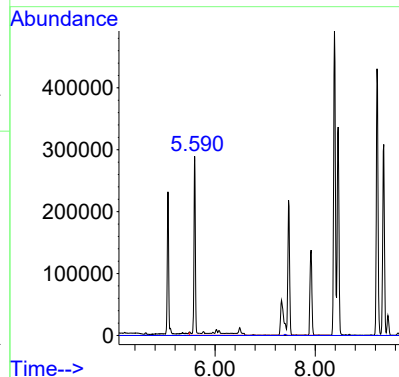
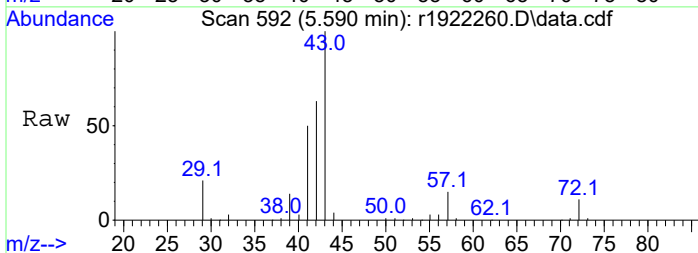

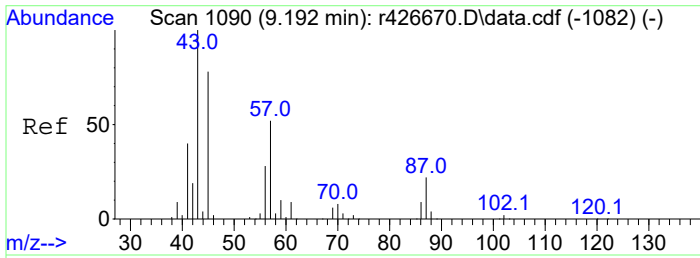

#5  
 hexane  
 Concen: 5.62 ppbV  
 RT: 8.458 min Scan# 984  
 Delta R.T. 0.000 min  
 Lab File: r1922260.D  
 Acq: 12 May 2023 3:07 AM

Tgt Ion	Resp	Lower	Upper
57	100		
43	67.7	55.8	83.6
86	16.9	14.2	21.2

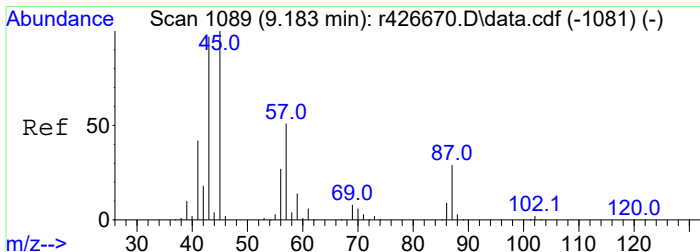
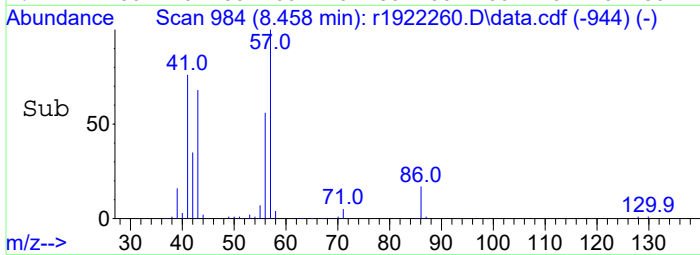
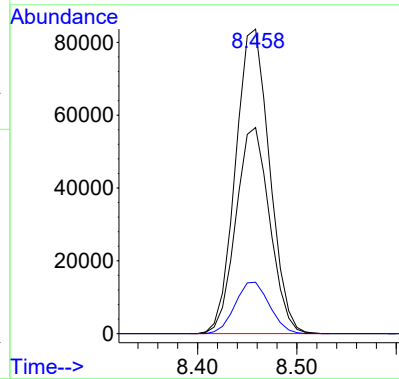
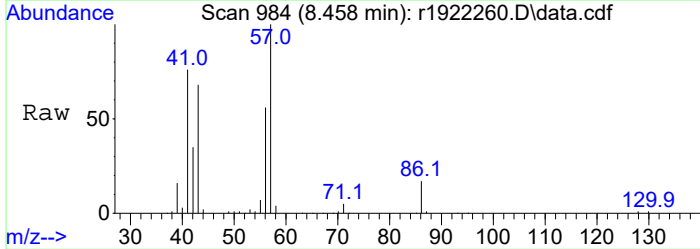

#6  
 C6 - < C7 Aliphatics  
 Concen: 305.06 ppbV m  
 RT: 10.583 min Scan# 1262  
 Delta R.T. 0.000 min  
 Lab File: r1922260.D  
 Acq: 12 May 2023 3:07 AM

Tgt Ion	Resp	Lower	Upper
TIC	100		
59	0.0	0.0	0.0
45	175900.0	14.5	21.7#

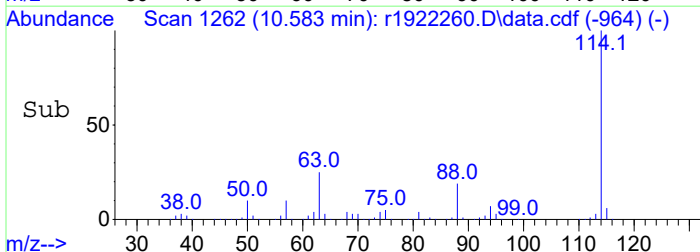
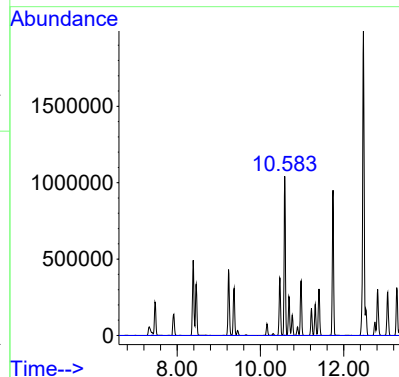
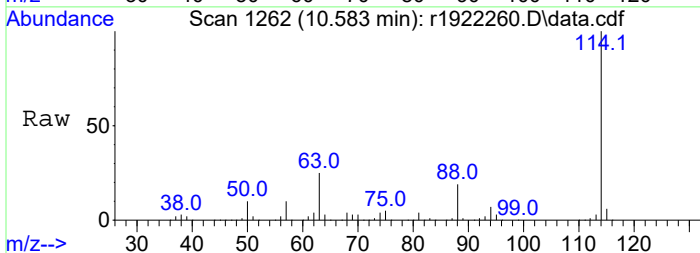

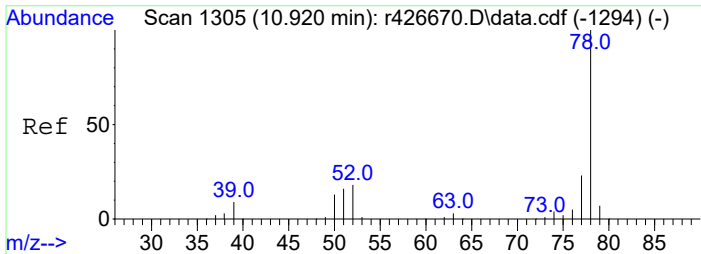

#7  
benzene  
Concen: 1.37 ppbV  
RT: 10.157 min Scan# 1198  
Delta R.T. 0.000 min  
Lab File: r1922260.D  
Acq: 12 May 2023 3:07 AM

Tgt Ion	Resp	Lower	Upper
78	100		
52	18.9	14.9	22.3

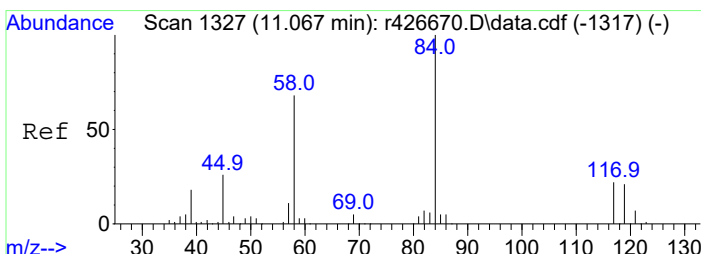
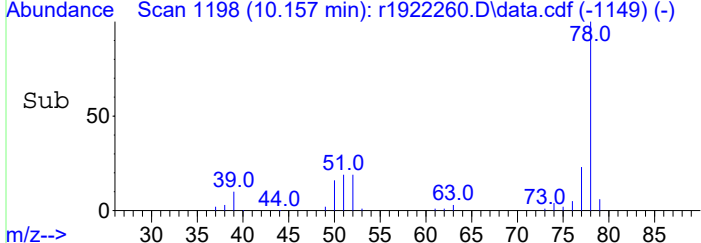
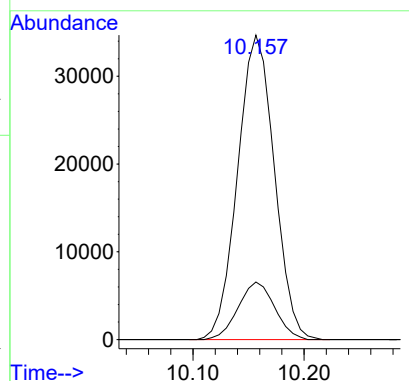
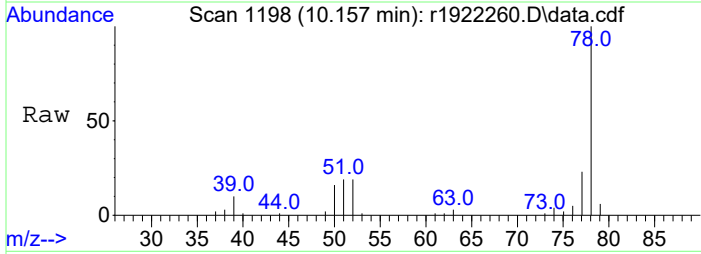

#8  
C1 - Benzenes  
Concen: 1.37 ppbV  
RT: 10.157 min Scan# 1198  
Delta R.T. 0.000 min  
Lab File: r1922260.D  
Acq: 12 May 2023 3:07 AM

Tgt Ion	Resp	Lower	Upper
78	100		
52	18.9	14.9	22.3

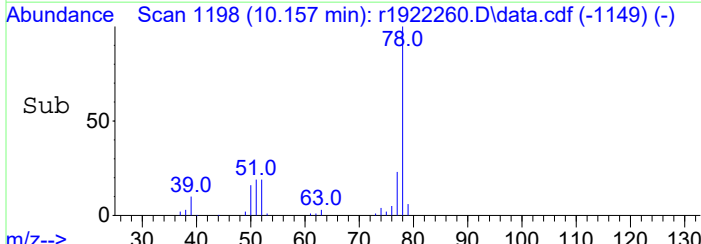
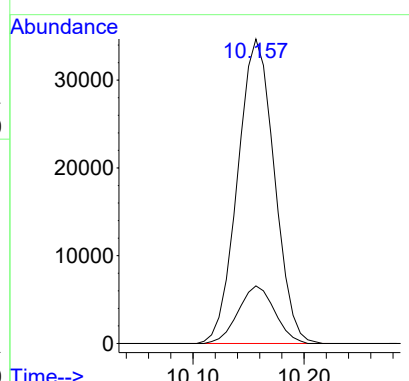
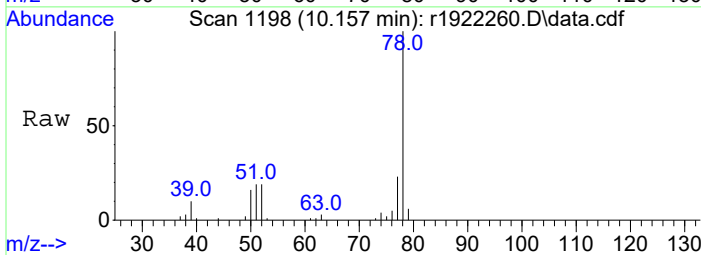

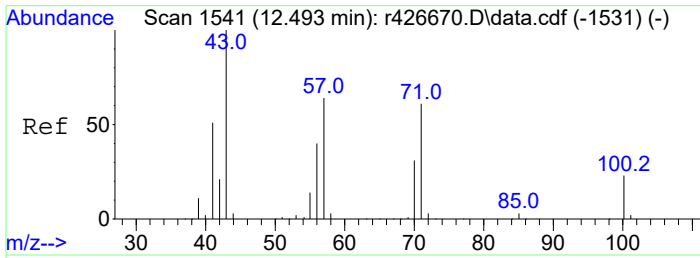

#9  
 heptane  
 Concen: 10.90 ppbV  
 RT: 11.743 min Scan# 1436  
 Delta R.T. 0.000 min  
 Lab File: r1922260.D  
 Acq: 12 May 2023 3:07 AM

Tgt Ion:	Resp:	Lower	Upper
43	510576		
57	48.9	37.9	56.9
100	17.6	13.4	20.2

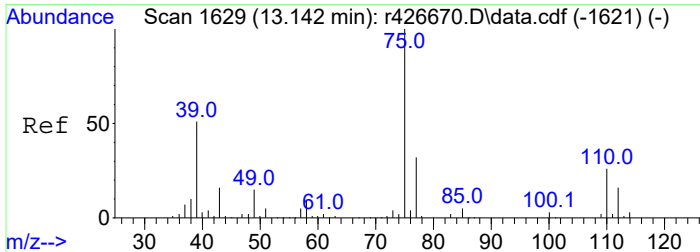
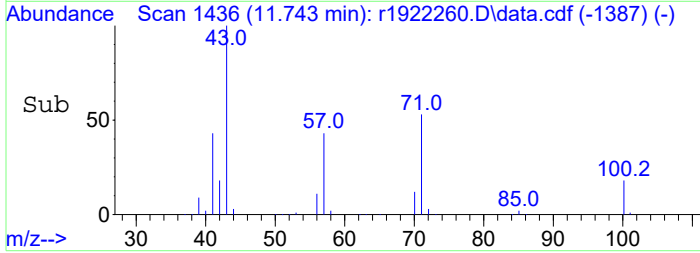
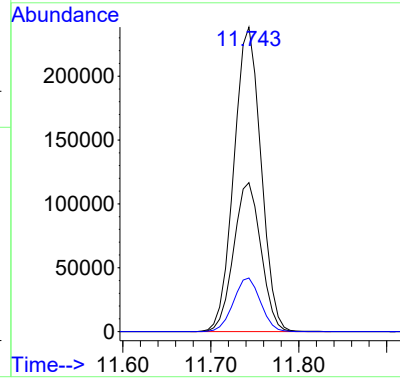
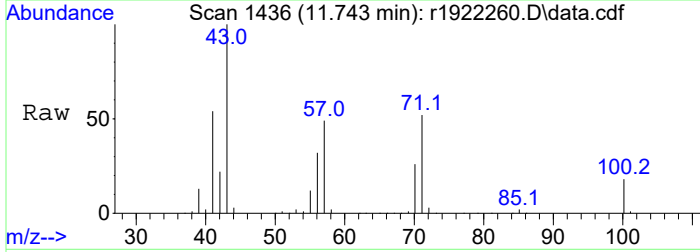

#10  
 C7 - C8 Aliphatics  
 Concen: 754.41 ppbV m  
 RT: 14.642 min Scan# 1790  
 Delta R.T. -0.008 min  
 Lab File: r1922260.D  
 Acq: 12 May 2023 3:07 AM

Tgt Ion:	Resp:	Lower	Upper
TIC	100		
39	8543400.0	227.8	341.8#
77	130200.0	5.8	8.6#

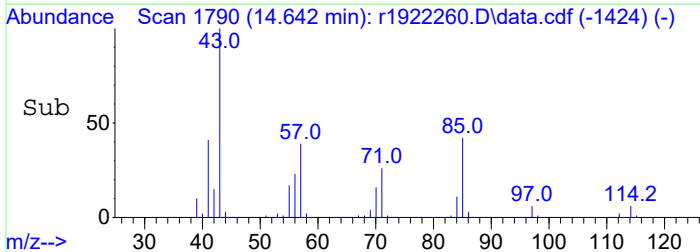
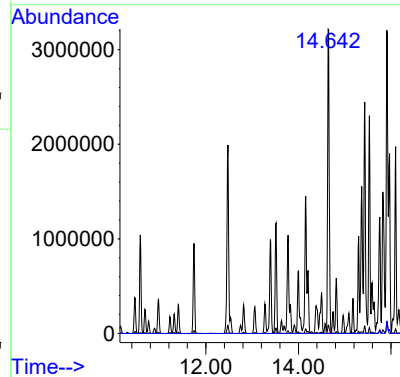
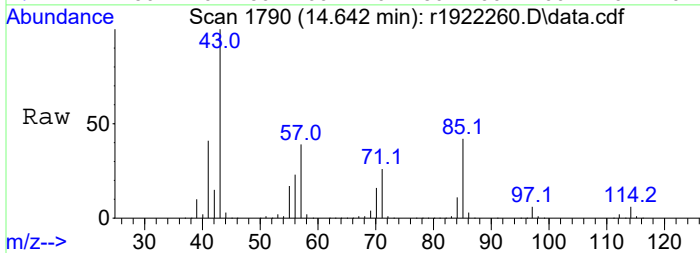

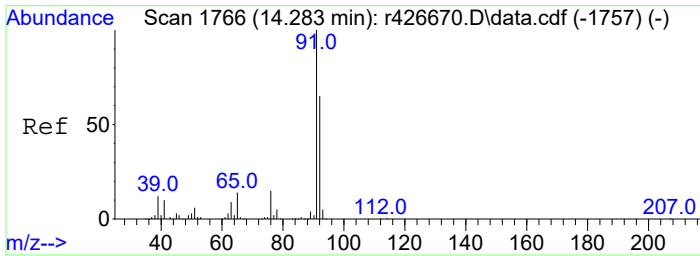

#12  
toluene  
Concen: 15.77 ppbV  
RT: 13.517 min Scan# 1655  
Delta R.T. 0.000 min  
Lab File: r1922260.D  
Acq: 12 May 2023 3:07 AM

Tgt Ion: 91 Resp: 1047525  
Ion Ratio Lower Upper  
91 100  
92 63.4 51.0 76.4

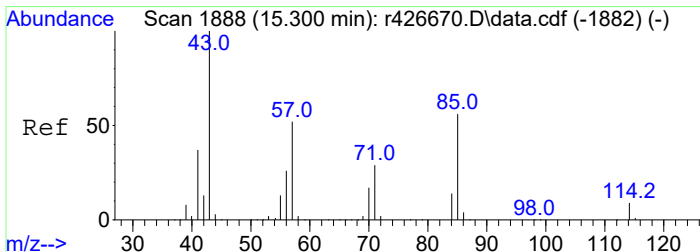
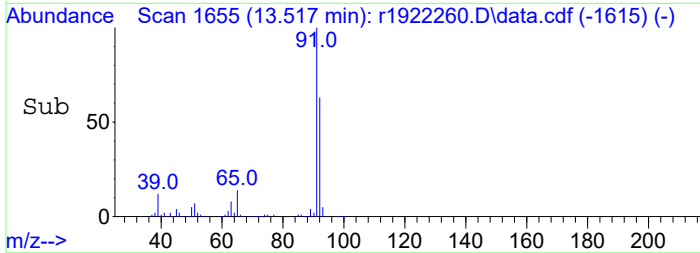
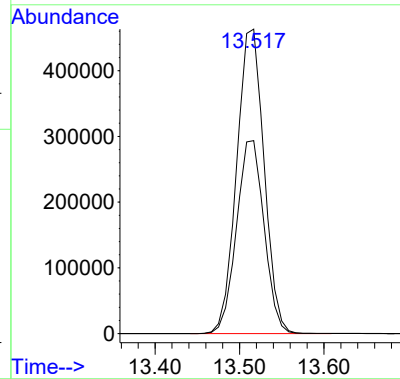
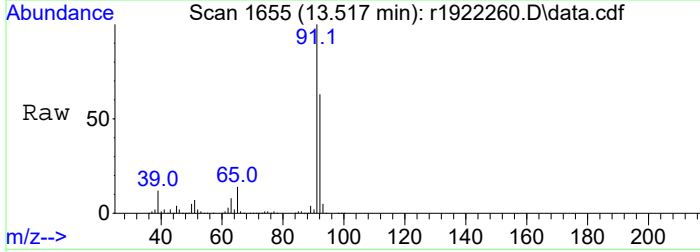

#13  
octane  
Concen: 24.87 ppbV  
RT: 14.642 min Scan# 1790  
Delta R.T. 0.000 min  
Lab File: r1922260.D  
Acq: 12 May 2023 3:07 AM

Tgt Ion: 85 Resp: 670344  
Ion Ratio Lower Upper  
85 100  
57 93.6 73.2 109.8  
114 15.1 11.4 17.0  
43 237.0 190.0 285.0

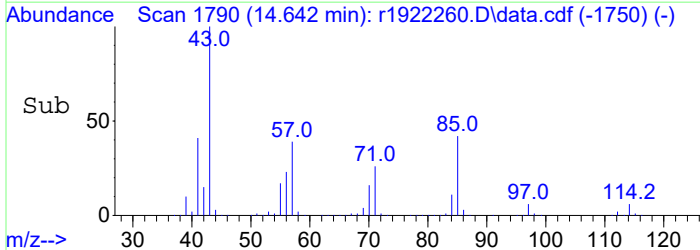
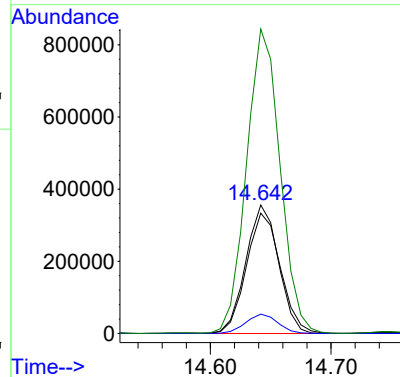
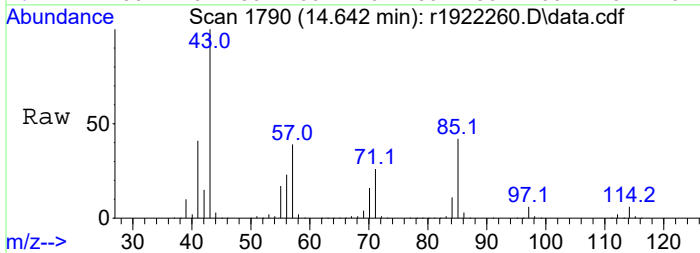



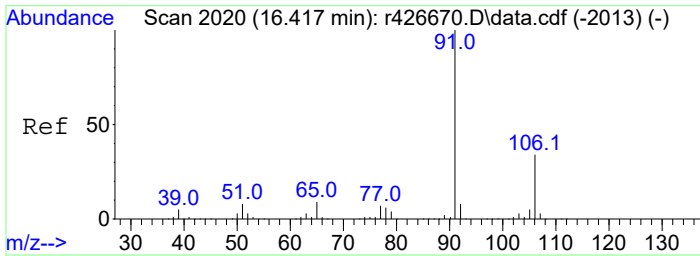

#14  
ethylbenzene  
Concen: 9.75 ppbV  
RT: 15.758 min Scan# 1922  
Delta R.T. 0.000 min  
Lab File: r1922260.D  
Acq: 12 May 2023 3:07 AM

Tgt Ion: 91 Resp: 781693  
Ion Ratio Lower Upper  
91 100  
106 34.0 25.9 38.9

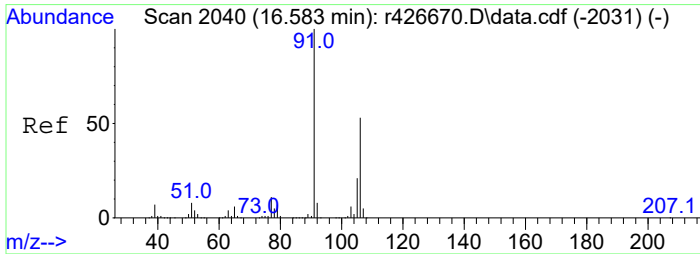
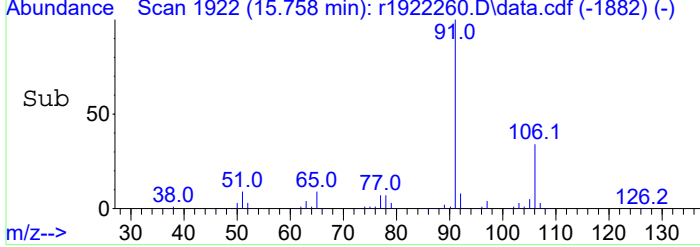
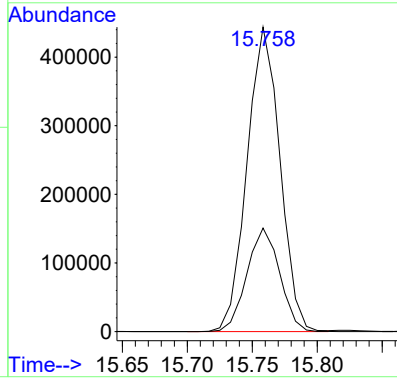
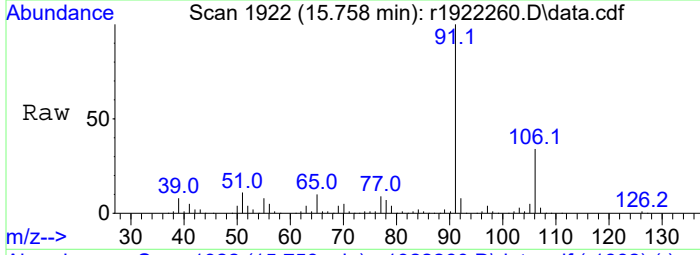

#15  
m+p-xylene  
Concen: 36.06 ppbV  
RT: 15.917 min Scan# 1941  
Delta R.T. 0.008 min  
Lab File: r1922260.D  
Acq: 12 May 2023 3:07 AM

Tgt Ion: 91 Resp: 2326858  
Ion Ratio Lower Upper  
91 100  
106 53.0 40.6 61.0

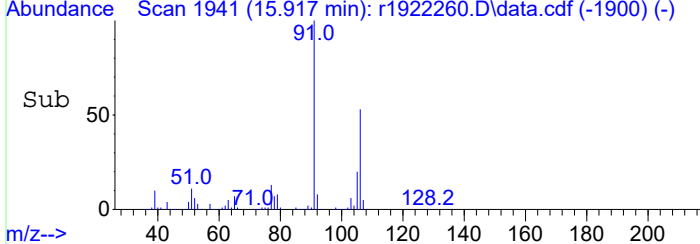
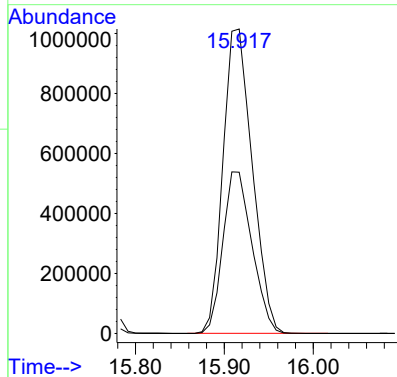
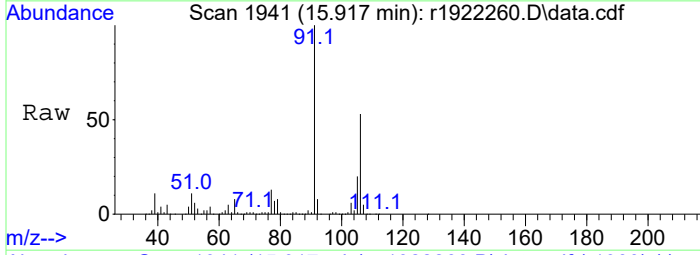

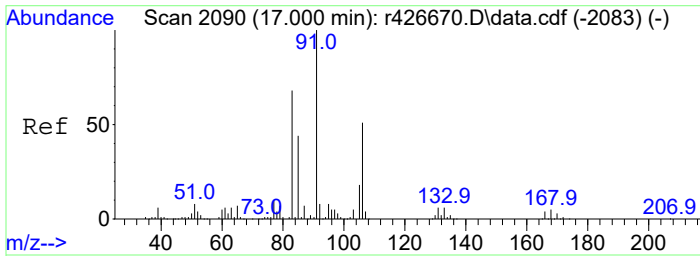

#16  
 o-xylene  
 Concen: 17.27 ppbV  
 RT: 16.333 min Scan# 1991  
 Delta R.T. 0.000 min  
 Lab File: r1922260.D  
 Acq: 12 May 2023 3:07 AM

Tgt Ion: 91 Resp: 1096816  
 Ion Ratio Lower Upper  
 91 100  
 106 49.7 38.2 57.4

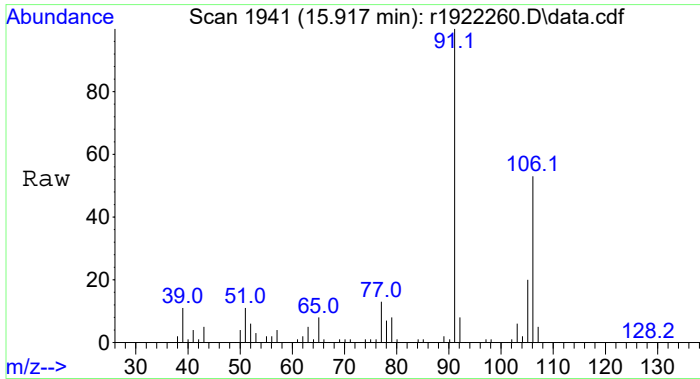
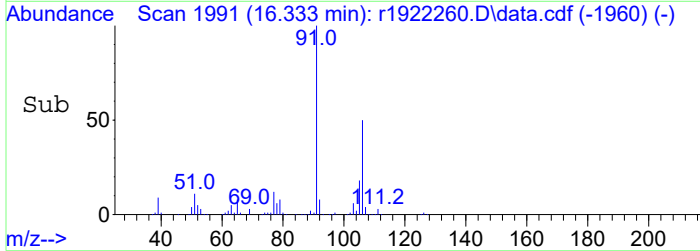
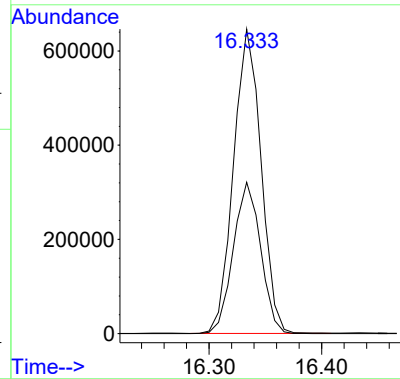
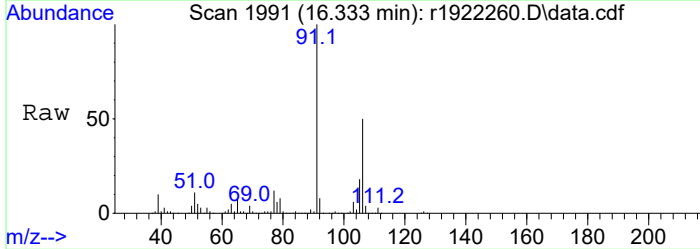

#17  
 C2-Benzenes  
 Concen: 66.46 ppbV m  
 RT: 15.917 min Scan# 1941  
 Delta R.T. 0.008 min  
 Lab File: r1922260.D  
 Acq: 12 May 2023 3:07 AM

Tgt Ion: 91 Resp: 4221213  
 Ion Ratio Lower Upper  
 91 100  
 106 53.0 40.6 61.0

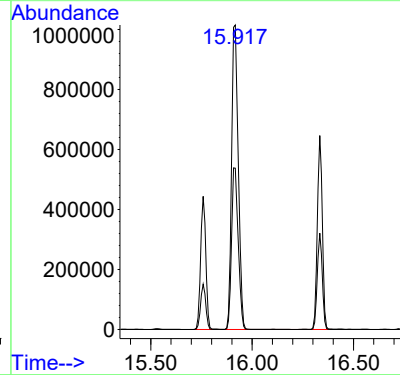
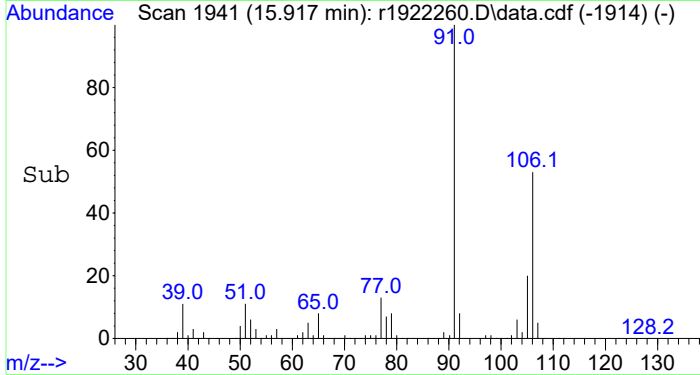

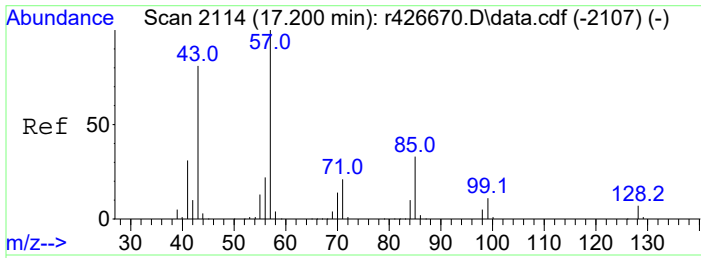

#18  
 nonane  
 Concen: 37.59 ppbV  
 RT: 16.542 min Scan# 2016  
 Delta R.T. 0.000 min  
 Lab File: r1922260.D  
 Acq: 12 May 2023 3:07 AM

Tgt Ion: 43 Resp: 2425977

Ion	Ratio	Lower	Upper
43	100		
57	91.8	70.7	106.1
128	6.5	5.0	7.4

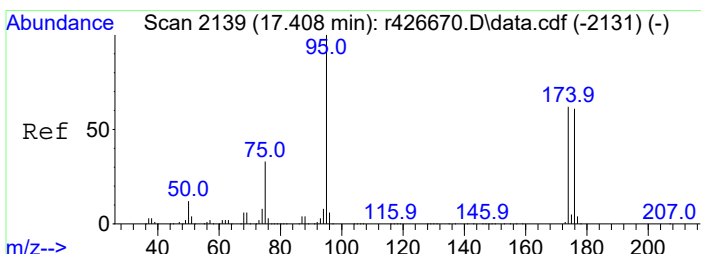
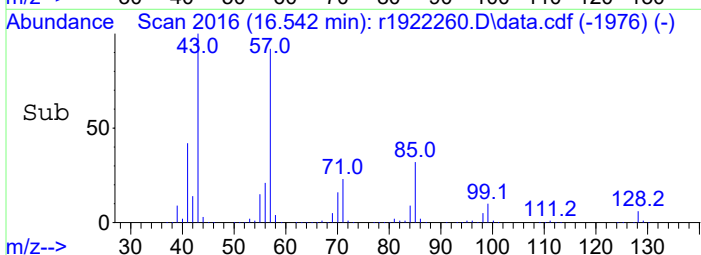
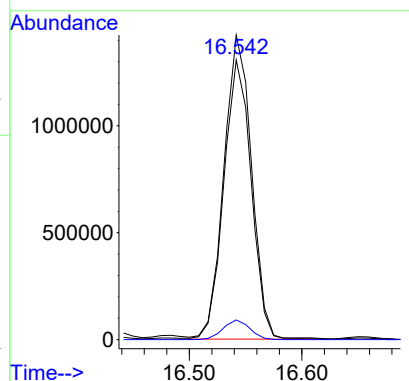
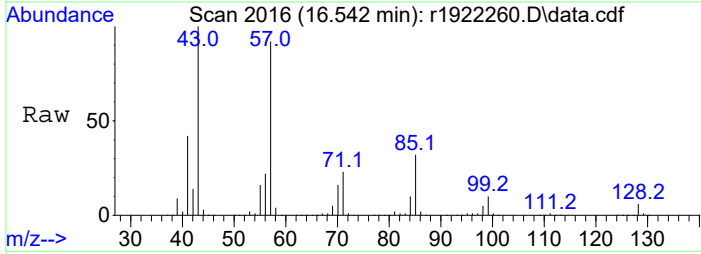

#19  
 C9 - < C10 Aliphatics  
 Concen: 1318.14 ppbV m  
 RT: 16.542 min Scan# 2016  
 Delta R.T. 0.000 min  
 Lab File: r1922260.D  
 Acq: 12 May 2023 3:07 AM

Tgt Ion:TIC Resp:85076998

Ion	Ratio	Lower	Upper
TIC	100		
174	0.0	0.0	0.0
75	0.0	0.0	0.0

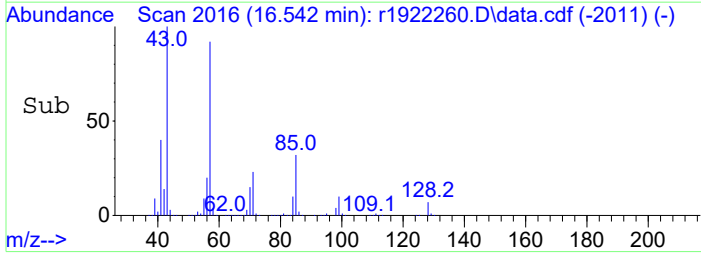
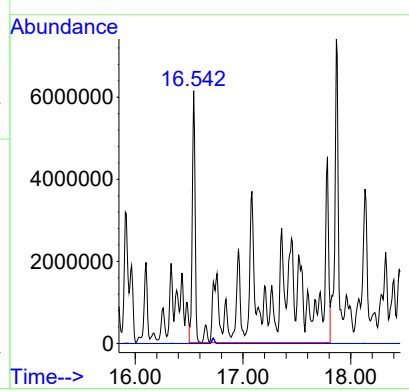
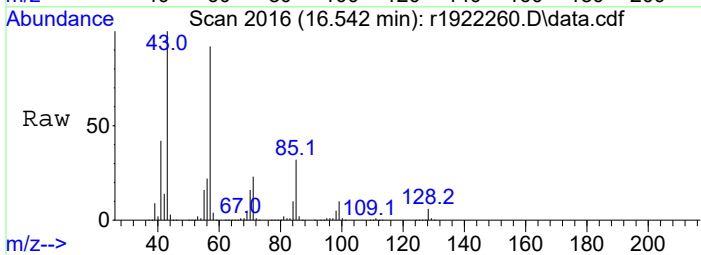

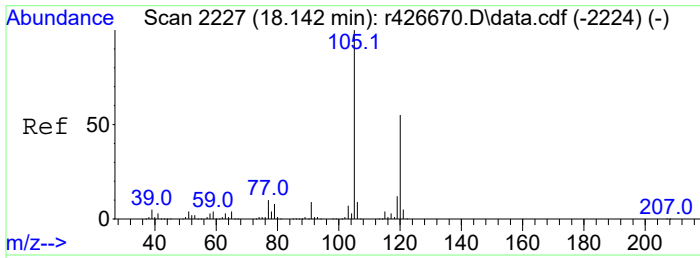

#20  
 1,3,5-trimethylbenzene  
 Concen: 8.32 ppbV  
 RT: 17.450 min Scan# 2125  
 Delta R.T. 0.000 min  
 Lab File: r1922260.D  
 Acq: 12 May 2023 3:07 AM

Tgt Ion	Resp	Lower	Upper
105	590698		
105	100		
120	48.8	40.6	60.8
91	10.2	8.6	13.0

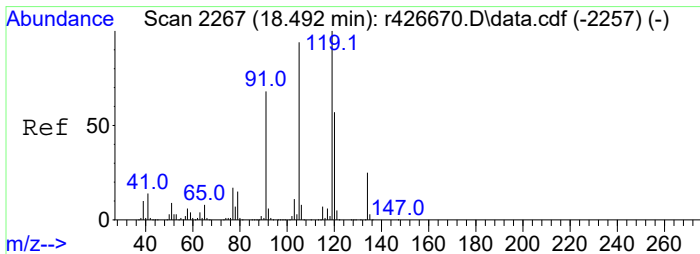
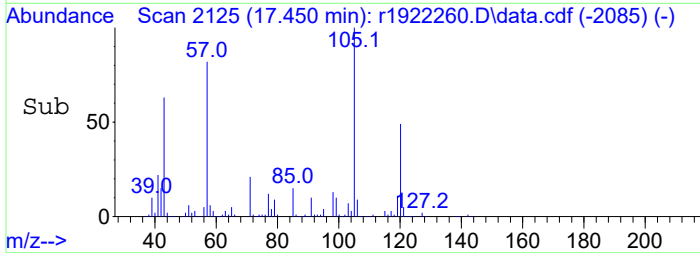
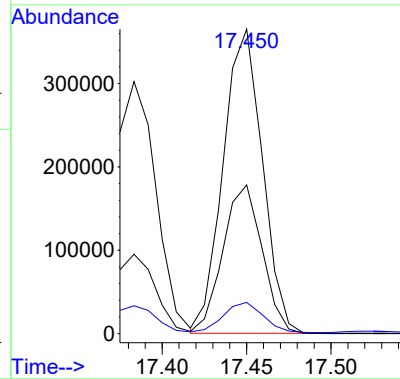
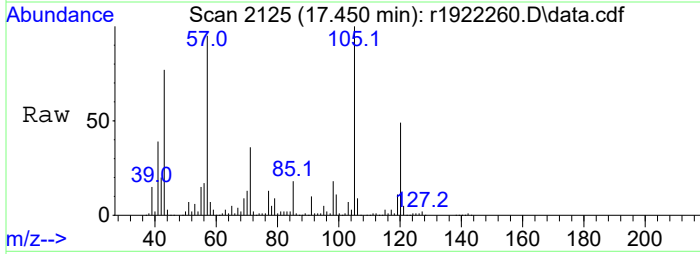

#21  
 1,2,4-Trimethylbenzene  
 Concen: 23.71 ppbV  
 RT: 17.783 min Scan# 2163  
 Delta R.T. 0.000 min  
 Lab File: r1922260.D  
 Acq: 12 May 2023 3:07 AM

Tgt Ion	Resp	Lower	Upper
105	1571937		
105	100		
120	47.4	38.2	57.2
91	10.9	9.2	13.8

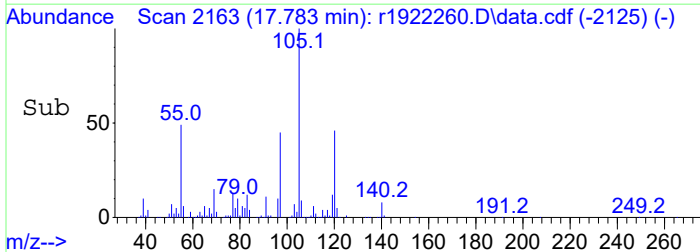
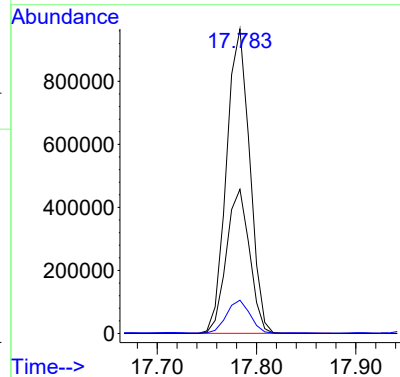
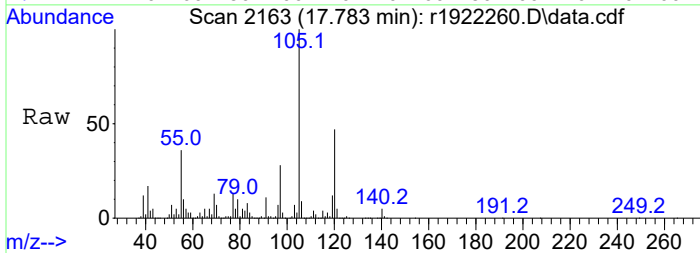

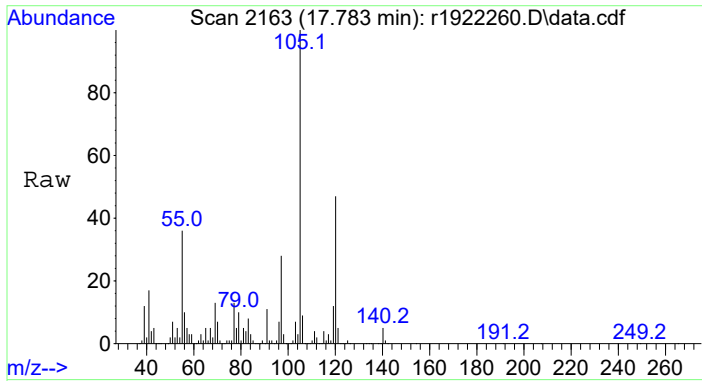

#22  
 C3-Benzenes  
 Concen: 80.56 ppbV m  
 RT: 17.783 min Scan# 2163  
 Delta R.T. 0.000 min  
 Lab File: r1922260.D  
 Acq: 12 May 2023 3:07 AM

Tgt Ion	Ratio	Lower	Upper
105	100		
120	13.9	38.2	57.2#
91	3.2	9.2	13.8#

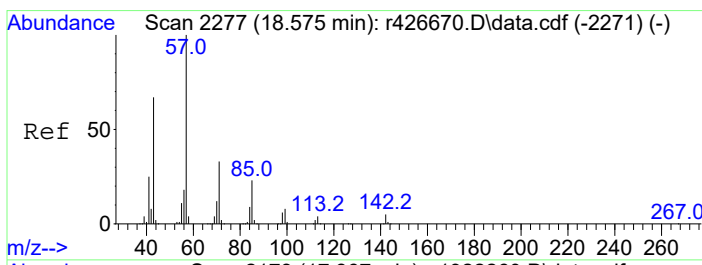
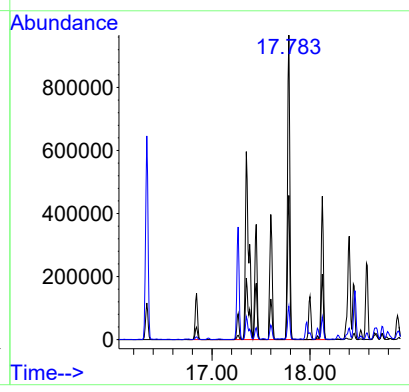
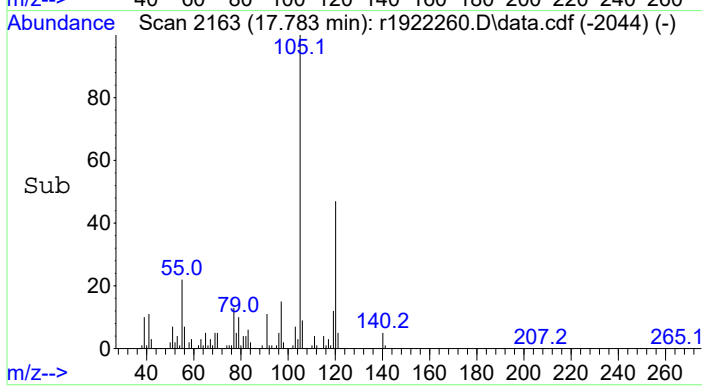

#23  
 decane  
 Concen: 40.42 ppbV  
 RT: 17.867 min Scan# 2173  
 Delta R.T. 0.000 min  
 Lab File: r1922260.D  
 Acq: 12 May 2023 3:07 AM

Tgt Ion	Ratio	Lower	Upper
57	100		
43	89.5	73.6	110.4
142	5.4	4.2	6.4

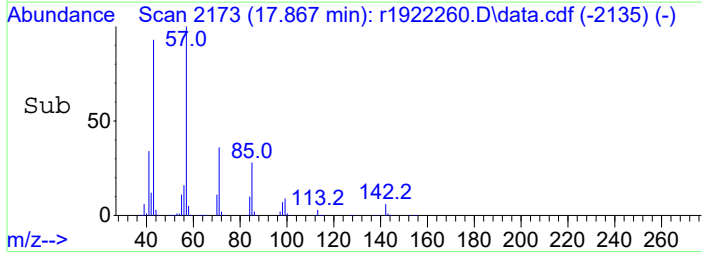
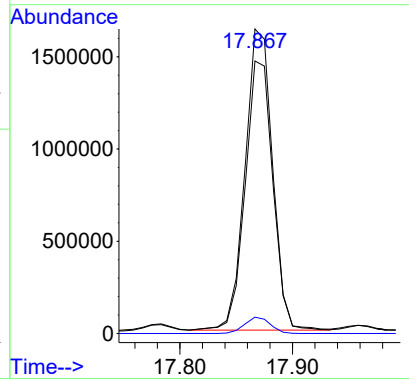
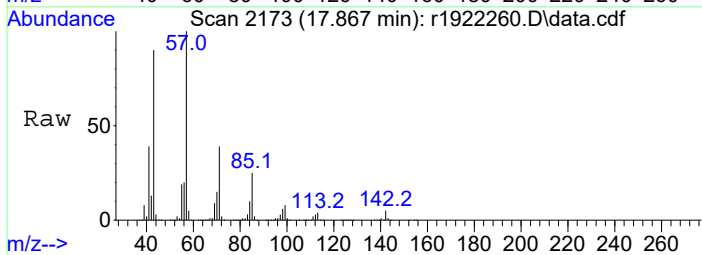

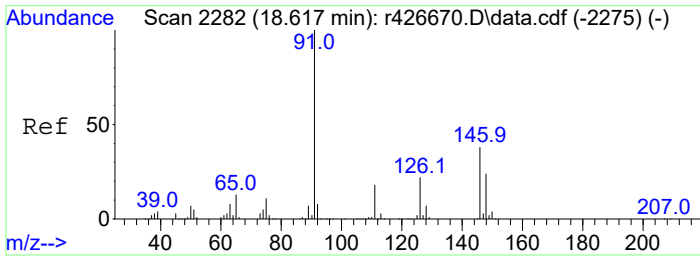

#24  
 C10 - < C11 Aliphatics  
 Concen: 947.26 ppbV m  
 RT: 17.867 min Scan# 2173  
 Delta R.T. 0.000 min  
 Lab File: r1922260.D  
 Acq: 12 May 2023 3:07 AM

Tgt Ion:TIC Resp:65099021  
 Ion Ratio Lower Upper  
 TIC 100  
 126 178600.0 2.2 3.2#

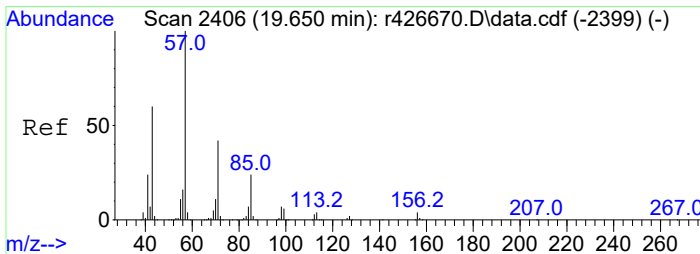
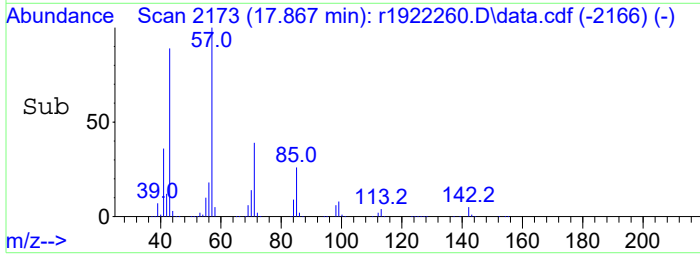
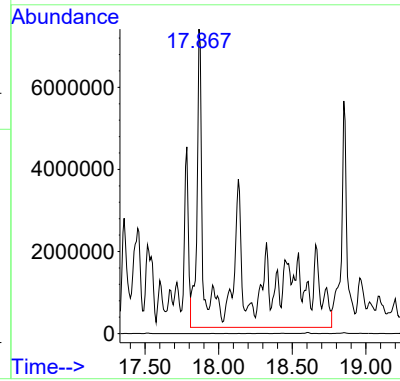
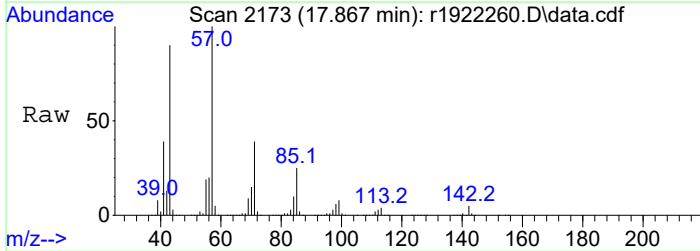

#25  
 undecane  
 Concen: 25.72 ppbV  
 RT: 18.850 min Scan# 2291  
 Delta R.T. 0.000 min  
 Lab File: r1922260.D  
 Acq: 12 May 2023 3:07 AM

Tgt Ion: 57 Resp: 1904516  
 Ion Ratio Lower Upper  
 57 100  
 43 81.7 66.9 100.3  
 71 47.3 37.5 56.3  
 156 4.1 3.2 4.8

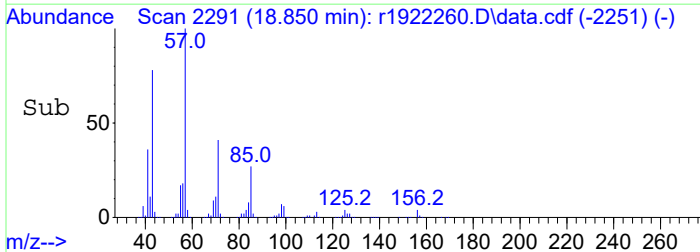
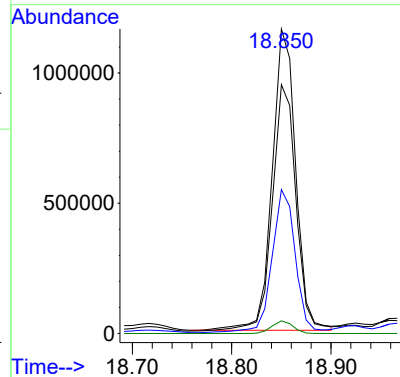
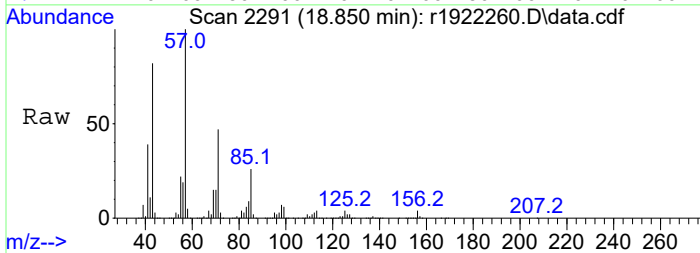

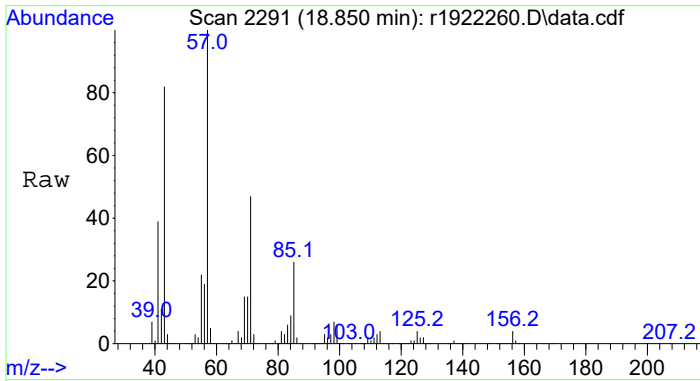

#26  
 C11 - < C12 Aliphatics  
 Concen: 503.79 ppbV m  
 RT: 18.850 min Scan# 2291  
 Delta R.T. 0.000 min  
 Lab File: r1922260.D  
 Acq: 12 May 2023 3:07 AM  
 Tgt Ion:TIC Resp:37309837

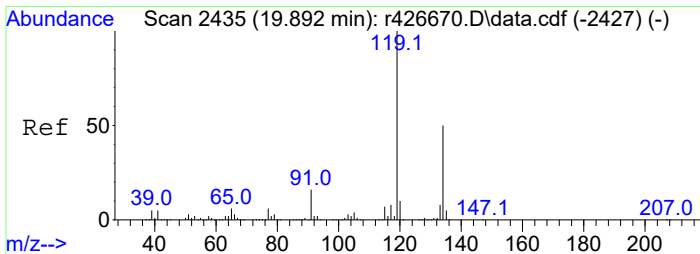
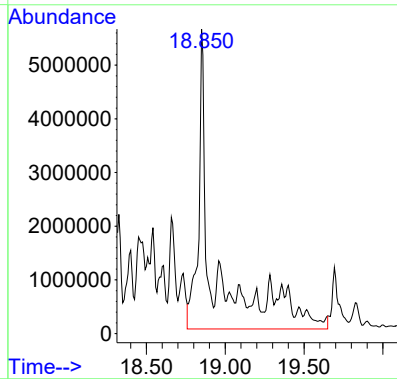
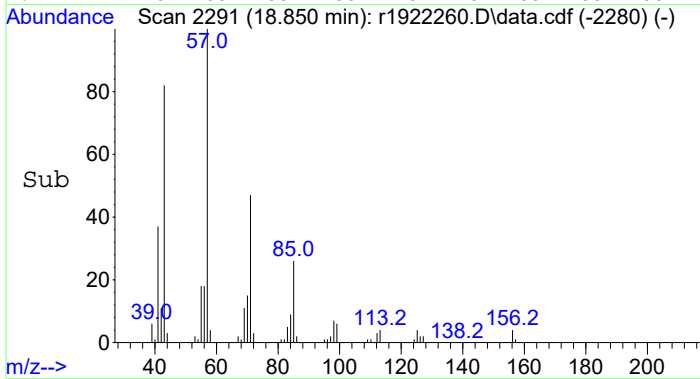

#27  
 1,2,4,5-tetramethylbenzene  
 Concen: 4.46 ppbV  
 RT: 19.083 min Scan# 2319  
 Delta R.T. 0.000 min  
 Lab File: r1922260.D  
 Acq: 12 May 2023 3:07 AM

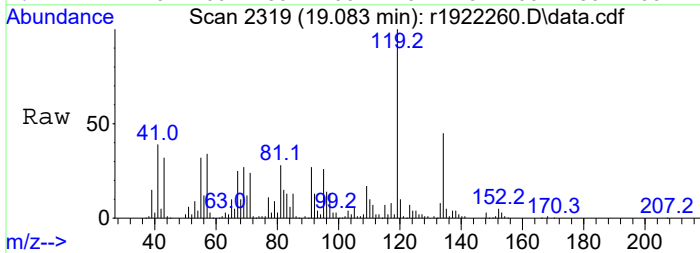

Tgt Ion:119 Resp: 152071

Ion	Ratio	Lower	Upper
119	100		
134	44.7	37.8	56.6
91	26.8	22.2	33.4

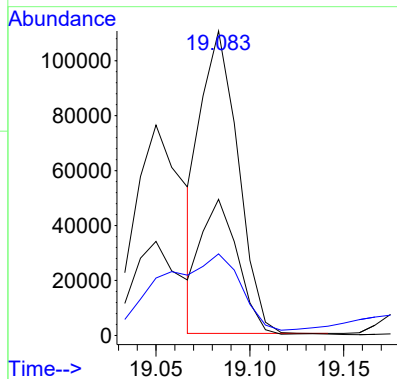
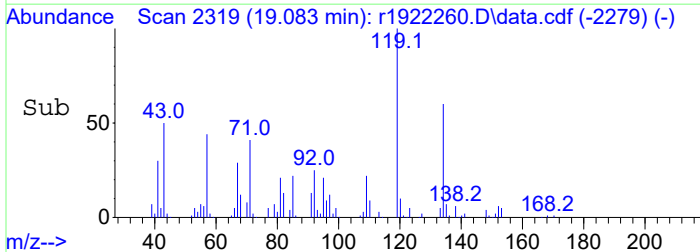

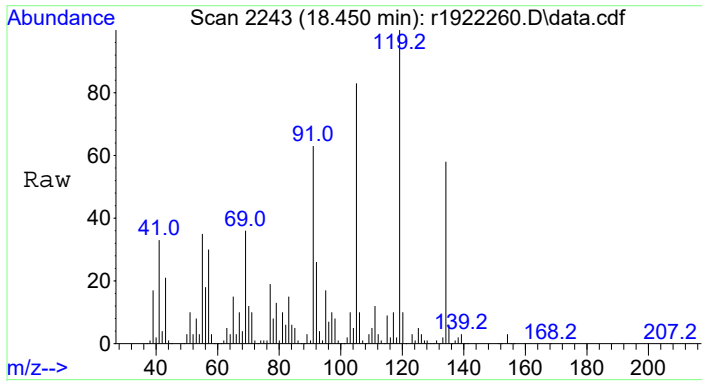

#28  
 C4-Benzenes  
 Concen: 34.23 ppbV m  
 RT: 18.450 min Scan# 2243  
 Delta R.T. 0.000 min  
 Lab File: r1922260.D  
 Acq: 12 May 2023 3:07 AM

Tgt Ion	Resp	Lower	Upper
134	100		
120	2.7	13.4	20.2#
91	22.9	93.0	139.6#

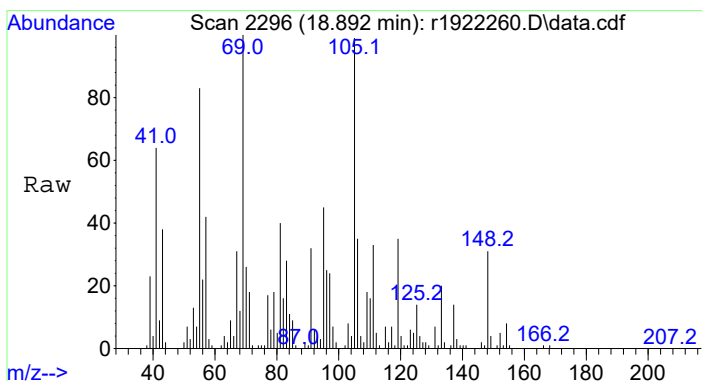
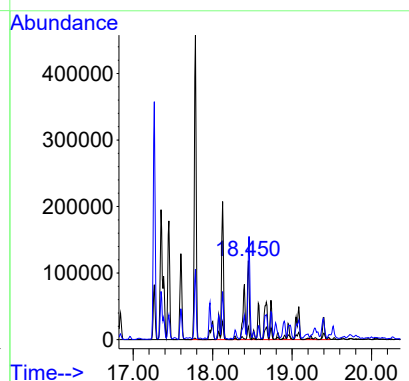
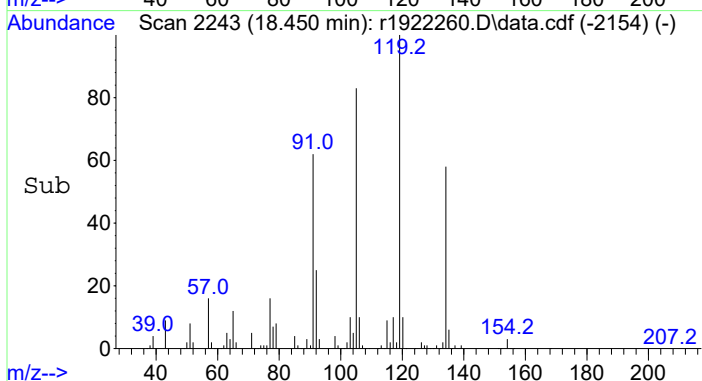

#29  
 C5-Benzenes  
 Concen: 7.51 ppbV m  
 RT: 18.892 min Scan# 2296  
 Delta R.T. 0.000 min  
 Lab File: r1922260.D  
 Acq: 12 May 2023 3:07 AM

Tgt Ion	Resp	Lower	Upper
148	100		
134	1.1	6.0	9.0#
91	21.0	88.3	132.5#

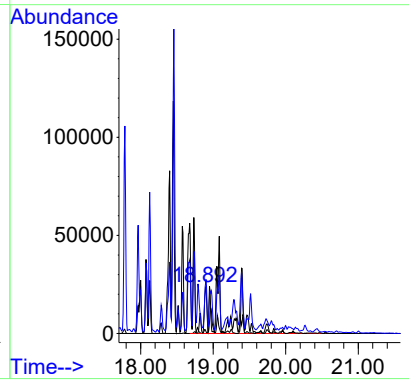
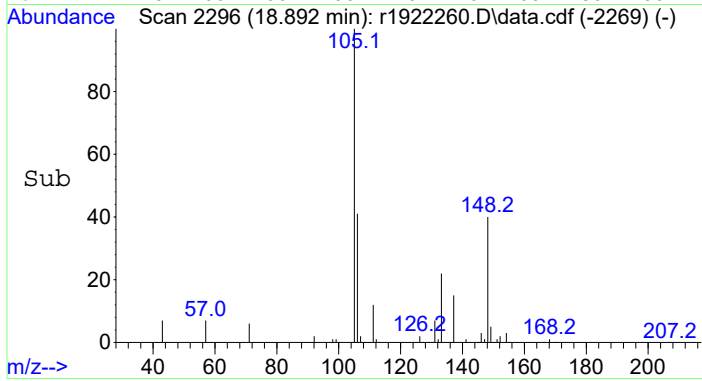



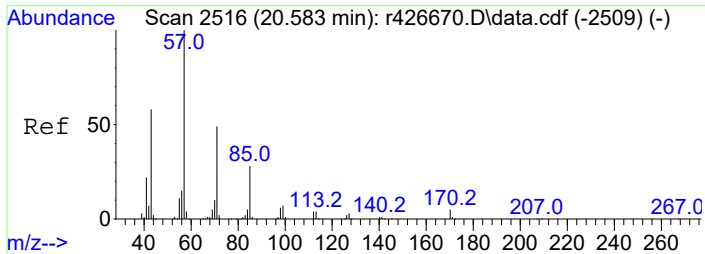

#30  
 dodecane  
 Concen: 5.47 ppbV  
 RT: 19.692 min Scan# 2390  
 Delta R.T. 0.000 min  
 Lab File: r1922260.D  
 Acq: 12 May 2023 3:07 AM

Tgt Ion: 57 Resp: 359344  
 Ion Ratio Lower Upper  
 57 100  
 43 78.6 63.6 95.4

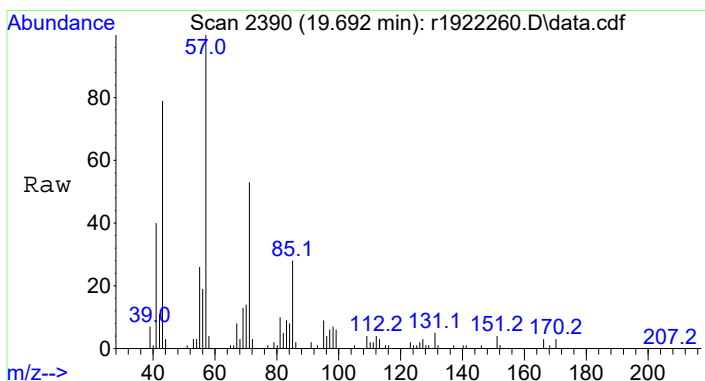
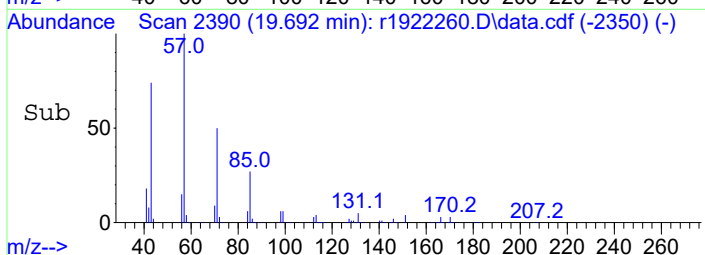
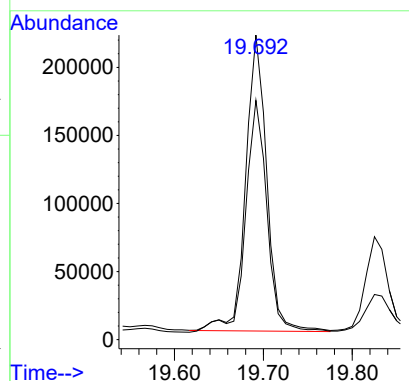
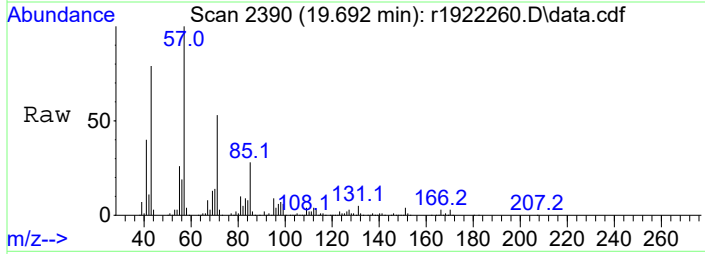

#31  
 C12 + Aliphatics  
 Concen: 193.53 ppbV m  
 RT: 19.692 min Scan# 2390  
 Delta R.T. 0.000 min  
 Lab File: r1922260.D  
 Acq: 12 May 2023 3:07 AM

Tgt Ion:TIC Resp:12717031

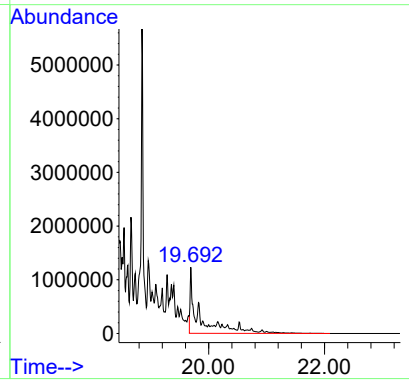
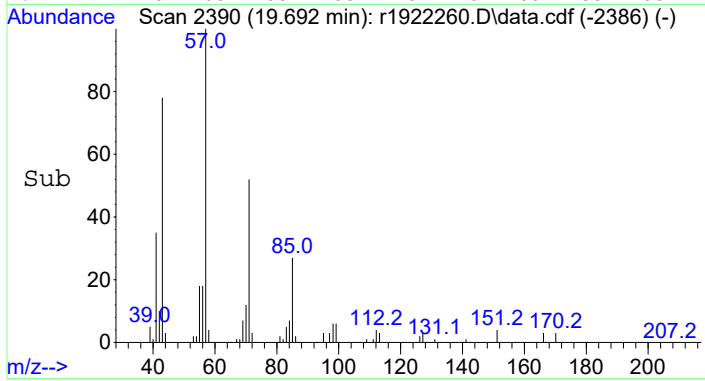

# EPA Method 8270E: Detailed Quant Reports Additive and Dispersant Analysis

Data Path : C:\Projects\Hawaii DOH\2. Laboratory Data\Alpha\WAF Study\L2317027\FULLSCAN\  
 Data File : F206052309.D  
 Acq On : 5 Jun 2023 6:59 pm  
 Operator : PAH2:DP  
 Sample : L2317027-01  
 Misc :  
 ALS Vial : 8 Sample Multiplier: 1

Quant Time: Jun 07 13:20:38 2023  
 Quant Method : C:\Projects\Hawaii DOH\2. Laboratory Data\Alpha\WAF Study\L2317027\FULLSCAN\Additi  
 ves.20230607.M  
 Quant Title : PIANO VOLATILES  
 QLast Update : Wed Jun 07 13:20:10 2023  
 Response via : Initial Calibration

Compound	R.T.	QIon	Response	Conc	Units	Dev(Min)
-----						
Target Compounds						Qvalue
1) 2(2-methoxyethoxy)-eth...	12.585	45	3540779	20843.32	ug/L	# 100
-----						

(#) = qualifier out of range (m) = manual integration (+) = signals summed

Data Path : C:\Projects\Hawaii DOH\2. Laboratory Data\Alpha\WAF Study\L2317027\FULLSCAN\  
Data File : F206052309.D  
Acq On : 5 Jun 2023 6:59 pm  
Operator : PAH2:DP  
Sample : L2317027-01  
Misc :  
ALS Vial : 8 Sample Multiplier: 1

Quant Time: Jun 07 13:20:38 2023  
Quant Method : C:\Projects\Hawaii DOH\2. Laboratory Data\Alpha\WAF Study\L2317027\FULLSCAN\Additi  
... ves.20230607.M  
Quant Title : PIANO VOLATILES  
QLast Update : Wed Jun 07 13:20:10 2023  
Response via : Initial Calibration

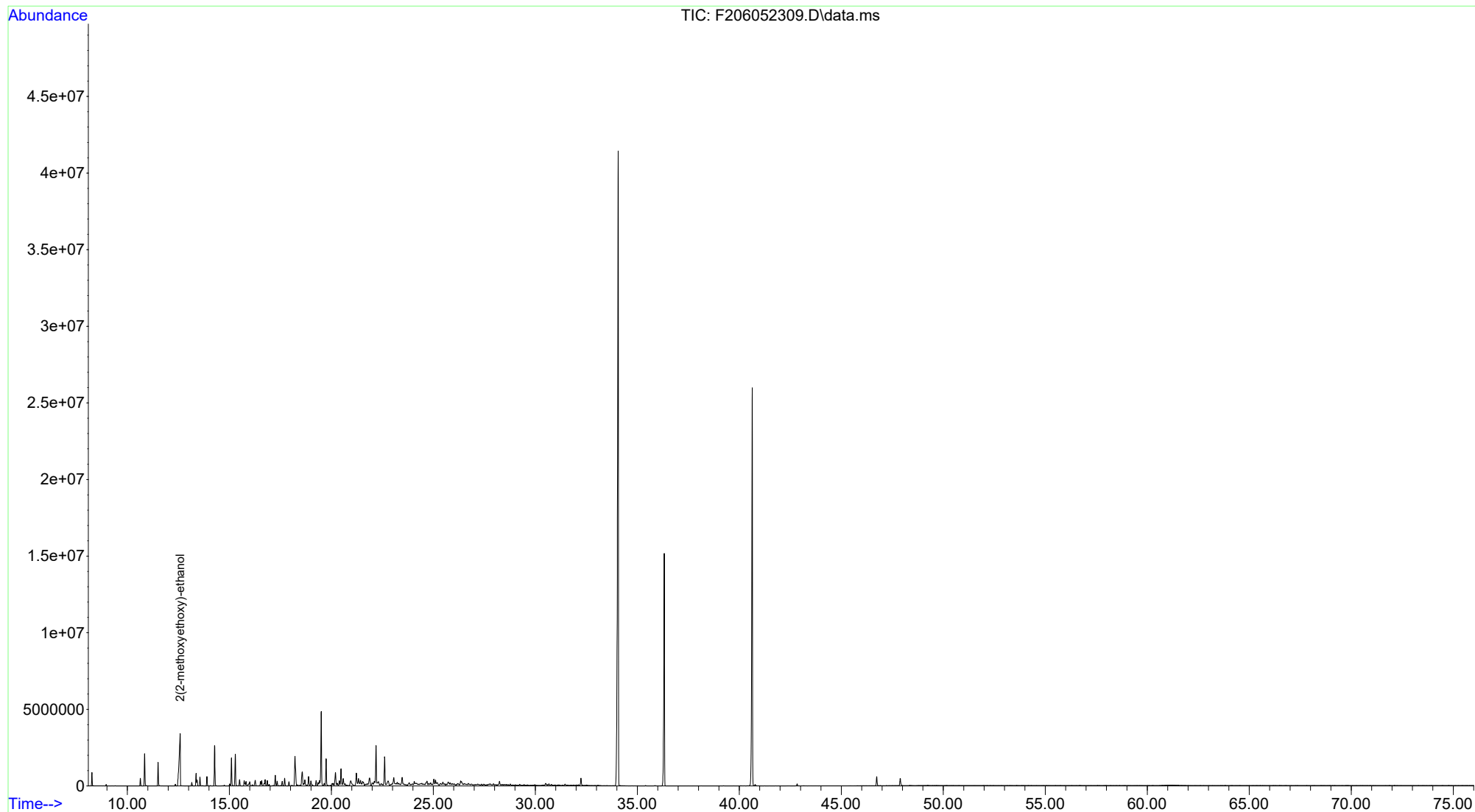

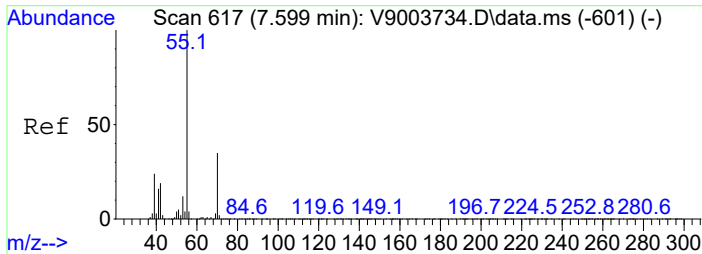

#1  
 2(2-methoxyethoxy)-ethanol  
 Concen: 20843.32 ug/L  
 RT: 12.585 min Scan# 760  
 Delta R.T. 0.000 min  
 Lab File: F206052309.D  
 Acq: 5 Jun 2023 6:59 pm

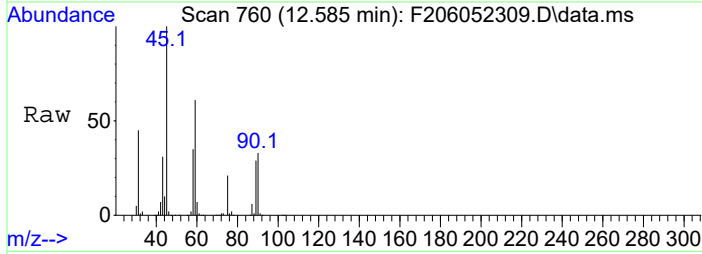

Tgt Ion: 45 Resp: 3540779

Ion	Ratio	Lower	Upper
45	100		
59	60.6	60.6	60.6#
75	20.9	20.9	20.9#

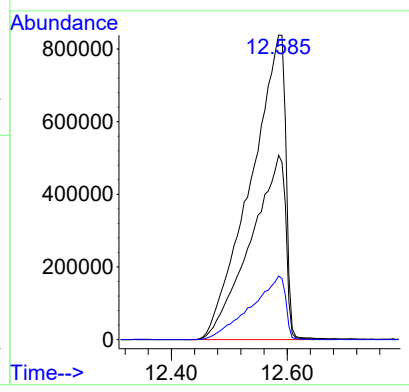
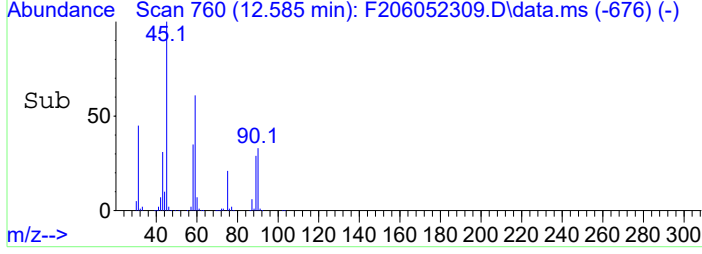

Data Path : C:\Projects\Hawaii DOH\2. Laboratory Data\Alpha\WAF Study\L2317027\FULLSCAN\  
 Data File : F205142323.D  
 Acq On : 15 May 2023 5:23 pm  
 Operator : PAH2:DP  
 Sample : 12317027-04  
 Misc :  
 ALS Vial : 22 Sample Multiplier: 1

Quant Time: Jun 02 12:15:59 2023  
 Quant Method : C:\Projects\Hawaii DOH\2. Laboratory Data\Alpha\WAF Study\L2317027\FULLSCAN\Additi  
 ves.M  
 Quant Title : PIANO VOLATILES  
 QLast Update : Fri Jun 02 12:15:24 2023  
 Response via : Initial Calibration

Compound	R.T.	QIon	Response	Conc	Units	Dev(Min)
-----						
Target Compounds						Qvalue
1) 2(2-methoxyethoxy)-eth...	12.899	45	2527066	19093.81	ug/L	# 100
2) 1-butoxy-2-propanol	13.024	45	1950359m	14736.37	ug/L	
-----						

(#) = qualifier out of range (m) = manual integration (+) = signals summed

Data Path : C:\Projects\Hawaii DOH\2. Laboratory Data\Alpha\WAF Study\L2317027\FULLSCAN\  
 Data File : F205142323.D  
 Acq On : 15 May 2023 5:23 pm  
 Operator : PAH2:DP  
 Sample : 12317027-04  
 Misc :  
 ALS Vial : 22 Sample Multiplier: 1

Quant Time: Jun 02 12:15:59 2023  
 Quant Method : C:\Projects\Hawaii DOH\2. Laboratory Data\Alpha\WAF Study\L2317027\FULLSCAN\Additi  
 ... ves.M  
 Quant Title : PIANO VOLATILES  
 QLast Update : Fri Jun 02 12:15:24 2023  
 Response via : Initial Calibration

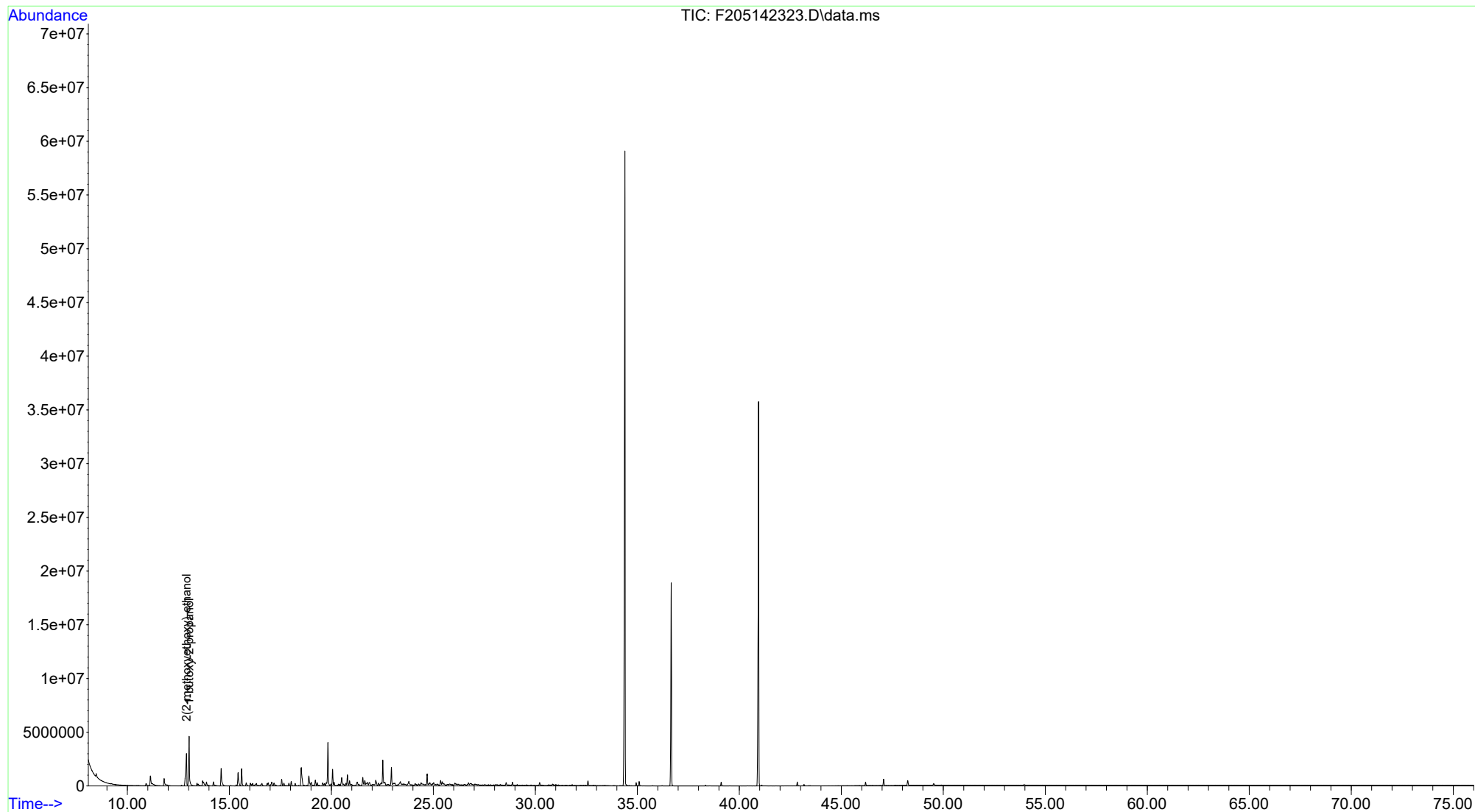

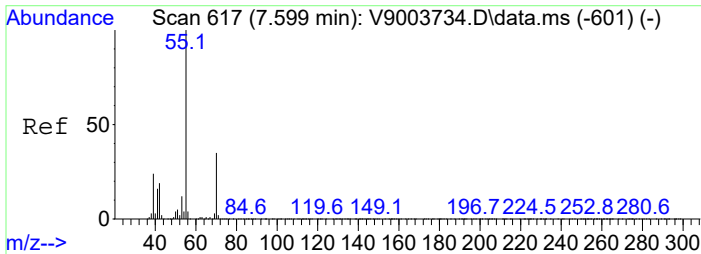

#1  
 2(2-methoxyethoxy)-ethanol  
 Concen: 19093.81 ug/L  
 RT: 12.899 min Scan# 813  
 Delta R.T. 0.000 min  
 Lab File: F205142323.D  
 Acq: 15 May 2023 5:23 pm

Tgt Ion	Resp	Lower	Upper
45	100		
59	58.3	58.3	58.3#
75	21.6	21.6	21.6#

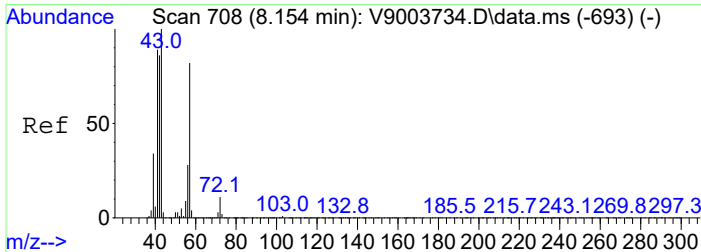
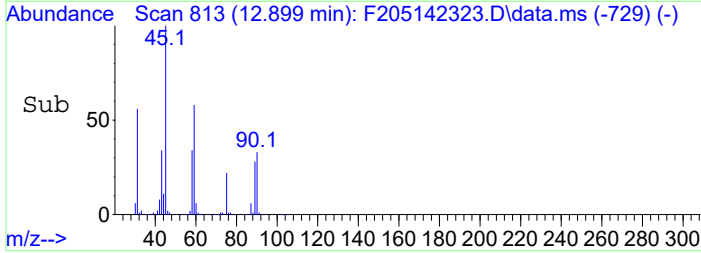
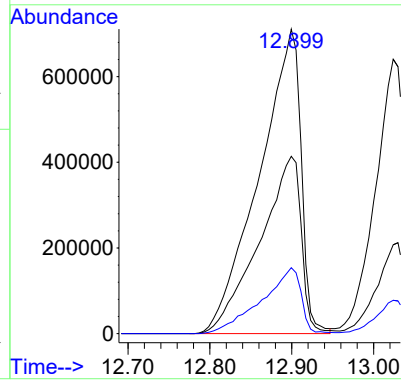
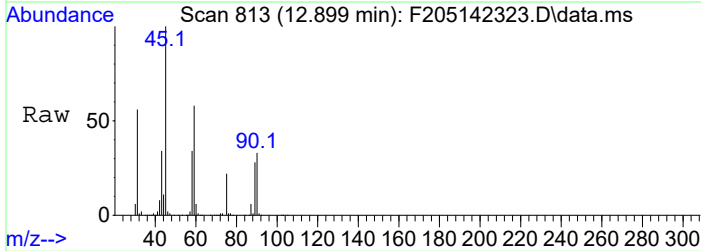

#2  
 1-butoxy-2-propanol  
 Concen: 14736.37 ug/L m  
 RT: 13.024 min Scan# 834  
 Delta R.T. -0.000 min  
 Lab File: F205142323.D  
 Acq: 15 May 2023 5:23 pm

Tgt Ion	Resp	Lower	Upper
45	100		
57	91.9	91.9	91.9#
87	108.4	108.4	108.4#

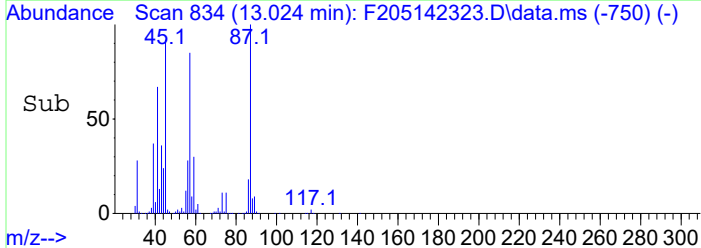
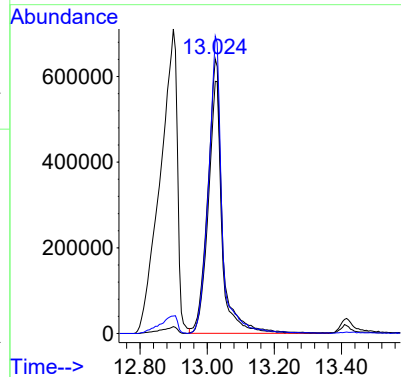
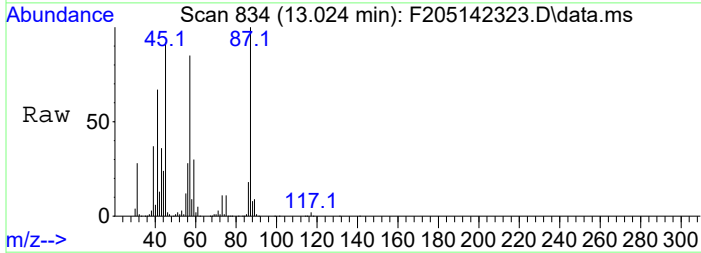



Data Path : C:\Projects\Hawaii DOH\2. Laboratory Data\Alpha\WAF Study\L2317027\FULLSCAN\  
 Data File : F206052310.D  
 Acq On : 5 Jun 2023 8:23 pm  
 Operator : PAH2:DP  
 Sample : L2317027-07  
 Misc :  
 ALS Vial : 9 Sample Multiplier: 1

Quant Time: Jun 07 13:21:46 2023  
 Quant Method : C:\Projects\Hawaii DOH\2. Laboratory Data\Alpha\WAF Study\L2317027\FULLSCAN\Additi  
 ves.20230607.M  
 Quant Title : PIANO VOLATILES  
 QLast Update : Wed Jun 07 13:20:10 2023  
 Response via : Initial Calibration

Compound	R.T.	QIon	Response	Conc	Units	Dev(Min)
-----						
Target Compounds						Qvalue
1) 2(2-methoxyethoxy)-eth...	12.591	45	3441396	20258.28	ug/L	# 99
-----						

(#) = qualifier out of range (m) = manual integration (+) = signals summed

Data Path : C:\Projects\Hawaii DOH\2. Laboratory Data\Alpha\WAF Study\L2317027\FULLSCAN\  
 Data File : F206052310.D  
 Acq On : 5 Jun 2023 8:23 pm  
 Operator : PAH2:DP  
 Sample : L2317027-07  
 Misc :  
 ALS Vial : 9 Sample Multiplier: 1

Quant Time: Jun 07 13:21:46 2023  
 Quant Method : C:\Projects\Hawaii DOH\2. Laboratory Data\Alpha\WAF Study\L2317027\FULLSCAN\Additi  
 ... ves.20230607.M  
 Quant Title : PIANO VOLATILES  
 QLast Update : Wed Jun 07 13:20:10 2023  
 Response via : Initial Calibration

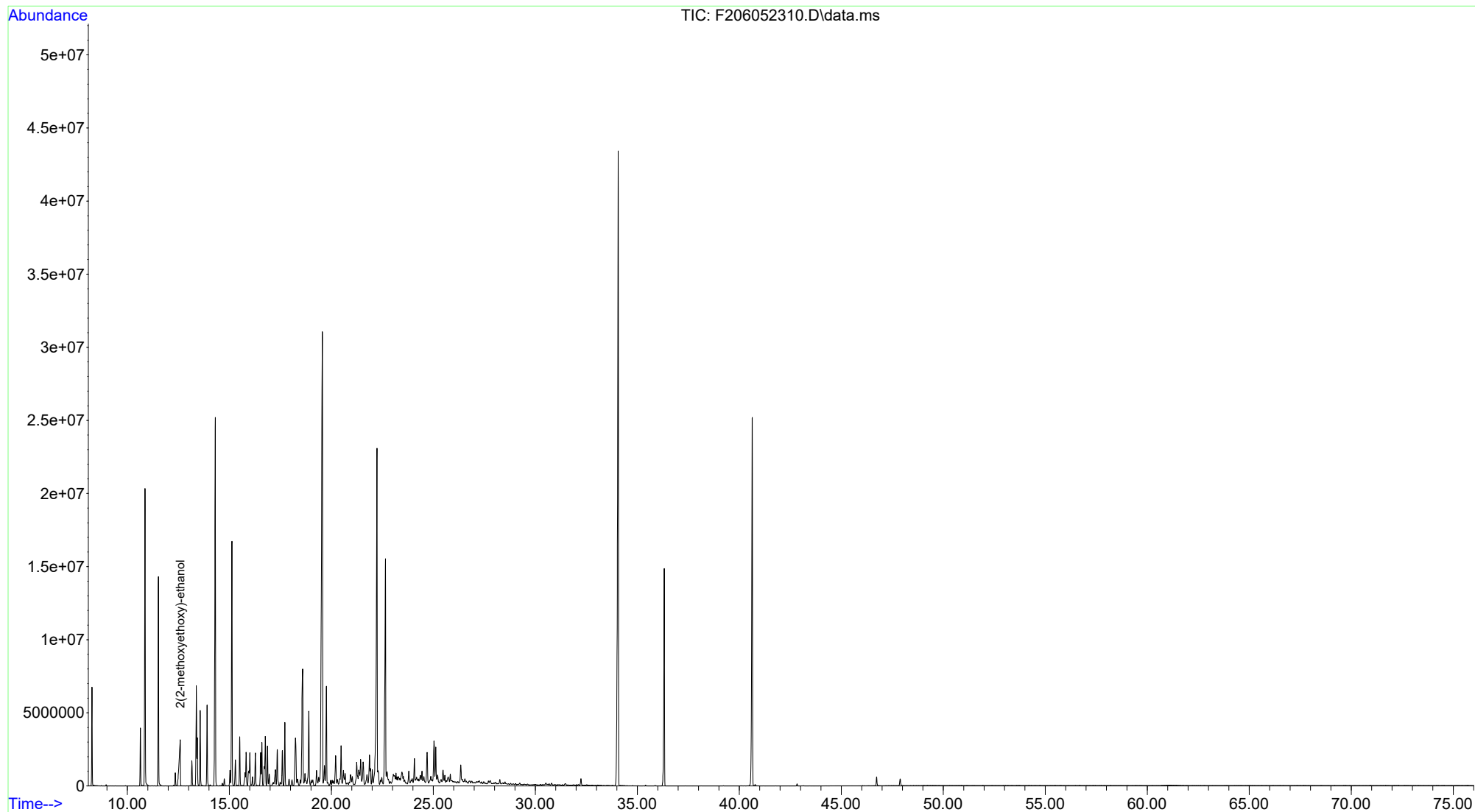

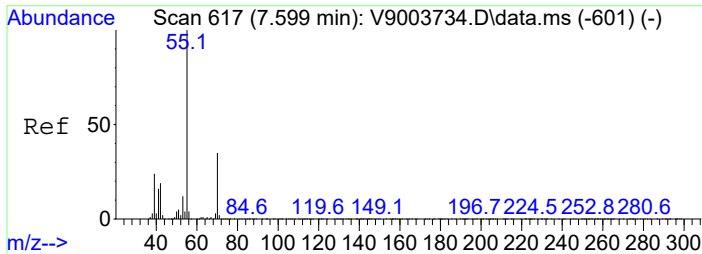

#1  
 2(2-methoxyethoxy)-ethanol  
 Concen: 20258.28 ug/L  
 RT: 12.591 min Scan# 761  
 Delta R.T. 0.006 min  
 Lab File: F206052310.D  
 Acq: 5 Jun 2023 8:23 pm

Tgt Ion	Resp	Lower	Upper
45	3441396		
45	100		
59	61.7	60.6	60.6#
75	20.7	20.9	20.9#

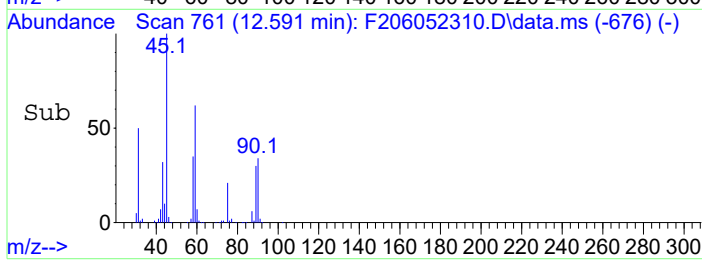
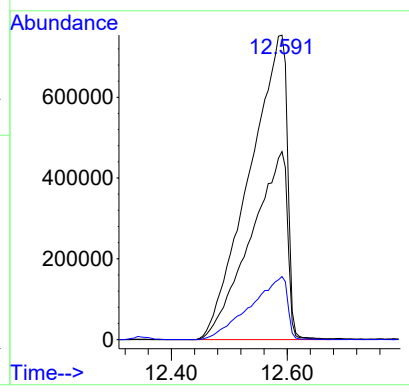
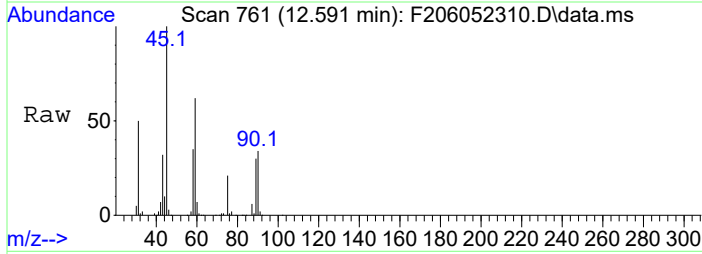

Data Path : C:\Projects\Hawaii DOH\2. Laboratory Data\Alpha\WAF Study\L2317027\FULLSCAN\  
 Data File : F205142324.D  
 Acq On : 15 May 2023 6:50 pm  
 Operator : PAH2:DP  
 Sample : 12317027-10  
 Misc :  
 ALS Vial : 23 Sample Multiplier: 1

Quant Time: Jun 02 12:16:45 2023  
 Quant Method : C:\Projects\Hawaii DOH\2. Laboratory Data\Alpha\WAF Study\L2317027\FULLSCAN\Additi  
 ves.M  
 Quant Title : PIANO VOLATILES  
 QLast Update : Fri Jun 02 12:15:24 2023  
 Response via : Initial Calibration

Compound	R.T.	QIon	Response	Conc	Units	Dev(Min)
-----						
Target Compounds						Qvalue
1) 2(2-methoxyethoxy)-eth...	12.905	45	2886798	21811.85	ug/L	# 99
2) 1-butoxy-2-propanol	13.030	45	2149979m	16244.65	ug/L	
-----						

(#) = qualifier out of range (m) = manual integration (+) = signals summed

Data Path : C:\Projects\Hawaii DOH\2. Laboratory Data\Alpha\WAF Study\L2317027\FULLSCAN\  
 Data File : F205142324.D  
 Acq On : 15 May 2023 6:50 pm  
 Operator : PAH2:DP  
 Sample : 12317027-10  
 Misc :  
 ALS Vial : 23 Sample Multiplier: 1

Quant Time: Jun 02 12:16:45 2023  
 Quant Method : C:\Projects\Hawaii DOH\2. Laboratory Data\Alpha\WAF Study\L2317027\FULLSCAN\Additi  
 ves.M  
 Quant Title : PIANO VOLATILES  
 QLast Update : Fri Jun 02 12:15:24 2023  
 Response via : Initial Calibration

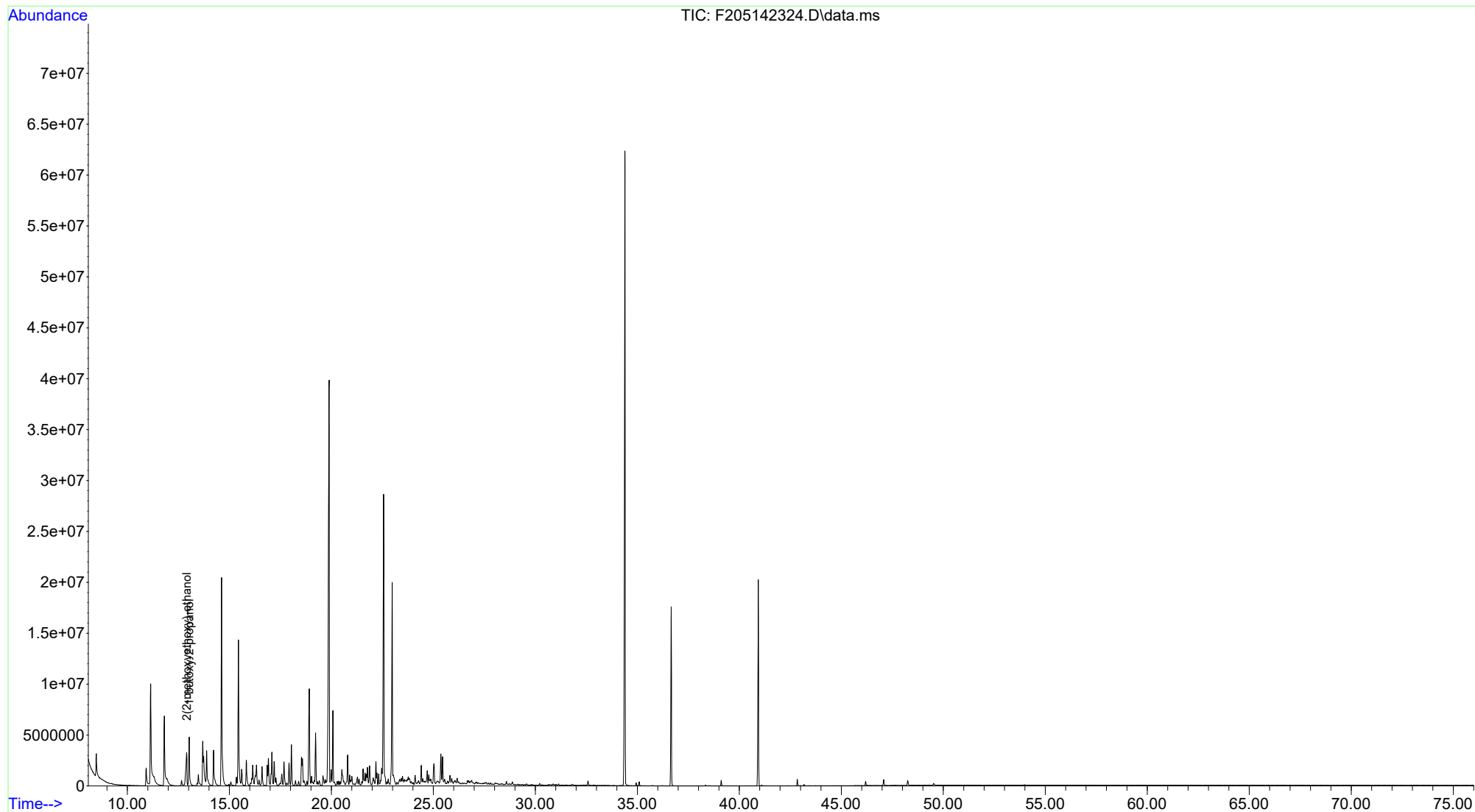

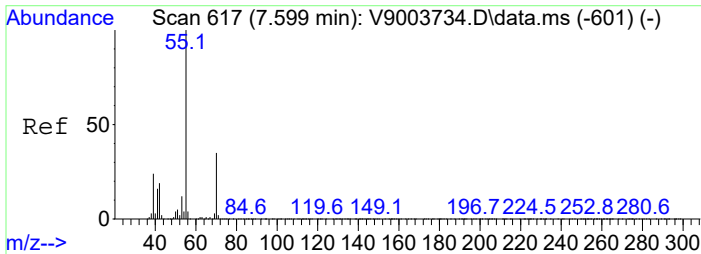

#1  
 2(2-methoxyethoxy)-ethanol  
 Concen: 21811.85 ug/L  
 RT: 12.905 min Scan# 814  
 Delta R.T. 0.006 min  
 Lab File: F205142324.D  
 Acq: 15 May 2023 6:50 pm

Tgt Ion: 45 Resp: 2886798

Ion	Ratio	Lower	Upper
45	100		
59	58.8	58.3	58.3#
75	21.1	21.6	21.6#

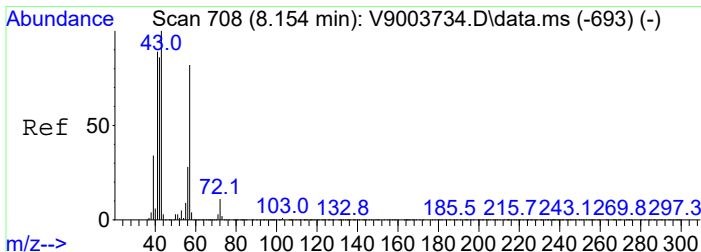
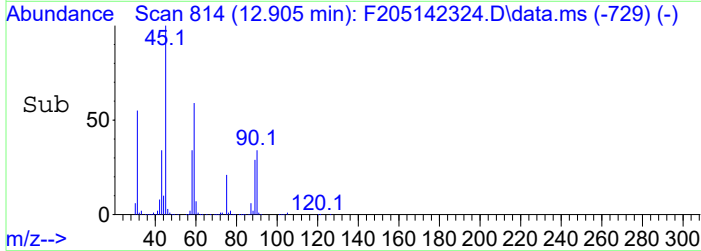
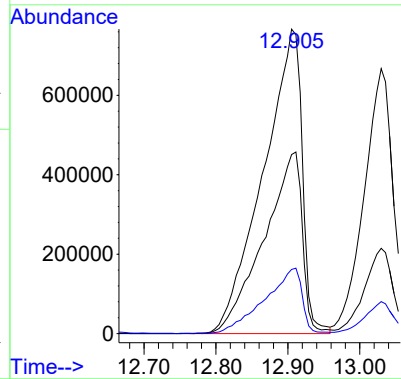
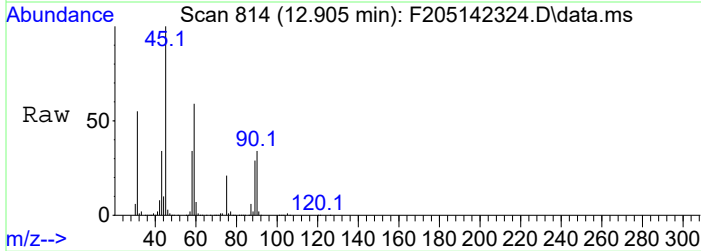

#2  
 1-butoxy-2-propanol  
 Concen: 16244.65 ug/L m  
 RT: 13.030 min Scan# 835  
 Delta R.T. 0.006 min  
 Lab File: F205142324.D  
 Acq: 15 May 2023 6:50 pm

Tgt Ion: 45 Resp: 2149979

Ion	Ratio	Lower	Upper
45	100		
57	93.9	91.9	91.9#
87	106.6	108.4	108.4#

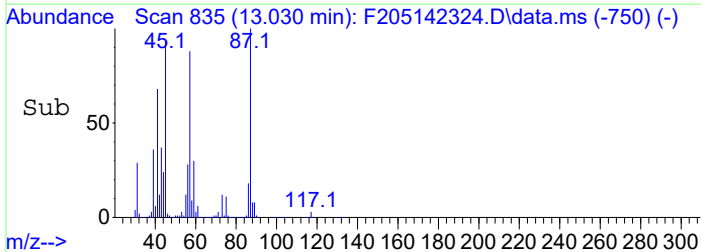
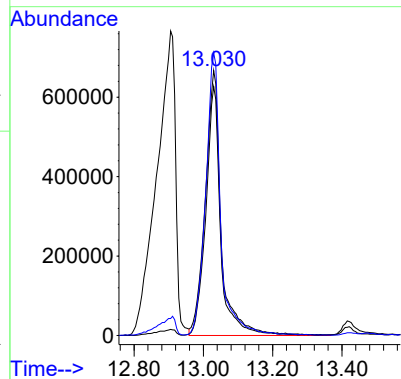
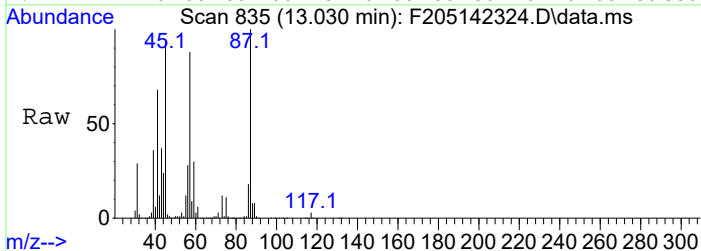

Data Path : C:\Projects\Hawaii DOH\2. Laboratory Data\Alpha\WAF Study\L2317027\FULLSCAN\  
 Data File : F206052311.D  
 Acq On : 5 Jun 2023 9:47 pm  
 Operator : PAH2:DP  
 Sample : L2317027-13  
 Misc :  
 ALS Vial : 10 Sample Multiplier: 1

Quant Time: Jun 07 13:22:04 2023  
 Quant Method : C:\Projects\Hawaii DOH\2. Laboratory Data\Alpha\WAF Study\L2317027\FULLSCAN\Additi  
 ves.20230607.M  
 Quant Title : PIANO VOLATILES  
 QLast Update : Wed Jun 07 13:20:10 2023  
 Response via : Initial Calibration

Compound	R.T.	QIon	Response	Conc	Units	Dev(Min)
-----						
Target Compounds						Qvalue
1) 2(2-methoxyethoxy)-eth...	12.597	45	3681349	21670.80	ug/L	# 97
-----						

(#) = qualifier out of range (m) = manual integration (+) = signals summed

Data Path : C:\Projects\Hawaii DOH\2. Laboratory Data\Alpha\WAF Study\L2317027\FULLSCAN\  
 Data File : F206052311.D  
 Acq On : 5 Jun 2023 9:47 pm  
 Operator : PAH2:DP  
 Sample : L2317027-13  
 Misc :  
 ALS Vial : 10 Sample Multiplier: 1

Quant Time: Jun 07 13:22:04 2023  
 Quant Method : C:\Projects\Hawaii DOH\2. Laboratory Data\Alpha\WAF Study\L2317027\FULLSCAN\Additi  
 ... ves.20230607.M  
 Quant Title : PIANO VOLATILES  
 QLast Update : Wed Jun 07 13:20:10 2023  
 Response via : Initial Calibration

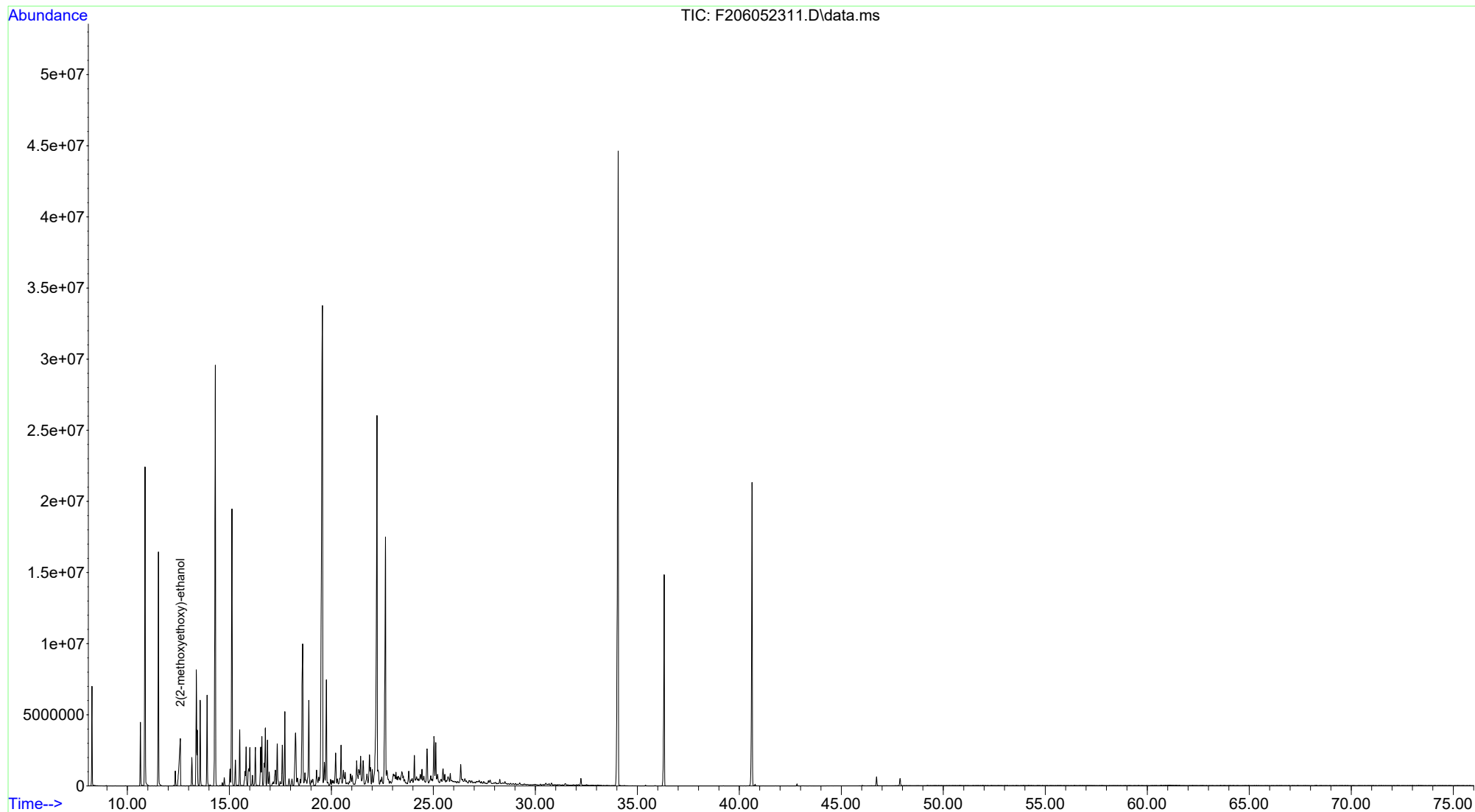



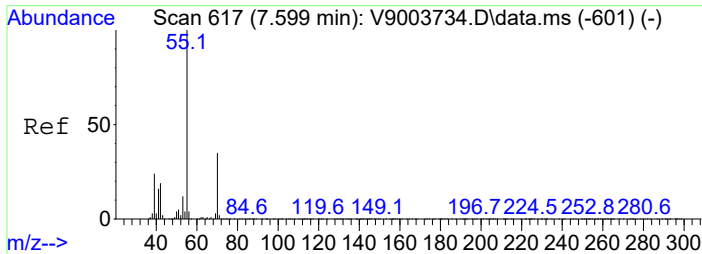

#1  
 2(2-methoxyethoxy)-ethanol  
 Concen: 21670.80 ug/L  
 RT: 12.597 min Scan# 762  
 Delta R.T. 0.012 min  
 Lab File: F206052311.D  
 Acq: 5 Jun 2023 9:47 pm

Tgt Ion	Resp	Lower	Upper
45	3681349		
45	100		
59	63.1	60.6	60.6#
75	21.6	20.9	20.9#

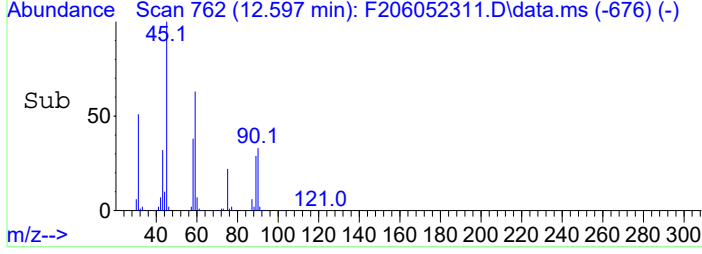
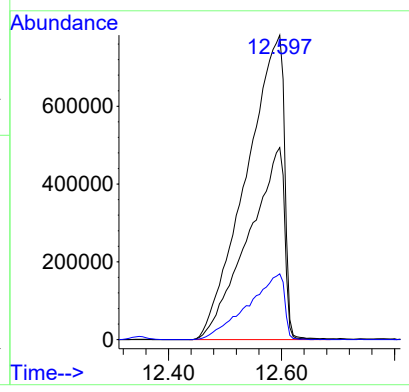
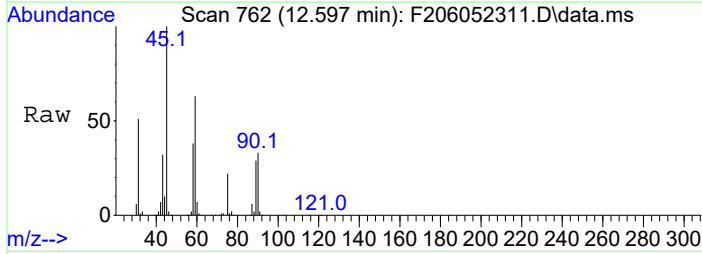

Data Path : C:\Projects\Hawaii DOH\2. Laboratory Data\Alpha\WAF Study\L2317027\FULLSCAN\  
 Data File : F205142325.D  
 Acq On : 15 May 2023 8:17 pm  
 Operator : PAH2:DP  
 Sample : 12317027-16  
 Misc :  
 ALS Vial : 24 Sample Multiplier: 1

Quant Time: Jun 02 12:17:14 2023  
 Quant Method : C:\Projects\Hawaii DOH\2. Laboratory Data\Alpha\WAF Study\L2317027\FULLSCAN\Additi  
 ves.M  
 Quant Title : PIANO VOLATILES  
 QLast Update : Fri Jun 02 12:15:24 2023  
 Response via : Initial Calibration

Compound	R.T.	QIon	Response	Conc	Units	Dev(Min)
-----						
Target Compounds						Qvalue
1) 2(2-methoxyethoxy)-eth...	12.911	45	3298644	24923.64	ug/L	# 98
2) 1-butoxy-2-propanol	13.030	45	2006825m	15163.01	ug/L	
-----						

(#) = qualifier out of range (m) = manual integration (+) = signals summed

Data Path : C:\Projects\Hawaii DOH\2. Laboratory Data\Alpha\WAF Study\L2317027\FULLSCAN\  
 Data File : F205142325.D  
 Acq On : 15 May 2023 8:17 pm  
 Operator : PAH2:DP  
 Sample : 12317027-16  
 Misc :  
 ALS Vial : 24 Sample Multiplier: 1

Quant Time: Jun 02 12:17:14 2023  
 Quant Method : C:\Projects\Hawaii DOH\2. Laboratory Data\Alpha\WAF Study\L2317027\FULLSCAN\Additi  
 ves.M  
 Quant Title : PIANO VOLATILES  
 QLast Update : Fri Jun 02 12:15:24 2023  
 Response via : Initial Calibration

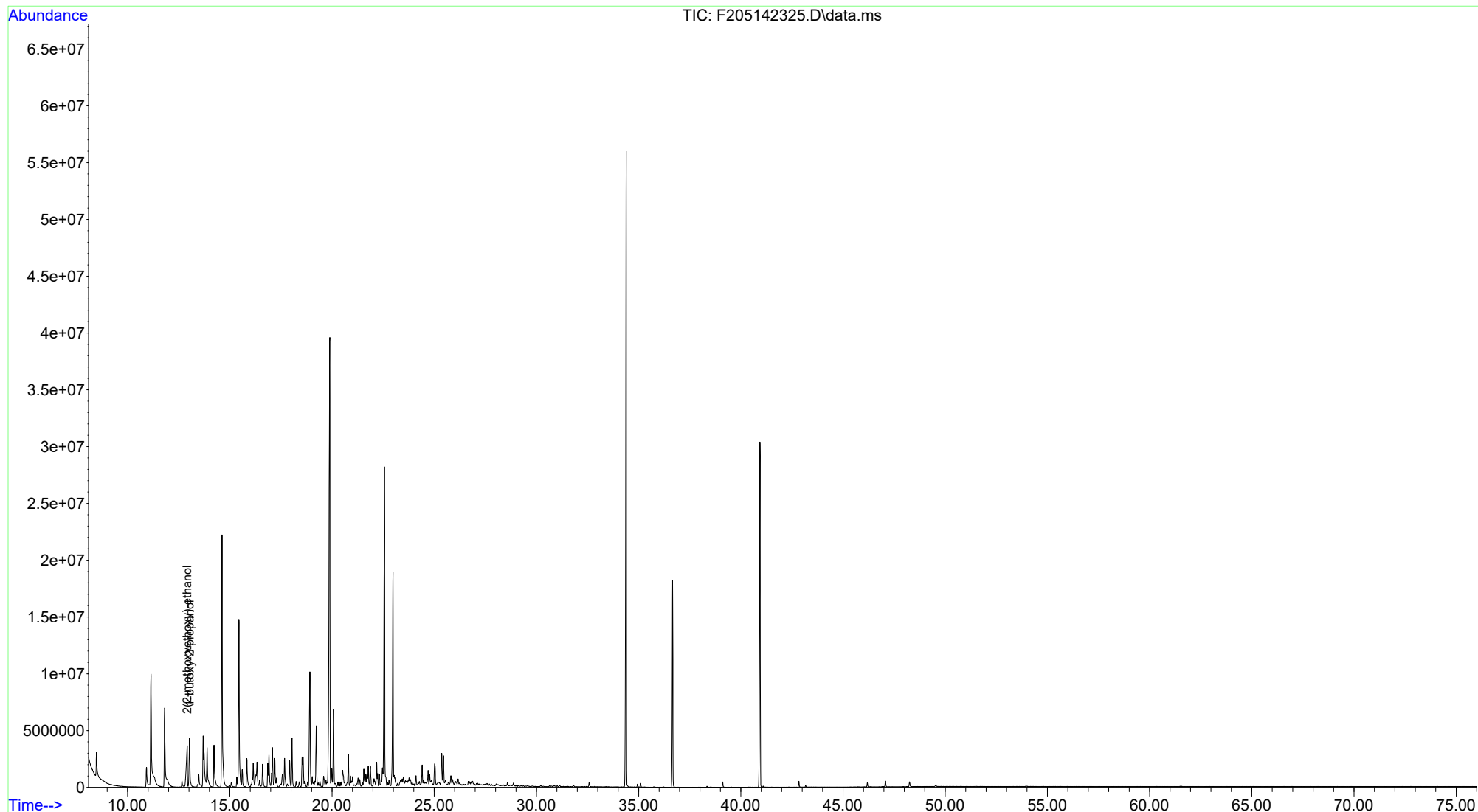

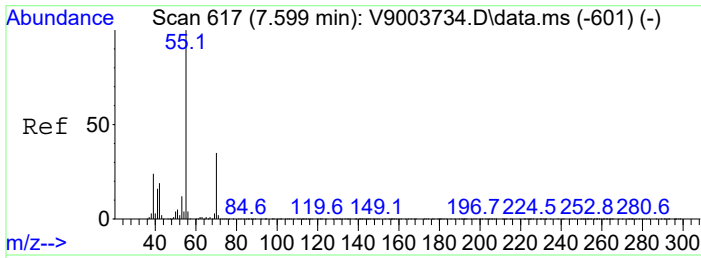

#1  
 2(2-methoxyethoxy)-ethanol  
 Concen: 24923.64 ug/L  
 RT: 12.911 min Scan# 815  
 Delta R.T. 0.012 min  
 Lab File: F205142325.D  
 Acq: 15 May 2023 8:17 pm

Tgt Ion	Resp	Lower	Upper
45	100		
59	57.6	58.3	58.3#
75	20.2	21.6	21.6#

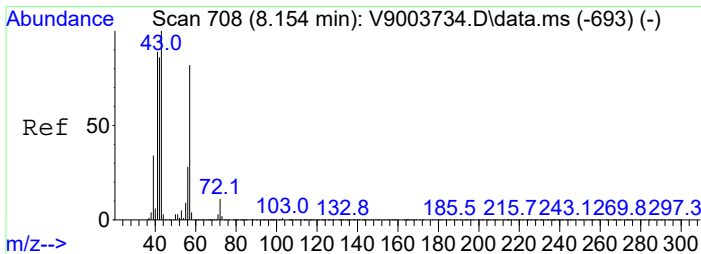
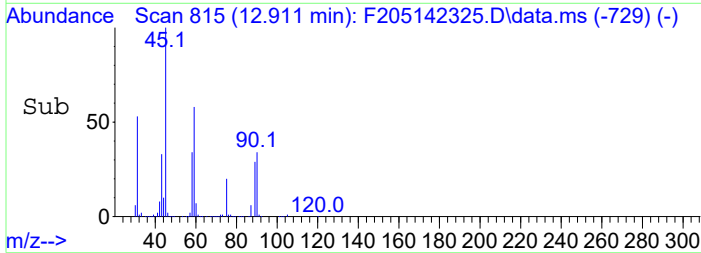
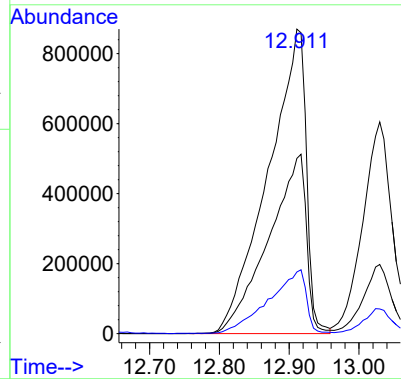
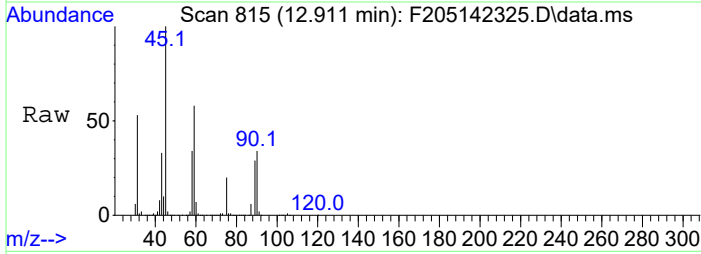

#2  
 1-butoxy-2-propanol  
 Concen: 15163.01 ug/L m  
 RT: 13.030 min Scan# 835  
 Delta R.T. 0.006 min  
 Lab File: F205142325.D  
 Acq: 15 May 2023 8:17 pm

Tgt Ion	Resp	Lower	Upper
45	100		
57	91.6	91.9	91.9#
87	105.3	108.4	108.4#

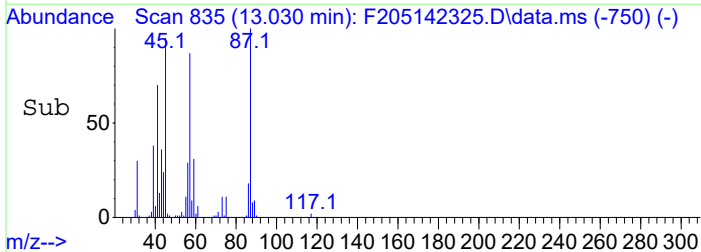
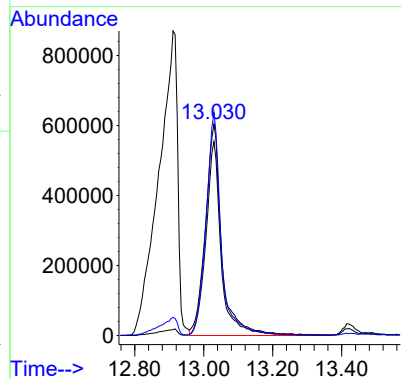
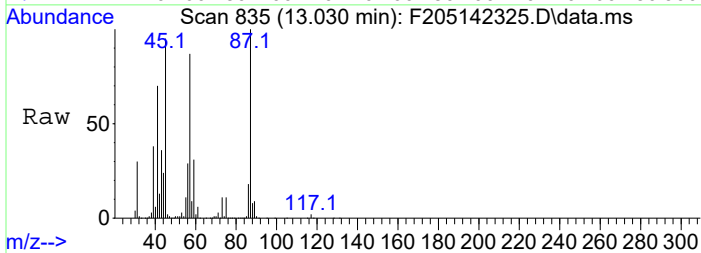

Data Path : C:\Projects\Hawaii DOH\2. Laboratory Data\Alpha\WAF Study\L2317027\FULLSCAN\  
 Data File : F206052312.D  
 Acq On : 5 Jun 2023 11:11 pm  
 Operator : PAH2:DP  
 Sample : L2317027-19  
 Misc :  
 ALS Vial : 11 Sample Multiplier: 1

Quant Time: Jun 07 13:22:21 2023  
 Quant Method : C:\Projects\Hawaii DOH\2. Laboratory Data\Alpha\WAF Study\L2317027\FULLSCAN\Additi  
 ves.20230607.M  
 Quant Title : PIANO VOLATILES  
 QLast Update : Wed Jun 07 13:20:10 2023  
 Response via : Initial Calibration

Compound	R.T.	QIon	Response	Conc	Units	Dev(Min)
-----						
Target Compounds						Qvalue
1) 2(2-methoxyethoxy)-eth...	12.591	45	3715413	21871.32	ug/L	# 99
-----						

(#) = qualifier out of range (m) = manual integration (+) = signals summed

Data Path : C:\Projects\Hawaii DOH\2. Laboratory Data\Alpha\WAF Study\L2317027\FULLSCAN\  
 Data File : F206052312.D  
 Acq On : 5 Jun 2023 11:11 pm  
 Operator : PAH2:DP  
 Sample : L2317027-19  
 Misc :  
 ALS Vial : 11 Sample Multiplier: 1

Quant Time: Jun 07 13:22:21 2023  
 Quant Method : C:\Projects\Hawaii DOH\2. Laboratory Data\Alpha\WAF Study\L2317027\FULLSCAN\Additi  
 ... ves.20230607.M  
 Quant Title : PIANO VOLATILES  
 QLast Update : Wed Jun 07 13:20:10 2023  
 Response via : Initial Calibration

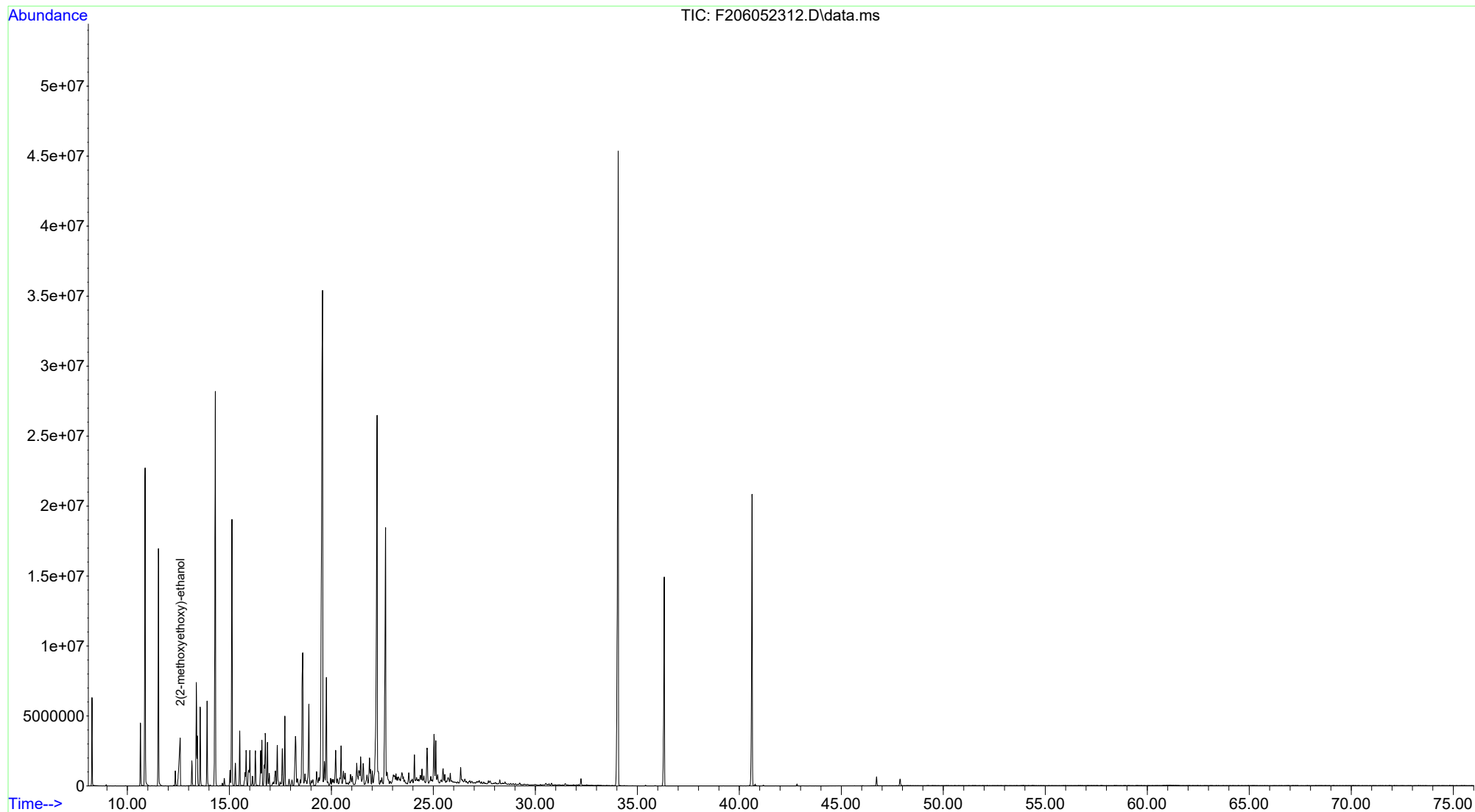

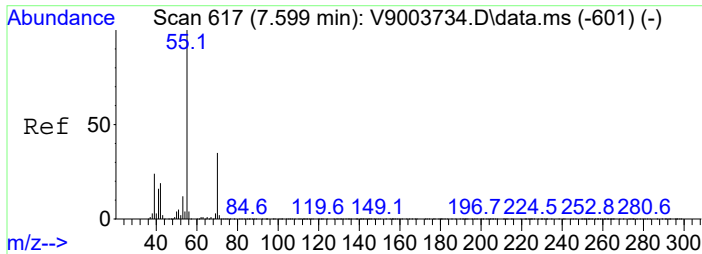

#1  
 2(2-methoxyethoxy)-ethanol  
 Concen: 21871.32 ug/L  
 RT: 12.591 min Scan# 761  
 Delta R.T. 0.006 min  
 Lab File: F206052312.D  
 Acq: 5 Jun 2023 11:11 pm

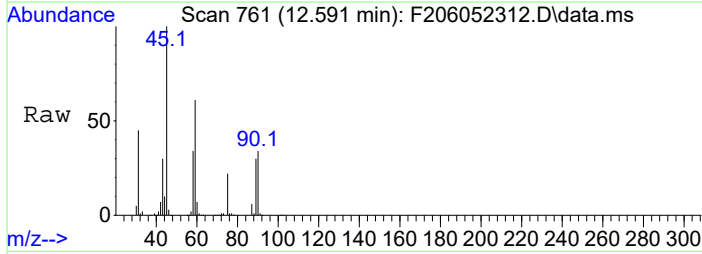

Tgt Ion: 45 Resp: 3715413

Ion	Ratio	Lower	Upper
45	100		
59	61.4	60.6	60.6#
75	21.8	20.9	20.9#

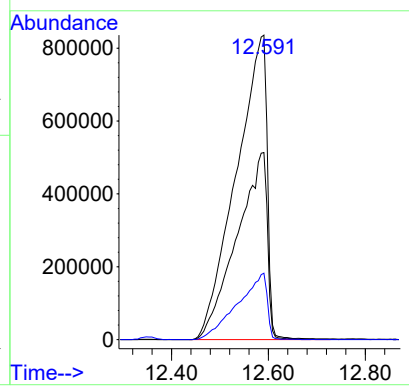
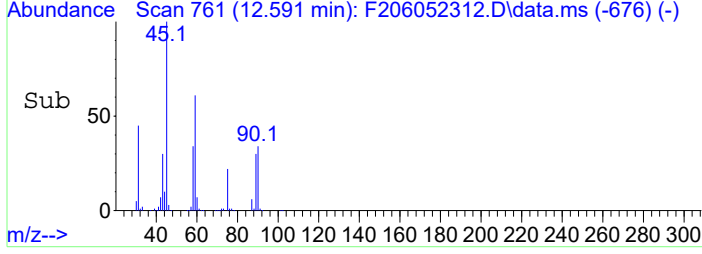

Data Path : C:\Projects\Hawaii DOH\2. Laboratory Data\Alpha\WAF Study\L2317027\FULLSCAN\  
 Data File : F205142326.D  
 Acq On : 15 May 2023 9:45 pm  
 Operator : PAH2:DP  
 Sample : 12317027-22  
 Misc :  
 ALS Vial : 25 Sample Multiplier: 1

Quant Time: Jun 02 12:17:45 2023  
 Quant Method : C:\Projects\Hawaii DOH\2. Laboratory Data\Alpha\WAF Study\L2317027\FULLSCAN\Additi  
 ves.M  
 Quant Title : PIANO VOLATILES  
 QLast Update : Fri Jun 02 12:15:24 2023  
 Response via : Initial Calibration

Compound	R.T.	QIon	Response	Conc	Units	Dev(Min)	
-----							
Target Compounds							Qvalue
1) 2(2-methoxyethoxy)-eth...	12.899	45	2589563	19566.02	ug/L	#	98
2) 1-butoxy-2-propanol	13.030	45	2127974m	16078.38	ug/L		
-----							

(#) = qualifier out of range (m) = manual integration (+) = signals summed



Data Path : C:\Projects\Hawaii DOH\2. Laboratory Data\Alpha\WAF Study\L2317027\FULLSCAN\  
Data File : F205142326.D  
Acq On : 15 May 2023 9:45 pm  
Operator : PAH2:DP  
Sample : 12317027-22  
Misc :  
ALS Vial : 25 Sample Multiplier: 1

Quant Time: Jun 02 12:17:45 2023  
Quant Method : C:\Projects\Hawaii DOH\2. Laboratory Data\Alpha\WAF Study\L2317027\FULLSCAN\Additi  
... ves.M  
Quant Title : PIANO VOLATILES  
QLast Update : Fri Jun 02 12:15:24 2023  
Response via : Initial Calibration

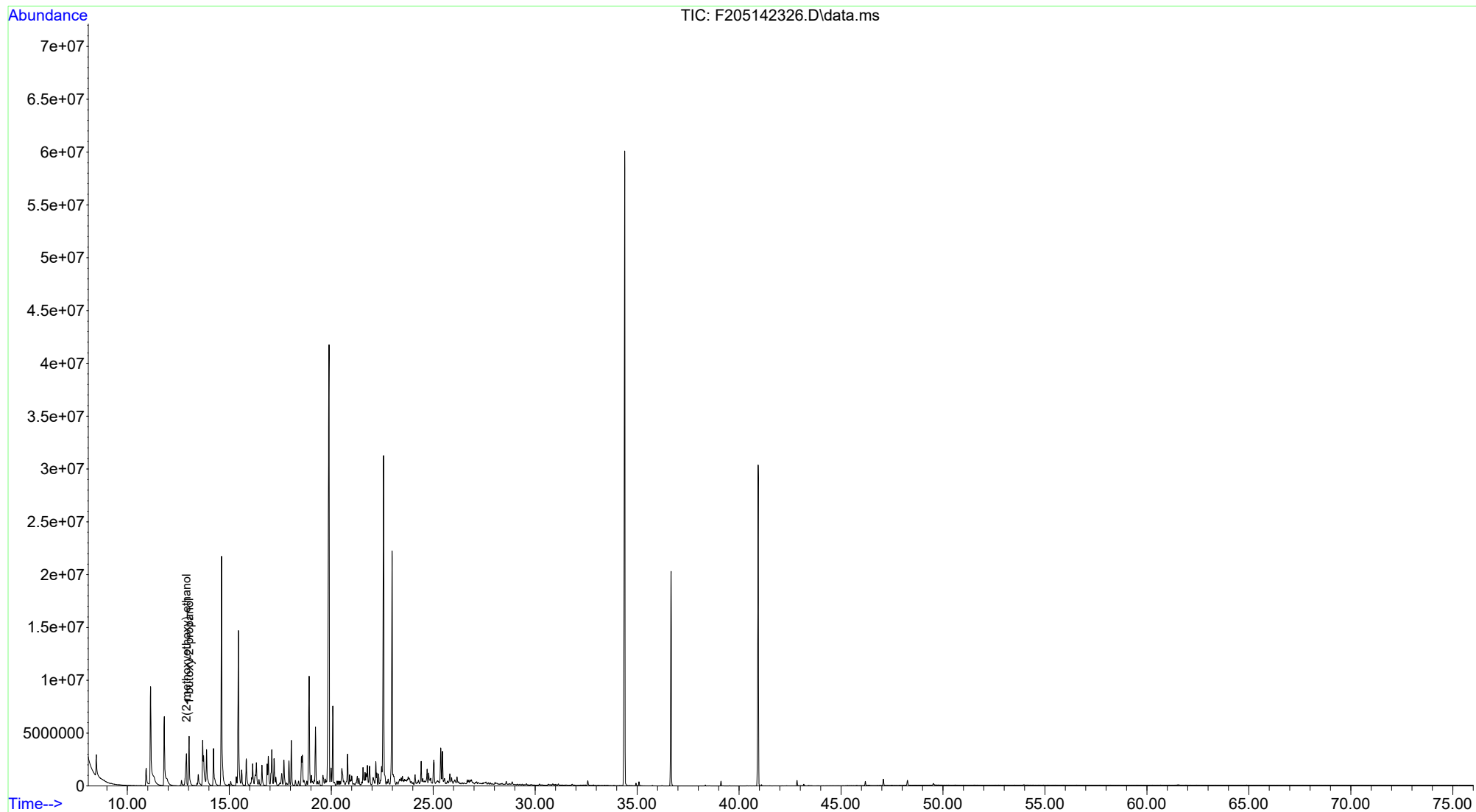

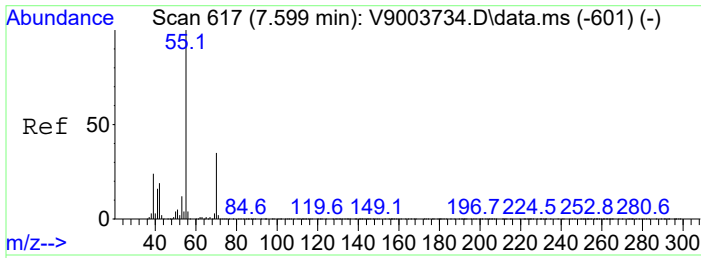

#1  
 2(2-methoxyethoxy)-ethanol  
 Concen: 19566.02 ug/L  
 RT: 12.899 min Scan# 813  
 Delta R.T. 0.000 min  
 Lab File: F205142326.D  
 Acq: 15 May 2023 9:45 pm

Tgt Ion	Resp	Lower	Upper
45	100		
59	59.6	58.3	58.3#
75	20.7	21.6	21.6#

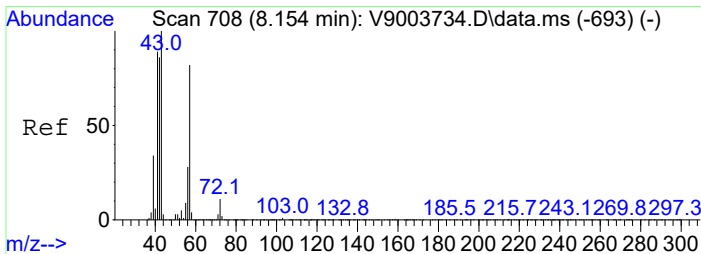
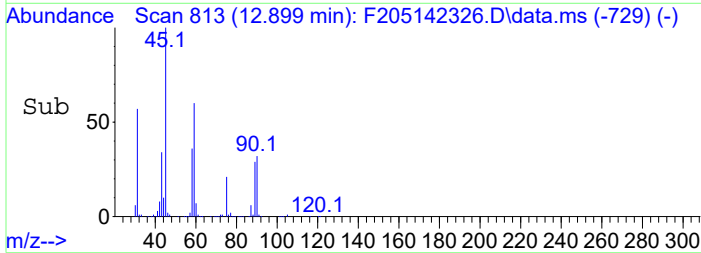
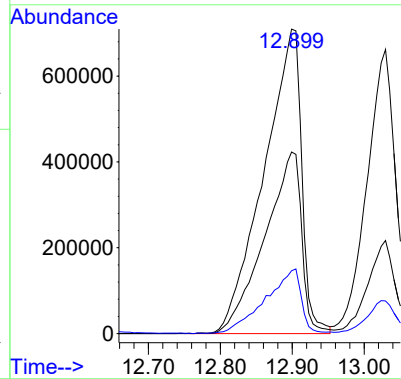
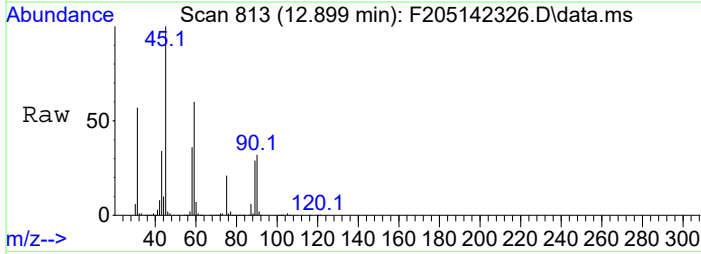

#2  
 1-butoxy-2-propanol  
 Concen: 16078.38 ug/L m  
 RT: 13.030 min Scan# 835  
 Delta R.T. 0.006 min  
 Lab File: F205142326.D  
 Acq: 15 May 2023 9:45 pm

Tgt Ion	Resp	Lower	Upper
45	100		
57	92.1	91.9	91.9#
87	104.1	108.4	108.4#

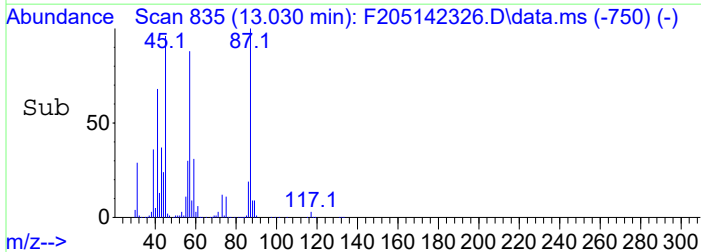
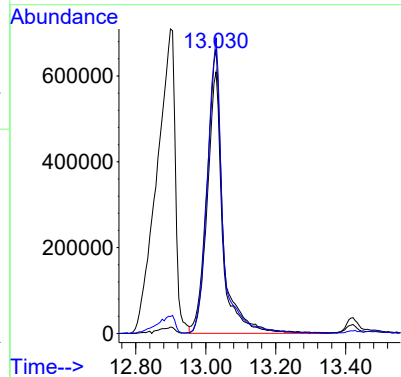
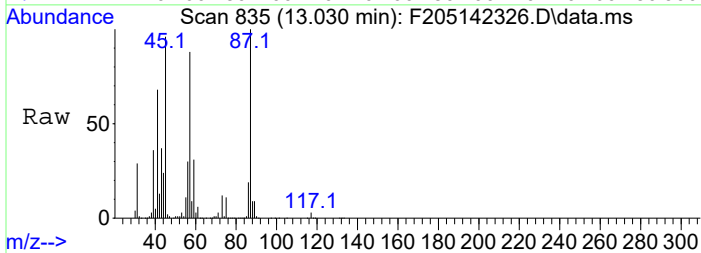

Data Path : C:\Projects\Hawaii DOH\2. Laboratory Data\Alpha\WAF Study\L2317027\FULLSCAN\  
 Data File : F205142327.D  
 Acq On : 15 May 2023 11:12 pm  
 Operator : PAH2:DP  
 Sample : 12317027-28  
 Misc :  
 ALS Vial : 26 Sample Multiplier: 1

Quant Time: Jun 02 12:18:19 2023  
 Quant Method : C:\Projects\Hawaii DOH\2. Laboratory Data\Alpha\WAF Study\L2317027\FULLSCAN\Additi  
 ves.M  
 Quant Title : PIANO VOLATILES  
 QLast Update : Fri Jun 02 12:15:24 2023  
 Response via : Initial Calibration

Compound	R.T.	QIon	Response	Conc	Units	Dev(Min)
-----						
Target Compounds						Qvalue
1) 2(2-methoxyethoxy)-eth...	12.911	45	2924548	22097.08	ug/L	# 99
2) 1-butoxy-2-propanol	13.030	45	2290561m	17306.85	ug/L	
-----						

(#) = qualifier out of range (m) = manual integration (+) = signals summed

Data Path : C:\Projects\Hawaii DOH\2. Laboratory Data\Alpha\WAF Study\L2317027\FULLSCAN\  
 Data File : F205142327.D  
 Acq On : 15 May 2023 11:12 pm  
 Operator : PAH2:DP  
 Sample : 12317027-28  
 Misc :  
 ALS Vial : 26 Sample Multiplier: 1

Quant Time: Jun 02 12:18:19 2023  
 Quant Method : C:\Projects\Hawaii DOH\2. Laboratory Data\Alpha\WAF Study\L2317027\FULLSCAN\Additi  
 ves.M  
 Quant Title : PIANO VOLATILES  
 QLast Update : Fri Jun 02 12:15:24 2023  
 Response via : Initial Calibration

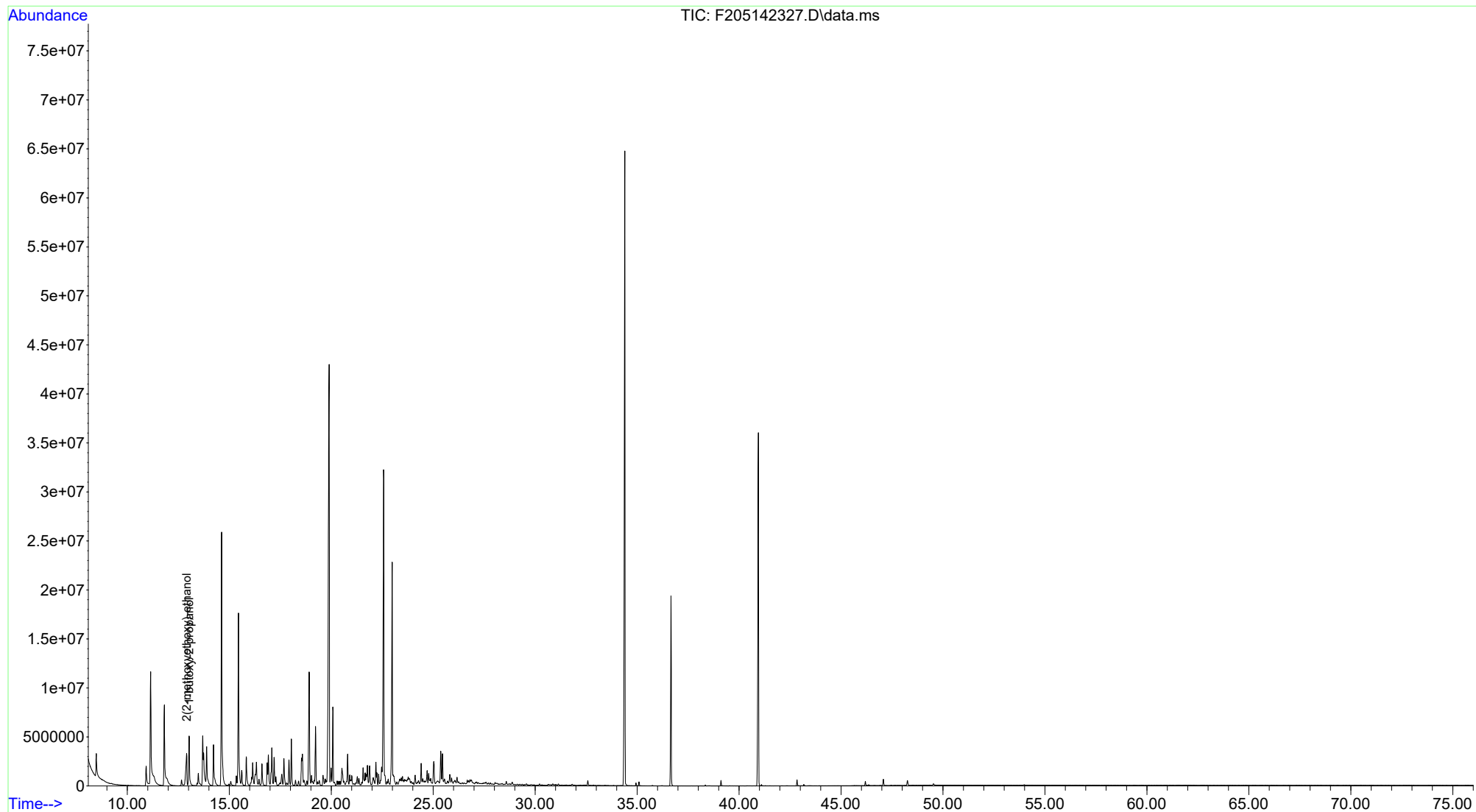

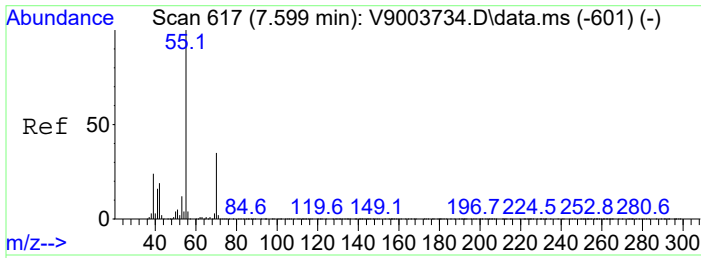

#1  
 2(2-methoxyethoxy)-ethanol  
 Concen: 22097.08 ug/L  
 RT: 12.911 min Scan# 815  
 Delta R.T. 0.012 min  
 Lab File: F205142327.D  
 Acq: 15 May 2023 11:12 pm

Tgt Ion: 45 Resp: 2924548

Ion	Ratio	Lower	Upper
45	100		
59	58.7	58.3	58.3#
75	20.9	21.6	21.6#

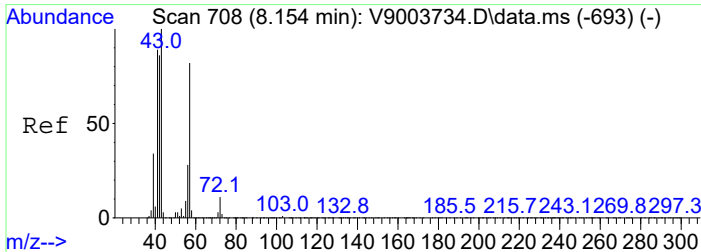
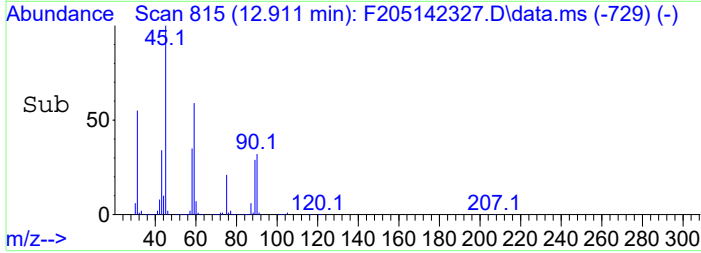
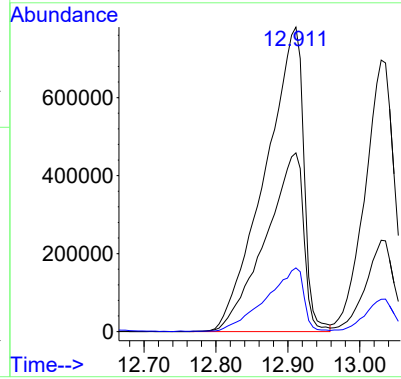
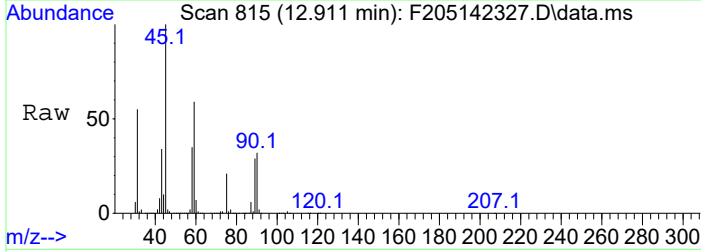

#2  
 1-butoxy-2-propanol  
 Concen: 17306.85 ug/L m  
 RT: 13.030 min Scan# 835  
 Delta R.T. 0.006 min  
 Lab File: F205142327.D  
 Acq: 15 May 2023 11:12 pm

Tgt Ion: 45 Resp: 2290561

Ion	Ratio	Lower	Upper
45	100		
57	95.7	91.9	91.9#
87	106.8	108.4	108.4#

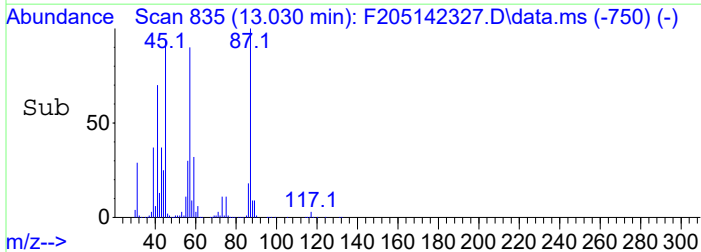
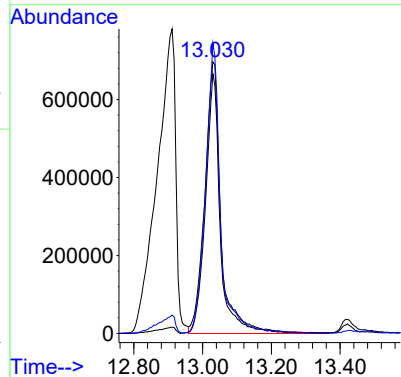
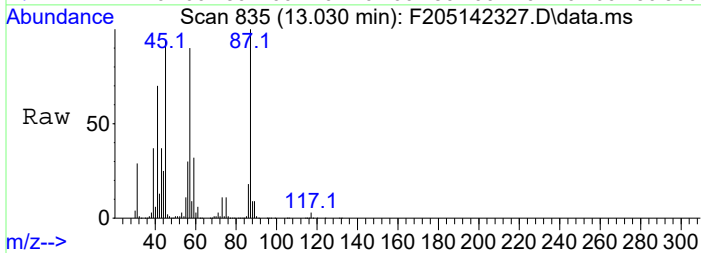

## **Example JP-5 Experiment Chromatograms (Newfields 2023)**

# JP-5 Product (Neat).FID Chromatogram

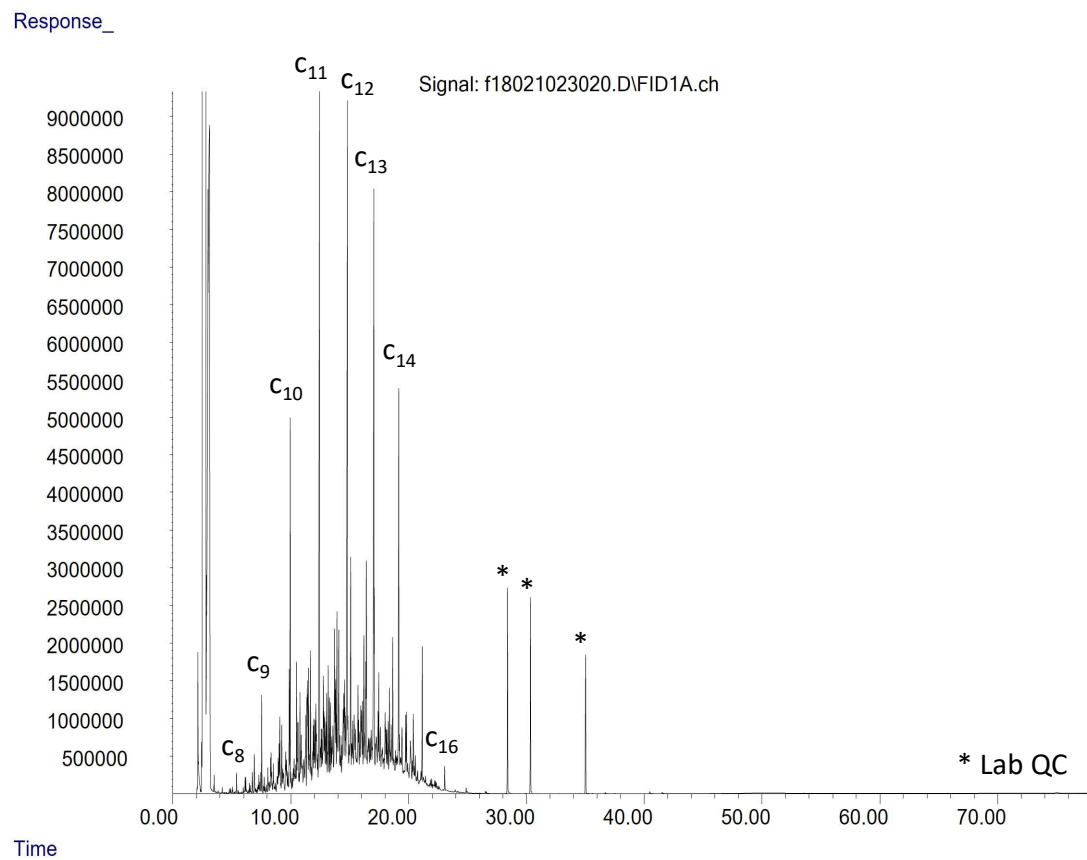

# JP-5 Product (Vapor).FID Chromatogram

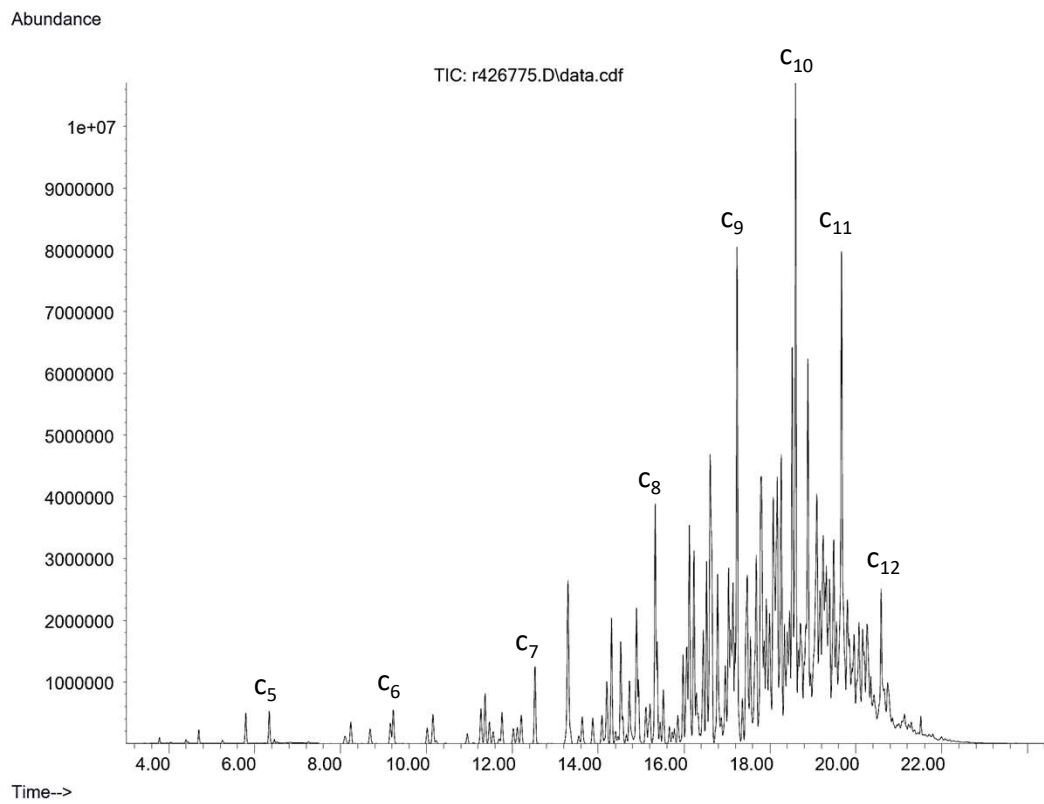



# WAF Day 20 (F2 Dissolved Aromatics).FID Chromatogram

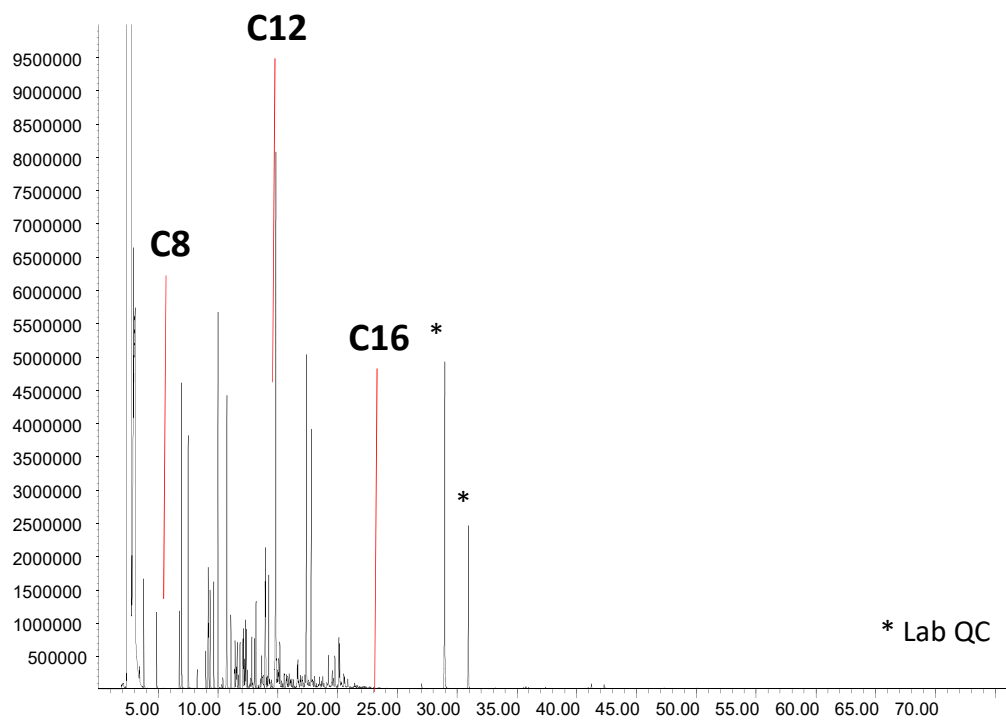

**Chemistry and Toxicity of Petroleum Vapors (Brewer et al (2013))**  
**Common TPH questions (HDOH 2012)**

Article

## Risk-Based Evaluation of Total Petroleum Hydrocarbons in Vapor Intrusion Studies

Roger Brewer <sup>1,\*</sup>, Josh Nagashima <sup>1,†</sup>, Michael Kelley <sup>2,†</sup>, Marvin Heskett <sup>3,†</sup> and Mark Rigby <sup>4,†</sup>

<sup>1</sup> Hawaii Department of Health, 919 Ala Moana Blvd Room 206, Honolulu, HI 96814, USA;  
E-Mail: josh.nagashima@doh.hawaii.gov

<sup>2</sup> EA Engineering, Science and Technology, 615 Piikoi St #515, Honolulu, HI 96814, USA;  
E-Mail: mkelley@eaest.com

<sup>3</sup> Geotek Hawaii, Inc., P.O. Box 1555, Pearl City, HI 96782, USA; E-Mail: mhesketts@mac.com

<sup>4</sup> Parsons Corporation, 10235 South Jordan Gateway, Suite 300, South Jordan, UT 8409, USA;  
E-Mail: mark.rigby@parsons.com

† These authors contributed equally to this work.

\* Author to whom correspondence should be addressed; E-Mail: roger.brewer@doh.hawaii.gov;  
Tel.: +1-808-586-4249; Fax: +1-808-586-7537.

*Received: 9 April 2013; in revised form: 8 May 2013 / Accepted: 24 May 2013 /*

*Published: 13 June 2013*

---

**Abstract:** This paper presents a quantitative method for the risk-based evaluation of Total Petroleum Hydrocarbons (TPH) in vapor intrusion investigations. Vapors from petroleum fuels are characterized by a complex mixture of aliphatic and, to a lesser extent, aromatic compounds. These compounds can be measured and described in terms of TPH carbon ranges. Toxicity factors published by USEPA and other parties allow development of risk-based, air and soil vapor screening levels for each carbon range in the same manner as done for individual compounds such as benzene. The relative, carbon range makeup of petroleum vapors can be used to develop weighted, site-specific or generic screening levels for TPH. At some critical ratio of TPH to a targeted, individual compound, the overwhelming proportion of TPH will drive vapor intrusion risk over the individual compound. This is particularly true for vapors associated with diesel and other middle distillate fuels, but can also be the case for low-benzene gasolines or even for high-benzene gasolines if an adequately conservative, target risk is not applied to individually targeted

chemicals. This necessitates a re-evaluation of the reliance on benzene and other individual compounds as a stand-alone tool to evaluate vapor intrusion risk associated with petroleum.

**Keywords:** petroleum; TPH; carbon ranges; benzene; soil gas; soil vapor; vapor intrusion; risk assessment

## 1. Introduction

Much emphasis has been placed in the past ten-plus years on the potential intrusion of chlorinated solvent vapors into buildings from underlying contaminated soil and groundwater. The study of vapor intrusion associated with subsurface releases of petroleum fuels is, in comparison, still in its infancy. The complex chemistry of petroleum fuels and the difficulty of predicting the fate and transport of vapors in the subsurface hamper the development of easy-to-use guidance that can be applied under multiple site scenarios. This paper addresses the first issue. Other efforts are currently underway to compile field data and address the second topic.

Petroleum-contaminated soil and groundwater are traditionally assessed in terms of Total Petroleum Hydrocarbons (TPH) and targeted, individual compounds such as benzene, toluene, ethylbenzene, xylenes and naphthalene (BTEXN). The buildup of methane vapors at petroleum-release sites can also pose potential fire and explosion hazards. This topic is beyond the scope of this paper, however. As noted in Table 1, non-specific, aliphatic and aromatic compounds collectively quantified as TPH make up the overwhelming mass of liquid fuels. Risk-based assessment of TPH in soil is well established and in use in numerous states [1–9]. While relatively straight forward, the quantitative inclusion of TPH in vapor intrusion investigations is less-well established and few papers and guidance documents have been published on this topic [10,11]. Some states require an assessment of potential vapor intrusion hazards associated with both TPH and individually targeted compounds at sites where long-term, *in situ* management of petroleum-contaminated soil or groundwater is proposed [12].

**Table 1.** Range of current and past BTEX and naphthalene (BTEXN) concentrations in petroleum fuels.

Chemical	Gasolines <sup>1</sup>	Diesel <sup>2</sup>	Residual Fuels <sup>3</sup>
Benzene	0.1–4.9%	0.003–0.1%	0.06–0.1%
Ethylbenzene	0.1–3%	0.007–0.2%	
Toluene	1–25%	0.007–0.7%	0.1–0.2%
Xylenes	1–15%	0.02–0.5%	0.2–0.3%
Naphthalene	<1%	0.01–0.8%	

<sup>1</sup> Gasoline ranges after [1,13,14]; <sup>2</sup> Diesel #2 [1]; <sup>3</sup> Lubricating and motor oil [1].

This paper considers a series of key questions related to potential vapor intrusion concerns posed by TPH in contaminated soil and groundwater: (1) “How are the chemistry and toxicity of petroleum vapors characterized and evaluated?”; (2) “What is the composition of vapors emitted from fresh fuels and petroleum-contaminated soil and groundwater in terms of TPH and traditionally targeted,

individual compounds such as BTEXN?"; (3) "What is the chemical makeup of the TPH component of these vapors in terms of aliphatic and non-BTEXN aromatic carbon ranges?"; (4) "What is the toxicity of the TPH in terms of the weighted, carbon range composition?"; (5) At what critical ratio of TPH to an individual compound will the former begin to drive relative vapor intrusion risk over the latter, due to its overwhelming dominance of soil vapors?"; (6) "Under what site scenarios might vapor intrusion be driven by TPH rather than a individual compound such as benzene?"

The methodology described in this paper consists of six components: (1) Categorization of petroleum fuels into broad types based on the number of carbon atoms in compounds that typify the fuels, (2) Characterization of the non-BTEXN, TPH component of the fuels in terms of aliphatic and aromatic "carbon ranges", (3) Assignment of inhalation toxicity factors to volatile carbon ranges, (4) Calculation of risk-based, carbon range screening levels for indoor air and soil vapor, (5) Calculation of weighted screening levels for TPH based on the carbon range makeup of petroleum vapors, and (6) Calculation of the "critical ratio" of TPH in soil vapor to an individual chemical (e.g., benzene), at which point TPH will drive vapor intrusion risk over the individual compound even when a conservative, target risk is applied to the latter. These tools are then applied to two example sets of soil vapor data, the first associated with releases of gasolines and the second from sites associated with releases of middle distillates. The results are used to evaluate the relative role of TPH in vapor intrusion in comparison to traditionally targeted compounds such as benzene.

## 2. Methods

### 2.1. Categorization of Fuel Types

Petroleum fuels can be broadly categorized as "gasolines", "middle distillates" and "residual fuels", following the methodology used by the American Petroleum Institute [15]. The chemistry of these fuels has been extensively studied [1,16]. These categories in part reflect the number of carbon atoms in individual compounds that characterize the fuels (Figure 1). Compounds with less than approximately sixteen carbon atoms are considered to be "volatile" to "semi-volatile," with a propensity to partition into the vapor phase under ambient conditions. These compounds, which include a host of short-chain, aliphatic chemicals collectively measured as "TPH" as well as aromatic chemicals such as benzene, toluene, ethylbenzene, xylenes and naphthalene, are the primary target of vapor intrusion investigations. A summary of the BTEXN composition of petroleum fuels is provided in Table 1. Non-specific, TPH aliphatic and aromatic compounds comprise the remainder of the fuels.

Gasolines, including automotive gasoline and older jet fuels such as AVGAS, are dominated by "lighter" compounds with six to twelve carbon atoms. This causes gasolines to be highly volatile in comparison to other types of fuels. The amount of benzene, toluene, ethylbenzene and xylenes in gasolines can vary dramatically, from just a few percent to greater than 20%, depending on the refiner, the desired performance of the fuel and the historical time period that the fuel was produced (see Table 1). The benzene content of automotive gasolines can in particular vary significantly, from less than 0.1% to greater than 5% [14]. Recent regulations in the United States limit the average amount of benzene in gasolines to less than one-percent after the year 2011 in order to reduce health effects from exposure to

vapors and exhaust [17,18]. Older formulations of jet fuels and aviation gasoline likewise contained a relatively minor amount of benzene [13].

**Figure 1.** Composition of typical petroleum fuels with respect to the number of carbon molecules in individual compounds.

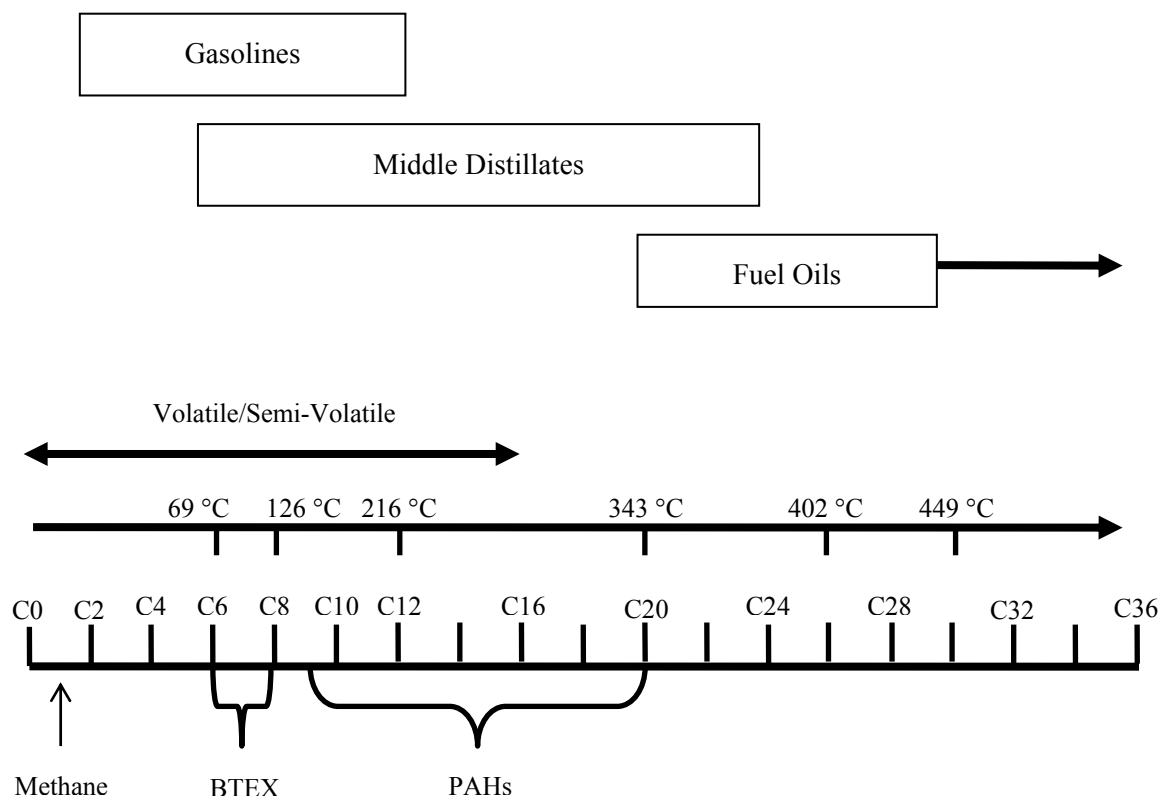

Middle distillate fuels (e.g., diesel, kerosene, JP-8 jet fuel, *etc.*) are dominated by hydrocarbon compounds with approximately nine to twenty-five carbon atoms and a relatively minor fraction of BTEX (see Table 1). Naphthalene, a suspected carcinogen, can comprise up to one-percent of these fuels. As a result, these fuels are less volatile than gasolines. Middle distillate fuels do, however, include a minor but important component of lighter and more volatile aliphatic compounds and, to a lesser extent, aromatic compounds. As discussed below, these aliphatic compounds not surprisingly dominate vapors emitted from these fuels under ambient conditions. Older jet fuels such as JP-4 are a mixture of gasoline and kerosene and again, while less volatile than gasolines, display a distinct vapor phase that is dominated by lighter-range aliphatic and aromatic compounds.

Residual fuels (e.g., Fuel Oil Nos. 4, 5, and 6, lubricating oils, “waste oils”, asphalts, *etc.*) are characterized by complex, polar PAHs and other high molecular weight hydrocarbon compounds with carbon ranges that generally fall between C24 and C40. Residual fuels lack a significant amount of volatile compounds (e.g., see Table 1) and, aside from the potential generation of methane, are generally assumed to pose a minimal vapor intrusion risk. This subsequent focus of this paper will therefore be on vapors associated with gasolines and middle distillate fuels.

## 2.2. Characterization Total Petroleum Hydrocarbons Using Carbon Ranges

Understanding the chemical makeup of the TPH component of petroleum fuels and more importantly the vapors emitted from these fuels is important, first step to evaluate the role of these compounds in vapor intrusion. Petroleum is a complex mixture of hundreds of different compounds composed of hydrogen and carbon or “hydrocarbons”. These compounds can be collectively grouped into “aromatic” and “aliphatic” carbon ranges, based in part on the number of carbon atoms in each compound [1].

Compounds formed by single or multiple, six-carbon rings are referred to as “aromatic”. Aromatic compounds include the familiar chemicals benzene, toluene, ethylbenzene and xylenes (BTEX) as well as naphthalene and other “polyaromatic” hydrocarbons. A small percentage of additional, aromatic compounds are included in the TPH component of fuels. These include alkylated compounds such as trimethylbenzene, which although sometimes reported by laboratories as part of an environmental investigation are not traditionally evaluated in human health and ecological risk assessments as individual chemicals.

Compounds formed by chains or non-aromatic rings of carbon and hydrogen are referred to as “aliphatic” and include such chemicals as pentane, hexane and octane. These compounds make up the bulk of petroleum fuels [1]. A host of additional terms are used to classify aliphatic compounds in more detail, depending for example on the presence or absence of ring structures, nature of carbon bonds, saturation with hydrogen and overall chemical structure (e.g., “alkanes”, “alkenes”, “olefins” and “cycloalkanes”, *etc.*).

Evaluation of each individual, TPH-related aromatic and aliphatic compound as part of an environmental investigation is not feasible or practical due to the large number of compounds involved and the lack of physiochemical and toxicological information for these chemicals. The TPH component of petroleum is instead evaluated in terms of “carbon ranges” of aliphatic and aromatic compounds. Carbon ranges are defined by groups of aliphatic or aromatic compounds that exhibit similar physiochemical and, presumably, toxicological characteristics. Carbon range fractions designated by Massachusetts are the most commonly referenced in the United States (see Figure 1) [19]:

- C5-C8 aliphatics;
- C9-C12 aliphatics;
- C13-C18 aliphatics;
- C19-C36 aliphatics;
- C9-C10 aromatics;
- C11-C22 aromatics.

These carbon range groups represent a consolidation and simplification of a larger number of ranges originally published by the TPH Criteria Working Group, an environmental consortium of regulators, consultants and oil company experts convened to develop a more comprehensive, risk-based approach for the evaluation of petroleum-contaminated soil and groundwater [20]. This was done in part on available toxicity factors for individual ranges. Compounds that fall within the C5-C8 aliphatic carbon range are the most volatile, although C9-C12 aliphatics and C9-C10 aromatics also fall in this category. Compounds that fall within the C13-C18 aliphatic and C11-C22 aromatic carbon ranges are

considered to be “semi-volatile.” Aliphatic compounds with greater than 18 carbon atoms and aromatic compounds with greater than ten carbon atoms are not considered to be volatile. Carbon ranges can also be defined in terms of “Equivalent Carbons,” based on the boiling point of individual compounds [5,20].

As discussed below, assignment of physiochemical and toxicological parameter values to individual carbon ranges allows for quantitative inclusion of TPH in environmental risk assessments in the same manner as individual compounds. This includes the development of risk-based screening levels for water, soil, soil vapor and indoor air. This approach was first developed by the Total Petroleum Hydrocarbon Criteria Working Group [20]. Guidance on the use of carbon-range approaches to quantitatively evaluate the non-BTEX, TPH component of petroleum-contaminated media was subsequently developed by a number of state agencies (e.g., [2–6,8,9]).

The bulk chemistry of petroleum fuels in terms of TPH carbon ranges and commonly targeted, individual, aromatic compounds is summarized in Table 2 (after [2,21]). Aliphatic compounds dominate both the TPH and overall component of petroleum fuels. Gasolines are dominated by C5-C8 aliphatics and C9-C12 aromatics, although the proportion of the latter can vary widely depending on the fuel blend. Residual fuels are dominated by longer-chain aliphatics and a lesser amount of polyaromatic hydrocarbons.

**Table 2.** Example carbon range makeup of non-BTEXN, TPH component of petroleum fuels (exact carbon range makeup of individual fuels will vary).

Carbon Range	Gasolines <sup>1</sup>	Diesel <sup>1</sup>	Residual Fuels <sup>2</sup>
C5-C8 aliphatics	45%	<1%	<1%
C9-C18 aliphatics	12%	35%	<1%
C19+ aliphatics	<1%	43%	75%
C9-C12+ aromatics	43%	22%	25%

<sup>1</sup> Indiana Department of Environmental Management [21]; <sup>2</sup> Massachusetts Department of Environmental Protection [2].

Physiochemical constant values published by Massachusetts [2], currently most in use in the US, are summarized in Table 3. Values for BTEX and naphthalene are included for comparison [22]. The chemical makeup of vapors emitted from petroleum fuels is predictable based on the composition of the fuels and the theoretical partitioning of chemicals into sorbed, dissolved and vapor phases upon release to the environment [23]. Vapors emitted from fresh gasolines can be predicted to be dominated by C5-C8 aliphatics (and C2-C4 aliphatics, if present) based both on the abundance and relative volatility of these compounds, with a variable but lesser amount of BTEX and other aromatic compounds depending on the specific fuel blend (see also [24] and [25]). While less volatile than gasolines, diesel and other middle distillate fuels contain variable amounts of C5-C8 aliphatics and a relatively large component of C9-C18 aliphatics (see Table 2). These compounds should again dominate vapors emitted from the fuels. The relative proportion of C5-C8 to C9-C12 aliphatics in vapors will depend in part on the original composition of the fuel (see also [26]). The fraction of BTEX in the vapors should be significantly smaller than for gasolines, given their lower relative abundance.



This general makeup of petroleum vapors is indeed observed in the case studies presented later in this paper. As discussed in the case studies, soil vapor samples from some of the middle distillate-release sites contain a significant proportion of C5-C8 “gasoline-range” compounds. Requesting a lab to test a sample for “diesel-range” hydrocarbons as the sum of C9 and higher compounds is reasonable for soil, since this fraction dominates the liquid fuel and should similarly dominate the TPH present in the soil. Requesting that TPH be quantified in terms of traditional, diesel-range compounds for soil vapor could result in a significant underreporting of the total TPH present, however. Laboratories should instead be requested to report TPH in soil vapors simply as the sum of C5 to C12 hydrocarbons for both gasoline- and middle distillate-contaminated sites. Testing for additional, heavier vapor-phase compounds (e.g., C13+ aliphatics) may also be necessary. This is discussed further in the following section, as well as in the example case studies.

**Table 3.** Default physiochemical constants for BTEXN and TPH carbon ranges.

Chemical/Carbon Range <sup>1</sup>	Molecular Weight	Vapor Pressure (atms)	Solubility in Water (mg/L)	Henry's Constant (unitless)	Partition Coeff, $k_{oc}$ (cm <sup>3</sup> /g)	Diffusion Coefficient (cm <sup>2</sup> /s)	
						air	water
Benzene	78	0.1	1,790	0.23	146	0.09	$1 \times 10^{-5}$
Ethylbenzene	106	0.01	169	0.32	446	0.068	$8.5 \times 10^{-6}$
Toluene	92	0.04	526	0.27	234	0.078	$9.2 \times 10^{-6}$
Xylenes	106	0.01	161	0.29	375	0.068	$8.4 \times 10^{-6}$
Naphthalene	128	$1.0 \times 10^{-4}$	30	0.018	1,540	0.06	$8.4 \times 10^{-6}$
C5-C8 Aliphatics	93	0.1	11	54	2,265	0.08	$1 \times 10^{-5}$
C9-C12 Aliphatics	149	$8.7 \times 10^{-4}$	0.07	65	150,000	0.07	$1 \times 10^{-5}$
C13-C18 Aliphatics	170	$1.4 \times 10^{-4}$	$3.5 \times 10^{-4}$	69	680,000	0.07	$5.0 \times 10^{-6}$
C19-C36 Aliphatics	280	$1.1 \times 10^{-6}$	$1.5 \times 10^{-6}$	110	$4.0 \times 10^{-9}$		
C9-C10 Aromatics	120	$2.9 \times 10^{-3}$	51	0.33	1,778	0.07	$1 \times 10^{-5}$
C11-C22 Aromatics	150	$3.2 \times 10^{-5}$	5.8	0.03	5,000	0.06	$1 \times 10^{-5}$

<sup>1</sup> Constants for BTEXN from USEPA RSL guidance [22]; vapor pressures from TOXNET [27]; Carbon range values from Massachusetts DEP [2] except C13-C18 Aliphatics (based on EC > 12–16) and C19-C36 Aliphatics (based on EC > 16–35 aliphatics) [20].

### 2.3. Assignment of Inhalation Toxicity Factors to Carbon Ranges

Key to the risk-based assessment of TPH in vapor intrusion investigations is the assignment of inhalation toxicity factors or “Reference Concentrations (RfC)” to individual, volatile carbon ranges. A summary of published inhalation toxicity factors for carbon ranges is presented in Table 4. Lower RfCs reflect progressively increasing toxicity (*i.e.*, less of the chemical is required to result in a health effect).

The TPH Criteria Working Group published an extensive overview of the carbon range chemistry of petroleum fuels in the late 1990s and assigned preliminary toxicity factors to each fraction [28]. The US Department of Health and Human Services quickly published updated guidance in 1999 [29]. The Massachusetts Department of Environmental Protection published initial guidance during the same time period and last updated their factors for carbon range fractions in 2003 [19]. The Washington Department of Ecology published toxicity factors for TPH carbon ranges in 2005 and 2006 [5]. In 2009, the California EPA Department of Toxics Substances Control published guidance

and proposed toxicity factors similar to those proposed by MADEP [30]. The USEPA National Center for Environmental Assessment published a detailed review of TPH carbon range toxicity and recommended Provisional Peer-Reviewed Toxicity Values (PPRTVs) in 2009 [16].

**Table 4.** Published inhalation toxicity factors for petroleum aliphatic and aromatic carbon ranges (listed in order of publication).

Reference	RfC (mg/m <sup>3</sup> )	RfC (µg/m <sup>3</sup> )
TPH Criteria Working Group [28]		
(C5-C8) Aliphatics	18.4	18,400
(C9-C18) Aliphatics	1.0	1,000
(C9-C16) Aromatics	0.2	200
USDHHS <sup>1</sup> [29]		
(C5-C8) Aliphatics	2.2	2,200
(C9-C18) Aliphatics	0.3	300
(C9-C16) Aromatics	0.01	10
Massachusetts DEP [19]		
(C5-C8) Aliphatics	0.2	200
(C9-C18) Aliphatics	0.2	200
(C9-C18) Aromatics	0.05	50
Washington DOE <sup>2</sup> [5]		
(C5-C8) Aliphatics	6.0	5,950
(C9-C16) Aliphatics	0.3	298
(C9-C10) Aromatics	0.399	399
(C11-C12) Aromatics (naphthalene)	0.003	3.0
(C13-C16) Aromatics	0.2	175
CalEPA-DTSC <sup>3</sup> [30]		
(C5-C8) Aliphatics	0.7	700
(C9-C18) Aliphatics	0.3	300
(C9-16) Aromatics	0.05	50
USEPA <sup>4</sup> [16]		
(C5-C8) Aliphatics (noncancer)	0.6	600
(C9-C18) Aliphatics	0.1	100
(C9-C16) Aromatics	0.1	100

<sup>1</sup> ATSDR C5-C8 aliphatics RfC converted to 2.2 mg/m<sup>3</sup> from 0.6 ppm based on hexane molecular weight of 86; C9-C16 aromatics RfC converted to 0.01 mg/m<sup>3</sup> from 0.002 ppm based on naphthalene molecular weight of 128;

<sup>2</sup> Washington DOE Inhalation Reference Dose extrapolated to a Reference Concentration: using RfC (mg/m<sup>3</sup>) = RfD (mg/kg-day) × 70 kg × (1/20m<sup>3</sup>-day); <sup>3</sup> California EPA toxicity factors withdrawn in 2010 pending review of additional data; <sup>4</sup> USEPA toxicity factors selected for calculation of risk-based indoor air and soil vapor screening levels.

The variability of published toxicity factors for individual carbon ranges is important, since this directly affects the estimated risk (or more appropriately noncancer hazard) posed by TPH in a vapor intrusion study. Of particular interest is the RfC assigned to C5-C8 aliphatics, since as discussed above and noted in case studies below, these compounds tend to dominate the TPH component of petroleum vapors. For example, the inhalation RfC published by USEPA (600 µg/m<sup>3</sup>) is less conservative (*i.e.*, higher) than the correlative toxicity factor published by Massachusetts (200 µg/m<sup>3</sup>) but an order of magnitude or more lower than toxicity factors published by the State of Washington (equal to 5,950 µg/m<sup>3</sup>) and the earlier toxicity factor the TPH Criteria Working Group (18,400 µg/m<sup>3</sup>).

Based on a review of published guidance, the State of Hawaii [8] opted to incorporate PPRTVs for volatile carbon ranges published by the USEPA [16]. Conclusions drawn from the case studies

presented would necessarily differ based on the toxicity factors selected for the carbon ranges. Full consensus is rarely if ever reached on toxicity values for specific chemicals, however, including toxicity factors posted to USEPA's IRIS database—considered to be the most supportable and defensible database available. States as well as USEPA routinely draw on available information for assessment of the health risk posed by chemicals that are not currently listed in IRIS. Indeed, Regional Screening Levels published in USEPA's guidance document are based in part or entirely on PPRTV toxicity factors for over one-hundred of the chemicals listed [22].

A summary of the PPRTV inhalation toxicity factors [16] for carbon ranges and inhalation toxicity factors for BTEXN is provided in Table 5. The toxicity factors address systemic, noncancer health hazards. Cancer risk is assumed to be driven by well-studied, individual compounds such as benzene, ethylbenzene and naphthalene [8,22].

**Table 5.** Inhalation toxicity factors for targeted VOCs and carbon range fractions.

Chemical	IUR <sup>1</sup> ( $\mu\text{g}/\text{m}^3$ ) <sup>-1</sup>	RfC <sup>2</sup> ( $\mu\text{g}/\text{m}^3$ )
Benzene	7.8E-06	30
Ethylbenzene	2.5E-06	1,000
Toluene		5,000
Xylenes		100
Naphthalene	3.4E-05	3.0
C5-C8 aliphatics		600
C9-C18 aliphatics		100
C9+ aromatics		100

<sup>1</sup> Inhalation Unit Risk [22]; <sup>2</sup> Reference Concentration; BTEXN RfCs from USEPA [22]; Carbon Range RfCs from USEPA [16].

#### 2.4. Calculation of Risk-Based Air and Soil Vapor TPH Screening Levels

Calculation of risk-based screening levels for TPH in indoor air and soil vapor or direct inclusion in human-health risk assessments is relatively straight forward following assignment of inhalation toxicity factors to volatile carbon ranges. Accurate quantitative evaluation of vapor intrusion risks based on soil and groundwater data is much more difficult, as discussed earlier, due to the variability of biodegradation and attenuation processes on a site-by-site basis. This likewise impedes the development of meaningful TPH screening levels for other than subslab or very shallow soil vapors [8]. The collection of sub-slab soil vapor samples helps to minimize uncertainty regarding the fate and transport of petroleum vapors in the subsurface, since these vapors can be assumed to undergo minimal, additional attenuation prior to intruding into an overlying building.

For the purposes of this paper, the PPRTV toxicity factors published by the USEPA in 2009 [16] were selected for calculation of example, indoor air and subslab soil vapor screening levels for individual carbon ranges (see Table 4). The development of indoor air and subslab, soil vapor screening levels for vapor intrusion can be condensed into three relatively simple steps: (1) Calculation of a target indoor-air goal based on the assigned toxicity factor and default exposure assumptions (e.g., exposure frequency and duration); (2) Assignment of an indoor air: subslab soil vapor attenuation

factor based on a comparison of vapor flow rates into a building and air flow rates through the building and (3) Calculation of a soil vapor screening level. A summary of these steps is provided below.

Indoor air screening levels can be calculated using the ambient air equations presented in the USEPA Regional Screening Level guidance [22]:

$$\text{Carcinogens: } C_{ia} = \frac{TR \times ATc \times 365 \text{ days/year}}{IUR \times EF \times ED} \quad (1)$$

$$\text{Noncarcinogens): } C_{ia} = \frac{TR \times ATnc \times 365 \text{ days/year}}{\frac{1}{RfC} \times EF \times ED} \quad (2)$$

where:

$C_{ia}$  = Indoor air concentration ( $\mu\text{g}/\text{m}^3$ );

TR = Cancer Target risk ( $10^{-6}$ , unitless);

THQ = Noncancer Target Hazard Quotient (1.0, unitless);

ATc = Carcinogen Averaging Time (70 years);

ATnc = Noncancer Averaging time (30 years);

IUR = Cancer Inhalation Unit Risk (chemical-specific,  $(\mu\text{g}/\text{m}^3)^{-1}$ )

RfC = Noncancer Reference Concentration (chemical-specific,  $\mu\text{g}/\text{m}^3$ );

EF = Exposure frequency (350 days/year); and

ED = Exposure duration (30 years).

Default exposure and target risk parameter values used for calculation of the indoor air screening levels are noted above and based on residential exposure assumptions used for development of the USEPA RSLs [22].

Example indoor-air screening levels for BTEX, naphthalene and carbon ranges based on the above equations and exposure assumptions and toxicity factors noted in Table 4 are presented in Table 6. Noncancer screening levels for benzene, ethylbenzene and naphthalene are not shown, since they would be higher than and over ridden by cancer-based screening levels. A target excess cancer risk was of  $10^{-6}$  was used for carcinogenic VOCs. A target Hazard Quotient of 1.0 was used for noncancer-based screening levels. Note that these screening levels do not directly take into account cumulative risk posed by the potential presence of other chemicals with similar health effects. This is less of an issue for screening levels based on cancer risk, since they are set at the most conservative end of the target risk range of  $10^{-4}$  to  $10^{-6}$ . Consideration of potential cumulative risk is especially important for screening levels based on noncancer concerns, however, since no safety margin is included (*i.e.*, maximum target Hazard Index often set at 1.0) [22].

Calculation of a subslab soil vapor-to-indoor air attenuation factor (AF) essentially reduces to:

$$AF(\text{unitless}) = \frac{\text{Vapor Flux Rate}}{\text{Vapor Flux Rate} + \text{Indoor Air Exchange Rate}} \quad (3)$$

For the purposes of this paper, indoor air-soil vapor attenuation factors of 0.001 (residential scenario) and 0.0005 (commercial/industrial scenario) published by the state of Hawaii were referred to for calculation of soil vapor screening levels [8]. These attenuation factors are based on building

ventilation rates typical of tropical and Mediterranean climates and may not be appropriate for use in colder regions where buildings are heated for much of the year, but are adequate for demonstration purposes. The rapid breakdown of aliphatic compounds under aerobic conditions is anticipated to significantly lower the persistence of aliphatic compounds in indoor air in comparison to chlorinated solvents and play an important role in the reduction of long-term, vapor intrusion risk [31]. A detailed discussion of this issue is beyond the scope of this paper, however, and the noted attenuation factors are presented for use as examples only.

**Table 6.** Example indoor air and subslab, soil vapor screening levels for petroleum-related chemicals.

Chemical	Indoor Air <sup>1</sup>		Subslab Soil Vapor <sup>2</sup>	
	Residential ( $\mu\text{g}/\text{m}^3$ )	Commercial/Industrial ( $\mu\text{g}/\text{m}^3$ )	Residential ( $\mu\text{g}/\text{m}^3$ )	Commercial/Industrial ( $\mu\text{g}/\text{m}^3$ )
Benzene	0.31	1.6	310	3,200
Ethylbenzene	0.97	4.9	970	9,800
Toluene	5,200	22,000	5,200,000	44,000,000
Xylenes	100	440	100,000	880,000
Naphthalene	0.072	0.36	72	720
C5-C8 aliphatics	630	880	630,000	1,760,000
C9-C18 aliphatics	100	150	100,000	300,000
C9-C16 aromatics	100	150	100,000	300,000

<sup>1</sup> Based on target cancer risk of  $10^{-6}$  (benzene, ethylbenzene, naphthalene) or noncancer Hazard Quotient of 1.0 (toluene, xylenes and carbon range compounds); <sup>2</sup> Based on indoor air-soil vapor (subslab) attenuation factors of 0.001 for residential structures and 0.0005 for commercial/industrial structures (after [8]; for example only).

Soil-gas screening levels ( $C_{\text{sg}}$ ) are subsequently calculated as:

$$C_{\text{sg}} = \frac{\text{Indoor Air Goal}}{\text{AF}} \quad (4)$$

Example subslab soil-gas screening levels for BTEXN and volatile aliphatic and aromatic carbon ranges, and TPH using the above approach are included in Table 6.

Screening levels for C5-C8 aliphatics are the least stringent of the carbon range compounds (e.g., indoor air screening level  $630 \mu\text{g}/\text{m}^3$ ), reflecting the higher inhalation Reference Concentration assigned to this fraction of  $600 \mu\text{g}/\text{m}^3$ . Screening levels for C9-C18 aliphatics and C9-C16 aromatics are most stringent, reflecting the lower Reference Concentration of  $100 \mu\text{g}/\text{m}^3$  common to both fractions and generating an identical indoor air screening level of  $100 \mu\text{g}/\text{m}^3$ , after rounding. The screening levels are based on a target, noncancer hazard quotient of 1.0.

The example soil-gas screening levels do not take into account an expected decrease in vapor concentrations over time due to biodegradation and source area depletion and can be overly conservative for sites with limited contamination. Mass-balance approaches can be used to estimate maximum, average vapor concentrations over the assumed exposure duration based on an estimate of the mass of the chemical present in the source area.

As discussed later in this paper, a comparison of TPH carbon range screening levels to screening levels for individual compounds provides a useful tool to determine if the former might drive vapor

intrusion risk over the latter at a site. Calculation and use of a single, TPH screening level weighted with respect to the representative (or assumed), carbon range makeup of petroleum vapors at a site will significantly speed up this process, however, and avoid the need to collect expensive carbon range data for every sample. Variability in TPH composition within a site due to biodegradation and other factors that affect partitioning (e.g., soil moisture and organic carbon content) can complicate this assessment, however. In these cases use of the most conservative, weighted RfC calculated for the site may be warranted.

### 2.5. Calculation of Weighted, TPH Screening Levels

The use of TPH soil vapor data is generally preferable for initial screening of petroleum-contaminated sites due to the added cost and the currently limited number of laboratories that can provide vapor-phase carbon range data. The following equation can be used to calculate weighted inhalation Reference Concentration (RfC) for TPH based on the site-specific carbon range makeup of TPH in soil vapor or indoor air [8,10]:

$$\text{Weighted RfC} \left( \frac{\mu\text{g}}{\text{m}^3} \right) = \frac{1}{\left[ \left( \frac{\text{Fraction C5 - C8 Aliphatics}}{\text{C5 - C8 Aliphatics RfC}} \right) + \left( \frac{\text{Fraction C9 - C18 Aliphatics}}{\text{C9 - C18 Aliphatics RfC}} \right) + \left( \frac{\text{Fraction C9 - C16 Aromatics}}{\text{C9 - C16 Aromatics RfC}} \right) \right]} \quad (5)$$

This approach can be used to calculate weighted TPH toxicity factors (RfCs) and associated indoor air and soil vapor screening levels based on either site-specific data or an assumed, carbon range makeup of TPH vapors for a specified fuel type.

Very few studies have been published regarding the detailed, carbon range makeup of vapors from common petroleum fuels. Carbon range data presented in the USEPA Petroleum Vapor Intrusion (PVI) database were used to approximate the chemistry and ultimately the weighted toxicity of TPH vapors associated with gasolines (see paper Supplementary Material) [32]. The database is intentionally biased toward gasoline-contaminated sites, although as noted later in this paper significantly high TPH:Benzene ratios for some samples suggest that data from diesel-contaminated sites may also be included.

For illustration purposes in this paper, the average carbon range makeup of the data presented in the USEPA database was used to approximate the carbon range makeup of gasoline vapors in general. The review was limited to samples from gasoline-only sites with paired TPH and benzene data and reported concentrations of TPH >1,000  $\mu\text{g}/\text{m}^3$ . The latter filter was included in order to limit potential biases due to laboratory detection limits or interference from background, petroleum vapors associated with unrelated, indoor or outdoor sources [2]. Apparent duplicate sample data for some sites was also ignored (*i.e.*, identical concentrations of TPH and benzene). A total of 364 samples from 48 sites met these criteria (see paper supplement). Carbon range data were included for 35 samples from ten of the original 48 sites. The average carbon range composition of TPH in the samples is 77.3% C5-C8 aliphatics, 15.4% C9-C12 aliphatics and 7.3% C9-C10 aromatics. The aliphatic and aromatic makeup of the samples spans a broad range, with the median composition more biased toward C5-C8 aliphatics than the mean composition. The proportion of C5-C8 aliphatics in the samples ranges from 12% to 100%,

with a median of 88%. The proportion of C9-C12 aliphatics ranges from 0% to 77%, with a median of 10%. The proportion of C9-10 aromatics ranges from 0% to 55%, with a median of median 2%.

For the purposes of this example, the average carbon range makeup of the samples in the USEPA PVI database report [32] was used to generate a weighted, TPH RfC for gasoline vapors of 279 µg/m<sup>3</sup> using Equation 5 above:

$$\text{Weighted RfC} = \frac{1}{\left[\left(\frac{0.773}{600}\right) + \left(\frac{0.154}{100}\right) + \left(\frac{0.073}{100}\right)\right]} = 279 \mu\text{g}/\text{m}^3 \tag{6}$$

Risk-based screening levels and associated “critical ratios” for TPH vapors associated with gasoline (TPHg) based on this example RfC are used later in this paper to evaluate a soil vapor database for gasoline-contaminated sites published by the USEPA.

Even less data are available for the carbon range makeup of vapors from diesel and other middle distillates. A limited, field study by the Hawaii Department of Health (HDOH) identified a highly variable composition of vapors for diesel fuels and jet fuels, with C5-C8 aliphatics dominating at some sites and C9-C12 aliphatics dominating at others [10]. Data from this study are discussed later in this paper. The study intentionally focused on diesel- and middle distillate-contaminated sites, as a compliment to the developing, USEPA database for gasoline-contaminated sites. Sorbent tube data suggested an insignificant amount of C13-C18 aliphatics and C11-C16 aromatics in the samples. For the purposes of this paper, the hypothetical TPH composition for diesel and other middle distillate vapors of 25% C5-C8 aliphatics, 75% C9-C12 aliphatics and 0% C9-C16 aromatics adopted by HDOH for use in their guidance was selected. This generates a carbon range-weighted, TPH RfC for middle distillate vapors (TPHd) of 130 µg/m<sup>3</sup>:

$$\text{Weighted RfC} = \frac{1}{\left[\left(\frac{0.25}{600}\right) + \left(\frac{0.75}{100}\right) + \left(\frac{0.00}{100}\right)\right]} = 130 \mu\text{g}/\text{m}^3 \tag{7}$$

Note that the HDOH study did not identify a significant proportion of aliphatic compounds greater than C12 and aromatic compounds greater than C10 at any of the sites investigated. Laboratory-based studies have suggested a dominance of heavier compounds in vapors from some middle distillate fuels, however [26]. This would not significantly alter the weighted RfC for middle distillate vapors, since the toxicity of these compounds is assumed to be identical to medium-weight aliphatics and aromatics (see Table 4).

**Table 7.** Example, indoor air and soil vapor screening levels for TPH based on default, carbon range compositions for gasolines and middle distillates noted in text.

Fuel Type	Weighted RfC (µg/m <sup>3</sup> )	Indoor Air <sup>1</sup>		Subslab Soil Vapor <sup>2</sup>	
		Residential (µg/m <sup>3</sup> )	Commercial/Industrial (µg/m <sup>3</sup> )	Residential (µg/m <sup>3</sup> )	Commercial/Industrial (µg/m <sup>3</sup> )
Gasolines	279	290	410	290,000	810,000
Middle Distillates	130	140	190	140,000	380,000

<sup>1</sup> Based on noncancer Hazard Quotient of 1.0; <sup>2</sup> Based on indoor air-soil vapor (subslab) attenuation factors of 0.001 for residential structures and 0.0005 for commercial/industrial structures (for example only) (after [8]).

The weighted, TPH toxicity factors for gasoline and diesel vapors can now be used to calculate TPHg and TPHd screening levels for indoor air and soil vapor in the same manner as done for individual compounds. Total Petroleum Hydrocarbon screening levels based on the equations and exposure assumptions discussed earlier are presented in Table 7. These screening levels can now be used to estimate “critical ratios” where the proportion of TPH in vapors in comparison to individual, targeted compounds such as benzene reaches a point that TPH will drive vapor intrusion risk.

### 2.6. Calculation of TPH Critical Ratios

The relative risk posed by two (or more) different chemicals under a given exposure pathway (e.g., vapor intrusion) is in part a function of toxicity and concentration. Aliphatic compounds that dominate TPH are, for example, significantly less toxic than benzene at equivalent exposure concentrations. This can be seen by a simple comparison of indoor air and soil vapor screening levels for carbon ranges and benzene in Tables 6 and 7. At some “critical ratio”, however, the overwhelming proportion of TPH in the vapors will override the risk posed by benzene and TPH will “drive” vapor intrusion risk. (Note that the term “risk” is used in a generic fashion to denote “noncancer hazard” and/or “excess cancer risk.”)

This ratio represents the weighted, indoor air, TPH screening level calculated for the samples divided by the indoor air screening level for benzene. If the ratio of TPH to benzene in soil vapor measured in the field exceeds this value, then the concentration of TPH in indoor air (or soil vapor) would in theory still exceed its risk-based screening level even though the concentration of benzene was at or below its respective screening level. If the critical ratio is not exceeded, then the concentration of TPH in indoor air (or soil vapor) would be at or below its respective screening level when the screening level for benzene is met. In the first case, TPH can be said to “drive” vapor intrusion risk, since screening and/or remediation of a site to address TPH vapors would coincidentally address potential vapor intrusion risks posed by benzene. In the second case, benzene can be said to drive vapor intrusion risk (*i.e.*, potential vapor intrusion risks posed by TPH would be adequately addressed at the point that the risk posed by benzene is addressed. This assumes, among other factors, that the average ratio of TPH to benzene calculated for the samples reflects the ratio in subslab soil vapor at the point that vapors intrude an overlying building.

As noted in Table 6, screening levels for TPH in indoor air or soil vapor can be up to 2,032 times higher than screening levels for benzene (e.g., C5-C8 aliphatic indoor air screening level of  $630 \mu\text{g}/\text{m}^3$  divided by benzene indoor air screening level of  $0.31 \mu\text{g}/\text{m}^3 = 2,032$ ). In this case, TPH will always drive vapor intrusion risk when the TPH:Benzenes ratio exceeds 2,032:1, even if a conservative, target risk of  $10^{-6}$  is applied to benzene. Similarly, screening levels for TPH can be almost 8,750 times higher than screening levels for naphthalene (*i.e.*, maximum TPH indoor air screening level of  $630 \mu\text{g}/\text{m}^3$  divided by minimum naphthalene indoor air screening level of  $0.072 \mu\text{g}/\text{m}^3$ ). This ratio will decrease as the proportion of longer-range aliphatics in petroleum vapors increases, along with the toxicity of the TPH vapors in general (*i.e.*, less TPH required to drive vapor intrusion risk over individual compounds).



Table 8 presents a summary of critical ratios for TPH and individual compounds based on the example, indoor air and soil vapor screening levels presented in Tables 6 and 7 and the assumed, carbon range makeup of TPH vapors for gasoline and middle distillate fuels presented in Table 2.

**Table 8.** Example critical ratios over which TPH in soil vapor will drive vapor intrusion risk over individual compound.

Chemical	Critical Ratio <sup>1,2</sup>	
	TPH Gasoline Vapors	TPH Middle Distillate Vapors
Benzene	935	452
Ethylbenzene	299	144
Toluene	0.06	0.03
Xylenes	2.9	1.4
Naphthalene	4,028	1,944

<sup>1</sup> TPH vapor intrusion screening level (Table 7) divided by individual compound screening level (Table 6);

<sup>2</sup> Ratio at which TPH will exceed vapor intrusion screening level when individual compound is at or below its respective screening level (based on a target cancer risk of  $10^{-6}$  or a noncancer Hazard Quotient of 1.0).

A critical ratio of 935:1 ( $290 \mu\text{g}/\text{m}^3/0.31 \mu\text{g}/\text{m}^3$ ) is generated for TPH:Benzenes, based on an assumed TPH vapor composition of 75% C5-C8 aliphatic compounds and 25% C9-C12 aliphatic plus aromatic compounds. The TPH critical ratios are reduced by a factor of two for vapors associated with diesel and other middle distillate fuels (*i.e.*, less TPH required to drive risk over individual compounds), based on an assumed TPH vapor composition of 25% C5-C8 aliphatic compounds and 75% C9-C12 aliphatic and C9-C10 aromatic compounds.

Default or site-specific critical ratios provide a very simple and quick tool to determine the potential significance of TPH as a vapor intrusion risk driver at a site where both TPH and benzene soil vapor data are available. For example, if the TPH:Benzenes ratio exceeds 2,032:1 at a site then TPH will *always* drive vapor intrusion risk over benzene, regardless of the carbon range makeup of the TPH (*i.e.*, even if TPH is composed of 100% C5-C8 aliphatics) and even if a conservative, excess cancer risk of  $10^{-6}$  is applied to benzene. The same is true when the TPH:Naphthalene ratio exceeds 8,750:1. In such cases, TPH vapors could still pose a vapor intrusion risk even though screening levels for individually targeted compounds are met. The lowest possible TPH:Benzenes critical ratio using a benzene target risk of  $10^{-6}$  is 323:1, based on a TPH vapor composition of 100% C9-C12+ aliphatics and/or C9-C10 aromatics (*i.e.*,  $100 \mu\text{g}/\text{m}^3$  divided by benzene indoor air screening level of  $0.31 \mu\text{g}/\text{m}^3$ ; see Table 6). In this example, TPH *could* drive vapor intrusion risk over benzene at a TPH:Benzenes ratio as low as 323:1, depending on the actual carbon range makeup and weighted toxicity of the TPH.

Similar, example critical ratios were calculated for other targeted compounds (*i.e.*, TEXN). The ratio increases for compounds that are more toxic than benzene (e.g., naphthalene critical ratio 8,750:1) and decreases for compounds that are less toxic (e.g., toluene critical ratio 0.06:1). In other words, a higher proportion of TPH in soil vapor (or indoor air) is required to overwhelm the vapor intrusion risk posed by an individual compound as the toxicity of the targeted compound increases.

The relative role of TPH in vapor intrusion risk will ultimately depend on the actual carbon range chemistry of the TPH and the associated toxicity and the target risk used to screen for individual compounds. Less TPH is required to overwhelm the risk posed by an individual chemical as the

proportion of more toxic, C9-C18 aliphatics (or C9-C16 aromatics) increases. Critical ratios are also necessarily dependent on the toxicity factors applied to individual, TPH carbon ranges. Toxicity factors published by the State of Massachusetts [19], for example, are more conservative than USEPA toxicity factors by a factor of two to three [16]. Critical ratios based on Massachusetts toxicity factors would be lower (*i.e.*, more conservative) by a similar amount.

In the next section of this paper, these screening tools are applied to the soil vapor database compiled by the USEPA and to a separate petroleum vapor study carried out by the State of Hawaii in order to evaluate the relative role of TPH in vapor intrusion at petroleum-contaminated sites. The first database focuses on soil vapor sample data from purported gasoline releases. The Hawaii study focuses primarily on soil vapor data from middle distillate releases, and serves as a supplement to the USEPA database.

### **3. Application of Method to Case Studies**

#### *3.1. Selection of Representative Case Studies*

In the previous sections we reviewed the basic chemistry and toxicity of petroleum vapors in terms of TPH carbon ranges and targeted, individual compounds such as benzene. We presented published toxicity factors for carbon ranges and summarized the approach for calculation of risk-based, indoor air and soil vapor screening levels, including screening levels for TPH in general. We then presented the concept of “critical ratios” of TPH to individual, targeted compounds that can be used to quickly assess the relative role of TPH in potential vapor intrusion threats on a site-by-site basis.

In the following discussions, we apply these tools to two sets of case studies for petroleum-contaminated sites in order to answer the ultimate question posed at the beginning of this paper: “Do field data support conditions where vapor intrusion concerns posed by petroleum could be driven by the TPH rather by individual compounds such as benzene?” Data are first screened in terms of TPH: Benzene ratios and the potential for TPH to play a significant role in vapor intrusion risk reviewed. The carbon range makeup of the TPH is then evaluated in more detail. Weighted, TPH reference doses are then used to calculate more site specific (or database-specific), TPH screening levels for indoor air and soil vapor and the data re-evaluated.

The first set of case studies reflect a soil vapor sample data set being compiled by the USEPA for primarily gasoline-contaminated sites. The second set of case studies and data are based on a study carried out by the State of Hawaii under a grant from the USEPA for sites contaminated with diesel and other middle distillate fuels. The sites included in the Hawaii study were targeted to fill in gaps in the USEPA database and more closely evaluate the potential for non gasoline-contaminated sites to pose potential vapor intrusion threats.

Both data sets focus primarily on the nature of petroleum vapors within the immediate vicinity of the source area (*i.e.*, within fifteen feet of contaminated soil or groundwater). The fate and transport of vapors at increasing distances from the source areas is not directly reviewed, although characteristics such as the ratio of TPH to key, indicator compounds such as benzene can shed light on this subject.

The reviews presented below are intended for illustration purposes only and are not intended to be a comprehensive evaluation of the sites involved. The USEPA data are, for example, summarized in

terms of individual sample points rather than the range and average for sites. This introduces a potential bias toward sites with a higher number of sample points in comparison to those with only a few sample points. For the purposes of this paper it is assumed that this bias is small and that the data in general are adequately representative.

### 3.2. Vapors Associated with Gasolines

As introduced earlier, the USEPA Office of Underground Storage Tanks (UST) has compiled a “Petroleum Vapor Intrusion” database of soil vapor data for seventy sites in the US, Canada and Australia [32]. The database focuses on known or presumed, gasoline-contaminated sites associated with releases from USTs. Although limited in terms of the total number of petroleum release sites in these countries, in the hundreds of thousands in the US alone, the database provides a useful snapshot of the chemistry of vapors associated with gasoline-contaminated sites. A summary of data used in the following evaluation of the database is provided in the supplement to this paper.

Figure 2 presents a summary of TPH-to-Benzene ratios for soil vapor samples included in the USEPA PVI database. As discussed earlier, only samples with reported concentrations of TPH greater than  $1,000 \mu\text{g}/\text{m}^3$  were considered in order to limit potential biases due to laboratory detection limits or interference from outdoor air [2]. A total of 364 samples met these criteria and included data for both TPH and benzene (see paper supplement). The inclusion of benzene in reported TPH concentrations is not known. The consistently high ratio of TPH to benzene in the samples negates a significant bias with respect to double counting of benzene in the TPH data. Non-specific, TPH hydrocarbon compounds clearly dominate petroleum vapors in the samples included in the USEPA database. The ratio of TPH to benzene ratio is consistently greater than 4:1, however, with a median ratio of 301:1, an average of 5,566:1 and a high of 4,000,000:1. The TPH:Benzenes ratio varies by an order of magnitude or more at most sites where multiple samples were collected and up to three orders of magnitude at some sites (see supplement). The potential causes of this variability are discussed below.

As depicted in Figure 2, the ratio of TPH to benzene exceeds the default, critical ratio of 900:1 (rounded from 935:1, see Table 8) developed earlier for gasoline vapors in 33% of the samples included in the database. This implies that the overwhelming proportion of aliphatic compounds in these samples would cause TPH, and not benzene, to drive potential vapor intrusion risks. In other words, if vapor intrusion were indeed a concern at these sites (e.g., subslab soil vapor screening levels exceeded and intrusion pathways present), then remediation of the site to reduce benzene in soil vapor down to target screening levels may not adequately address the noncancer risk posed by the TPH component of the vapors. Screening and/or remediation of the site to address TPH concerns would, however, concurrently address vapor intrusion concerns associated with benzene (*i.e.*, benzene would be below respective screening level at the point that TPH screening level was met).

Recall that this ratio assumes a target risk for benzene of  $10^{-6}$  and a correlatively conservative indoor air and subsequent soil vapor screening level (e.g., target indoor air goal of  $0.31 \mu\text{g}/\text{m}^3$  for residential scenarios; see Table 6). If a less conservative, target risk were used to calculate screening levels then the risk of missing potential vapor intrusion problems posed by TPH would be much higher. For example, the critical TPH:Benzenes ratio associated with a target risk of  $10^{-5}$  for the latter would be 90:1, adjusting the previous example downward by a factor of ten (*i.e.*,  $290 \mu\text{g}/\text{m}^3$  divided by

3.1  $\mu\text{g}/\text{m}^3$ ). In the case of the samples referenced from the USEPA database, the TPH:Benzene ratio exceeds this critical ratio 78% of the time (see Figure 2). This highlights the importance of quantitatively including TPH in vapor intrusion studies when a less conservative, target risk and associated screening levels are applied for individual compounds such as benzene. Note that this is not affected by attenuation factors assumed in the screening levels, since they are presumably identical for both benzene and TPH.

**Figure 2.** Summary of TPH to benzene ratios for soil vapor samples included in the USEPA PVI database (n = 364). Reflects gasoline-only sites with  $>1,000 \mu\text{g}/\text{m}^3$  TPH.

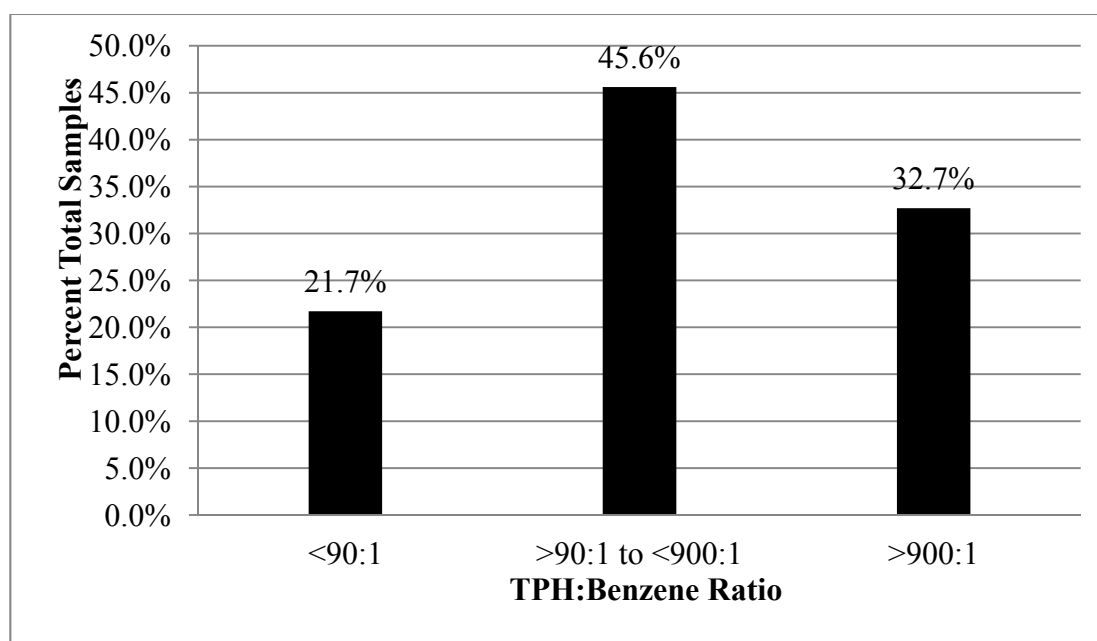

The relatively high proportion of TPH to benzene for a significant number of vapor samples from gasoline-only sites included in the USEPA database was initially surprising, given the traditional focus on only the BTEX fraction of these fuels [33]. As discussed earlier, seemingly low levels of benzene in the samples could be due to a number of factors, including: (1) Inadvertent inclusion of vapor data associated with middle distillate fuels in the database, (2) An original, minimal concentration of benzene in the gasoline released, (3) Preferential removal of benzene from soil vapors due to partitioning into soil moisture, and/or preferential biodegradation. Given the relatively high concentration of TPH reported in the samples (up to  $31,000,000 \mu\text{g}/\text{m}^3$ ), the dominance of C5-C8 aliphatics over C9-C12 aliphatics in seven of nine samples with carbon range data and a TPH:Benzene ratio  $>900:1$  (see supplement), and laboratory studies that suggest a much lower biodegradation rate for aromatics than aliphatics [34], the most likely cause for at least some of the samples appears to be an initially low concentrations of benzene in the gasoline released at the site. Likely variation in the degradation and removal of aliphatic and aromatic compounds between and even within sites complicates interpretation of the data. A more detailed study of this issue is beyond the scope of this paper.

As discussed earlier, several oil companies have moved toward low-benzene gasolines in recent years in order to lower the toxicity of auto exhaust as well as soil and groundwater contaminated by inadvertent releases of the fuels. Releases associated with some of these fuels appear to have been

captured in the USEPA database. This is an important observation, given a common assumption that benzene can be used as a stand-alone tool to evaluate the risk posed by releases of gasoline to the environment, including vapor intrusion (e.g., see [32]). This evaluation appears to have focused on traditionally targeted, individual compounds and did not specifically consider the relative role of TPH in vapor intrusion. Indeed, the TPH:Benzenes ratio exceeds the maximum critical ratio of 2,032:1 in 24% of the soil vapor samples from supposed gasoline-only sites (see supplement). This implies that TPH would drive vapor intrusion risk over benzene regardless of both the target risk applied to benzene (e.g.,  $10^{-6}$  excess cancer risk) and the carbon range composition of the TPH vapors (e.g., best case 100% C5-C8 aliphatics).

### 3.3. Vapors Associated with Diesel and Other Middle Distillate Fuels

The PVI database being compiled by the USEPA focuses on vapors associated with gasoline-contaminated soil and groundwater. As presented earlier, the Hawaii Department of Health (HDOH), through a grant from the USEPA, carried out a field study of the chemistry and toxicity of vapors associated soil and groundwater contaminated with diesel and other middle distillate fuels in an effort to supplement the USEPA database [10]. Particular emphasis was placed on the aliphatic and aromatic makeup of the TPH component of petroleum vapors and the potential for TPH to drive potential vapor intrusion risk over individual compounds such as benzene, toluene, ethylbenzene, xylenes and naphthalene.

Soil vapor data for petroleum-contaminated sites across Hawaii were reviewed as part of the study. Five sites with known, heavy contamination were targeted for detailed sampling. A limited number of samples were also collected over fresh fuels, although these data are not reviewed as part of this paper. Fuels released at sites included gasolines, including AVGAS and JP-4, JP-8 and diesel. Pipeline releases with widespread contamination and existing soil vapor monitoring points were targeted in order to ensure that vapors would be encountered and to minimize field sample collection costs. Sites A, B, C and E are believed to reflect a progressive domination by diesel and/or other middle distillate fuels such as JP-8 (similar to diesel). Site D is associated with a forty year-old release of JP-4 (mix of gasoline and kerosene) from a large fuel pipeline.

TPH compounds dominated petroleum vapors at each of the five, primary sites investigated during the study as well as other sites reviewed during the study, with less than 1% of the total vapors generally attributable to BTEXN (Table 9). The average ratio of TPH to benzene in soil vapors ranged from 1,500:1 at a site contaminated with JP-4 and AVGAS to over 18,000:1 at a site contaminated primarily by diesel fuel. The average TPH:Benzenes ratio exceeded 2,000:1 at the three sites where diesel and other middle distillate fuels were known to be present. As noted in Table 9, the maximum concentration of TPH in soil vapor samples collected at the sites were well above screening levels ultimately generated for potential vapor intrusion concerns.

The overwhelming proportion of TPH in the soil vapors at these sites ensure that TPH will dominate vapor intrusion risks over benzene and other individual VOCs regardless of the actual carbon range makeup and weighted toxicity of the TPH, even if a conservative, target risk were used for carcinogens. The average TPH:Benzenes ratio at an aged, JP-4/AVGAS release site included in the study (>9,000:1; Site A) exceeded the default, critical ratio for gasoline vapors of 900:1 noted earlier. The TPH:Benzenes

ratio for soil vapor samples collected at middle distillate sites was even higher. The near absence of benzene in soil vapors at the JP-4/AVGAS site could be associated with a preferential removal of vapor-phase, aromatic compounds over aliphatic compounds over time due, for example, to preferential diffusion into soil moisture. This could also be simply due to an absence of significant benzene in the original fuels released. Similar observations have been made at other gasoline-contaminated sites in Hawaii [10].

**Table 9.** Example TPH concentration in soil vapor, average TPH:Benzenes ratio and TPH carbon range makeup of soil vapor samples collected in the Hawaii DOH petroleum vapor study (based on summa canister, TO-15 data).

Site/Fuel Type	Example TPH ( $\mu\text{g}/\text{m}^3$ )	Average TPH:Benzenes Ratio	Average Carbon Range Composition		
			Aliphatics		Aromatics
			C5-8	C9-10	C9-12
Site A (JP-4/AVGAS)	300,000,000 $\mu\text{g}/\text{m}^3$	1,513:1	96%	0.2%	3.3%
Site B (mixed fuels)	220,000,000 $\mu\text{g}/\text{m}^3$	4,174:1	93%	0.3%	6.8%
Site C (JP-8 +/- JP-4)	86,000,000 $\mu\text{g}/\text{m}^3$	18,710:1	72%	0.6%	27%
Site D (JP-4/AVGAS)	2,600,000 $\mu\text{g}/\text{m}^3$	9,135:1	63%	4.1%	33%
Site E (diesel)	13,000,000 $\mu\text{g}/\text{m}^3$	54,236:1	25%	0.9%	74%

Aliphatic compounds dominate TPH vapors at all of the sites, although the relative proportion of C5-C8 versus C9-C12 compounds varied considerably (see Table 9). A comparison of co-located and concurrent Summa canister data to sorbent tube data identified only a minor contribution of C13+ aliphatic compounds for TPH vapors at the sites (<10%). The contribution of C9 and higher, aromatic TPH compounds in the samples was likewise negligible.

Weighted TPH Reference Concentrations and associated indoor air and soil as screening levels based on the carbon range makeup of the TPH follow a similar trend (Table 10). The weighted TPH RfC and associated action levels calculated for vapors associated with a relatively recent, gasoline-contaminated site (e.g., Site A and Site B) approach those for C5-C8 aliphatics (e.g., TPH RfC 400 to 600  $\mu\text{g}/\text{m}^3$ ). The weighted TPH RfC and associated action levels calculated for vapors collected from sites progressively dominated by diesel or other middle distillate fuels (Sites B, C and E) or associated with aged, JP-4 (Site D) approach those for the more toxic, C9-C12 aliphatic compounds (e.g., TPH RfC 100 to 200  $\mu\text{g}/\text{m}^3$ ) and are reflective of the higher proportion of these compounds in the vapors.

The lowest (i.e., most “toxic”), weighted Reference Concentration calculated was calculated for samples collected from an aged, diesel-contaminated site where TPH vapors were composed of an average 75% C9-12 aliphatics (Site E in Table 10). Free product on groundwater at the site was relatively shallow (<10 ft). Concentrations of TPH in soil vapor were perhaps an order of magnitude lower than would be anticipated at a site contaminated to a similar amount of gasoline. Even so, TPH in some samples exceeded 100,000,000  $\mu\text{g}/\text{m}^3$ , and were well above screening levels for potential vapor intrusion concerns.

Correction

## Correction: Brewer, R.; et al. Risk-Based Evaluation of Total Petroleum Hydrocarbons in Vapor Intrusion Studies. *Int. J. Environ. Res. Public Health* 2013, 10, 2441–2467

Roger Brewer <sup>1,\*</sup>, Josh Nagashima <sup>1</sup>, Michael Kelley <sup>2</sup>, Marvin Heskett <sup>3</sup> and Mark Rigby <sup>4</sup>

<sup>1</sup> Hawaii Department of Health, 919 Ala Moana Blvd Room 206, Honolulu, HI 96814, USA; E-Mail: josh.nagashima@doh.hawaii.gov

<sup>2</sup> EA Engineering, Science and Technology, 615 Piikoi St #515, Honolulu, HI 96814, USA; E-Mail: mkelley@eaest.com

<sup>3</sup> Geotek Hawaii, Inc., P.O. Box 1555, Pearl City, HI 96782, USA; E-Mail: mhesketts@mac.com

<sup>4</sup> Parsons Corporation, 10235 South Jordan Gateway, Suite 300, South Jordan, UT 8409, USA; E-Mail: mark.rigby@parsons.com

\* Author to whom correspondence should be addressed; E-Mail: roger.brewer@doh.hawaii.gov; Tel.: +1-808-586-4249; Fax: +1-808-586-7537.

Received: 7 July 2014 / Accepted: 9 July 2014 / Published: 14 July 2014

The authors wish to add the following amendments and corrections to their paper published in *IJERPH* [1].

Page 2460, Table 9: The data in last two columns are reversed. The correct Table 9 should be:

**Table 9.** Example TPH concentration in soil vapor, average TPH:Benzene ratio and TPH carbon range makeup of soil vapor samples collected in the Hawaii DOH petroleum vapor study (based on summa canister, TO-15 data).

Site/Fuel Type	Example TPH ( $\mu\text{g}/\text{m}^3$ )	Average TPH:Benzene Ratio	Average Carbon Range Composition		
			Aliphatics C5-8	C9-12	Aromatics C9-10
Site A (JP-4/AVGAS)	300,000,000 $\mu\text{g}/\text{m}^3$	1,513:1	96%	3.3%	0.2%
Site B (mixed fuels)	220,000,000 $\mu\text{g}/\text{m}^3$	4,174:1	93%	6.8%	0.3%
Site C (JP-8 +/- JP-4)	86,000,000 $\mu\text{g}/\text{m}^3$	18,710:1	72%	27%	0.6%
Site D (JP-4/AVGAS)	2,600,000 $\mu\text{g}/\text{m}^3$	9,135:1	63%	33%	4.1%
Site E (diesel)	13,000,000 $\mu\text{g}/\text{m}^3$	54,236:1	25%	74%	0.9%

**Table 10.** Weighted TPH Reference Concentration and example TPH subslab soil vapor screening levels for soil vapor samples collected in the Hawaii DOH petroleum vapor study.

Site/Fuel Type	Weighted RfC <sup>1</sup> ( $\mu\text{g}/\text{m}^3$ )	Indoor Air Screening Level <sup>2</sup> ( $\mu\text{g}/\text{m}^3$ )	Subslab Soil Vapor Screening Level <sup>3</sup> ( $\mu\text{g}/\text{m}^3$ )	TPH:Benzene Critical Ratio <sup>4</sup>	TPH:Benzene Measured Ratio	Vapor Intrusion Risk Driver <sup>5</sup>
Site A	510	530	530,000	1,710:1	1,513:1	Benzene
Site B	443	460	460,000	1,484:1	4,174:1	TPH
Site C	251	260	260,000	839:1	18,710:1	TPH
Site D	211	220	220,000	710:1	9,135:1	TPH
Site E	127	130	130,000	410	54,236:1	TPH

<sup>1</sup> Based on average carbon range composition (see Table 9); <sup>2</sup> Residential exposure scenario; see equation and assumptions in text; <sup>3</sup> Assuming an indoor air:subslab soil vapor attenuation factor of 0.001; <sup>4</sup> TPH indoor air screening level divided by benzene screening level (based on target cancer risk of  $10^{-6}$ ); Above this ratio, TPH in soil vapor could still pose a vapor intrusion risk even if benzene is at or below target screening levels.

<sup>5</sup> Based on comparison to average TPH: Benzene ratio for samples noted in previous table.

The TPH:Benzenes critical ratio for each set of study site samples is noted in Table 10. A comparison of these ratios to the measured, TPH:Benzenes ratio for samples collected at each site provides insight on the relative role of TPH in overall vapor intrusion risk. As indicated in Table 10, benzene drives potential vapor intrusion risk over TPH for soil vapor samples collected at Site A, a JP-4/AVGAS release (*i.e.*, measured TPH:Benzenes ratio in soil vapor below critical ratio). Dividing the measured TPH:Benzenes ratio by the risk-based, critical ratio for the same samples represents the theoretical, noncancer Hazard Quotient for TPH with respect to vapor intrusion at the point that the concentration of benzene in soil vapor equals the target, benzene screening level. In the case of Site A, a Hazard Quotient of 0.9 is calculated, suggesting that TPH will not pose a significant vapor intrusion risk if a target,  $10^{-6}$  risk is met for benzene. Note that use of a target risk of  $10^{-5}$  to screen for benzene would be associated with a theoretical, noncancer Hazard Quotient of approximately nine for TPH. This highlights the need to use a conservative, target cancer risk for benzene at sites with the measured, TPH:Benzenes ratio of more than approximately 100:1, as a rough guide.

It is interesting to note that screening and/or remediation of Site A with respect to TPH only and without consideration of benzene would at worst leave benzene in soil vapors only marginally above the target,  $10^{-6}$  risk goal. Reducing TPH in soil vapor to 530,000  $\mu\text{g}/\text{m}^3$  would in theory result in a concentration of benzene in soil vapor of approximately 350  $\mu\text{g}/\text{m}^3$ , only marginally above the screening level of 310  $\mu\text{g}/\text{m}^3$  and equating to a cancer risk of only  $1.1 \times 10^{-6}$ . Ignoring benzene and focusing only on TPH would be unlikely to leave potentially significant, vapor intrusion risks posed by the former unaddressed.

A comparison of the TPH to benzene field ratio to the calculated, risk-based, critical ratio at the remaining four sites included in the Hawaii study clearly identifies TPH as the vapor intrusion risk driver. For samples collected from Site B, the measured TPH:Benzenes ratio exceeds the risk-based, critical ratio for the same sample set by a factor of almost three (see Tables 9 and 10). In theory, this suggests that the noncancer, Hazard Quotient posed by TPH in soil vapor for vapor intrusion would



still approach three at the point that the concentration of benzene was reduced to a target,  $10^{-6}$  risk (*i.e.*, TPH in soil vapor would equal approximately  $1,300,000 \mu\text{g}/\text{m}^3$  at the point that benzene equals  $310 \mu\text{g}/\text{m}^3$ ). The TPH:Benzenes critical ratio is exceeded by an even larger degree for samples collected at the remaining three sites (*i.e.*, twenty-two, thirteen and one-hundred thirty two for Sites C, D and E, respectively). This suggests that TPH could still pose a significant vapor intrusion hazard at the sites well beyond the point that a target risk of  $10^{-6}$  for benzene was met. This is not surprising, given the relatively minor contribution of benzene to overall petroleum vapors at the sites. It is also worthwhile to note that naphthalene and methylnaphthalenes played a limited role in potential vapor intrusion risk at the middle distillate sites reviewed in the study, in spite of the assumed higher concentration of these chemicals in the original fuel released. The lack of significant naphthalenes in soil vapor samples is most likely due to the propensity of these chemicals to sorb to soil particles rather than partition into the vapor phase.

The Hawaii study highlights the potential for significant, vapor intrusion concerns posed by subsurface releases of middle distillate fuels, including diesel, as well as low-benzene gasolines. Reported concentrations of TPH in shallow soil vapor samples collected within or near source areas were well above risk-based screening levels for vapor intrusion concerns. The study also highlights the need to quantitatively consider TPH in vapor intrusion risk assessments at these sites when the ratio of TPH to benzene in soil vapor exceeds a value of approximately 450:1 if a target risk of  $10^{-6}$  is applied to benzene or a value of approximately 45:1 if a target risk of  $10^{-5}$  is applied (*e.g.*, TPH indoor air screening level of  $140 \mu\text{g}/\text{m}^3$  divided by benzene screening level of  $0.31 \mu\text{g}/\text{m}^3$  or  $3.1 \mu\text{g}/\text{m}^3$ ; see Tables 6 and 7).

#### 4. Summary and Conclusions

Vapors emitted from petroleum fuels are dominated by aliphatic and to a lesser degree aromatic compounds collectively measured as Total Petroleum Hydrocarbons or “TPH”. Published physiochemical constants and toxicity factors for volatile, TPH aliphatic and aromatic carbon ranges allows for quantitative, risk-based evaluation of TPH in vapor intrusion investigations in the same manner as carried out for traditionally targeted chemicals such as benzene, toluene, ethylbenzene, xylenes and naphthalene. Generic and/or site-specific TPH screening levels can be generated based on the assumed or known aliphatic and aromatic makeup of the petroleum vapors.

The relative role of TPH in vapor intrusion in comparison to individually targeted compounds such as benzene can be quickly determined by comparison of the ratio of TPH to the compound measured in the field to the ratio of risk-based screening levels for these chemicals. If, for example, the ratio of TPH to benzene in soil vapor measured in the field exceeds this “critical ratio” based on a comparison of screening levels then the concentration of TPH in indoor air (or soil vapor) would still exceed its risk-based screening level even though the concentration of benzene was at or below its respective screening level. If the critical ratio is not exceeded, then the concentration of TPH in indoor air (or soil vapor) would be at or below its respective screening level when the screening level for benzene is met. In the first case, reliance on benzene data alone to assess potential vapor intrusion risks would be inappropriate. In the latter case, a focus on benzene for final decision making purposes should ensure that potential vapor intrusion risks posed by TPH will also be addressed.

Critical ratios are necessarily dependent on the toxicity factors applied to individual, TPH carbon ranges. Based on TPH toxicity factors published by the USEPA [16] and a  $10^{-6}$  excess cancer risk for benzene, a TPH:Benzenes critical ratio of approximately 900:1 serves as a conservative tool for initial screening of gasoline-contaminated sites (*i.e.*, TPH could drive vapor intrusion risk when the concentration of TPH is more than 900 times that of benzene). This ratio is not exceeded for the majority (67%) of samples from gasoline-contaminated sites included a soil vapor database compiled by the USEPA [32]. This suggests that consideration of benzene in the absence of TPH data will be adequate to screen most gasoline-contaminated sites for potential vapor intrusion concerns if a conservative target cancer risk is applied to benzene.

Benzenes clearly drives vapor intrusion risk for only 22% of the samples in the USEPA database, however, if a less conservative target risk of  $10^{-5}$  is applied (*i.e.*, order-of-magnitude higher concentration of benzene considered acceptable). Furthermore, the measured ratio of TPH to benzene exceeded the screening value of 900:1 for 33% of the samples in the database, implying that TPH could drive vapor intrusion risk over benzene with respect to these samples depending on the target risk applied to the latter and the actual carbon range makeup of TPH. At least some of these sites appear to be associated with releases of gasoline that was originally low in benzene. In addition, the TPH:Benzenes ratio exceeds a hypothetical, toxicity-based, maximum critical ratio of 2,032:1 in 24% of the soil vapor samples in the USEPA database. This implies that TPH would drive vapor intrusion risk over benzene regardless of both the target risk applied to benzene *and* the carbon range composition of the TPH vapors.

Initial screening of gasoline-contaminated sites with respect to relative proportions of TPH and benzene present in soil vapors therefore appears to be prudent. Note that this may appear to conflict with the statement in the USEPA PVI database report that “available data indicate benzene is the risk driver for the (gasoline-release) sites evaluated” [32]. This conclusion however, was based on a comparison of the relative vapor intrusion risk posed by benzene to other, traditionally targeted, individual compounds such as toluene, ethylbenzene, xylenes and naphthalene. A detailed evaluation of the TPH component of the PVI database had not been carried out at the time that the USEPA report was published. This paper expands the database evaluation to include this comparison.

Vapors associated with subsurface releases of diesel and other middle distillate fuels can exhibit a higher proportion of more toxic, C9-C12 and higher aliphatic compounds, although the magnitude of vapors released from contaminated soil and groundwater will be lower than for an equivalent amount of gasoline. In this case a lesser amount of TPH in soil vapor (or indoor air) is required before the TPH fraction of the vapors begins to drive vapor intrusion risk over benzene or other individual compounds. Based on a limited study carried out by the State of Hawaii, a critical TPH to benzene ratio of approximately 450:1 served as a useful tool for initial screening of vapor data at sites contaminated with diesel or other middle distillate fuels. The measured ratio of TPH to benzene at all of the middle distillate sites reviewed in the Hawaii study reviewed in this paper exceeded this ratio by a wide margin, suggesting that TPH will play a dominant role in vapor intrusion at sites contaminated by these types of fuels. Significant levels of both C5-C8 aliphatics and C9-C12 aliphatics at the sites investigated highlight the need to report TPH as the sum of C5-C12 compounds for soil vapor samples collected at middle distillate-release sites, even though this is traditionally referred to as “gasoline range” hydrocarbons by commercial laboratories.

Carbon range data for TPH in soil vapor can be used to develop site-specific vapor intrusion screening levels for TPH or for direct calculation of potential vapor intrusion risk. A review of case studies highlights the importance of including a review of TPH in vapor intrusion investigations. This can be done at an initial screening level by simple comparison of the measured ratio of TPH to benzene and other targeted compounds to the ratio of generic or site-specific, risk-based screening levels for these compounds. The gradual reduction of benzene in gasolines over time and high concentrations of aliphatic compounds in vapors associated with diesel releases highlights the need to consider TPH in vapor intrusion studies.

Identification of TPH or individual compounds in soil vapor above target screening levels and/or critical ratios does not necessarily imply that a vapor intrusion problem indeed exists. It is worthwhile to note that odor thresholds for petroleum fuels are within an order of magnitude of the risk-based screening levels for TPH presented in this paper. Given the hundreds of thousands of petroleum releases identified in the US over the past twenty years, the fact that few instances of petroleum-related vapor intrusion have been reported suggests in itself that significant risks are most likely limited to the presence of heavy contamination in soil or groundwater within close proximity to a building floor.

As discussed in numerous studies, this suggests that significant attenuation forces beyond those typically assumed for chlorinated solvents are in play both beneath and most likely within the subject buildings. Natural biodegradation of vapor-phase, petroleum compounds in contaminated soil and groundwater will significantly reduce the long-term vapor-intrusion risk of subsurface contamination in comparison to soil contaminated with an equal amount of chlorinated solvents. Regional climate, geology and associated building ventilation designs strongly influence local indoor air: subslab attenuation factors. The relative persistence of petroleum compounds in indoor air with respect to vapor flux rates should also be considered.

### **Acknowledgements**

The soil vapor study carried out by the Hawaii Department of Health was carried out under a grant from the United States Environmental Protection Agency.

### **Disclaimer**

This document has been funded partly or wholly through the use of U.S. EPA State Response Program Grant funds. Its contents do not necessarily reflect the policies, actions or positions of the U.S. Environmental Protection Agency. The Hawai'i Department of Health does not speak for nor represent the U.S. Environmental Protection Agency.

### **Conflict of Interest**

The authors declare no conflict of interest.

## References

1. Potter, T.L.; Simmons, K.E. Total Petroleum Hydrocarbon Working Group Series. In *Composition of Petroleum Mixtures*; Association for Environmental Health and Sciences: Amherst, MA, USA, 1998; Volume 2.
2. *Characterizing Risks Posed by Petroleum Contaminated Sites (Policy No. WSC-02-41-1)*; Massachusetts Department of Environmental Protection: Boston, MA, USA, 2002.
3. *Risk-Based Decision Making for the Remediation of Petroleum-Contaminated Sites*; Oregon Department of Environmental Quality, Environmental Cleanup and Tanks Program: Portland, OR, USA, 2003.
4. *Screening for Environmental Concerns at Sites with Contaminated Soil and Groundwater*; California Environmental Protection Agency, Regional Water Quality Control Board, San Francisco Bay Area Region: Oakland, CA, USA, 2005.
5. *Cleanup Levels and Risk Calculations Focus Sheets: Reference Doses for Petroleum Mixtures*; Washington Department of Ecology: Lacey, WA, USA, 2006.
6. *Cleanup Levels Guidance*; Alaska Department of Environmental Conservation, Division of Spill Prevention and Response: Juneau, AK, USA, 2008.
7. *Guidelines for Utah's Corrective Action Process for Leaking Underground Storage Tank Sites*; Utah Department of Environmental Quality, Division of Environmental Response and Remediation: Salt Lake City, UT, USA, 2010.
8. *Evaluation of Environmental Hazards at Sites with Contaminated Soil and Groundwater*; Hawaii Department of Health, Office of Hazard Evaluation and Emergency Response: Honolulu, HI, USA, 2011.
9. *Guidelines for TPH Fractionation at Leaking Underground Storage Tank Sites*; Utah Department of Environmental Quality, Division of Environmental Response and Remediation: Salt Lake City, UT, USA, 2012.
10. *Field Investigation of the Chemistry and Toxicity of TPH in Petroleum Vapors: Implications for Potential Vapor Intrusion Hazards*; Hawaii Department of Health, Office of Hazard Evaluation and Emergency Response: Honolulu, HI, USA, 2012.
11. Kelly, M.J.; Brewer, R.; Rigby, M. Use of TPH Carbon Range Data to Guide Remediation of Petroleum Contamination for Vapor Intrusion. Remediation of Chlorinated and Recalcitrant Compounds. In Proceedings of the Eighth International Battelle Conference, Monterey, CA, USA, 21–24 May 2012.
12. *Long-Term Management of Petroleum-Contaminated Soil and Groundwater*; Hawaii Department of Health, Office of Hazard Evaluation and Emergency Response: Honolulu, HI, USA, 2007.
13. Kaplan, I.R.; Galperin, Y.; Lu, S.T.; Lee, R.U. Forensic environmental geochemistry: Differentiation of fuel types, their sources and release times. *Org. Geochem.* **2007**, *27*, 289–317.
14. *Chevron and Texaco Premium Unleaded Gasolines*; Chevron: San Ramon, CA, USA, 2011; MSDS No. 2653.
15. *Transport and Fate of Non-BTEX Petroleum Chemicals in Soils and Groundwater*; American Petroleum Institute, Health and Environmental Sciences Department: Washington, DC, USA, 1994; Publication No. 4593.

16. *Provisional Peer-Reviewed Toxicity Values for Complex Mixtures of Aliphatic and Aromatic Hydrocarbons*; U.S. Environmental Protection Agency, Superfund Health Risk Technical Support Center, National Center for Environmental Assessment, Office of Research and Development: Washington, DC, USA, 2009.
17. U.S. Environmental Protection Agency. Control of hazardous air pollutants from mobile sources. *Fed. Regist.* **2007**, *72*, 8428–8570.
18. *Gasoline Composition Regulations Affecting LUST Sites*; U.S. Environmental Protection Agency, Office of Research and Development: Washington, DC, USA, 2010.
19. *Updated Petroleum Hydrocarbon Fraction Toxicity Values for the VPH/EPH/EPH Methodology*; Massachusetts Department of Environmental Protection, Bureau of Waste Site Cleanup: Boston, MA, USA, 2003.
20. Gustafson, J.; Tell, J.G.; Orem, D. Selection of Representative TPH Fractions Based on Fate and Transport Considerations. In *Total Petroleum Hydrocarbon Working Group Series*; Association for Environmental Health and Sciences: Amherst, MA, USA, 1997; Volume 3.
21. *Risk Integrated System of Closure, Technical Resource Guidance Document*; Indiana Department of Environmental Management: Indianapolis, IN, USA, 2010.
22. *Screening Levels for Chemical Contaminants at Superfund Sites (Soil, Air, Tapwater.)*; U.S. Environmental Protection Agency: Washington, DC, USA, 2012.
23. *Supplemental Guidance for Developing Soil Screening Levels for Superfund Sites*; U.S. Environmental Protection Agency, Solid Waste and Emergency Response: Washington, DC, USA, 2002; OSWER 9355.4–24.
24. Hartman, B. The great escape—From the UST. *LUSTLine* **1998**, *30*, 18–20.
25. *BIOVAPOR—A 1-D Vapor Intrusion Model with Oxygen-Limited Biodegradation (Version 2.0)*; American Petroleum Institute: Washington, DC, USA, 2010.
26. Hayes, H.C.; Benton, D.J.; Grewal, S.; Khan, N. Evaluation of Sorbent Methodology for Petroleum-Impacted Site Investigation. In Proceedings of the Air and Waste Management Association, Providence, RI, USA, 26–27 September, 2007.
27. *Hazardous Substances Database*; U.S. National Library of Medicine (Toxnet): Bethesda, MD, USA, 2012.
28. Tveit, A.; Hayes, L.A.; Youngren, S.H.; Nakles, D.V. Development of Fraction Specific Reference Doses (RfDs) and Reference Concentrations (RfCs) for Total Petroleum Hydrocarbons. In *Total Petroleum Hydrocarbon Working Group Series*; Association for Environmental Health and Sciences: Amherst, MA, USA, 1997; Volume 4.
29. *Toxicological Profile for Total Petroleum Hydrocarbons*; U.S. Department of Health and Human Services, Agency for Toxic Substances and Disease Registry: Atlanta, GA, USA, 1999.
30. *Evaluating Human Health Risks from Total Petroleum Hydrocarbons*; California Department of Toxic Substances Control, Human and Ecological Risk Division: Sacramento, CA, USA, 2009.
31. DeVaul, G.E. Indoor vapor intrusion with oxygen-limited biodegradation for a subsurface gasoline source. *Environ. Sci. Tech.* **2007**, *41*, 3241–3248.
32. *Evaluation of Empirical Data to Support. Soil Vapor Intrusion Screening Criteria for Petroleum Hydrocarbon Compounds (EPA 510-R-13-001)*; U.S. Environmental Protection Agency, Office of Underground Storage Tanks: Washington, DC, USA, 2013.

33. *Standard Guide for Risk-Based Corrective Action Applied at Petroleum Release Sites*; American Society for Testing and Materials: West Conshohocken, PA, USA, 2010.
34. *Petroleum Hydrocarbons and Chlorinated Hydrocarbons Differ in their Potential for Vapor Intrusion*; U.S. Environmental Protection Agency, Office of Underground Storage Tanks: Washington, DC, USA, 2012.

© 2013 by the authors; licensee MDPI, Basel, Switzerland. This article is an open access article distributed under the terms and conditions of the Creative Commons Attribution license (<http://creativecommons.org/licenses/by/3.0/>).

## **2002 Massachusetts VPH-EPH Guidance**



COMMONWEALTH OF MASSACHUSETTS  
 EXECUTIVE OFFICE OF ENVIRONMENTAL AFFAIRS  
**DEPARTMENT OF ENVIRONMENTAL PROTECTION**  
 ONE WINTER STREET, BOSTON, MA 02108 617-292-5500

JANE M. SWIFT  
 Governor

BOB DURAND  
 Secretary

LAUREN A. LISS  
 Commissioner

**Characterizing Risks Posed by Petroleum Contaminated Sites:**  
*Implementation of the MADEP VPH/EPH Approach*

**FINAL POLICY**

**October 31, 2002**

**Policy #WSC-02-411**

This Policy provides guidance for parties conducting response actions under the Massachusetts Contingency Plan (MCP) on the use and application of the Volatile Petroleum Hydrocarbons (VPH) and Extractable Petroleum Hydrocarbons (EPH) methods to characterize risks posed by releases of petroleum products to the environment. This Policy updates and replaces draft documents that were issued on October 31, 1997 and June 2001. Parties who are currently using criteria and guidance contained in the June 2001 draft document may do so until May 1, 2003. A summary of significant changes between these earlier drafts and this Final Policy is provided in Appendix 6.

*The information contained in this document is intended solely as guidance. This Policy does not create any substantive or procedural rights, and is not enforceable by any party in any administrative proceeding with the Commonwealth. This Policy provides recommendations and guidance on approaches the Department considers acceptable for meeting the performance standards set forth in the MCP and discussed in this document. These performance standards include, but are not limited to, the Response Action Performance Standards of section 310 CMR 40.0191 of the MCP. Parties using this guidance should be aware that there may be other acceptable alternatives for achieving and documenting compliance with the general regulatory requirements and performance standards of the MCP, including those of 310 CMR 40.0191. The regulatory citations in this document should not be relied upon as a complete list of the applicable regulatory requirements.*

This Policy and further information on the development and application of the aliphatic/aromatic hydrocarbon evaluative technique employed by the Department, referred to as the "VPH/EPH" approach, may be obtained at [http://www.state.ma.us/dep/bwsc/vph\\_eph.htm](http://www.state.ma.us/dep/bwsc/vph_eph.htm)

10/31/02

*Signature on Original*

Date

Deirdre C. Menoyo  
 Assistant Commissioner  
 Bureau of Waste Site Cleanup



## Table of Contents

1.0	INTRODUCTION .....	1
1.1	Background .....	1
1.2	Purpose and Scope .....	1
1.3	Applicability .....	2
1.3.1	Site Closure on or after October 31, 1997 .....	2
1.3.2	Site Closure Prior to October 31, 1997 .....	2
2.0	SUMMARY OF THE VPH/EPH APPROACH .....	2
2.1	The Concept .....	2
2.2	Hydrocarbon Fractions of Interest .....	3
2.3	Relationship of VPH/EPH to TPH and Gasoline Range Organics (GRO) .....	4
2.4	Additional Research and Data Needs .....	5
3.0	ANALYTICAL METHODS .....	5
3.1	Gas Chromatography .....	5
3.2	MADEP Analytical Methodologies .....	6
3.2.1	Volatile Petroleum Hydrocarbons (VPH) .....	7
3.2.2	Extractable Petroleum Hydrocarbons (EPH) .....	8
3.2.3	Air-Phase Petroleum Hydrocarbons (APH) .....	8
3.3	VPH/EPH Target Analytes .....	9
3.4	Sampling Procedures and Requirements for the VPH/EPH Methods .....	9
3.5	Modifications of the VPH/EPH Methods .....	10
3.6	Data Quality and Report Content .....	11
3.7	Other Hydrocarbon Testing Methods .....	13
3.7.1	Total Petroleum Hydrocarbons .....	13
3.7.2	Environmental Forensic Techniques .....	14
3.8	Analytical Screening Techniques .....	15
3.8.1	Principles of Operation, Biases, and Calibration .....	17
3.8.2	Recommended Approach .....	17
3.9	Drinking Water Testing Methods .....	18
4.0	CLEANUP STANDARDS .....	18
4.1	Exposure Point Concentrations .....	19
4.1.1	Groundwater EPCs .....	19
4.1.2	Soil EPCs .....	20
4.1.3	Indoor Air EPCs .....	20
4.2	Method 1 Cleanup Standards .....	20
4.2.1	Using Method 1 VPH/EPH Fractional Standards .....	21
4.2.2	Target Analytes .....	22
4.2.2.1	Petroleum Product Additives.....	22
4.2.2.2	Petroleum Product Additives as Target Analytes .....	23
4.2.2.3	Ethanol .....	23
4.2.2.4	Additional Petroleum Additives .....	24
4.2.3	Hydrocarbon Fractions of Interest .....	25
4.2.4	Limitations on the Use of Method 1 Cleanup Standards .....	26
4.2.4.1	Hydrocarbons .....	26
4.2.4.2	Additives .....	26
4.2.4.3	Air-Phase Contamination .....	26
4.2.5	Odors .....	26
4.3	Method 2 Risk Characterization .....	27
4.3.1	Using a Method 2 Approach to Demonstrate “No Impact” to Indoor Air .....	28
4.3.1.1	Level 1 - Soil Gas Screening .....	29
4.3.1.2	Level 2 - Soil Gas Analysis .....	30

## Table of Contents (continued)

	4.3.1.3 Level 3 - Indoor Air Analysis .....	32
	4.3.1.4 Use of Vapor Transport Models .....	33
	4.3.1.5 Vertical Profiling of Groundwater Contaminants to Evaluate Vapor Transport ..	34
	4.3.1.6 Response Actions at Sites with Indoor Air Impacts .....	34
	4.3.2 Using a Method 2 Approach to Evaluate Exceedences of GW -3 Method 1 Standards .....	34
	4.3.3 Using a Method 2 Approach to Evaluate Leaching .....	37
4.4	Method 3 Risk Characterization .....	38
	4.4.1 Requirements and Limitations of a Method 3 Characterization .....	38
	4.4.2 Impacts to Indoor Air .....	39
	4.4.3 Odors as a Significant Risk to Public Welfare .....	39
	4.4.4 MADEP Petroleum-Contaminated Site Risk Assessment Short Forms .....	40
4.5	Recommended Toxicological Parameters .....	40
4.6	Recommended Fate and Transport Parameters .....	40
4.7	Non-Aqueous Phase Liquids (NAPL) .....	41
	4.7.1 Upper Concentration Limits .....	41
	4.7.2 Apparent NAPL Thickness vs. Actual NAPL Thickness .....	41
	4.7.3 NAPL and Vapor/Indoor Air Impacts .....	42
4.8	Elimination of Continuing Sources .....	42
4.9	Feasibility of Achieving Background Concentrations .....	43
5.0	IMPLEMENTATION ISSUES .....	44
5.1	Site Characterization .....	44
	5.1.1 Analytical Parameters .....	44
	5.1.2 Site and Media Characterization .....	44
	5.1.3 Filtering of Groundwater Samples .....	45
5.2	Use of Old and New TPH Data .....	46
	5.2.1 Comparing TPH Data to Reportable Concentrations/Method 1 Cleanup Standards/UCLs	46
	5.2.2 Converting TPH Data into EPH Fractional Ranges .....	47
5.3	VPH/EPH Compositional Variability/Recommended Approach .....	48
5.4	Other Program Issues .....	48
	5.4.1 Numerical Ranking System (NRS) .....	48
	5.4.2 Characterization of Remediation Wastes .....	49
	5.4.3 Characterization of Remedial Air Emissions .....	49
	5.4.4 Characterization of Coal Tar Contaminated Sites .....	49

## List of Tables

2-1: Toxicological Approach for Non-Cancer Health Effects .....	3
2-2: Hydrocarbon Fractions of Interest .....	4
3-1: Sample Collection, Preservation, and Holding Times .....	10
3-2: Recommended Analytical Approaches .....	13
3-3: Common/Available TPH Testing Methods .....	14
3-4: VPH/EPH Analytical Screening Techniques .....	16
3-5: Recommended Minimum VPH/EPH Laboratory Confirmation Data Needed to Support Analytical Screening .....	18
4-1: Choosing an MCP Risk Assessment/Cleanup Method .....	19
4-2: Minimum Recommended Quarterly Rounds of Groundwater Monitoring at sites where NAPL is Not Present .....	20
4-3: Recommended Target Analyte List for Petroleum Products .....	22
4-4: Common Gasoline Additives (Massachusetts) .....	23
4-5: Recommended Target Analyte List for Petroleum Additives .....	24
4-6: Hydrocarbon Fractions of Interest .....	25
4-7: Method 1 Standards Most Likely to be Exceeded .....	27
4-8: Use of Method 2 at Petroleum Contaminated Sites .....	27
4-9: Soil Gas PID/FID Screening Levels for Evaluating Indoor Air Impacts .....	29

## List of Tables (continued)

4-10: Soil Gas GC Screening Levels for Evaluating Indoor Air Impacts.....	32
4-11: Estimated Background Indoor Air Concentrations (Residential).....	33
4-12: Surface Water Quality Guidelines ..	35
4-13: Recommended VPH/EPH Toxicological & Risk Assessment Parameters .....	40
4-14: Recommended VPH/EPH Fractional Properties for Modeling Purposes.....	41
5-1: Recommended TPH Compositional Assumptions in Soil .....	47
5-2 Mobility and Persistence Scoring Criteria for VPH/EPH Fractions .....	48

## List of Figures

2-1: Relationship of VPH/EPH to TPH and Gasoline Range Organics (GRO).....	4
2-2: Overlap of VPH and EPH Test Methods .....	5
3-1: Sample Chromatogram - #2 Fuel Oil .....	6
4-1: Evaluating Indoor Air Pathway via Method 2 .....	28
4-2: GC/FID Soil Gas Chromatogram .....	31
4-3 Recommended Hierarchy of Vapor Mitigation Efforts .....	35
4-4: Groundwater Dilution Factors for Dissolved Hydrocarbons .....	36
4-5: Leaching Scenario Used to Develop Leaching-Based Method 1 Soil Standards .....	37

## List of Appendices

Appendix 1: Collecting and Preserving VPH Samples .....	50
Appendix 2: Shipping Methanol Preserved Samples .....	53
Appendix 3: Recommended Data Reporting Formats .....	54
Appendix 4: VPH/EPH Cleanup Standards and Reportable Concentrations .....	59
Appendix 5: Additional Reference/Support Materials .....	60
Appendix 6: Summary of Significant Changes to Final Implementation Policy .....	62

## LIST OF ACRONYMS

AAS	Atomic Absorption Spectroscopy
APH	Air-Phase Petroleum Hydrocarbons
AQWC	Ambient Water Quality Criteria
BTEX	Benzene, Toluene, Ethylbenzene, and Xylenes
CEP	Critical Exposure Pathway
EDB	Ethylene Dibromide
EPA	Environmental Protection Agency
EPC	Exposure Point Concentration
EPH	Extractable Petroleum Hydrocarbons
eV	Electron Volt
FID	Flame Ionization Detector
GC	Gas Chromatography or Gas Chromatograph
GC/FID	Gas Chromatograph/Flame Ionization Detector
GC/MS	Gas Chromatograph/Mass Spectrometer
GRO	Gasoline Range Organics
GW	Groundwater
HVAC	Heating, Ventilation, Air-conditioning
ICP-AES	Inductively coupled plasma atomic emissions spectroscopy
IR	Infra-red
LNAPL	Light Non-Aqueous Phase Liquids
LSP	Licensed Site Professional
MADEP	Massachusetts Department of Environmental Protection
MCP	Massachusetts Contingency Plan
MtBE	Methyl tertiary butylether
NAPL	Non-Aqueous Phase Liquids
NRS	Numerical Ranking System
OTP	Ortho-terphenyl
PAH	Polycyclic Aromatic Hydrocarbon
PCB	Polychlorinated Biphenyl
PID	Photoionization Detector
ppbV	Parts-per-billion by volume
ppmV	Parts-per-million by volume
QA/QC	Quality Assurance/Quality Control
RAF	Relative Absorption Factor
RAO	Response Action Outcome
RfC	Reference Concentration
RfD	Reference Dose
RL	Reporting Limit
SIM	Selective Ion Monitoring
SW	Surface Water
TIC	Tentatively Identified Compound
TOV	Total Organic Vapor
TPH	Total Petroleum Hydrocarbons
TPHCWG	Total Petroleum Hydrocarbon Criteria Working Group
UCL	Upper Concentration Limit
UCM	Unresolved Complex Mixture
UST	Underground Storage Tank
UV	Ultra-violet
VOC	Volatile Organic Compound
VPH	Volatile Petroleum Hydrocarbons
WSC	Waste Site Cleanup

# 1.0 INTRODUCTION

## 1.1 Background

Spills and releases of petroleum fuels are the leading source of environmental contamination in Massachusetts. Because petroleum products are a complex and highly variable mixture of hundreds of individual hydrocarbon compounds, however, characterizing the risks posed by petroleum-contaminated soil and water has proven to be difficult and inexact.

Traditional approaches have focused on the identification and evaluation of specific indicator compounds, like benzene, and/or the quantitation of a “Total Petroleum Hydrocarbon” (TPH) value. The limitations of an “indicator only” approach have long been recognized, especially at gasoline-contaminated sites, and it is clear that focusing on a select few compounds cannot adequately characterize the risks posed by all hydrocarbons present. While the quantitation of a TPH value is a step in the right direction, in that an attempt is being made to account for all compounds present, traditional TPH methods and approaches provide little or no information on the composition or toxicity of generated data.

In response to these shortcomings, the Massachusetts Department of Environmental Protection (MADEP) published a document in August 1994 entitled *Interim Final Petroleum Report: Development of Health-Based Alternative to the Total Petroleum Hydrocarbon (TPH) Parameter*. This document presented a new toxicological approach to characterize and evaluate risks posed by petroleum-contaminated sites, by breaking down TPH into collective aliphatic and aromatic fractions.

To support and implement this new toxicological approach, MADEP developed two analytical methods that differentiate and quantitate collective concentrations of aliphatic and aromatic hydrocarbons in soil and water. These methods, for *Volatile Petroleum Hydrocarbons* (VPH) and *Extractable Petroleum Hydrocarbons* (EPH), were issued in draft form in August 1995, and as final procedures in January 1998. At present, MADEP is in the process of finalizing a method for *Air-Phase Petroleum Hydrocarbons* (APH), which will allow for the collective quantitation of aliphatic and aromatic hydrocarbons in air. A draft APH method was issued by the agency in February 2000.

MADEP has integrated this new approach into the Massachusetts Contingency Plan (MCP), by developing and promulgating soil and groundwater cleanup standards for the aliphatic and aromatic ranges of interest. These standards became effective on October 31, 1997. Parties undertaking cleanup actions at petroleum-contaminated sites in Massachusetts now have the means to quickly and easily address risks posed by these complex mixtures, by the optional use of the generic *Method 1* cleanup standards. Conversely, such parties may elect to develop site-specific cleanup standards via use of a *Method 2* or *Method 3* risk assessment process.

## 1.2 Purpose and Scope

The purpose of this document is to (1) provide a succinct summary of key provisions of the “VPH/EPH” approach, (2) provide greater detail and specificity on important elements of this new approach, and (3) provide technical and regulatory insight, guidance, and **Rules of Thumb** to assist Licensed Site Professionals and others in understanding and applying this approach in a practical and cost-effective manner.

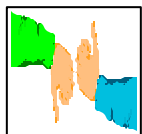

**Rules of Thumb** are suggestions and recommendations on how to approach, evaluate, and resolve investigatory, assessment, and remedial issues. In most cases, they are based upon reasonably conservative or “worst case” assumptions and considerations, and are intended to assist competent professionals in “ruling out” items of concern, or affirming a need to proceed to a more comprehensive level of evaluation. These rules are based upon current information, and are designed to be protective at most, but not all sites.

Derivation details are provided in “Background/Support Documentation for the Development of Publication Guidelines and Rules of Thumb”, available at: [http://www.state.ma.us/dep/bwsc/vph\\_eph.htm](http://www.state.ma.us/dep/bwsc/vph_eph.htm).

**Rules of Thumb may only be applied to the specific situations described in this document, as such guidelines are predicated upon a designated scenario and are reflective of the totality of conservative assumptions incorporated into that scenario. Changing any developmental element of these guidelines and/or applying them to situations not detailed in this document may not be sufficiently protective. Moreover, the use of these rules may not be appropriate at sites with complex or highly heterogeneous contaminant conditions or migration pathways, or at sites or portions of sites with highly sensitive receptors (e.g., drinking water wells).**

*While striving to be as useful and complete as possible, nothing in this document should be viewed as limiting or obviating the need for the exercise of good professional judgment.*

## 1.3 Applicability

The provisions of this document are applicable at sites contaminated by releases of one or more petroleum fuels and/or lubricating oils. The guidance contained in this policy is designed to help Licensed Site Professionals (LSPs) and others comply with the risk-based/performance-based requirements of the MCP to adequately investigate and assess releases of oil and waste oil to the environment.

The MCP – since 1988 – has required that parties conducting response actions at disposal sites document or achieve a level of no significant risk of harm to human health, safety, public welfare, and the environment. Because the MCP is performance-based, it does not dictate the specific means by which one demonstrates compliance with these standards. From a practical point of view, however, most parties did not have ready access to the tools and procedures needed to adequately characterize the total risks posed by petroleum contamination – until promulgation of the VPH/EPH approach, analytical methodologies, and Method 1 cleanup standards in 1997. For this reason, MADEP has adopted a prospective and retrospective position on the application of the VPH/EPH approach:

### *1.3.1 Site Closure on or after October 31, 1997*

Since October 31, 1997, MADEP has provided parties conducting response actions a means to easily and adequately assess risks posed by petroleum contaminants. Therefore, all sites closed on or after this date (e.g., by filing of a Response Action Outcome Statement) must demonstrate compliance with this standard, by use of the VPH/EPH approach, or by use of another scientifically valid and health-protective approach. In these cases, the use of an “indicator only” approach is NOT acceptable.

There are no “grand fathering” provisions for sites that were not closed out prior to October 31, 1997. However, this document provides guidance on how one might utilize and/or “convert” old data obtained prior to this date, to more fully assess risks pursuant to the VPH/EPH approach, and support a post-1997 closure submittal.

Notwithstanding the implementation of this new approach, it should be noted that the MCP retains a cleanup standard for Total Petroleum Hydrocarbons (TPH), which is set conservatively at the lowest EPH fractional cleanup standard (typically C<sub>1</sub>-C<sub>22</sub> Aromatic Hydrocarbons). Parties may continue to use a TPH approach to characterize heavier petroleum products (i.e., >C<sub>9</sub>), using the EPH method (in the TPH screening mode) or other scientifically valid and defensible method (See Section 3.7.1).

### *1.3.2 Site Closure Prior to October 31, 1997*

In general, MADEP will not require reevaluation of petroleum-contaminated sites properly closed prior to October 31, 1997. Nonetheless, the agency reserves the right to do so, in cases where direct and compelling exposure concerns are believed to be present, and where human health is being directly threatened. Such concerns may exist at sites where (1) a release of gasoline has impacted a drinking water well, or (2) a release of gasoline has resulted in persistent, long-term odors or vapors within an occupied structure.

In cases where parties voluntarily conduct VPH/EPH testing at sites closed prior to October 31, 1997 (e.g., pursuant to a property transfer evaluation), the applicable “re-opener” language is contained at 310 CMR 40.0317(17). Under the provisions of this section of the MCP, a notification obligation would exist for this newly obtained VPH/EPH data if such information would change or negate the findings of the closure document (e.g., RAO, LSP Evaluation Opinion).

## 2.0 SUMMARY OF VPH/EPH APPROACH

### 2.1 The Concept

Petroleum is a mixture of hundreds of hydrocarbon compounds. Industry specifications for refined products, such as gasoline and diesel fuel, are based upon physical and performance-based criteria, not upon a specific chemical formulation. As such, the composition of petroleum products released to the environment are complex and variable, and are a function of (1) the origin and chemistry of the parent crude oil, (2) refining and blending processes, and (3) the use of performance-enhancing additives. Once released to the environment, the chemistry of a petroleum product is further altered by contaminant fate and transport processes, such as leaching, volatilization, and biodegradation.

It would be extremely difficult and expensive to identify and quantitate every single hydrocarbon compound present in petroleum-contaminated media. Even if this activity was accomplished, there is little toxicological data available for the vast majority of petroleum constituents. While there are limited data available on the toxicity of some petroleum fuels, the chemistry of weathered products typically encountered at contaminated sites may be quite different from the chemistry of the fresh product that was the subject of toxicological evaluation.

Based upon an evaluation of information and data available on the chemistry and toxicity of petroleum products, however, it is possible to make some broad observations and conclusions:

- ◇ petroleum products are comprised mainly of aliphatic/alicyclic and aromatic hydrocarbon compounds;
- ◇ aromatic hydrocarbons appear to be more toxic than aliphatic compounds; and
- ◇ the toxicity of aliphatic compounds appears to be related to their carbon number/molecular weights.

These three precepts are the foundation of the VPH/EPH approach. Specifically, under this approach, the **non-cancer** toxicity of petroleum-contaminated media is established by (1) determining the collective concentrations of specified ranges of aliphatic and aromatic hydrocarbons, and (2) assigning a toxicity value (e.g., Reference Dose) to each range. Toxicity values are determined on the basis of a review and/or extrapolation of available toxicological data on hydrocarbon mixtures and specific hydrocarbon compounds. The complete breakdown for all ranges of interest is summarized in Table 2-1.

**Table 2-1: Toxicological Approach for Non-Cancer Health Effects**

Hydrocarbon Fraction	Reference Dose (mg/kg/day)
C5-C8 Aliphatic Hydrocarbons	0.04 <sup>a</sup>
C9-C18 Aliphatic Hydrocarbons	0.1 <sup>a</sup>
C19-C36 Aliphatic Hydrocarbons	2.0 <sup>a</sup>
C9-C22 Aromatic Hydrocarbons	0.03

<sup>a</sup> updated values (2002)

**Cancer effects** are evaluated separately, by the identification and quantitation of those specific hydrocarbon compounds, like benzene and certain polycyclic aromatic hydrocarbons (PAHs), which are designated carcinogens. Additional information and details on this approach are provided in the MADEP publication *Interim Final Petroleum Report: Development of Health-Based Alternative to the Total Petroleum Hydrocarbon (TPH) Parameter*, August, 1994, and as amended, available at [http://www.state.ma.us/dep/bwsc/vph\\_eph.htm](http://www.state.ma.us/dep/bwsc/vph_eph.htm)

## 2.2 Hydrocarbon Fractions of Interest

Although the non-cancer toxicity of petroleum-contaminated media can be adequately described by division into the four hydrocarbon fractions listed above, MADEP has chosen to designate six hydrocarbon fractions of interest, because of the following analytical and program considerations:

- ◇ EPA analytical methods have traditionally used one approach for the analysis of volatile organics (i.e., purge and trap), and another for the analysis of semi-volatile/extractable organics (i.e., solvent extraction). To facilitate use by commercial laboratories accustomed to such division, the VPH and EPH methods developed by MADEP maintain this distinction. Moreover, because of the large carbon range covered by the new approach (i.e., C5 to C36), it would be difficult to detect all fractions using just one method: the volatile/purgeable methods can adequately cover the lighter hydrocarbons, but not the heavier fractions (>C12), while, due to losses of low molecular weight hydrocarbons that occur during the sample preparation process, extractable methods are generally unable to reliably detect lighter fractions (<C9).
- ◇ Given the need for two analytical methods, and a desire to minimize use of both methods on all samples, a decision was made to break up the C9-C18 Aliphatic range, to enable detection of all gasoline-range hydrocarbons in the VPH method. In this manner, it would only be necessary to use the VPH procedure to characterize gasoline releases.

For these reasons, it was necessary and desirable to divide the aliphatic and aromatic hydrocarbon ranges of interest into six separate entities; three detected by the VPH method, and three detected by the EPH Method, as listed in Table 2-2.

**Table 2-2: Hydrocarbon Fractions of Interest**

Toxicologically Defined Hydrocarbon Fraction	Analytical/Program Defined Hydrocarbon Fraction	Analytical Method	Reference Dose (mg/kg/day)
C5-C8 Aliphatics	C5-C8 Aliphatics	VPH	0.04 <sup>a</sup>
C9-C18 Aliphatics	C9-C12 Aliphatics	VPH	0.1 <sup>a</sup>
	C9-C18 Aliphatics	EPH	0.1 <sup>a</sup>
C19-C36 Aliphatics	C19-C36 Aliphatics	EPH	2.0 <sup>a</sup>
C9-C22 Aromatics	C9-C10 Aromatics	VPH	0.03
	C11-C22 Aromatics	EPH	0.03

<sup>a</sup>updated value (2002)

### 2.3 Relationship of VPH/EPH to TPH and Gasoline Range Organics (GRO)

The relationship between TPH, GRO, VPH and EPH is graphically displayed in Figure 2-1.

**Figure 2-1: Relationship of GRO, TPH, VPH, and EPH**

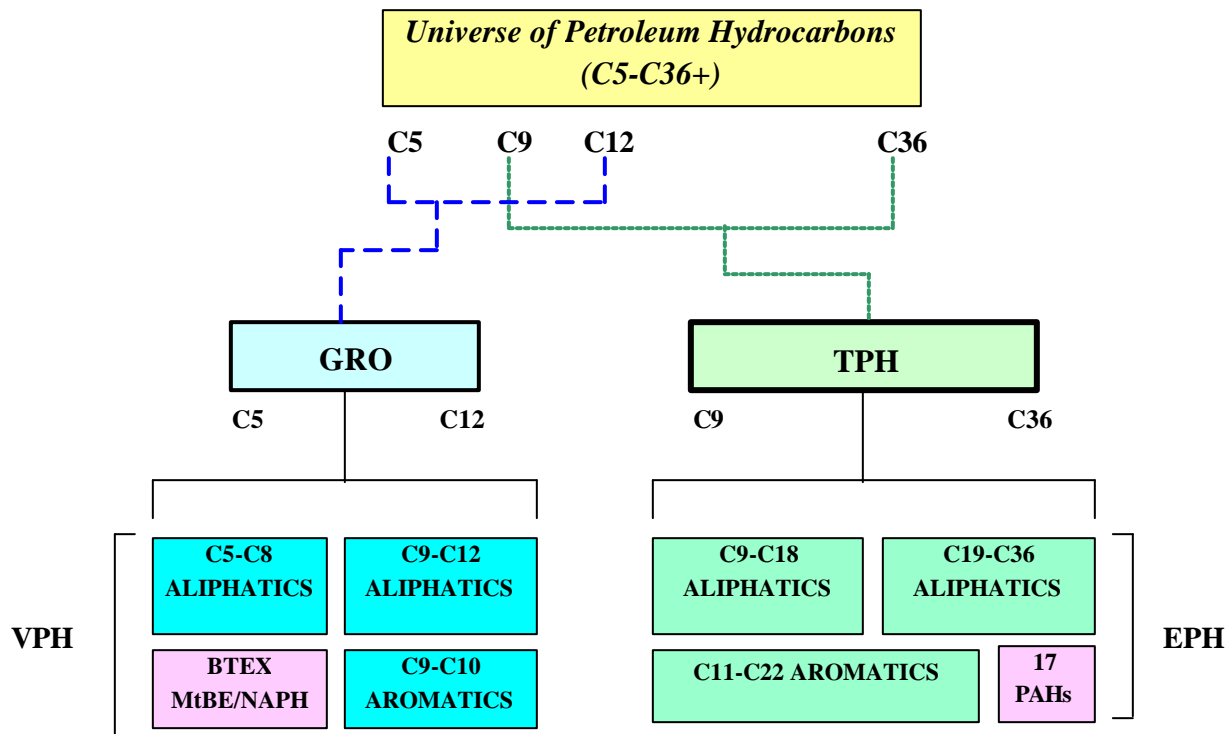

As can be seen in Figure 2-1, if the concentrations of the three EPH fractions and target PAH analytes were added together, it would be equal to a traditional “TPH” value. Similarly, if the three VPH fractions and BTEX/MtBE/naphthalene concentrations were added together, it would equal a GRO value.



It may also be noted that an overlap exists between the VPH and EPH methods, in that C9-C12 aliphatic hydrocarbons are quantitated by both methods. This overlap, further discussed in Section 4.2.3, is graphically illustrated in Figure 2-2.

**Figure 2-2: Overlap of VPH and EPH Test Methods**

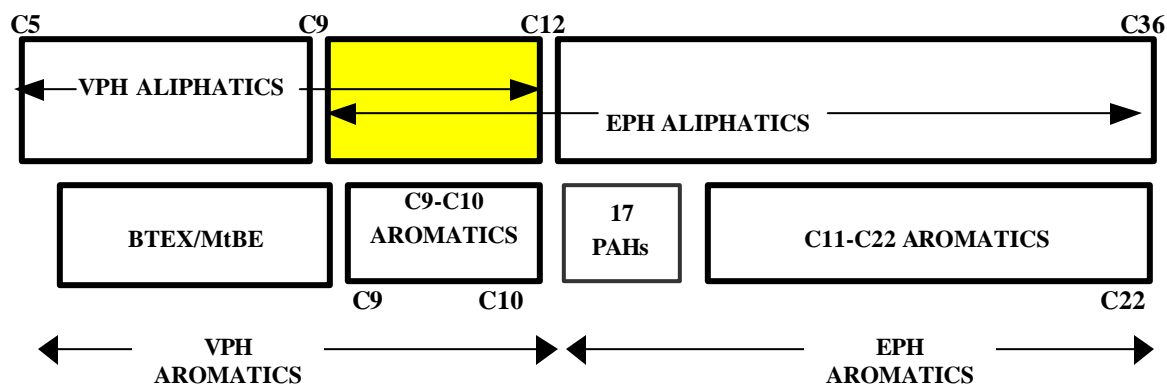

Note that there is no overlap in the aromatic fractions: the C9-C10 Aromatic fraction from the VPH method ends just before naphthalene, and the C11-C22 Aromatic fraction from the EPH method starts just after naphthalene.

## 2.4 Additional Research and Data Needs

MADEP continues to gather and review information and data on petroleum hydrocarbon chemistry and toxicity. Recent efforts have focused on the review and evaluation of previously unavailable oral and inhalation toxicological data, which has led to some revisions to the recommended RfD and RfC values for hydrocarbon fractions of interest (see Table 4-13). Additional study is also needed to better evaluate ecological risks posed by aliphatic and aromatic hydrocarbons.

On a national level, the Total Petroleum Hydrocarbon Criteria Working Group (TPHCWG) has published a number of documents relating to this subject. TPHCWG is comprised of representatives from the oil industry, Department of Defense, EPA, state agencies, environmental consulting firms, and academia. This group has recommended an aliphatic/aromatic fractional approach similar to the MADEP approach. Additional information and recommendations have also been provided on petroleum chemistry, hydrocarbon fate and transport, and analytical methodologies.

A number of TPHCWG publications are available on the World Wide Web at <http://www.aehs.com/>

## 3.0 ANALYTICAL METHODS

In order to use the VPH/EPH toxicological approach, it is necessary to be able to measure the collective concentrations of aliphatic and aromatic hydrocarbons in impacted media. Because conventional TPH and EPA test methods cannot produce this type of data, MADEP has developed and published two detailed analytical methods for Volatile Petroleum Hydrocarbons (VPH) and Extractable Petroleum Hydrocarbons (EPH). Both methods are gas chromatography (GC) techniques, and are modifications of traditional EPA procedures contained in SW-846. As such, most laboratories that have conducted volatile and extractable organic analyses in the past should be able to perform these techniques.

### 3.1 Gas Chromatography

Chromatography is the separation of compounds or groups of compounds in a complex mixture. In gas chromatography, hydrocarbons in a sample are transferred to the vapor phase by purging (VPH) or heating (EPH). The gaseous sample then flows through a (100 meter long +/-) *capillary column* to a detector. A chemical coating on the walls of the column first sorbs, and then desorbs each compound in the sample, with the heavier molecular weight compounds being "detained" longer than the lighter compounds. In this manner, analytes exit or *elute* from the column in a predictable and reproducible manner, based upon the structure, molecular weight, and boiling point of the compound.

Once they elute from the column, analytes pass through a detector, where the presence of each compound produces a small electrical current, proportional to its mass. This current is then amplified and used to produce a chromatogram, which is simply a plot of electrical (detector) response over time. Each peak on a chromatogram represents one or more individual compounds. Compounds are identified based upon their *retention times*, which is the time (in minutes) it takes the compound to travel through the column. Compounds or ranges of interest are quantitated by an *integration* process that calculates the area beneath the chromatographic peak(s), for comparison to mass/area ratios derived from the injection of *calibration standards* of known mass or concentration.

To transfer the hydrocarbons within a sample medium into a gas chromatograph, and into a gaseous phase, various sample preparation techniques may be used. Volatiles within water samples are generally *purged* with an inert gas, which strips the dissolved volatile compounds from the aqueous phase into the gaseous phase, where they are initially retained on a *trap* containing an appropriate sorbent. This trap is then rapidly heated to desorb the analytes, and load them onto a chromatographic column. Volatiles within soils are first extracted with a solvent (e.g., methanol), then mixed with water and purged. Heavier non-volatile hydrocarbons in both water and soil samples are generally extracted with a solvent (e.g., methylene chloride); the extract is then injected into a gas chromatograph, where it is heated and vaporized into a gaseous state.

A key and novel requirement of the VPH/EPH approach is the need to separate or *fractionate* hydrocarbon mixtures into collective groupings of aliphatic and aromatic hydrocarbons. This fractionation is something that is not done in conventional TPH or Gasoline Range Organic analyses, or the EPA volatile/extractable methodologies detailed in SW-846. There are several different ways to accomplish this task, each with advantages and disadvantages. The recommended MADEP analytical methods use detector selectivity and a chemical exchange process to fractionate samples, but other techniques may also be acceptable and cost-effective.

An example of an EPH (GC/FID) chromatogram of the aliphatic portion of a weathered #2 Fuel Oil soil sample is provided in Figure 3-1.

**Figure 3-1: Sample Chromatogram - #2 Fuel Oil**

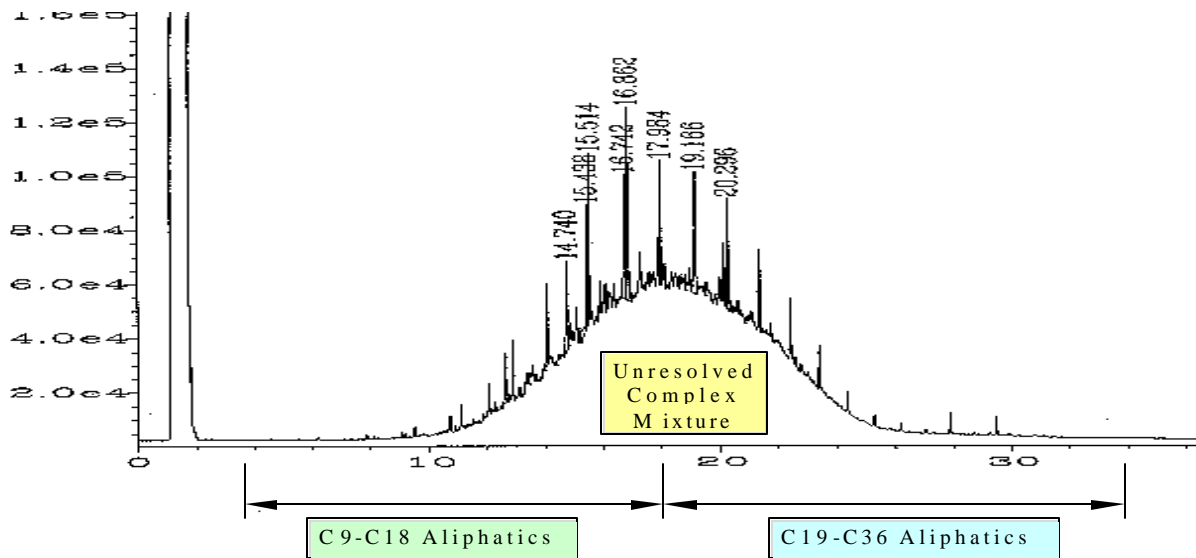

Note that the “x” axis is the retention time, in minutes, and the “y” axis is the detector signal strength. The retention time of some of the individual peaks are printed above those peaks. Note also the presence of a large chromatographic “hump” between 10 and 26 minutes, indicating the presence of an *Unresolved Complex Mixture (UCM)*; this feature is an important issue discussed in more detail below.

### 3.2 MADEP Analytical Methodologies

MADEP has developed and published two analytical methodologies for the detection of Volatile Petroleum Hydrocarbons (VPH) and Extractable Petroleum Hydrocarbons (EPH) in soil and water. Both methods separate complex hydrocarbon

mixtures into collective fractions of aliphatic and aromatic hydrocarbons, and produce data that can be directly compared to MCP *Method 1* cleanup standards. MADEP has also issued a draft methodology for the detection of Air-Phase Petroleum Hydrocarbons (APH), to identify and quantitate collective ranges of aliphatic and aromatic hydrocarbons in air and soil gas.

The VPH, EPH, and APH methods were developed to allow a meaningful evaluation of the risks posed by hydrocarbon mixtures. Other procedures may also be available to fulfill this objective, or, perhaps more importantly, other data quality objectives. For example, it may be more cost-effective to use (or initially use) EPA Method TO-14 to evaluate indoor air quality, and establish whether a subsurface hydrocarbon transport pathway is present at a disposal site; if there is no pathway, there is no need to evaluate risks via the APH procedure.

### 3.2.1 Volatile Petroleum Hydrocarbons (VPH)

The MADEP VPH Method (1998) is a *Purge and Trap, GC/PID/FID* procedure. Using this method, the collective concentrations of C5-C8 Aliphatic, C9-C12 Aliphatic, and C9-C10 Aromatic Hydrocarbons can be quantitated in soil or water matrices. In addition to these fractional ranges, the VPH method may also be used to concurrently identify and quantitate individual concentrations of the *Target VPH Analytes* benzene, toluene, ethylbenzene, and xylenes (BTEX); Methyl-tertiary-butylether (MtBE); and naphthalene.

Samples are analyzed using a *purge-and-trap* sample preparation/concentration procedure. The gas chromatograph is temperature-programmed to facilitate separation of hydrocarbon compounds. Detection is achieved by a photoionization detector (PID) and flame ionization detector (FID) in series. The PID chromatogram is used to determine the individual concentrations of Target Analytes and the collective fractional concentration of aromatic hydrocarbons in the C9 through C10 range. The FID chromatogram is used to determine the collective fractional concentrations of aliphatic hydrocarbons within the C5 through C8 and C9 through C12 ranges. Individual “marker” compounds are used to establish the beginning and end of the hydrocarbon ranges of interest.

The MADEP VPH method relies upon the selectivity of the PID detector to differentiate aromatic hydrocarbons from aliphatic hydrocarbons. Specifically, the PID will preferentially respond to hydrocarbon compounds with *pi* or double carbon (C=C) bonds, but will not respond well to hydrocarbon compounds with single carbon (C-C) *sigma* bonds. Because aromatic compounds have at least one benzene ring with three double bonds, they respond well to a PID; straight, branched, and cyclic aliphatic compounds with single carbon bonds respond poorly. Conversely, the FID is more of a universal detector, and will respond equally well to both aliphatic and aromatic hydrocarbons.

Because the PID can detect sample analytes without destroying them, compounds eluting from the chromatographic column are first passed through the PID, and then through the FID, where they are combusted in a hydrogen flame. In theory, the FID will detect the total concentrations of all petroleum hydrocarbons in the sample, and the PID will detect only (or mostly) aromatic compounds. By subtracting the PID from the FID response, it would be possible to quantitate just the aliphatic compounds. However, reality deviates from this theoretical ideal in the following ways:

- ◆ *Pi* bonds are present in hydrocarbon compounds other than aromatics - most notably alkenes, which are present in gasoline. Therefore, alkenes will be quantitated as aromatics. However, this bias is not deemed to be a major methodological limitation, due to the fact that (a) alkenes are typically not found in high concentrations in most petroleum products, and (b) alkenes may be more toxicologically similar to aromatics than to aliphatics.
- ◆ A more problematic issue is the fact that aliphatic compounds will produce some measurable response on a PID, especially heavier-molecular-weight branched and cyclic alkanes. Collectively, this response can become significant if there are a lot of these types of aliphatic compounds present, and will result in a falsely inflated quantitation of aromatics. Since a good portion of the hydrocarbons in the C9-C12 range of gasoline are in fact substituted aromatic compounds, this analytical overquantitation is not a major problem. However, other products, like kerosene and Jet A fuel, contain predominately aliphatic compounds within this range, and therefore use of the PID/FID approach can lead to significant overquantitation of the aromatic fraction.

Steps can be taken to minimize overquantitation of the aromatic fraction. Using a low energy PID lamp (e.g., 9.5 eV) will further diminish aliphatic response. Where essential, other techniques, such as chemical fractionation and/or use of a GC/MS approach, may be used to ensure more accurate data in this regard.

### 3.2.2 Extractable Petroleum Hydrocarbons (EPH)

The MADEP EPH Method (1998) is a *solvent extraction/fractionation GC/FID* procedure. Using this method, the collective concentrations of C9-C18 Aliphatic, C19-C36 Aliphatic, and C11-C22 Aromatic Hydrocarbons can be quantitated in soil or water matrices. In addition to these fractional ranges, the EPH method may also be used to concurrently identify and quantitate individual concentrations of the 17 Polycyclic Aromatic Hydrocarbon (PAH) *Target EPH Analytes*.

Soil and water samples are extracted with methylene chloride, solvent exchanged into hexane, and loaded onto a silica gel cartridge or column. The silica gel cartridge/column is rinsed with hexane to strip aliphatic compounds, and the resultant extract is collected and labeled. The silica gel cartridge/column is then rinsed with methylene chloride, to strip aromatic compounds, and the resultant extract is collected and labeled. The two extracts are then analyzed separately by direct injection into a temperature-programmed GC/FID. Individual target PAH compounds are identified by GC/FID analysis of the aromatic extract.

There are two important methodological elements that should be considered when reviewing EPH data:

- ◆ The MADEP EPH method relies upon a solvent-exchange/silica-gel-fractionation process to differentiate aromatic hydrocarbons from aliphatic hydrocarbons. This fractionation process is a sensitive yet critical element of the analytical approach; small errors at this stage can result in significant over or underquantitation of aromatic and aliphatic ranges. For this reason, the method specifies use of *Fractionation Surrogates* to verify proper separation of the aliphatic and aromatic fractions.
- ◆ Like any GC/FID procedure, an *unresolved complex mixture (UCM)* or “hump” will typically be observed on the chromatogram of a heavier molecular weight petroleum product, particularly weathered products. (See Figure 3-1). A UCM is produced when many individual hydrocarbon compounds are eluting from the capillary column at the same time, overwhelming and preventing the detector signal from returning to baseline. Nevertheless, it is important that these compounds are included in the sample quantitation calculation, and for that reason the EPH method specifies the use of a *forced or projected baseline* when integrating chromatographic areas of fractional ranges. **If a laboratory does not takes steps to ensure this integration technique, resultant fractional range data may significantly under-report true hydrocarbon concentrations.**

The EPH method also contains an option to forego the solvent-exchange/silica-gel-fractionation process, to obtain a Total Petroleum Hydrocarbon (TPH) concentration. While this data will provide little information on the chemistry or toxicity of the petroleum mixture, it can provide a cost-effective analytical screening value, for comparison with TPH reporting and cleanup standards.

### 3.2.3 Air-Phase Petroleum Hydrocarbons (APH)

The draft MADEP APH method (2000) is a *GC/MS* procedure. Using this method, the collective concentrations of C5-C8 Aliphatic, C9-C12 Aliphatic, and C9-C10 Aromatic Hydrocarbons can be quantitated in air or soil gas matrices. In addition to these fractional ranges, the APH method may also be used to concurrently identify and quantitate individual vapor-phase concentrations of the *Target APH Analytes* 1,3-butadiene, benzene, toluene, ethylbenzene, and xylenes (BTEX); Methyl-tertiary-butylether (MtBE), naphthalene, and 2-methylnaphthalene.

Samples are collected in SUMMA ® passivated stainless steel canisters (other collection techniques are permissible and may be more appropriate for certain data quality objectives). A specified volume of sample is withdrawn from the canister through a mass flow controller using a vacuum pump. The sample is cryogenically concentrated to a volume of less than one mL in a nickel trap filled with nonsilanized glass beads. Following preconcentration, the sample is refocused at the head of a capillary column on a gas chromatograph using a cryofocusing accessory. This step further reduces the sample volume to less than one microliter for injection.

The sample is then injected into a gas chromatograph, which is used to separate the compounds and hydrocarbon fractions of interest. All compounds are detected using a mass spectrometer. Target APH Analytes are identified and quantitated using characteristic ions. Collective concentrations of C<sub>9</sub>-C<sub>10</sub> Aromatic Hydrocarbons are quantitated using extracted ions. Collective concentrations of aliphatic hydrocarbon fractions are quantitated using a total ion chromatogram, subtracting out Target APH Analytes and C<sub>9</sub>-C<sub>10</sub> Aromatic Hydrocarbons. It is important to note that the final APH method may contain modifications of the above procedures.

Air testing, whether by the APH procedure or other methodologies, is a specialty service that is not as widely available as soil and water analytical services. However, unlike the VPH and EPH methods, MADEP does not expect use of the APH method will be required at most petroleum contaminated sites, for the reasons listed below:

- ◆ Most releases of petroleum products do not result in an indoor air impact;
- ◆ For those sites where an indoor air impact is a potential concern, it is usually possible to evaluate and/or rule-out indoor air contamination problems using low-cost soil gas analytical screening techniques, as further detailed in Section 4.3.1; and
- ◆ Where indoor air sampling is required to evaluate a potential subsurface vapor transport pathway, traditional EPA procedures (e.g., EPA Method TO-14) may be used to determine if an impact is likely (based upon concentration of target analytes and qualitative presence of hydrocarbon peaks). The use of the APH (or similar) procedure would only be necessary if contamination is confirmed, and a quantitative risk assessment is required.

### 3.3 VPH/EPH Target Analytes

Although both the VPH and the EPH methods are capable of providing quantitation of Target Analytes (concurrent with the quantitation of aliphatic and aromatic ranges), because they are GC methods which identify analytes solely on the basis of retention times, they can produce “false positive” or over-inflated concentration data for these individual compounds. For example, the large peak eluting at 14.740 minutes in Figure 3-1 may be identified by the EPH method as hexadecane, because a hexadecane standard run as part of the calibration procedures eluted at this retention time. However, it is possible that hexadecane is not present in this sample at all, and some other (unknown) hydrocarbon compound is present which elutes at precisely this same time; or it is possible that hexadecane is indeed present, but that 2 or 3 other hydrocarbon compounds are *co-eluting* with hexadecane at precisely this time, which will lead to an overquantitation of the hexadecane concentration.

Although the sample-extract cleanup and fractionation procedures specified in the EPH method will tend to minimize interferences of this nature (by removing aliphatic compounds that may co-elute with the PAH Target Analytes), the only way to get positive identification and quantitation of these Target Analytes is to use a GC/MS analytical technique, like EPA Method 8270 for the PAHs, and EPA Method 8260 for BTEX/MtBE. For this reason, a laboratory may advise a client to use the VPH and EPH methods to quantitate the aliphatic/aromatic fractional ranges, but a GC/MS method to quantitate individual (Target) analytes. This approach is acceptable, although it may increase analytical costs.

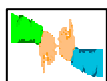

*To save money, it may be a worthwhile gamble to quantitate Target Analytes using the VPH/EPH Methods for samples that are believed to be relatively free from contamination - for example, when trying to confirm a “clean closure” at a tank removal site. If significant concentrations of Target Analytes are in fact found to be present, a re-analysis can be done using GC/MS, to provide a definitive determination in this regard (if the laboratory was instructed to retain the sample extract from the VPH/EPH samples, the cost for this re-analysis would be reduced).*

### 3.4 Sampling Procedures and Requirements for the VPH/EPH Methods

Sample collection and preservation are critical elements in the VPH and EPH methodologies. A summary of requirements in this regard is provided in Table 3-1; detailed step-by-step sampling recommendations are provided in Appendix 1.

Sample preservation is essential. **VPH and EPH aqueous samples must be preserved in a manner that prevents biodegradation of hydrocarbons. Simply cooling these samples is not sufficient.** Biodegradation can be prevented by addition of acids (e.g., HCl to pH <2) or by the addition of bases (e.g., Trisodium Phosphate Dodecahydrate to pH > 11). *Note that acid preservation can significantly degrade levels of MtBE in aqueous samples (see Appendix 1).*

**VPH soil samples must be preserved in a manner that (1) prevents sample losses due to volatilization, and (2) prevents sample losses due to biodegradation.** There is now considerable evidence and data demonstrating substantial losses of volatile petroleum hydrocarbons from unpreserved sampling containers. The recommended preservation technique is to immerse VPH soil samples in methanol *at the time of collection*. Alternative techniques will be considered only if sufficient data are available to demonstrate the efficacy of sample preservation. Currently, only one alternative has been shown to provide acceptable preservation: the use of specially designed sealed-tube devices that obtain an air-tight soil sample.

**Table 3-1: Sample Collection, Preservation, and Holding Times**

Method	Matrix	Container	Preservation	Holding Time
VPH	Aqueous	40 mL VOC vial w/Teflon-lined septa screw caps; fill completely to zero headspace	pH <2 (add 3-4 drops of 1:1 HCl); cool to 4°C. Where MtBE is of concern, use 0.40– 0.44 grams TSP to raise pH > 11 (see Appendix 1)	14 days
	Soil	VOC vial or container; add 15g to 40mL vial; 25g to 60 mL vial	1 mL methanol per 1g soil (+/- 25%); cool to 4°C	28 days
EPH	Aqueous	1-Liter amber glass bottle with Teflon-lined screw cap	pH<2 (add 5 mL of 1:1 HCl); cool to 4°C	Extract within 14 days; analyze extract within 40 days
	Soil	4-oz (120 mL) +/- widemouth amber glass jar with Teflon-lined screw cap	cool to 4°C	Extract within 7 days; analyze extract within 40 days

Such devices have been shown to maintain sample integrity for 48 hours, by which time the sample must be extruded and preserved in methanol. Additional detail on the preservation of VPH aqueous and soil samples is provided in Appendix 1. Information and guidance on shipping methanol-preserved samples is contained in Appendix 2.

### 3.5 Modifications of the VPH/EPH/APH Methods

The MADEP VPH, EPH, and APH analytical techniques are “performance-based” methods, which means that modifications to specified procedures are allowable, as long as acceptable performance is demonstrated and documented.

The most common modification of the VPH and EPH methods involves the use of a GC/MS technique to identify and quantitate collective ranges of aliphatic and/or aromatic hydrocarbons. Under this approach, a mass spectrometer is used to break up the hydrocarbon molecules in a sample into fragments with certain masses and charges. A computer program is then used to search for specified fragments that are indicative of an aliphatic and/or aromatic hydrocarbon structure. Quantitation of a collective hydrocarbon range is accomplished by comparing the total mass of these selected fragments with the mass of fragments produced by calibration standards.

While MADEP believes that a GC/MS approach has promise, it has not yet issued guidelines or recommendations in this regard. Until such time as this occurs, all laboratories conducting such modifications must be able to provide complete documentation on their procedures, and must be able to demonstrate that their methodology is capable of generating data of a known level of accuracy and precision. Specific questions that a data user might want to address to laboratories include:

- ◆ *What “ions” (fragments) were used to quantitate specific aliphatic and/or aromatic hydrocarbon ranges? How were these ions chosen? Because hydrocarbon molecules fragment in different manners and proportions, how do the fragmentation patterns of the calibration standards correlate to the fragmentation patterns of the hydrocarbons likely contained in the sample?*
- ◆ *What studies did the laboratory do to validate the method? Were “neat” petroleum products analyzed? Fresh and/or “weathered”?*
- ◆ *Based upon the choice of quantitating ions and the results of the validation studies, under what (sample chemistry) conditions would a positive or negative identification and/or quantitating bias be expected?*

While MADEP encourages laboratories to develop “better mouse traps”, ultimately, it is the responsibility of the data user to determine the validity and application of data obtained from modified methods. Parties unfamiliar with analytical chemistry and/or laboratory operations are advised to seek expert advice in such matters, and understand the nature, extent, and implication of all method modifications.

### 3.6 Data Quality and Report Content

Because the VPH and EPH methods are performance-based, and because MADEP does not (at this time) have a laboratory certification program for non-drinking/non-wastewater matrices, it is incumbent upon the laboratory and data users to take steps to ensure and document the quality of analytical data, consistent with the provisions and requirements of 310 CMR 40.0017.

The VPH and EPH methods have detailed and specific Quality Assurance and Quality Control (QA/QC) requirements, and a required data reporting content, which is provided in Appendix 3. The reporting content is designed to ensure that data users can easily ascertain (1) what is being reported, (2) basic sample and QA/QC information, (3) whether significant modifications were made to the recommended methods, (4) whether all recommended QA/QC steps were taken, and (5) whether all specified QA/QC and performance standards were met. *While it is not necessary to obtain and provide data in exactly the same form and order detailed on the reporting sheets provided in Appendix 3, data users should insist that all indicated information and statements be provided.*

Although a comprehensive review of all QA/QC information and data is beyond the ability and/or resources of most data users, there are several quick and easy steps that can and should be taken to help ensure the accuracy and reliability of VPH/EPH/APH data, by simply reviewing the information and data required in the data report:

- ◇ ***All sample information specified in Appendix 3 should be provided, describing the sample matrix, condition of containers, and sample preservation.*** VPH samples that were not preserved in the field with methanol (or sampled/preserved in an acceptable alternative manner) are highly suspect.
- ◇ ***The dates of sample collection, receipt by laboratory, extraction (EPH) and analyses should be provided.*** Samples held beyond the recommended holding times are suspect, especially EPH soil samples that are preserved only by refrigeration.
- ◇ ***A percent moisture value should be reported for all soil samples,*** to ensure that such data have been adjusted to a “dry weight” reporting basis.
- ◇ ***The analytical units must be clearly indicated,*** and should be appropriate for the matrix under evaluation (i.e., µg/g, mg/kg, or µg/kg for soil; µg/L or mg/L for water; µg/m<sup>3</sup> or ppbv for air).
- ◇ ***Reporting Limits (RLs) should be specified for each aliphatic and aromatic range and each Target Analyte.*** The VPH, EPH, and APH methods contain specific procedures and requirements on how to establish Reporting Limits, which are the minimum concentration values that a laboratory can discern and report with sufficient confidence. These values must be experimentally determined by each laboratory. Note that expected RLs for the aliphatic and aromatic ranges in water are between 50 and 100 µg/L; expected RLs for the aliphatic and aromatic ranges in soil are between 2 and 10 mg/kg; expected RLs for the aliphatic and aromatic fractions in air are between 25 and 100 µg/m<sup>3</sup>.
- ◇ ***The percent recovery of sample surrogates should be provided, along with the acceptable range.*** A surrogate is a (non-petroleum) chemical compound added (“spiked”) into each VPH and EPH water and soil sample prior to extraction and analyses. The purpose of surrogate spiking is to determine the efficiency and accuracy of sample extraction (EPH), sample purging (VPH), and instrument analyses. Surrogate recovery is expressed in terms of percent recovery; for example, if 1000 µg of the surrogate compound ortho-terphenyl (OTP) is spiked onto a 10 gram soil sample that is to be analyzed by the EPH method (yielding a theoretical concentration of 100 µg/g), and the resultant analysis quantified OTP at 70 µg/g, the percent recovery would be 70%. Although sample data with surrogate recoveries outside of the stated acceptance range should be carefully evaluated, they need not be summarily dismissed or considered categorically unusable. For example, data associated with a surrogate recovery greater than specified limits may be appropriate to use as an “upper limit” value; data associated with a surrogate recovery lower than specified limits may be appropriate to use as a “lower limit”, and would constitute knowledge of a release if exceeding Reportable Concentrations. Note that low recoveries are not uncommon (or unexpected) in clay/organic soil matrices. Also, low recoveries of sample surrogates may be observed in VPH soil samples with high moisture content.
- ◇ ***For the EPH Method, the percent recovery of Fractionation Surrogates should be provided, along with the acceptable range.*** In the EPH method, a sample extract is loaded onto silica gel, followed by a hexane rinse, to

remove and collect aliphatics, and a methylene chloride rinse, to remove and collect aromatics. However, because of the weakly polar nature of naphthalene and substituted naphthalenes, they are easily “stripped” into the aliphatic fraction - an especially problematic occurrence in water samples, as the naphthalenes constitute a large percentage of the water-soluble fraction of fuel oils. To monitor whether this action is occurring, Fractionation Surrogates are added directly to the sample extract just prior to the silica gel fractionation step (as opposed to the sample surrogates, which are added to the soil and water samples prior to extraction, to evaluate extraction efficiency). The currently recommended Fractionation Surrogates are 2-Fluorobiphenyl and 2-Bromonaphthalene - two compounds that are not normally present in petroleum, and that have polarities similar to naphthalene. Both compounds should be detected in the aromatic fraction within the specified acceptable percent recovery ranges.

Note: Changes and refinements to the EPH Method may affect the use and selection of Fractionation Surrogates.

- ◇ ***The laboratory should clearly indicate whether the reported VPH/EPH/APH fractional range concentrations include or do not include the concentration of Target Analytes, and the range(s) in which the Target Analytes elute.*** By definition, these ranges exclude Target Analytes, which are evaluated separately. (Absent this exclusion, Target Analytes like BTEX and PAHs would be “double counted” - once in the collective range concentrations, and once in a separate Target Analyte evaluation). If the laboratory did not subtract out the concentrations of these Target Analytes (perhaps they only provided range data), the data user may make this adjustment. It is also permissible for a data user to adjust a range concentration value by excluding the concentration(s) of non-petroleum analytes eluting within that hydrocarbon range (e.g., TCE eluting within a C5-C8 Aliphatic Hydrocarbon range). Note that unadjusted data are also acceptable to MADEP - they are just overly conservative.
- ◇ ***The laboratory must clearly indicate whether significant modifications were made to MADEP VPH/EPH/APH methods, and if so, should detail the nature and extent of these modifications.*** Examples of “significant modifications” are specifically listed in Section 11 of each method. Note that MADEP encourages innovation, where appropriate.
- ◇ ***The laboratory should clearly indicate whether it has followed and met the QA/QC program and performance standards specified by the MADEP VPH/EPH/APH Methods.*** Such an affirmation is contained in the required laboratory report content. Note that on some samples, it will not be possible to meet all QA/QC specifications, and that such data need not be summarily dismissed as unacceptable, as long as an appropriate explanation is provided, and as long as limitations inherent in the data are acceptable for the given application and use of the data.
- ◇ ***A report narrative should be provided, if necessary, to document and explain any deviations from the method, analytical problems, and/or QA/QC issues.*** Laboratories using modifications of the method should have on file a written Standard Operating Procedure, which should be referenced or provided as appropriate. While a failure to perform or meet the data reporting and performance standards specified above does not necessarily mean that the provided data are not of sufficient quality, it does place the burden on the data user to make this determination.
- ◇ ***The laboratory should certify under the pains and penalties of perjury that the information contained in the data report form is accurate and complete.*** This attestation should be done via the signature of a responsible laboratory representative.

While minimum standards are specified in the methods, to ensure a minimum level of quality for all data, there is an expectation that laboratories should be able to achieve better results on most samples. In selecting a laboratory, a data user should make sufficient inquiry into the experience of the laboratory performing these (and any other) analytical methods, and on the QA/QC program in operation to monitor, document, and improve analytical quality. In addition, the scope of laboratory services should be negotiated and clearly articulated “up front”, to ensure that the data user is procuring (and the laboratory is receiving compensation for) all desired information and data (e.g., QA/QC data, narrative reports, data usability discussions, etc.).

Additional guidance and recommendations on data quality issues for the VPH/EPH methods (as well as most other common EPA methods) can be downloaded from MADEP at: <http://www.state.ma.us/dep/bwsc/files/data/QAQCDocs.htm>

**Analytical data and testing should not be viewed as a commodity, but as a highly technical and sophisticated professional service, requiring the same level of scrutiny and oversight as any other professional service that will be relied upon by a Licensed Site Professional in rendering a waste site cleanup opinion.**



### 3.7 Other Hydrocarbon Testing Methods

The VPH and EPH methods were developed to provide data on the chemistry and toxicity of complex hydrocarbon mixtures, to facilitate risk evaluations and to complement MADEP Method 1 cleanup standards. However, in cases where the total concentrations of hydrocarbons are relatively low, use of these fractionation procedures may be “overkill”, and a “total petroleum hydrocarbon” (and Target Analyte) evaluation may suffice. Moreover, risk characterization is not the only site assessment objective or concern at disposal sites; other characterization needs may include: petroleum product identification, petroleum source identification, and/or Remediation Waste characterization. In these cases, other analytical procedures may be more appropriate and cost-effective.

A summary of other possible analytical approaches and methodologies in this regard is provided in Table 3-2.

**Table 3-2: Other Analytical Approaches**

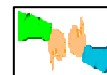

Objective	Analytical Approach	Conditions/Caveats/Comments
Characterization of Remediation Wastes	TPH, VOCs, and/or jar headspace screening. Metals, PCBs and/or TCLP often required	Need to check with disposal or recycling facility for requirements
Risk Assessment & Compliance with Cleanup Standards	TPH via an appropriate methodology. Characterize Target Analytes as needed with EPA SW-846 methodologies	Applicable for low levels of C9 and heavier hydrocarbons (i.e., when TPH concentrations will likely < TPH cleanup standards)
Determining Type of Petroleum Product	High resolution GC/FID; advanced GC/MS chemical fingerprinting	Also recommended to differentiate petrogenic vs. pyrogenic PAHs
Determining Source of Petroleum Product	High resolution GC/FID; advanced GC/MS chemical fingerprinting; quantitation of biomarkers	Not always definitive; requires interpretative expertise

#### 3.7.1 Total Petroleum Hydrocarbons (TPH)

Though a widely used and conceptually-simple testing parameter, there is no universal definition of TPH, and the term is essentially defined by the analytical method chosen by the laboratory. To further complicate this matter, many laboratories use undefined and inconsistent “modifications” of published methodologies to detect and quantitate TPH concentration values (e.g., Modified EPA Method 8100). This situation has led to a significant degree of confusion over the application, comparability, and quality of TPH data.

The MCP provides a definition of TPH at 310 CMR 40.0006:

*Total Petroleum Hydrocarbons and TPH each mean the total or cumulative concentration of hydrocarbons with boiling points equal to or greater than 150°C [C<sub>9</sub>] and associated with a petroleum product, as measured by standard analytical techniques and/or by procedures approved by the Department, excluding the individual compounds listed at 310 CMR 40.0974(2).*

This definition reflects the fact that the vast majority of “TPH” analyses traditionally conducted in Massachusetts involved the use of an extraction solvent (e.g., Method 418.1), which leads to the loss of lighter hydrocarbons (<C<sub>9</sub>) present in the sample. Based upon this definition, the following rules and recommendations would apply to parties electing to use a TPH analytical method to support a risk assessment or document compliance with an MCP Method 1 TPH cleanup standard:

- The TPH method and resultant data may only be used to characterize releases of petroleum products that consist of hydrocarbons primarily in the C<sub>9</sub> to C<sub>36</sub> range. In other words, it may only be used in lieu of an EPH procedure, not a VPH procedure. Guidance on when an EPH procedure is appropriate is contained in Table 4-6.
- In addition to the TPH analysis, all appropriate Target Analytes must also be addressed. Guidance in this regard is contained in Tables 4-3 and 4-5.

- For analytical procedures that utilize a GC/FID technique, the TPH quantitation value must be based upon the integration to baseline of all peak areas from n-Nonane (C9) to n-Hexatriacontane (C36).
- As the MCP specifically excludes “individual compounds listed at 310 CMR 40.0974(2)” from its definition of TPH, it is acceptable to adjust gross TPH values by subtracting out the collective concentrations of these individual compounds. Note that, for all intents and purposes, the “individual compounds listed at 310 CMR 40.0974(2)” are synonymous with the EPH Target Analytes listed in Tables 4-3 and 4-5.

While the MCP defines TPH to be C9 and heavier hydrocarbons, there are some TPH and/or “Gasoline Range Organics” methodologies that may collectively quantitate lighter hydrocarbons in the range of C5-C12. Typically, these methods involve the use of a purge-and-trap or headspace development technique, followed by a GC/FID analytical procedure. While these procedures may NOT be used to obtain TPH data for comparison to the MCP Method 1 cleanup standards (because of the definition of TPH at 40.0006), they can be used as a screening tool for VPH range contaminants. Specifically, if the TOTAL concentration of hydrocarbons within the C5-C12 range (excluding VPH Target Analytes) is less than the lowest VPH Method 1 standard (usually C9-C10 Aromatic Hydrocarbons), it would be safe to assume that hydrocarbon levels are within all fractional standards.

While use of TPH methods may offer certain advantages, it is the responsibility of the party using and submitting such data to ensure that the specific technique and procedure(s) used is appropriate for the disposal site in question, and that appropriate Quality Assurance and Quality Control (QA/QC) measures are taken to monitor and document the quality and usability of the generated data. In general, MADEP expects all such methods to achieve a level of QA/QC consistent with the VPH and EPH methods.

A tabulation of commonly and/or historically available TPH analytical techniques is provided in Table 3-3.

**Table 3-3: Common/Available TPH Testing Methods**

Method	Technique	Comments
MADEP EPH	Extraction with methylene chloride & GC/FID analysis	Use in the “TPH” screening mode by eliminating the fractionation step per Section 1.5 of EPH Method
EPA Method 1664	Extraction with n-hexane & gravimetric analyses	New method (1999) to replace Method 418.1 (Freon extraction with IR analyses)
Modified EPA Method 8100	Extraction with appropriate solvent & GC/FID analysis	Must ensure quantitation in C9-C36 range with forced baseline integration if data is used to support MCP TPH cleanup standard
Modified EPA Method 8015	Purge-and-trap or headspace sample preparation & GC/FID analysis	Must ensure quantitation in the C5-C12 range with forced baseline integration if data is to be used to screen samples for compliance with MCP VPH cleanup standards

### 3.7.2 Environmental Forensic Techniques

In conducting a characterization of a petroleum-contaminated site, it may be necessary and/or desirable to identify the types of petroleum product present and/or the source of their release to the environment. In recent years, new analytical testing techniques have evolved to facilitate evaluations of this nature, and support an evolving specialization known as “environmental forensics”.

In order to identify the types and/or source of petroleum products that were detected at a site, (up to) a three-step analytical regiment is recommended:

- Initially, samples should be analyzed by a high-resolution gas chromatography/flame ionization detection (GC/FID) methodology. Such techniques have been utilized for many years, and are a useful “first cut” to help identify the boiling-point range of the hydrocarbon mixtures present in the sample, which can then be used to make judgments on the type(s) of petroleum product(s) released at the site (e.g., #2 fuel oil vs. #6 fuel oil). In some cases, the data obtained in this manner is sufficiently conclusive to satisfy site characterization objectives.

In other cases, however, the contamination is highly weathered, and/or intermingled with hydrocarbons of pyrogenic origin (e.g., coal ash, soot, engine emissions).

- In situations where a GC/FID evaluation is inconclusive, additional analytical characterization by a gas chromatography/mass spectrometry (GC/MS) “advanced chemical fingerprinting” technique may be advisable. These methodologies focus on the identification and quantitation of polycyclic aromatic hydrocarbons (PAHs). Although most people are familiar with the 17 priority pollutant PAH compounds quantitated by the MADEP EPH method and EPA Method 8270, there are in fact many more PAH compounds present in petroleum products. Using a GC/MS technique and sophisticated quantitation algorithm, it is possible to identify and quantitate collective groupings of these PAH compounds based upon their structure, e.g., naphthalene with a side chain containing 1 carbon atom; naphthalene with a side chain containing 2 carbon atoms, etc. The presence and distribution of these side chains can then be used to help establish the type of petroleum product(s) present at the site. Moreover, this same information – often plotted as histograms – may also be used to differentiate petroleum-derived (petrogenic) hydrocarbons from combustion-derived (pyrogenic) hydrocarbons (given that the latter are predominated by the parent PAH compound, while the former are predominated by the alkylated side chain PAH compounds).
- Data on the distribution of alkylated PAHs can often provide definitive information on the type(s) of petroleum products present at a site, and even some evidence on the specific source(s) of release. However, in order to obtain more definitive proof of the source of a petroleum release, one additional analytical tool should be considered: the identification and quantitation of biomarkers. Biomarkers are chemical compounds present in petroleum products that are the remnants of the biological life (e.g., algae, plants, bacteria) that help create the parent crude oil. While certain biomarkers are identifiable using a GC/FID methodology (e.g., pristane and phytane), the most useful compounds in this regard (e.g., terpanes and steranes) are identified using a GC/MS technique in a selected ion monitoring (SIM) mode. Because each crude oil source has a distinct “fingerprint” of biomarkers, it is often possible to identify the specific source of a release of petroleum at a site using this approach (e.g., using a statistical/multivariate component analyses), though weathering processes may sometimes decrease confidence in such conclusions.

At the present time, advanced chemical fingerprinting is an innovative technology used by only a small number of laboratories. Given this status, and given the sophistication, complexity, and professional judgment inherent in these approaches, it is essential that data users seek out facilities and personnel with the appropriate expertise and experience.

### 3.8 Analytical Screening Techniques

The use of analytical screening techniques is encouraged, to provide timely and cost-effective data. As the sophistication and reliability of so-called “field” methods continue to increase, the distinction between conventional laboratory and analytical screening techniques becomes less defined, and less important. However, with this increased capability and performance comes an increased need to demonstrate and document a commensurate level of quality assurance/quality control (QA/QC), consistent with the provisions and requirements of 310 CMR 40.0017.

Various levels/approaches are possible:

- ◇ Screening techniques may be used solely to direct remedial actions and/or sampling programs for conventional VPH/EPH testing. Because such screening data will not be used in a “stand alone” capacity, QA/QC requirements are not as critical.
- ◇ Screening techniques may also be employed to obtain data that will be used, in whole or in part, to assess risks and/or determine compliance with cleanup standards, and/or to support the representativeness of (“lab”) data used in the risk assessment process. While it is understood that such screening methodologies may lack the qualitative or quantitative accuracy of conventional VPH/EPH testing, *the same level of QA/QC will be expected, within the limits and bounds of the stated application of the data.*

The use of screening techniques depends upon, or may be enhanced by, the use of assumptions and conditions. This approach is acceptable, as long as conservative assumptions are made, and the use of such methods and assumptions are appropriate, given contaminant chemistry, site conditions, and area receptors. A tabulation of commonly used screening techniques, and recommended applications and *Rules of Thumb*, are provided in Table 3-4.

**Table 3-4  
VPH/EPH Analytical Screening Techniques**

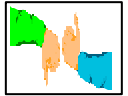

Technique	Description	Range	Applications	Limitations	Recommendations
PID/FID Headspace	Soil or water sample is placed in sealed container & headspace is allowed to develop. PID and/or FID meter is then used to test the headspace for total volatile organic compounds (VOCs). Reference: Recommended DEP jar headspace procedure	VPH	Excellent screening tool for gasoline; good tool for kerosene, jet fuel and fresh fuel oil. Best used to direct remedial operations, and provide first-cut site characterization data. PID preferentially responds to the more toxic aromatic compounds.	Not appropriate for heavy mineral/lube/fuel oils or weathered diesel/#2 fuel oil. PID can be non-linear and/or erratic for gasoline headspace vapors > 150 ppmv. PID response lessened by high humidity/ moisture (instrument dependent). Additional confirmatory analyses usually required.	For gasoline, excluding clays & organic soils, headspace readings less than 100 ppmv usually means that all VPH fractions are below 100 µg/g. Confirmatory analyses needed.
PID/FID Soil Gas	Soil gas is extracted from a probe and analyzed with a PID and/or FID meter. Reference: see Section 4.3.1.1	VPH & EPH	Use to investigate soil gas/indoor air pathways, and evaluate sites with g.w. concentrations > GW-2 Method 1 standards. PID preferentially responds to the more toxic aromatic compounds.	Instrument response is flow-dependent; must ensure adequate flow rates. PID response affected by high moisture & high petroleum vapor concentrations (>150 ppmv). FID will respond to pipeline/naturally-occurring methane.	See recommendations in Section 4.3.1.1 and Table 4-9.
UV Fluorescence & Absorbance	The absorbance or fluorescence of a UV light source is used to directly quantitate the aromatic content of soil sample. Extraction solvent, such as methanol or Isopropyl alcohol, must be used. Reference: ASTM 5831-95	VPH & EPH	Good screening tool for petroleum products with significant aromatic content (e.g., diesel/#2 fuel oil and gasoline). UV Fluorescence has lower detection limits than absorbance, but is not as linear. UV methods target the more toxic aromatic fractions.	Does not respond to aliphatics; not appropriate for petroleum products that are primarily aliphatics (mineral oils or dielectric fluids). May pick up naturally occurring humic acids - calcium oxide can be used to decrease interference.	Calibrate with aromatic standard, like C11-C22 EPH standard, for direct measurement of aromatic hydrocarbons. For diesel/#2 fuel oil, assume aliphatic content is twice aromatic. This approach may significantly over-predict aliphatic content of highly weathered diesel/#2 fuel oil. Confirmatory analysis recommended for representative/worst-case samples.
Emulsion-Based TPH Methods	Hydrocarbons are extracted from a soil sample with a solvent (e.g. methanol), and a surfactant is added to create an emulsion. Optical sensor is used to measure extract turbidity	EPH	Gives "TPH" screening values, quantitating both aromatic and aliphatic hydrocarbons. Best correlation shown with diesel/#2 fuel oil.	Does not discriminate between aliphatics and aromatics. Interference possible in organic-rich and clay soils. Not recommend for gasoline.	For diesel/#2 fuel oil, assume 60% C11-C22 Aromatics and 40% C9-C18 Aliphatics.
Immunoassay Test Kits	Soil or water samples analyzed by antibody-antigen reaction. Enzyme conjugates used to allow colorimetric analysis of antigen (contaminant) conc. Soil extraction with methanol. Reference: EPA 4030/4035	VPH & EPH	Can be used to detect specific compounds or groups of compounds (e.g., BTEX and PAHs). "TPH" methods usually target naphthalene, and assume correlation to TPH.	Because antibodies bind with specific antigens (contaminants), cannot directly quantitate collective aliphatic/aromatic fractions or total hydrocarbons. Not effective for lube/hydraulic oils.	No general assumptions can be made. Each kit and application has to be individually evaluated.
Fiber-Optic Chemical Sensors	Probe with hydrophobic/organo-phyllic optical fiber is lowered into a well. Change in refraction index used to est. hydrocarbon conc. in groundwater	VPH & EPH	Allows in-situ measurements of volatile and semi-volatile dissolved hydrocarbons. Results calibrated to a p-xylene response. In-situ vapor measurement also possible.	Response decreases with increasing solubility; response to benzene 10 times less than p-xylene. Significant calibration/cleaning requirements between uses.	Insufficient information available to offer general recommendations.

### 3.8.1 Principles of Operation, Biases, and Calibration

All screening techniques and instruments are predicated upon certain principles of operation, detection, and calibration. Many have limitations and biases that need to be understood and accommodated. For example, an immunoassay “TPH” test method may be designed to detect the presence of naphthalene, and then extrapolate a TPH concentration based upon an assumption on the percentage of naphthalene in fresh fuel oil. Thus, two important assumptions and biases are present: (a) the concentration of a single compound (naphthalene) can be used to determine the concentration of a product which is made up of numerous (perhaps hundreds of) hydrocarbon compounds, and (b) the chemistry of a fresh fuel oil standard can be used to estimate the chemistry of a field sample. As such, a highly weathered fuel oil sample, or a fuel product low in naphthalene (e.g., mineral oils) may not yield reliable results.

To effectively use analytical/screening techniques, especially for risk and cleanup decisions, it is incumbent upon the data user to:

1. understand the application and limitations of the screening method(s) of interest;
2. consider site-specific contaminant/mixture chemistry and fate/transport processes; and
3. determine the precision and accuracy boundaries of the generated data, to see if they meet the desired data quality objectives and site characterization needs (e.g., if data can be considered accurate at 100 µg/g +/- 300%, and the cleanup standard is 500 µg/g, it may be acceptable).

In general, the following recommendations are offered:

- ◇ Techniques that detect a structural class and/or range of compounds are preferred, as opposed to methods that rely upon one specific indicator compound. Techniques that detect a range of compounds include PID/FID headspace techniques, UV absorbance/fluorescence, and emulsion-based TPH techniques. Procedures that target a single indicator compound require sufficient site-specific correlative and confirmatory data.
- ◇ Techniques that target aromatic hydrocarbons are preferred, as opposed to methods that target aliphatic compounds, due to the fact that aromatic hydrocarbons are, as a class, more toxic and mobile than aliphatic hydrocarbons. *On the whole, it is better to be able to accurately quantitate collective aromatic hydrocarbons, and estimate aliphatics, than to accurately quantitate collective aliphatic hydrocarbons, and estimate aromatics.* Techniques that target aromatics include PID headspace and UV absorbance/fluorescence.
- ◇ Techniques that involve a quick “shake out” extraction technique for soil analyses may not be sufficient for clay or organic-rich soils, due to partitioning efficiencies.

### 3.8.2 Recommended Approach

For small sites, such as residential underground storage tank (UST) excavations, screening techniques are perhaps best used to direct soil removal operations, identify areas for assessment and/or confirmatory VPH/EPH laboratory analysis, and/or provide a database to support the representativeness of decision-quality data. For larger sites, the use of screening data as a substitute and complement for VPH/EPH laboratory data may provide a better and less expensive approach to site characterization. For example, for the price of a single EPH test (approximately \$200), it may be possible to perform 4 to 10 field screening analyses. So, for a sampling and analytical budget of \$2000, it may make sense to take 8 EPH samples, and 8 to 20 field-screening samples, rather than (just) 10 EPH samples. The minimum number of VPH/EPH laboratory samples needed to understand contaminant chemistry, and provide confidence in screening data, is necessarily site-specific. The key variables are the heterogeneity of site conditions (stratigraphic/microbiological), source vs. migration areas, and the degradability of the petroleum product(s). Generalized *Rules of Thumb* in this regard are provided in Table 3-5. Note that additional confirmatory sampling would be indicated if sufficient correlation could not be established between the VPH/EPH values and screening/TPH values.

**Table 3-5: Recommended Minimum VPH/EPH Laboratory Confirmation Data Needed to Support Analytical Screening**

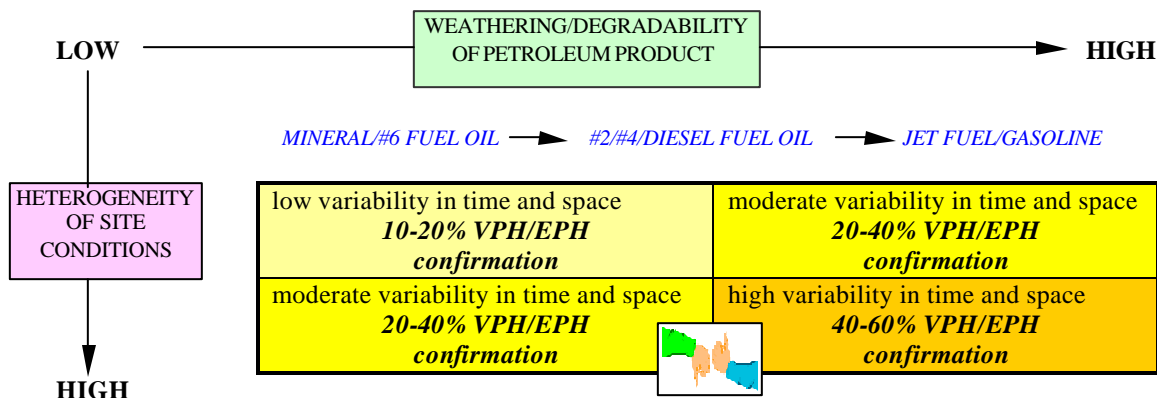

### 3.9 Drinking Water Testing Methods

When testing a potable drinking water supply, the use of the VPH/EPH analytical methods should be limited to quantitation of hydrocarbon ranges of interest; specific analytes of interest should be quantitated using the appropriate EPA “500” series drinking water methods.

## 4.0 CLEANUP STANDARDS

The Massachusetts Contingency Plan (MCP) provides three methods to assess risks and determine *how clean is clean enough*:

- ◇ Method 1 - generic cleanup standards in soil and groundwater
- ◇ Method 2 - site-specific modification of generic cleanup standards
- ◇ Method 3 - completely site-specific risk assessment

The easiest approach is Method 1, in that cleanup standards have already been established by MADEP. In support of the VPH/EPH approach, 6 generic standards have been developed and promulgated for the aliphatic and aromatic fractions of interest. A conservative TPH standard has also been retained, to allow continued use of such methods. *Note that it is not necessary to meet a TPH cleanup standard (or Reportable Concentration) if all 3 EPH fractional standards are achieved [see 310 CMR 40.0973(7) and 40.0360(2)].*

Because the Method 1 standards are generic, and were calculated assuming conservative site conditions, they can overestimate risk at some sites. In such cases, use of a Method 2 or 3 alternative approach may be advisable and cost effective. Guidance and recommendations in this regard are provided in Table 4-1.

For complete information and guidance on the use of the MCP risk assessment methods, consult the Massachusetts Contingency Plan at 310 CMR 40.0900, and MADEP’s *Guidance for Disposal Site Risk Characterization in Support of the Massachusetts Contingency Plan*, available at <http://www.state.ma.us/dep/ors/orspubs.htm>.

**Table 4-1: Choosing an MCP Risk Assessment/Cleanup Method**

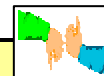

Method	Consider Using If.....	Significant Limitations
1	<ul style="list-style-type: none"> <li>◆ simple/small site</li> <li>◆ contamination in soil and gw only</li> <li>◆ cleanup to Method 1 standards is feasible</li> </ul>	<ul style="list-style-type: none"> <li>◇ cannot be (solely) used if sign. sediment contam</li> <li>◇ cannot be (solely) used if sign. indoor air impacts [see 40.0942]</li> </ul>
2	<ul style="list-style-type: none"> <li>◆ groundwater concentrations &gt; GW-2 standards</li> <li>◆ groundwater concentrations &gt; GW-3 standards</li> <li>◆ sites in GW -1 areas and C9-C10 or C11-C22 Aromatic fraction(s) in soil &gt; Method 1 stds</li> </ul>	<ul style="list-style-type: none"> <li>◇ can't use if sign. sediment contamination</li> <li>◇ can't use if sign. indoor air impacts [see 40.0942]</li> </ul>
3	<ul style="list-style-type: none"> <li>◆ complex/large sites</li> <li>◆ sites with indoor air impacts</li> <li>◆ sites with sediment contamination</li> <li>◆ sites with soil/gw &gt; Method 1 standards</li> </ul>	<ul style="list-style-type: none"> <li>◇ can't achieve permanent solution if: (1) more than 0.5 inches NAPL, or (2) above drinking water std in GW-1 area; or (3) soil conc above Upper Conc Limits (UCLs) unless deeper than 15' or below engineered barrier; or (4) gw conc &gt; UCL</li> </ul>

## 4.1 Exposure Point Concentrations

Regardless of the risk assessment method selected, it is necessary to calculate Exposure Point Concentrations in media and pathways of interest.

### 4.1.1 Groundwater EPCs

In accordance with the provisions of 310 CMR 40.0924(2)(a)(1.), when using a Method 1 or 2 Risk Characterization approach, EACH well and/or groundwater monitoring point is a separate Exposure Point, and data from each well is considered a separate Exposure Point Concentration. Accordingly, the (temporal) average concentration of dissolved analytes in EACH monitoring well cannot exceed appropriate GW -1, GW-2, and/or GW-3 standards (i.e., spatial averaging of data among wells is not permitted). More flexibility is allowed in a Method 3 risk assessment, with the exception of GW-1 areas [40.0924(2)(b)(2.)].

Because groundwater is a dynamic medium, a single “snapshot in time” is generally not sufficient to characterize contaminant levels, and calculate Exposure Point Calculations. ***Except for petroleum products with a low water soluble fraction, it is generally not possible to adequately characterize groundwater quality on the basis of a single round of sampling.*** Seasonal and antecedent precipitation events can significantly influence groundwater quality in any given well on any given day. Over the course of a year, temporal fluctuations in the concentration of dissolved analytes in monitoring wells can be substantial; variation by factors of 2-3 are common at most sites, and factors of up to 5-10 are possible, especially for water table wells, and when monitoring low levels of analytes (i.e., < 50 µg/L).

The amount of spatial and temporal monitoring data needed to make reasonable and meaningful conclusions on groundwater quality is necessarily a site-specific decision, based upon (1) the type/water-solubility of the petroleum product(s) released, (2) the homogeneity of the formation, (3) the sensitivity of potential pollutant receptors, (4) the magnitude of contaminant concentrations (with respect to the standard(s) of interest), and (5) the degree of confidence and understanding of the Conceptual Site Model.

Table 4-2 provides the minimum recommended number of rounds of groundwater sampling at petroleum-contaminated sites where NAPL is not present. A preferred approach is to obtain at least 4 measurements over a 1-year period, coinciding with seasonal variations. **In cases where less than 1 year of quarterly monitoring has been performed, it is necessary to consider and address expected variations in analyte concentrations over time (especially in cases where limited sample data is just below the applicable standard).**

**Table 4-2 Minimum Recommended Quarterly Rounds of Groundwater Monitoring at Sites Where NAPL is Not Present**

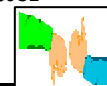

Location/GW Category	Gasoline/ JP-4	Diesel/#2-4 Fuel/Kerosene	Mineral/Lube/#6 Fuel Oil
< 800 feet from water supply	4+	3-4	2-3
GW -2	2-3	2	1
GW -3	1-2	1-2	1

It is important to stress that the recommendations provided above are for *quarterly* sampling efforts, with each quarter comprising a 3-month time period coinciding with spring, summer, fall, and/or winter conditions. Multiple sampling rounds in any given season, while providing potentially useful site data, cannot be considered equivalent to multiple samples over multiple seasonal conditions.

Beyond the general concerns and recommendations provided above for all sites, additional monitoring efforts are necessary at sites where groundwater remediation has been undertaken, to determine if contaminant “rebound” has occurred (i.e., a significant increase in dissolved groundwater contaminant concentrations that occurs as contaminants partition and diffuse from and near soil solids). In such cases, groundwater monitoring should be systematically conducted for at least 6 - 9 months after the termination of all remedial activities.

#### **4.1.2 Soil EPCs**

A general discussion of issues and recommendations for the development and calculation of soil Exposure Point Concentrations (EPCs) is contained in *Guidance for Disposal Site Risk Characterization in Support of the Massachusetts Contingency Plan*. Of particular interest at petroleum-contaminated sites is the evaluation of subsurface soil contamination associated with releases from Underground Storage Tanks (USTs). In this regard, when obtaining soil samples at an UST grave for the purposes of determining an EPC, it is necessary to specifically investigate whether a “hot spot” exists within the groundwater table fluctuation zone (i.e., the “smear zone”). For gasoline and fresh diesel/fuel oil releases, this action may be easily accomplished by headspace analysis of samples from sidewall excavations using a PID meter. In cases where headspace concentrations within this smear zone are equal to or greater than 10 times other locations on the sidewall, soil samples from this zone should be discretely collected/composited (either as the sidewall sample or with other sidewall samples) for appropriate analyses.

#### **4.1.3 Indoor Air EPCs**

Extensive guidance on this subject is provided in the *MADEP Indoor Air Sampling and Evaluation Guide*, available at <http://www.state.ma.us/dep/ors/files/indair.pdf>. When evaluating indoor air impacts at disposal sites, however, it is important to understand and differentiate sampling and evaluation objectives and requirements.

Specifically, when the objective is to calculate indoor air EPCs for the purpose of conducting a quantitative risk assessment, temporal and/or spatial averaging of data may be appropriate. Conversely, when the objective is to determine whether a Critical Exposure Pathway (CEP) is present at a home or school, averaging of this nature is NOT appropriate; rather, data from “worse case” site conditions are of interest. Additional discussions in this regard are provided in Section 4.3.

## **4.2 Method 1 Cleanup Standards**

Generic soil and groundwater cleanup standards have been developed by MADEP for the 3 hydrocarbon fractions detected using the VPH analytical procedure (i.e., C5-C8 Aliphatics, C9-C12 Aliphatics, and C9-C10 Aromatics) and the 3 hydrocarbon fractions detected using the EPH analytical procedure (i.e., C9-C18 Aliphatics, C19-C36 Aliphatics, and C11-C22 Aromatics). These standards are designed to be protective at most sites, and were developed using a series of conservative site scenarios to evaluate risks to human health, public welfare, and the environment via a number of exposure pathways and concerns, including direct contact, ingestion, leaching (soil), and volatilization (groundwater).



Method 1 cleanup standards have been developed for 3 categories of groundwater (see 310 CMR 40.0932):

- ◇ **GW-1 Standards** - applicable in (GW -1) areas where groundwater is or may be used for drinking water purposes. The GW -1 standards are based upon ingestion/use of groundwater as a potable water supply.
- ◇ **GW-2 Standards** - applicable in areas within 30 feet of an occupied structure if the depth to groundwater is less than 15 feet from the ground surface. GW -2 standards are based upon inhalation exposures that could occur to occupants of a building impacted by volatile compounds which partition from shallow groundwater.
- ◇ **GW-3 Standards** - applicable at all sites. GW -3 standards consider impacts to aquatic receptors in surface water bodies that receive recharge from a contaminated groundwater plume.

Based upon the above, it can be seen that any given disposal site may fall in one, two, or all three categories. At sites where more than one category applies, groundwater contaminants must be at or below all applicable GW standards in all applicable categories in order to demonstrate a condition of “No Significant Risk” per Method 1.

Method 1 cleanup standards have also been developed for 3 categories of soil (see 310 CMR 40.0933):

- ◇ **S-1 Standards** - applicable to soils that are accessible or potentially accessible, and where the frequency and/or intensity of exposure is high.
- ◇ **S-2 Standards** - applicable to less accessible soils, with lower exposure potential.
- ◇ **S-3 Standards** - applicable to isolated soils, and/or soils where the frequency and/or intensity of exposure is low.

Because all soil standards consider leaching impacts to underlying groundwater, and because there are 3 groundwater categories, there is a matrix of nine possible Method 1 soil standards for each contaminant (e.g., S-1/GW -1, S-1/GW -2, etc.). As with the GW standards, any given disposal site may fall in one or more of these nine soil standards. At sites where more than one category applies, soil contaminants must be at or below all applicable “S-x/GW-y” standards in all applicable categories in order to demonstrate a condition of “No Significant Risk” per Method 1.

In addition to the human health and environmental exposures described above, all Method 1 standards are bounded by certain *basement* and *ceiling* conditions established by MADEP. As a lower limit, no Method 1 standard is set below a background or analytical reporting limit, even if the risk-based concentration was less than this value. On the other extreme, no Method 1 standard is set above a series of “ceiling” concentrations established for classes of soil and groundwater contaminants. Ceiling levels were established to account for exposure pathways and factors that were not considered in developing these generic standards, including “public welfare” concerns related to odors. The ceiling level in groundwater is set at 50,000 µg/L; the ceiling levels in soil are 100, 500, 1000, 2500, and 5000 µg/g, depending upon the soil category (i.e., S-1, S-2, or S-3) and the vapor pressure and/or Odor Index of the compound or hydrocarbon range of interest. Additional information on ceiling levels and Method 1 standards are provided in the MADEP publication *Background Documentation for the Development of the MCP Numerical Standards*, April 1994, and as amended, which is available and may be downloaded from <http://www.state.ma.us/dep/ors/orspubs.htm>

#### **4.2.1 Using Method 1 VPH/EPH Fractional Standards**

Using Method 1 to characterize a petroleum release is a two step process:

- Step 1 - identify and evaluate individual Target Analytes of interest, to address specific hydrocarbon constituents of concern, including carcinogenic compounds; and
- Step 2 - identify and evaluate aliphatic/aromatic fractions of interest, to address the rest of the hydrocarbon mixture.

*Note: When using Method 1 fractional standards, it is necessary to have some actual (VPH/EPH) fractional range data. Although it is possible to make assumptions on the aliphatic/aromatic breakdown of TPH and GRO data, and demonstrate compliance with cleanup standards without any VPH/EPH data, such actions must be undertaken as part of a Method 3 Risk Characterization process. Alternatively, TPH data may continue to be compared directly to Method 1 TPH standards, at sites contaminated by heavier petroleum products.*

## 4.2.2 Target Analytes

Target Analytes are those constituents of petroleum which have traditionally been used to characterize environmental pollution, and for which MADEP has specific Method 1 cleanup standards: benzene, toluene, ethylbenzene, xylenes, MtBE, lead, Ethylene Dibromide, and the 17 “priority pollutant” PAHs. *By definition, Target Analytes are not counted within the VPH and EPH Aliphatic and Aromatic hydrocarbon fractions.*

It is not necessary to test all media and all petroleum releases for all Target Analytes; this decision is site-specific, based upon (1) the type (chemistry) of the petroleum product(s) released, (2) fate and transport considerations, and (3) the sensitivity of area receptors. Guidance and *Rules of Thumb* on the most commonly released petroleum products, based upon Total Organic Vapor (TOV) headspace screening and/or TPH data, are provided in Table 4-3.

**Table 4-3: Recommended Target Analyte List for Petroleum Products**

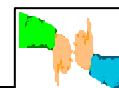

Petroleum Product	Media	Headspace TOV	TPH	Recommended Target Analytes
Gasoline	soil	-----	-----	benzene, toluene, ethylbenzene, xylenes (BTEX), naphthalene, and appropriate additives (e.g., MtBE, lead, and/or EDB).
	gw	-----	-----	benzene, toluene, ethylbenzene, xylenes (BTEX), naphthalene, and appropriate additives (e.g., MtBE, lead, and/or EDB).
#2 Fuel/Diesel	soil	≥100 ppmv	-----	benzene, toluene, ethylbenzene, xylenes, naphthalene
		-----	>500 µg/g	acenaphthene, naphthalene, 2-methylnaphthalene, phenanthrene
	gw	-----	-----	acenaphthene, naphthalene, 2-methylnaphthalene, phenanthrene; in GW -1, test also for BTEX, MtBE <sup>1</sup>
#3-#6 Fuel Jet Fuels	soil	≥100 ppmv	-----	benzene, toluene, ethylbenzene, xylenes, naphthalene
		-----	-----	17 priority pollutant PAHs, unless justification not to
Kerosene	gw	-----	-----	If in GW -1 area, test for BTEX and 17 priority pollutant PAHs
Lube Oils Hydraulic Oils		-----	-----	
Waste Oils	soil	≥ 10 ppmv	-----	BTEX/VOCs, PAHs, PCBs, heavy metals
		-----	-----	PAHs, PCBs, heavy metals
	gw	-----	-----	BTEX/VOCs, PAHs, PCBs, heavy metals

<sup>1</sup>While MtBE is not an additive in fuel oils, it may become present during the transport and distribution process due to mixing of residue product

### 4.2.2.1 Petroleum Product Additives

The topic of petroleum product additives warrants special consideration with respect to the selection of Target Analytes.

Since 1923, organic, inorganic, and/or organo-metallic compounds have been added to petroleum products to enhance performance characteristics or address operational or air pollution concerns. While additives of this nature have been numerous – and often proprietary – the list of common additives with significant environmental concerns is relatively small. Details in this regard are presented in Table 4-4.

**Table 4-4: Common Gasoline Additives (Massachusetts)**

Additive	Purpose	Amount Added	Peak Years	Analytical Methods (soil/groundwater)
alkyl leads (tetraethyl lead; tetramethyl lead)	anti-knock/octane enhancer	1-2.5 grams/gal	1923-1981 (automotive gasoline)	Total Pb via ICP-AES (EPA 6010B) or AAS (EPA 7000); alkyl Pb by California LUFT/DHS or other proced.
		2-4 grams/gal	1920s-present (aviation gasoline)	
Ethylene Dibromide (EDB)	“scavenger” in leaded gasoline	variable	1923-1981 (cont use in aviation gasoline)	EPA Method 8260B or EPA Method 8021B
MtBE	octane enhancer	1-8% by volume	1979-1991	MADEP VPH; EPA Method 8260B <sup>a</sup>
	oxygenate	10-15 % by volume	1991-present	MADEP VPH; EPA Method 8260B <sup>a</sup>

<sup>a</sup> acidification of aqueous samples can lead to significant breakdown of MtBE

**4.2.2.2 Petroleum Product Additives as Target Analytes**

*Rules of Thumb* on the selection and analysis of specific petroleum product additives as Target Analytes are provided below:

- Given its history of use as an octane enhancer and oxygenate in New England, *MtBE* should always be considered a soil and groundwater Target Analyte of concern (all soil and groundwater categories) at disposal sites where a release of unleaded gasoline occurred or likely occurred after 1979.
- In addition to unleaded gasoline, *MtBE* should also be considered a groundwater Target Analyte of concern within the GW -1 areas of disposal sites where a release of #2 fuel/diesel oil occurred or likely occurred after 1979. Although not (purposely) added to these products, it is believed that trace levels of MtBE are introduced into stocks of #2 fuel/diesel oil during the storage and transportation process. Recent studies have identified the presence of low to moderate concentrations of MtBE within the groundwater at sites contaminated (solely) by a release of #2 fuel/diesel oil.
- Lead* and *Ethylene Dibromide* should be considered groundwater Target Analytes of concern within the GW -1 areas of disposal sites where a release of gasoline occurred or likely occurred prior to 1988. In addition, *Lead* should be considered a soil Target Analyte of concern within the S-1 areas of disposal sites where a release of leaded gasoline occurred or likely occurred prior to 1988. Because alkyl lead complexes are expected to break down into inorganic salts within a 15-year timeframe, use of a “total lead” methodology (e.g., AA/ ICP) is generally appropriate and sufficient in such cases.
- Lead* and *Ethylene Dibromide* should be considered soil and groundwater Target Analytes of concern (all soil/groundwater categories) at disposal sites where a release of leaded gasoline occurred or likely occurred after 1987. Due to their toxicities, it may be necessary to use analytical methods capable of detecting and quantitating the specific alkyl lead compounds of concern (e.g., tetraethyl lead). Although there are few published methods for alkyl lead analysis, one procedure is provided in the California LUFT Manual (<http://www.swrcb.ca.gov/general/publications/docs/luft-manual-1989.pdf>)



A summary of the above recommendations is provided in Table 4-5.

**4.2.2.3 Ethanol**

Because of its persistence and mobility in the environment, which has lead to wide-scale groundwater contamination, the use of MtBE as a gasoline additive will likely be reduced or eliminated in the coming years. The most likely replacement for MtBE is ethanol, which is already a widely used oxygenate in

**Table 4-5: Recommended Target Analyte List for Petroleum Additives**

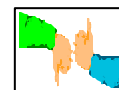

Petroleum Product Released at Site	Date of Release	Recommended Target Analyte(s)	Soil Category			Groundwater Category		
			S-1	S-2	S-3	GW-1	GW-2	GW-3
Unleaded Gasoline	≥1979	MtBE	✓	✓	✓	✓	✓	✓
#2 Fuel/Diesel Oil	≥1979	MtBE <sup>1</sup>				✓		
Leaded Gasoline	≤1987	Total Lead	✓			✓		
		EDB				✓		
Leaded Gasoline	>1987	Lead/alkyl leads	✓	✓	✓	✓		✓
		EDB	✓	✓	✓	✓	✓	✓

<sup>1</sup>While MtBE is not an additive in fuel oils, it may become present during the transport and distribution process due to mixing of residue product

certain parts of the United States, and, in fact, has already been identified at some gasoline release sites in Massachusetts. To date, MADEP has not established a Method 1 standard for ethanol, though it is considered a “hazardous material” under the MCP (see 310 CMR 40.1600). Until such time as the use of ethanol becomes more widespread in Massachusetts, it is not necessary to routinely test for this additive at disposal sites, except as noted below:

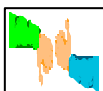

- In cases where ethanol is *known* to have been present in gasoline released at a disposal site (e.g., based upon information provided by a service station owner), sampling and analysis for ethanol should be *considered*, based upon the nature of site conditions and sensitivity of surrounding receptors;
- In cases where a release of gasoline has contaminated a drinking water supply, and where ethanol is *known* or *suspected* to be present in the gasoline released at the site (e.g., lack of MtBE contamination), a sample of the drinking water should be analyzed for ethanol.

Note that while ethanol is believed to be less toxic than MtBE, and, unlike MtBE, readily biodegradable under both aerobic and anaerobic conditions, elevated concentrations in the environment may result in certain adverse impacts:

- Due to cosolvency effects, the presence of high concentrations of ethanol may lead to increased levels of gasoline constituents in groundwater, including the Target Analytes benzene, toluene, ethylbenzene, and xylenes (BTEX).
- Because of its highly biodegradable nature, ethanol exerts a high biochemical oxygen demand that can quickly deplete oxygen (and nutrient) levels in the area of contamination, which may lead to longer plumes of BTEX and other dissolved gasoline hydrocarbons. This phenomenon has implications to natural attenuation considerations, and bearing on the design of enhanced and engineered bioremediation systems at such sites.

#### 4.2.2.4 Additional Petroleum Additives

In general, beyond the recommendations contained above, it is not necessary to routinely test for additional petroleum product additives at disposal sites. At disposal sites where releases of gasoline or diesel fuel have impacted drinking water supplies, however, samples of the impacted drinking water should be analyzed (a) by EPA Method 8260B for all method analytes and for Tentatively Identified Compounds (TICs), and (b) for the metals listed in Method EPA 6010B, excluding the common “background” elements calcium, iron, manganese, and sodium. Such an action is appropriate given (i) the wide variety of chemical additives in

petroleum products, (ii) the relative mobility of volatile organic compounds and certain metal salts and complexes, and (iii) the sensitivity of the exposure pathway.

#### 4.2.3 Hydrocarbon Fractions of Interest

It is not necessary to test all media and all petroleum releases for all 6 VPH/EPH hydrocarbon fractions; this decision is also site-specific, based upon (1) the type (chemistry) of the petroleum product(s) released, (2) fate and transport considerations, and (3) the sensitivity of area receptors. Guidance and *Rules of Thumb* on ranges of interest, as determined by either the VPH or EPH test method, are provided in Table 4-6 for the most commonly released petroleum products.

*When using a Method 1 approach, each VPH/EPH fraction is treated as if it were a single entity or unique chemical. The general rules that apply to Method 1 Risk Characterization, such as averaging data and hot spot determinations, also apply to these aliphatic and aromatic fractions.*

**Table 4-6: Hydrocarbon Fractions of Interest**

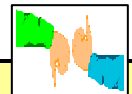

Petro Product	Media	VPH	EPH	Comments/Caveats
Gasoline	soil	✓		
	gw	✓		
Fresh	soil	✓	✓	“Fresh” is defined as soil/gw with TOV headspace $\geq$ 100 ppmv
Diesel/#2 Fuel	gw	✓	✓	
Weathered	soil		✓	“Weathered” defined as soil/gw with TOV headspace $<$ 100 ppmv
	gw		✓	VPH testing recommended if potentially/impacting a water supply
#3-#6 Fuel Oil	soil		✓	
Hydraulic Oil	gw		✓	VPH testing recommended if potentially/impacting a water supply
Mineral/Di-electric Fluids	soil		✓	
	gw		✓	VPH testing recommended if potentially/impacting a water supply
Jet Fuel JP-4	soil	✓	✓	May eliminate/reduce VPH testing if TOV headspace $<$ 100 ppmv
JP-8	gw	✓	✓	
Jet Fuel Jet A /	soil		✓	
Kerosene	gw		✓	VPH testing recommended if potentially/impacting a water supply
Waste	soil	✓	✓	May eliminate/reduce VPH testing if TOV headspace $<$ 10 ppmv
Crankcase Oil	gw	✓	✓	
Unknown Oils	soil	✓	✓	May eliminate/reduce VPH testing if TOV headspace $<$ 10 ppmv
	gw	✓	✓	

For samples analyzed by both the VPH and EPH test procedure, there are two methodological issues that warrant discussion and clarification:

- ◇ When a (split) sample is analyzed by both the VPH and EPH methods, it is not necessary to quantitate or address a (VPH) value for C9-C12 Aliphatic Hydrocarbons, as these hydrocarbons are included within the C9-C18 Aliphatic Hydrocarbon range detected by the EPH test method. Note that there may be cases where the C9-C12 Aliphatic concentration via the VPH test method exceeds the C9-C18 Aliphatic concentration quantitated by the EPH method – this dichotomy occurs because the VPH method tends to over-quantitate aliphatics in this range (because the FID is also quantitating aromatic compounds). In general, the EPH method should provide more accurate data for this range.

- ◇ In cases where Target Analytes are quantitated by both the VPH and EPH methods, naphthalene will be reported by both procedures. Because it is within the dividing region between purgeable and extractable organics, naphthalene is a problem analyte in both methods: it's the heaviest VPH compound, and difficult to purge, while at the same time being the lightest EPH compound, and therefore subject to volatilization losses during the EPH extraction process. *Accordingly, in such cases, the highest reported value should be used.*

#### **4.2.4 Limitations on the Use of Method 1 Cleanup Standards**

Because of the generic assumptions used in the development of the Method 1 standards, they are not appropriate, and cannot be (solely) used at all sites. The most significant limitations in this regard for VPH/EPH standards are:

- ◆ there must be a Method 1 standard for all Contaminants of Concern (including any non-petroleum contaminants); and
- ◆ the contamination must be limited to just soil and groundwater, and cannot be present in sediments, air, or surface water.

##### **4.2.4.1 Hydrocarbons**

With respect to Contaminants of Concern, if only petroleum products are present at a site, there should be no limitations on the use of the Method 1 standards, as the collective VPH and EPH fractional ranges should address all detected constituents. Note that these collective range standards eliminate problems that arose in the past when laboratories using a GC/MS technique would report petroleum constituents, such as trimethylbenzenes, which did not have a Method 1 Standard - and which therefore called into question the applicability of Method 1. It also follows that this practice of identifying additional petroleum (non-target) analytes is no longer necessary, as long as the compound in question is a petroleum constituent that is collectively quantitated in a hydrocarbon range of interest (e.g., the trimethylbenzenes are picked up in the C9-C10 Aromatic Hydrocarbon range detected by the VPH test method).

##### **4.2.4.2 Additives**

At present, Method 1 standards exist only for lead and MtBE. If other additives are identified at a disposal site, it will be necessary to evaluate risks using a Method 2 or Method 3 risk assessment process.

##### **4.2.4.3 Air-Phase Contamination**

With respect to contamination present in a medium other than soil or groundwater, the most common and problematic limitation occurs when hydrocarbon contaminants are present in the ambient or indoor air at a site. Since this exposure was NOT considered in the development of the Method 1 cleanup standards, a Method 3 assessment must be conducted in such cases.

Volatile non-aqueous phase liquids (NAPL), including separate-phase gasoline, kerosene, jet fuels, and fresh diesel/#2 fuel oils, can result in the generation of significant concentrations of volatile petroleum hydrocarbon vapors in the vadose zone, which can potentially impact the indoor air of nearby structures. Purging a monitoring well containing such NAPL prior to obtaining a groundwater sample may underestimate risks of this nature, as the groundwater sample may contain relatively low concentrations of dissolved hydrocarbons. *For this reason, soil gas investigations should be considered at any site at which volatile NAPL has been identified in monitoring wells or test pits, to characterize the risks posed to indoor air quality, and determine whether use of a Method 1 approach is appropriate.*

#### **4.2.5 Odors**

Odors are an indication that hydrocarbon compounds are present in another medium (air) beyond soil or groundwater (although a lack of odors does not mean that hydrocarbon compounds are not present). Such odors could constitute a significant risk to human health, and/or a nuisance condition that may be considered a significant risk to public welfare.

For this reason, Method 1 cleanup standards should not be used at sites with the following odor conditions:

- ◇ persistent, long term (>3 months) odors in the ambient air at a disposal site; or
- ◇ persistent, long term (>3 months) odors in the indoor air of a building impacted by a disposal site.

***Short term, ephemeral odors, and/or odors noted at depth during subsurface excavation or exploration, would not, by themselves, invalidate the use of a Method 1 approach.***

A tabulation of Method 1 Cleanup Standards for the VPH/EPH hydrocarbon fractions, and TPH, is provided in Appendix 4. Note that these values are current as of the date of this publication, but are subject to change. For a current list of cleanup standards (and Reportable Concentrations), consult the most current version of the Massachusetts Contingency Plan.

### 4.3 Method 2 Risk Characterization

Using Method 2, site-specific fate and transport factors and considerations may be used to modify certain Method 1 standards. The Method 1 standards that are most likely to be exceeded at petroleum contaminated sites, and for which a Method 2 approach may be advisable, are listed in Table 4-7.

**Table 4-7: Method 1 Standards Most Likely to be Exceeded**

Contaminant	Groundwater		Soil (standards based upon leaching)		
	GW-2 (µg/L)	GW-3 (µg/L)	S-1/GW-1 (µg/g)	S-2/GW-1 (µg/g)	S-3/GW-1 (µg/g)
C5-C8 Aliphatics (VPH)	✓	✓			
C9-C12 Aliphatics (VPH)	✓				
C9-C10 Aromatics (VPH)	✓	✓	✓	✓	✓
C9-C18 Aliphatics (EPH)	✓				
C11-C22 Aromatics (EPH)		✓	✓	✓	✓
benzene			✓	✓	✓
2-Methylnaphthalene			✓	✓	✓
naphthalene			✓	✓	✓

A summary of recommended Method 2 assessment approaches and limitations is provided in Table 4-8.

**Table 4-8: Use of Method 2 at Petroleum-Contaminated Sites**

Site Condition	Method 2 Assessment Actions	Limitations
groundwater concentration > GW -2 Std	Evaluate potential for dissolved hydrocarbons in groundwater to impact indoor air of adjacent structures	Assessment limited to demonstration of “no impacts” to structure, based upon actual field data
groundwater concentration > GW -3 Std	Evaluate potential for dissolved hydrocarbons in groundwater to impact receiving surface water body	Cannot modify to exceed an Upper Concentration Limit or have $\geq 0.5$ inches NAPL
soil concentration > Soil Standard	Evaluate potential for hydrocarbons to leach from soil and impact underlying groundwater	Cannot modify to exceed an appropriate “direct contact” soil-exposure concentration [40.0985(6)]

Two important limitations to a Method 2 approach at petroleum-contaminated sites warrant additional emphasis:

- \* Method 2 may **NOT** be used to modify an applicable Method 1 GW -1 standard, including the VPH/EPH fractional standards; and

- \* Fate and transport models may **NOT** be (solely) used to evaluate or “rule out” an impact to indoor air from dissolved concentrations of the VPH/EPH fractions in groundwater. This prohibition is due to the fact that the GW - 2 standards for the VPH/EPH fractions were not directly calculated from a modeling exercise, because of a lack of relevant fate/transport and toxicological information. Thus, because there are no generic modeling assumptions for these fractions, there are no direct site-specific modeling modifications possible via a Method 2 approach.

### 4.3.1 Using a Method 2 Approach to Demonstrate “No Impact” to Indoor Air

At sites where a Method 1 GW -2 standard is exceeded for a VPH/EPH fraction and/or Target Analyte, a multi-level, progressively structured investigatory program is recommended, to obtain sufficient information and data to determine whether an impact to indoor air has occurred or is likely to occur. This same approach may be used to investigate concerns over the presence of contaminated soils in close proximity to a building. At some sites, conclusions in this regard are relatively clear; at others, a “tool-box” approach may be needed to establish lines of evidence to make such a determination. In most cases, an optimal and cost-effective tool-box approach is to proceed along a continuum of low-cost/conservative-efforts toward higher-cost/more-accurate-techniques, using the cumulative totality of information to rule out impacts as “unlikely”, or, when such a decision cannot be supported, arrive at a conclusion that such impacts are in fact likely. This process is illustrated in Figure 4-1.

**Figure 4-1: Evaluating Indoor Air Pathway via Method 2**

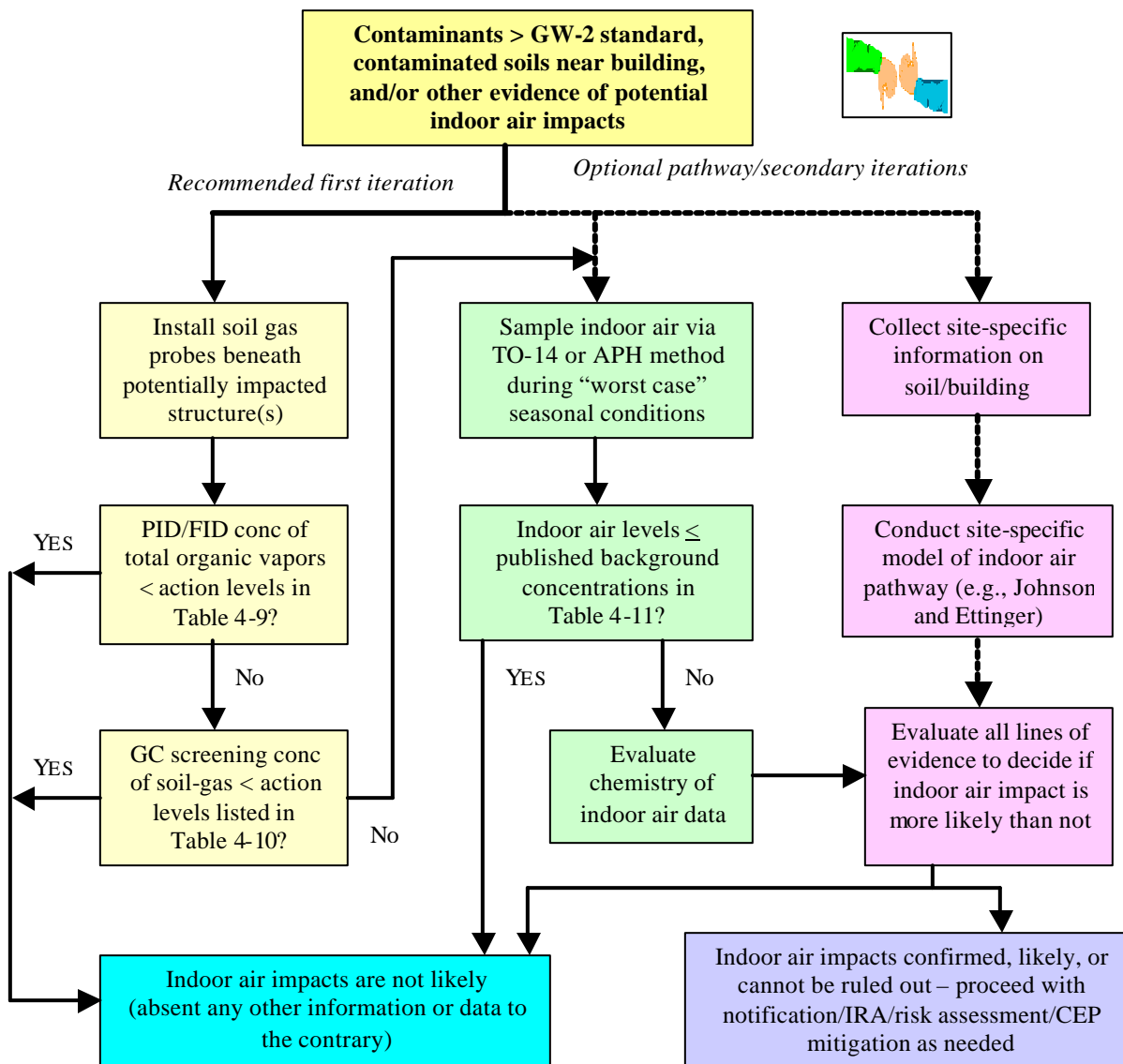



Initially, a relatively inexpensive soil gas screening effort is recommended, utilizing a series of conservative assumptions, in an attempt to rule out exposure/pathway concerns. Sites not screened out at this stage should consider increasingly more sophisticated and invasive actions, up to and including sampling and analysis of indoor air. Step-by-step recommendations are provided below. Additional guidance may be obtained from the *MADEP Indoor Air Sampling and Evaluation Guide*.

#### 4.3.1.1 Level 1 - Soil Gas Screening

- a) Install at least one or two soil gas sampling probes beneath the structure of concern (e.g., through the concrete slab of a basement floor). For larger structures, additional probes may be needed. If probes cannot be installed within the footprint of the structure, install soil gas sampling probes along the perimeter of the building, as close as possible to the structure. Locations beneath pavement or other impervious surfaces are preferred to obtain representative conditions.

**Soil gas probes located in unpaved areas and/or other areas where rain/snowmelt/surface water infiltration is occurring may not yield representative data. Data from such locations may be biased low, due to displacement and/or solubilization of soil gas vapors during an infiltrative event.**

- b) Install and sample probes placed within the footprint of the structure in a manner that enables the collection of a soil gas sample from just beneath the lowest (floor/slab) elevation. Probes outside of the footprint of the building should be installed and sampled in a manner that enables the collection of a soil gas sample from a point just below the lowest (floor/slab) elevation.
- c) Withdraw a sample of soil gas from each probe, for analysis by a Photoionization Detector (PID) and/or Flame Ionization Detector (FID) meter. The PID should be calibrated to an isobutylene response, the FID to a methane response. Continuous, real-time measurements may be made, or a sample can be pumped to a Tedlar (or equivalent) bag for subsequent PID/FID analyses. Unless a demonstration is made that the sampling technique and equipment is capable of delivering a soil gas sample to the PID/FID meter at an adequate pressure and flow rate, use of the bag technique is recommended. Additional guidance is provided in MADEP's *Policy for the Investigation, Assessment, and Remediation of Petroleum Releases*, April, 1991 (DEP Publication #WSC-401-91), available at <http://www.state.ma.us/dep/bwsc/finalpol.htm>
- D) Compare the readings obtained on the PID and/or FID meters with the screening values in Table 4-9.

**Table 4-9: Soil Gas PID/FID Screening Levels for Evaluating Indoor Air Impacts**

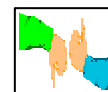

Hydrocarbon Fraction(s) and Target Analytes which exceed applicable Method 1 GW-2 Standards and/or are present in proximate soils	Indoor air impacts unlikely if below listed value for each hydrocarbon fraction & Target Analyte of interest			
	PID ppmV (Isobutylene response)			FID ppmV (methane response)
	< 10.1 eV	10.1 – 11.4 eV	>11.4 eV	
C5-C8 Aliphatic Hydrocarbons	N/A	7	29	25
C9-C12 Aliphatic Hydrocarbons	3	7	33	19
C9-C10 Aromatic Hydrocarbons	28	29	37	21
C9-C18 Aliphatic Hydrocarbons	3	7	33	19
Toluene	11	12	12	10
Ethylbenzene	4	4	4	3
Total Xylenes	25	26	24	22

- On the left side of the table, identify EACH hydrocarbon fraction(s) and/or Target Analyte(s) which exceed an applicable GW-2 groundwater standard and/or are otherwise of concern.
- If a Photoionization Detector (PID) unit was used to analyze the soil gas, identify the energy level of the (UV) lamp in electron-volts (eV). Identify the ppmV reading listed in the appropriate column, and compare this value to the site value for EACH hydrocarbon range and/or analyte of interest. If EACH site value is less than the listed value for the hydrocarbon range(s) and Target Analyte(s) of interest, impacts to indoor air are not likely.
 

*Example: BTEX and aliphatic/aromatic fractions present at site, but GW-2 standards exceeded for only Toluene and C9-C10 Aromatic Hydrocarbons. Soil gas below structure is found to have 25 ppmV (isobutylene calibration) total VOCs via a 10.6 eV PID unit. While this PID reading indicates impacts from C9-C10 Aromatic Hydrocarbons are unlikely (since < 29 ppmV), this data cannot rule out impacts by Toluene (since 25 ppmV > 12 ppmV).*
- If a Flame Ionization Detector (FID) unit was used to sample the soil gas, compare the site value to the value listed in the table. If the site value is less than the listed value for each hydrocarbon range and/or Target Analyte of interest, impacts to indoor air are not likely.
- In situations where soil gas data are available from both a PID and FID, the FID data should be the basis of this evaluation.
- In situations where soil gas data are available from PID units with different lamp (eV) intensities, the data from the highest intensity lamp should be the basis of this evaluation.

The values provided in Table 4-9 are based upon conservative assumptions on (a) likely partitioning and dilution and attenuation factors for the identified hydrocarbon compounds and ranges, (b) response characteristics of commonly available PID and FID units; and (c) empirical observations, experience, and professional judgment. Because of its toxicity and low rate of anaerobic biodegradation, screening values have not been provided for benzene. This table should not be used to rule out impacts for non-listed contaminants, or to rule out impacts at structures with earthen floors, standing water, or open floor sumps.

#### 4.3.1.2 Level 2 - Soil Gas Analysis

If indoor air impacts cannot be ruled out by PID/FID screening, more sophisticated testing is recommended for a soil gas sample obtained in accordance with the recommendations provided in Section 4.3.1.1. Recommendations in this regard follow:

##### GC SCREENING

Soil gas samples obtained in a bag, canister, or directly into a gas-tight syringe are analyzed using a GC equipped with a flame ionization detector (FID). In cases where only aromatic contaminants are of interest (i.e., G<sub>9</sub>-C<sub>10</sub> Aromatic Hydrocarbons, toluene, ethylbenzene, and/or xylenes), a GC/PID may be used in lieu of a GC/FID. Even where only aliphatic hydrocarbons are of interest, the use of a PID in series with an FID will lead to more accurate and less conservative data.

A GC/FID sample chromatogram of a fresh gasoline sample is presented in Figure 4-2.

Under this approach, a series of assumptions are used to estimate the concentration of the hydrocarbon range(s) of interest; the more sophistication employed in this effort (i.e., use of GC/PID/FID), the less conservative the assumptions:

*C5-C8 Aliphatic Hydrocarbons:* On a GC/FID, quantitate all peak elutions between n-pentane and just before n-nonane using a response factor from one or several of the normal alkanes which elute in this range (e.g., n-heptane, n-octane).

**Figure 4-2: GC/FID Soil Gas Chromatogram**

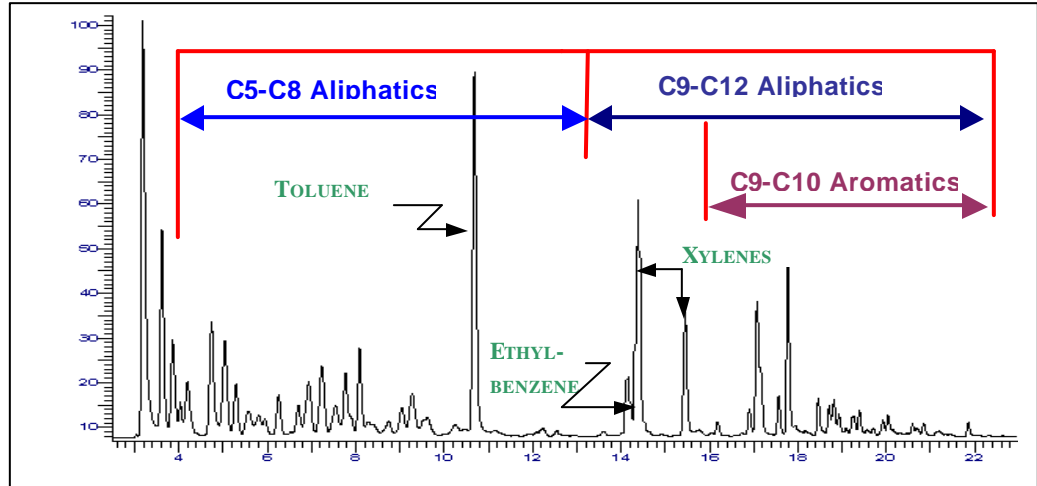

Conservatively assume that this entire concentration value is C5-C8 Aliphatic Hydrocarbons (even though MtBE and some or all of the BTEX compounds also elute in this range). Compare this value (in  $\mu\text{g}/\text{m}^3$ ) with the value listed in Table 4-10. If less than the listed value, measurable indoor air impacts are not likely. If more than this value, consider use of a GC/PID to quantitate MtBE, benzene, toluene, ethylbenzene, xylenes (BTEX), and naphthalene, and “adjust” the C5-C8 Aliphatic Hydrocarbon value previously obtained by subtracting out the GC/PID  $\mu\text{g}/\text{m}^3$  concentrations of compounds eluting within this range. If this adjusted C5-C8 Aliphatic Hydrocarbon value is less than the value listed in Table 4-10, measurable indoor air impacts are not likely. If more than this value, a Level 3 evaluation may be necessary.

**C9-C12 Aliphatic Hydrocarbons:** On a GC/FID, quantitate all peak elutions between n-nonane and just before naphthalene using response factors from one or several of the normal alkanes which elute in this range (e.g., n-nonane, n-decane). Conservatively assume that this entire concentration value is C9-C12 Aliphatic Hydrocarbons (even though some aromatic compounds are also likely eluting in this range). Compare this value (in  $\mu\text{g}/\text{m}^3$ ) with the value listed in Table 4-10. If less than the listed value, measurable indoor air impacts are not likely. If more than this value, consider use of a GC/PID to quantitate BTEX, naphthalene, and C9-C10 Aromatic Hydrocarbon, and “adjust” the C9-C12 Aliphatic Hydrocarbon value previously obtained by appropriate subtraction from the Aliphatic range. If this adjusted C9-C12 Aliphatic Hydrocarbon value is less than the value listed in Table 4-10, measurable indoor air impacts are not likely. If more than this value, a Level 3 evaluation may be necessary.

**C9-C10 Aromatic Hydrocarbons:** On a GC/FID, quantitate all peak elutions just after the last xylene peak and just before naphthalene using the response factor for 1,2,4-Trimethylbenzene. Conservatively assume that this entire concentration value is C9-C10 Aromatic Hydrocarbons (even though some aliphatic compounds are also likely eluting in this range). Compare this value (in  $\mu\text{g}/\text{m}^3$ ) with the value listed in Table 4-10. If less than the listed value, measurable indoor air impacts are not likely. If more than this value, consider use of a GC/PID to quantitate this range in the same manner. If this GC/PID range concentration is less than the value listed in Table 4-10, measurable indoor air impacts are not likely. If more than this value, a Level 3 evaluation may be necessary.

**Toluene, Ethylbenzene, Total Xylenes:** On a GC/PID or GC/FID, identify and quantitate Target Analyte peak via retention times and response factors/curves established for each analyte. Compare these values ( $\mu\text{g}/\text{m}^3$ ) with the values listed in Table 4-10. If all data are less than the listed values, measurable indoor air impacts are not likely. If one or more of the analytes are above their respective values, a Level 3 evaluation may be necessary.

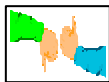

*NOTE: When using a “field” GC screening technique, all appropriate and necessary quality assurance/quality control procedures must be employed. At a minimum, the following steps would generally be expected:*

- Calibration of the GC system at a minimum of 3 concentration levels, using gaseous-phase calibration standards; and
- Daily analysis of a blank sample and mid-range calibration or QC check standard, to ensure and document system performance.

## LABORATORY PROCEDURES

Soil gas samples obtained in a bag, canister, or directly into a gas-tight syringe are analyzed using a VPH procedure (modified by changing sample introduction from purge and trap to direct injection/desorption) or by the APH methodology.

Using either the “screening” or laboratory procedure, the concentration of each fraction (in  $\mu\text{g}/\text{m}^3$ ) should be compared to the soil gas action level indicated in Table 4-10. NOTE: THESE VALUES MAY NOT BE PROTECTIVE AT BUILDINGS WITH EARTHEN FLOORS OR STANDING GROUNDWATER WITHIN A BASEMENT OR CRAWL SPACE AREA.

**Table 4-10: Soil Gas GC Screening Levels for Evaluating Indoor Air Impacts**

Fraction/Analyte	Measurable Indoor Air Impacts Not Likely if Below ( $\text{mg}/\text{m}^3$ )
C5-C8 Aliphatic Hydrocarbons	111,000
C9-C12 Aliphatic Hydrocarbons	117,000
C9-C10 Aromatic Hydrocarbons	104,000
C9-C18 Aliphatic Hydrocarbons	130,000
Toluene	36,000
Ethylbenzene	13,000
Total Xylenes	94,000

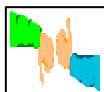

As an alternative to the active soil-gas sampling procedures detailed above, the use of passive/diffusion samplers may also be an appropriate technique to characterize and quantitate hydrocarbon vapors beneath and proximate to structures of concern.

### 4.3.1.3 Level 3 - Indoor Air Analysis

If soil gas analysis cannot rule out an indoor air impact, direct measurement of indoor air is usually necessary. At least one (2-4 hour) time-weighted sample should be obtained from the lowest occupied level of the structure and analyzed using EPA Method TO-14A/15 or the MADEP Air-Phase Petroleum Hydrocarbon (APH) methodology. (While TO-14A/15 may be used to determine if a pathway is present, the APH method is recommended to evaluate risks from such a pathway). Additional (2-4 hour) time-weighted samples on other levels of the structure could be helpful in evaluating the likelihood of a subsurface vapor infiltration pathway in the event that elevated concentrations of contaminants are identified in the lowest level (e.g., higher concentrations in upper levels could be a potential line of evidence contrary to a subsurface infiltration pathway).

Sampling during Winter or early Spring is usually considered a “worst case” evaluation, due to (a) depressurization of the structure that occurs due to the operation of combustion furnaces and chimney stack effects, (b) lack of building ventilation, (c) presence of frost layer impeding diffusion to the atmosphere, and/or (d) presence of a high groundwater table (Spring). At structures with a central air-conditioning system that obtains make-up air from a basement, worst-case conditions may be during summer months. **Sampling during times of the year that are not considered worst case may not conclusively rule out indoor air impacts.**

Concentrations of hydrocarbon fractions and Target Analytes obtained by this analysis should be evaluated to determine if they are in excess of a “background” condition for that structure. In lieu of determining a site-specific background concentration, the generic values presented in Table 4-11 may be used.

**Table 4-11: Estimated Background Indoor Air Concentrations**

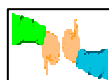

Fraction/Analyte	Estimated Generic Background	
	mg/m <sup>3</sup>	ppbV
C5-C8 Aliphatic Hydrocarbons	85	N/A
C9-C12 Aliphatic Hydrocarbons	90	N/A
C9-C10 Aromatic Hydrocarbons	80	N/A
C9-C18 Aliphatic Hydrocarbons	100	N/A
Benzene	21	6.5
Toluene	29	7.5
Ethylbenzene	10	2.2
Total Xylenes	72	17
Naphthalene	5	1
MtBE	3-18*	1-5*

*\* concentration of MtBE in ambient air; may be higher in immediate vicinity of gasoline filling stations or if gasoline storage in building (e.g., lawnmower)*

#### 4.3.1.4 Use of Vapor Transport Models

On occasion, it may be necessary or desirable to use predictive/computer models to help evaluate vapor transport issues at disposal sites. This option is most necessary when it is not possible or feasible to obtain soil gas and/or indoor air measurements, or when such data are ambiguous. While use of these techniques can aid in the understanding of the Conceptual Site Model, and facilitate characterization of current and future exposure pathways, **it is MADEP’s longstanding position that current exposure pathways should be evaluated/validated with actual site data, to the extent feasible.**

Accordingly, unless precluded by unavoidable logistical constraints and/or “background” interference (e.g., toluene migration into a commercial/industrial site where toluene is used as a raw product), *there is an expectation that (some) actual soil gas and/or indoor air data will be generated during the evaluation of sites with an exceedance of GW-2 standards.* Sufficient explanation and justification must be provided in the appropriate report submittals for sites where such data are not obtained.

Most mathematical evaluations of this vapor transport pathway involve use of the Johnson & Ettinger model. Spreadsheet applications of the model are available for downloading free of charge from MADEP at <http://www.state.ma.us/dep/bwsc/files/standard/GW2/GW2.htm> and from the US Environmental Protection Agency at [http://www.epa.gov/superfund/programs/risk/airmodel/johnson\\_ettinger.htm](http://www.epa.gov/superfund/programs/risk/airmodel/johnson_ettinger.htm).

When using models of this nature, all input parameters and values have to be individually justified as appropriate and/or conservative for the specific site in question; it is not permissible to “pick and chose” generic modeling default values absent such justification. A particularly sensitive modeling parameter in this regard is the vadose zone moisture content **below the structure of concern**, which should be empirically determined on a site-specific basis.

#### **4.3.1.5 Vertical Profiling of Groundwater Contaminants to Evaluate Vapor Transport**

In cases where soil gas and/or indoor air data are ambiguous, vertical profiling of groundwater contaminants may provide useful lines of evidence in the evaluation of vapor transport pathways.

Typically, groundwater plumes “dip” as they flow from a source area, due to the infiltration of rainfall and snowmelt. This recharge can result in the formation of a “fresh water lens” above a plume of dissolved contaminants. In such situations, contaminants must diffuse through the (uncontaminated) lens in order to reach the groundwater table/capillary fringe, and partition from the aqueous phase into the gaseous phase. Because of the slow rate of liquid-phase diffusion, the formation of such a fresh water lens can effectively eliminate the vapor transport pathway, by preventing dissolved contaminants from partitioning into the overlying vadose zone.

Predicting the exact point in the path of a plume where vapor generation is “cut off” in this manner is difficult, if not impossible, due to the transient and dynamic nature of the governing parameters. Moreover, plumes that dip will eventually reverse direction and rise toward a groundwater discharge point, where contaminants may again be flowing in close proximity to the groundwater table and aqueous/vapor interface.

Despite these difficulties and unknowns, it may be useful at some sites to profile groundwater contaminant concentrations in the first 5-10 foot interval of the saturated zone, to determine whether a freshwater lens is present at the site in question. Typically, this action is accomplished by advancement of small diameter driven well points, obtaining groundwater samples at 1 to 2 foot depth intervals, for analysis by GC screening or laboratory techniques. Such data, in conjunction with soil gas data and/or other site factors, may provide the necessary weight of evidence to adequately evaluate and/or eliminate this pathway.

#### **4.3.1.6 Response Actions at Sites with Indoor Air Impacts**

Evidence of the migration of petroleum vapors from the subsurface into a school building or occupied residential dwelling (above a background condition) represents a Critical Exposure Pathway and Condition of Substantial Release Migration under the Massachusetts Contingency Plan. In such cases, pursuant to the provisions of 310 CMR 40.0414, an Immediate Response Action must be undertaken to evaluate the risks associated with this infiltration, and determine if there is a feasible remedial measure to prevent or mitigate this continued infiltration. *If feasible mitigative options exist, remedial actions must be taken.*

When considering and implementing mitigative options, a hierarchy of remedial efforts is recommended, from least-invasive/least-costly to most-invasive/most-costly. Details are provided in Figure 4.3.

#### **4.3.2 Using a Method 2 Approach to Evaluate Exceedances of Method 1 GW-3 Standards**

The Method 1 GW -3 standard most likely to be exceeded at a petroleum-contaminated site is for C9-C10 Aromatic Hydrocarbons. This standard and all Method 1 GW -3 standards were derived based upon an assumption that (a) impacts may occur to ecological receptors in a surface water body at concentrations equal to or greater than the ambient water quality guideline, (b) groundwater from the site is discharging to such a surface water body, and (c) dilution between the groundwater and surface water body is minimal. A summary and description of currently recommended fractional ambient water quality guidelines is provided in Table 4-12.

Using a Method 2 approach, site-specific data, fate and transport factors, and/or predictive models may be used to modify Method 1 GW -3 standards. Recommended fractional fate and transport parameters are provided in Section 4.6. *Note that per 310 CMR 40.0982(4), a Method 1 GW-3 standard cannot be modified to a concentration in excess of the Upper Concentration Limit for the fraction of interest.*

**Figure 4-3: Recommended Hierarchy of Vapor Mitigation Efforts**

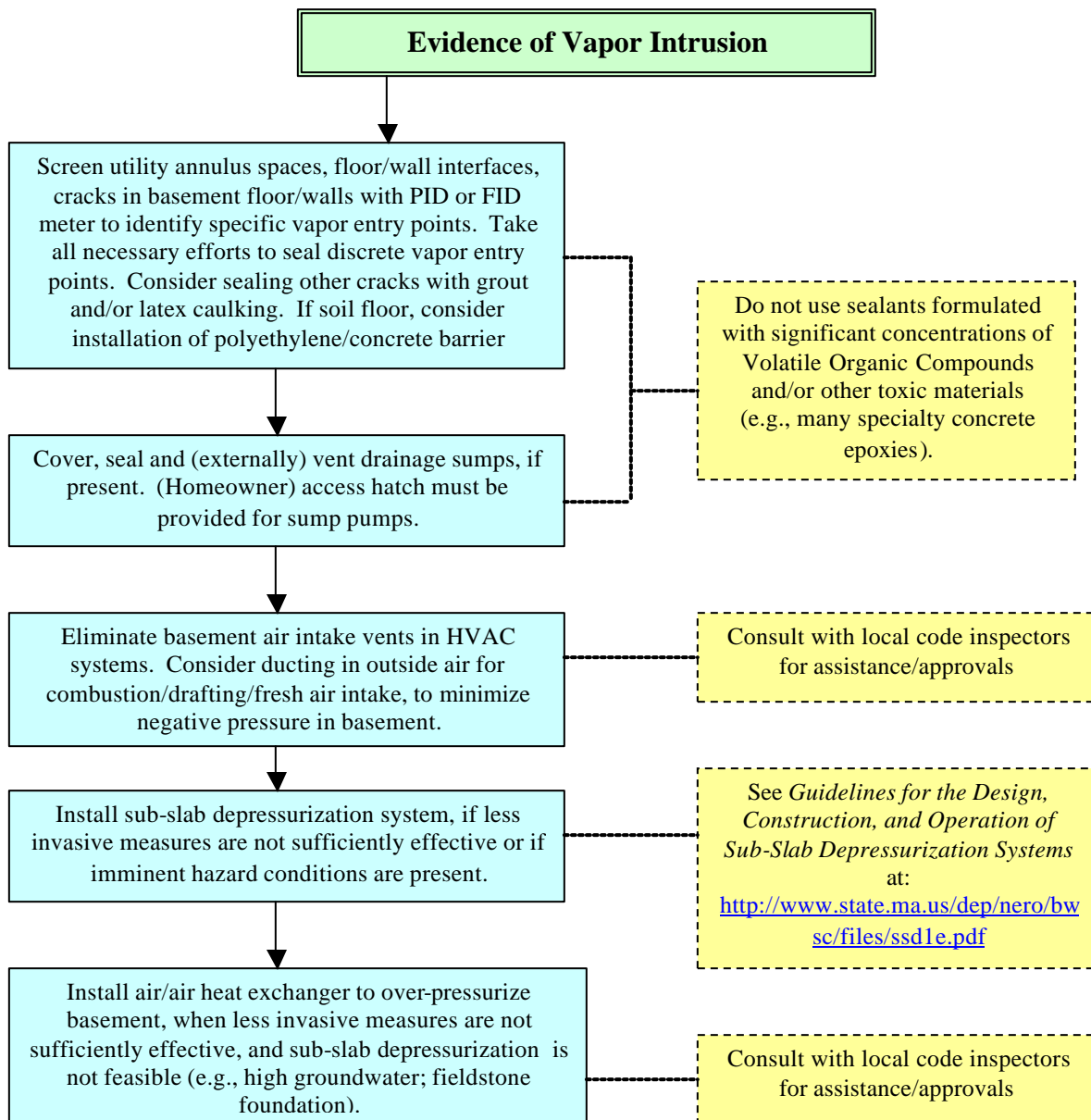

**Table 4-12: Recommended Surface Water Quality Guidelines**

Fraction	Surface Water Guideline (mg/L)	Basis of Guideline
C5-C8 Aliphatics	250 <sup>a</sup>	Acute LC50/10 for Hexane (as surrogate for this range)
C9-C12 Aliphatics	1800	Acute LC50/10 for Decane (as surrogate for this range)
C9-C10 Aromatics	540 <sup>a</sup>	Acute LC50/10 for Trimethylbenzene (as surrogate for this range)
C9-C18 Aliphatics	1800	Acute LC50/10 for Decane (as surrogate for this range)
C19-C36 Aliphatics	2100	Acute EC50/10 for Cyclododecane (as surrogate for this range)
C11-C22 Aromatics	N.A. <sup>a</sup>	Effects may be seen at less than the EPH Reporting Limit; other testing methods (e.g., GC/MS) may be needed on site-specific basis

<sup>a</sup>updated value (2002)

In lieu of site-specific modeling, the conservative dilution factors graphically illustrated in Figure 4-4 may be used as part of a Method 2 evaluation of groundwater-to-surface-water impacts dissolved hydrocarbon contaminants.

**Figure 4-4: Groundwater Dilution Factors for Dissolved Hydrocarbons**

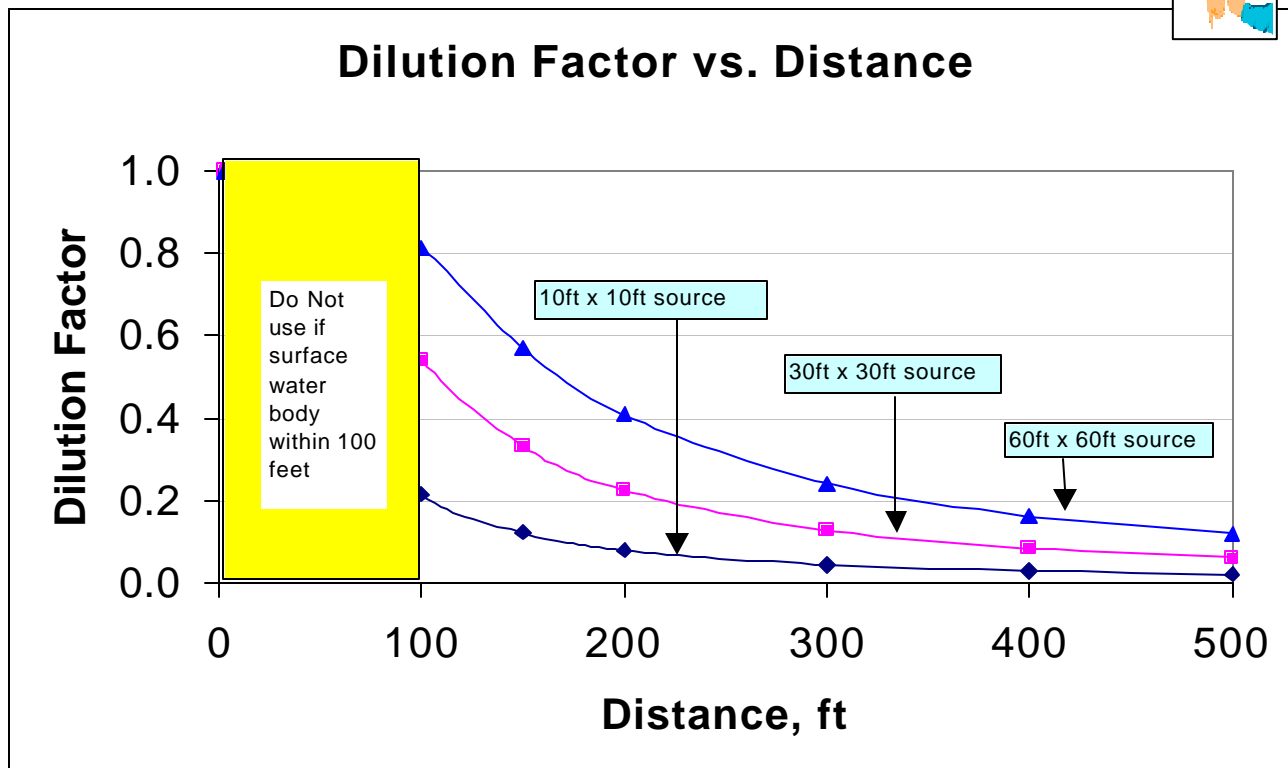

**Equations:**

10ft x 10ft source area,  $DF = 177 (\text{distance in feet})^{-1.455}, r^2 = 0.99$   
 30ft x 30ft source area,  $DF = 303 (\text{distance in feet})^{-1.365}, r^2 = 0.99$   
 60ft x 60ft source area:  $DF = 237 (\text{distance in feet})^{-1.214}, r^2 = 0.99$

The graphs presented in Figure 4-4 are generalized, source-area dependent conservative dilution and dispersion curves for any dissolved groundwater contaminant, including hydrocarbon range fractions and Target Analytes. They were developed using the Domenico and Robbins analytical transport model (1985) assuming an infinite source condition. The only attenuation mechanism considered is hydrodynamic dispersion, and as such may be used for any dissolved organic compound.

The use of these graphs, however, is limited to sites where **ALL** of the following conditions are met:

- ◇ groundwater/contaminant flow is occurring only in an overburden aquifer;
- ◇ there is no “short circuiting” of groundwater/contaminants along preferred flow paths;
- ◇ no fractional range is present at a concentration greater than 100,000 µg/L (i.e., exceeding UCLs); and
- ◇ the nearest downgradient surface water body is at least 100 feet from the impacted well/groundwater area on the site.

**Because of modeling uncertainties, and limitations that typically exist on the availability of temporal and spatial groundwater monitoring data, the graphs and equations contained in Figure 4-4 may not be used at sites where the distance to surface water is less than 100 feet.**



Using Figure 4-4, it is possible to conservatively calculate the concentration of a hydrocarbon range or Target Analyte of interest at some distance from a site (typically, a monitoring well located at a site). For example, at a site in which the source area of contamination is approximately 30ft x 30ft, if the concentration of C<sub>9</sub>-C<sub>10</sub> Aromatic Hydrocarbons in a well located 400 feet from a receiving water is 600 µg/L, a (dimensionless) Dilution Factor of 0.09 is obtained from Figure 4-4. Multiplying this Dilution Factor by 600 µg/L yields 54 µg/L, which would be a conservative estimate of the maximum concentration of C<sub>9</sub>-C<sub>10</sub> Aromatic Hydrocarbons in groundwater that would migrate to this point. An additional dilution factor may then be applied to account for the mixing of groundwater with the surface water, based upon site-specific information and data.

Parties wishing to provide alternative ambient water quality guidelines for the VPH/EPH fractions, and/or provide a site-specific evaluation of environmental impacts, must do so via a MCP Method 3 approach.

#### 4.3.3 Using a Method 2 Approach to Evaluate Leaching

All Method 1 soil standards consider leaching impacts to underlying groundwater. The leaching-based component of the Method 1 standards were derived using the SESOIL and AT123D computer models to evaluate unsaturated and saturated zone transport, as depicted in Figure 4-5.

**Figure 4-5: Leaching Scenario Used to Develop Leaching-Based Method 1 Soil Standards**

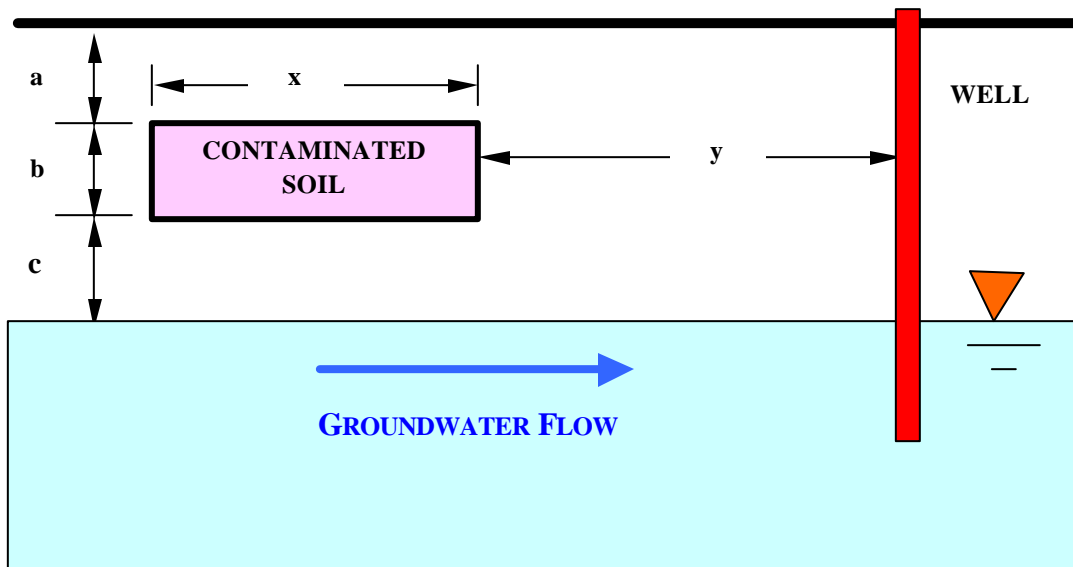

The standards developed by MADEP in 1993 were based upon a deterministic modeling effort, using “point” value input parameters (i.e., in Figure 4-5 a, b, and c = 1 meter, x and y = 10 meters). More recent efforts by MADEP have involved use of a probabilistic modeling approach, using ranges or distributions for input parameters. In all cases, “Dilution and Attenuation Factors” were developed to relate concentrations of soil contaminants in the source area to concentrations of those contaminants in a hypothetical “point of compliance” downgradient monitoring well.

Based upon the assumptions and models used by MADEP, the only VPH/EPH Method 1 soil standard controlled by leaching concerns is C11-C22 Aromatics in GW-1 (drinking water) areas. However, the Method 1 soil cleanup standards for two important Target Analytes - naphthalene and 2methylnaphthalene - are also controlled by leaching considerations.

Using a Method 2 approach, site-specific data, fate and transport factors, and/or predictive models may be used to modify a Method 1 soil standard that is based upon leaching concerns. In such an exercise, the site-specific soil concentration(s) of a hydrocarbon fraction or Target Analyte of interest is used to predict maximum groundwater concentrations that may be expected in areas beneath and downgradient of the contaminated soil. These

groundwater concentrations are then compared to the appropriate Method 1 or 2 groundwater standards. A modified soil standard derived in this manner is acceptable if:

- ◇ the maximum predicted groundwater concentration of the contaminant of interest downgradient of the zone of soil contamination is at or below the appropriate Method 1 or 2 GW standard; and
- ◇ the modified soil standard does not exceed the appropriate S-1, S-2, or S-3 levels which are protective of direct-contact exposure concerns [as listed at 310 CMR 40.0985(6)].

Example: under a Method 2 approach, the S 1/GW-1 Method 1 standard for C11-C22 Aromatic Hydrocarbons can be modified, based upon site-specific leaching considerations, to a maximum concentration of 800 µg/g, which is the level at which the human health risks associated with direct contact controls the setting of this standard.

*Note that while the generic Method 1 standards were predicated on a specified or probabilistic downgradient receptor of concern, (e.g., 10 meters downgradient of the source area), actual site-specific conditions and receptors should be used when undertaking a Method 2 evaluation effort (e.g., buildings, surface water bodies, GW-1 areas).*

Recommended fractional fate and transport parameters are provided in Section 4.6. For additional information on the calculation of leaching-based Method 1 soil standards, consult *Background Documentation for the Development of the MCP Numerical Standards* (MADEP, 1994 and as amended).

In lieu of or in conjunction with predictive models, the use of groundwater monitoring data is often an acceptable and cost-effective means to evaluate site-specific leaching concerns. In order to have sufficient confidence in such an approach, however, the following site conditions are desirable:

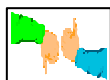

- ◇ the release occurred at least 24 months ago;
- ◇ the depth between the zone of soil contamination and groundwater table is less than 6 feet;
- ◇ the surface(s) overlying the contaminated soil is pervious (i.e., no pavement or buildings);
- ◇ the number and location of monitoring wells are sufficient to characterize groundwater quality below and downgradient of the zone of soil contamination; and
- ◇ sufficient temporal monitoring data exist to evaluate seasonal trends.

## 4.4 Method 3 Risk Characterization

Under Method 3, a completely site-specific evaluation is conducted to determine risks to human health, safety, public welfare, and the environment. Recommended toxicological and fate and transport values for the VPH/EPH fractions in this regard are provided in Tables 4-13 and 4-14, respectively. Although it is not necessary to use any of these values in a Method 3 risk characterization effort, the burden is on the party conducting the assessment to document and defend the selection of alternative assumptions, parameters, and values. Complete details on the Method 3 risk assessment process are provided in *Guidance for Disposal Site Risk Characterization* (MADEP, 1995 and as amended).

### 4.4.1 Requirements and Limitations of a Method 3 Characterization

While a Method 3 characterization allows a significant degree of flexibility, there are important obligations and limitations:

- ◇ **Site-specific risks to public welfare must be evaluated.** Under the Massachusetts “superfund” legislation (MGL c. 21E), risks to public welfare are given the same weight as risks to human health, safety, and the environment. In deriving the Method 1 standards, MADEP imposed ceiling levels on acceptable concentrations of contaminants, in an attempt to ensure that each standard would be set at a low enough level to rule out significant impacts to public welfare. “Public welfare” is a difficult standard to articulate, and it is much easier to define a *de minimis* condition, than to define a precise point where a risk to public welfare becomes significant. Nevertheless, parties conducting a Method 3 assessment must make an independent evaluation of all relevant public welfare concerns, and conclude that all such concerns are below a level of *No Significant Risk*.
- ◇ **Site-specific risks to ecological receptors must be evaluated.** Under the MCP, environmental risk assessment is done via a two-stage process. Stage I is a screening process used to (1) eliminate from further consideration those sites where exposures are clearly unlikely to result in environmental harm, or, on the other extreme, (2)

eliminate from further consideration those sites where harm is readily apparent (i.e., it is clear that remediation is needed, and additional study is not necessary). Those sites that are not eliminated must proceed to a Stage II evaluation, which involves a quantitative, site-specific characterization of the risk to ecological receptors.

- ◇ **A Method 3 approach cannot be used to modify or eliminate Upper Concentration Limits.** Upper Concentration Limits (UCLs) are “gross” levels of contamination in soil and groundwater that, by their very presence in the environment, constitute a significant risk to public welfare and the environment. Under the provisions of 40.0996(2), the UCL standards are to be applied to the arithmetic average of the concentration of oil or hazardous materials at a site or within a “hot spot”. If the average concentrations of site contaminants exceed an applicable UCL value, remediation must be undertaken to treat or encapsulate areas of concern, if feasible. In cases where it is not feasible to remediate such conditions, it may be still possible to obtain an interim site closure by filing a Class C Response Action Outcome, representing a Temporary Solution.
- ◇ **A Permanent Solution cannot be achieved if drinking water standards are exceeded in a GW-1 area.** In conducting a Method 3 assessment, all applicable or suitably analogous health standards must be identified and achieved. Under the provisions of 310 CMR 40.0993(3)(a), the Massachusetts Drinking Water Quality Standards promulgated in 310 CMR 22.00 are considered applicable in all GW -1 areas. While drinking water standards have been promulgated for a number of Target Analytes (e.g., benzene at 5 µg/L), at the present time, the VPH/EPH fractional ranges are not included on this list. While it is necessary to characterize the risk these fractional ranges pose to the water supply of concern, it is not necessary to consider these values “analogous health standards”.

#### 4.4.2 Impacts to Indoor Air

Relevant guidance contained in Section 4.3.1 should be considered by parties undertaking an evaluation of impacts to indoor air as part of a Method 3 risk assessment process. The use of the inhalation RfC values provided in Table 4-13 would be a conservative means to quantitate risks via the inhalation pathway, and use of the estimated background concentration values listed in this table would be a conservative means to evaluate Critical Exposure Pathways.

#### 4.4.3 Odors as a Significant Risk to Public Welfare

Under the provisions of 310 CMR 40.0994, the existence of a nuisance condition shall be considered in a characterization of risks to public welfare. Given the low odor recognition thresholds of many petroleum constituents (and breakdown products), the presence of odors at petroleum-contaminated sites can constitute a nuisance condition, and preclude achievement of a condition of No Significant Risk to Public Welfare, *even if a condition of No Significant Risk to Human Health has been achieved.*

Definitive and quantitative guidelines and standards on when a petroleum odor constitutes a nuisance condition and significant risk to public welfare are difficult to articulate. In the context of petroleum-contaminated sites, however, the following **Rules of Thumb** are suggested for when an odor condition would generally NOT be considered a nuisance condition:

- ◇ Odors observed in the subsurface during excavation or boring advancement would generally not be considered a nuisance condition, as long as such odors are not detectable in ambient or indoor air, and as long as there are no plans to excavate or disturb such areas.
- ◇ Odors observed in the breathing zone of the ambient air, or indoor air of an impacted structure, would generally not be considered a nuisance condition, if such odors do not persist for more than 3 months.
- ◇ Odors observed in the breathing zone of the ambient air would generally not be considered a nuisance condition if they are discernable less than 10 days a year.
- ◇ Odors observed in the ambient air or indoor air of an impacted structure would generally not be considered a nuisance condition if the occupants of such a structure do not believe such odors significantly affect or degrade their quality of life.

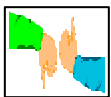

#### 4.4.4 MADEP Petroleum-Contaminated Site Risk Assessment Short Forms

To streamline the Method 3 risk assessment process, MADEP has developed a series of Risk Assessment “Short Forms” which incorporate the aliphatic and aromatic fractional ranges, for optional use at sites contaminated by various petroleum products. Like other MADEP Short Forms, these spreadsheet-based tools incorporate standardized exposure assumptions and toxicological profiles, and allow the user to input site-specific concentration data. The output is a series of summary tables that describe chemical-specific, medium-specific, and cumulative (total site) risks, which may be used and/or applied as part of a Method 3 risk assessment at petroleum-contaminated sites.

The Short Forms, and supporting documentation, are available for downloading from the MADEP Web site, at <http://www.state.ma.us/dep/ors/orspubs.htm>

### 4.5 Recommended Toxicological Parameters

The currently recommended toxicological values for assessing risks associated with the VPH/EPH aliphatic and aromatic hydrocarbon fractions are listed in Table 4-13. Note that these values are subject to change as additional information and data become available to MADEP.

**Table 4-13: Recommended VPH/EPH Toxicological & Risk Assessment Parameters**

	C5-C8 Aliphatics	C9-C12 Aliphatics	C9-C10 Aromatics	C9-C18 Aliphatics	C19-C36 Aliphatics	C11-C22 Aromatics
Chronic Oral RfD (mg/kg/day)	0.04 <sup>a</sup>	0.1 <sup>a</sup>	0.03	0.1 <sup>a</sup>	2.0 <sup>a</sup>	0.03
Subchronic Oral RfD (mg/kg/day)	0.4 <sup>a</sup>	1.0 <sup>a</sup>	0.3	1.0 <sup>a</sup>	6 <sup>a</sup>	0.3
Chronic Inhalation RfC (mg/m3)	200	200	50 <sup>a</sup>	200	N/A	50 <sup>a</sup>
Est. Background Indoor Air (mg/m3)	≤85	≤90	≤80	≤100	N/A	≤50
Chronic RAF - Soil Ingestion	1 <sup>a</sup>	1 <sup>a</sup>	1 <sup>a</sup>	1 <sup>a</sup>	1 <sup>a</sup>	0.36 <sup>a</sup>
Chronic RAF - Soil Dermal	1 <sup>a</sup>	0.5 <sup>a</sup>	0.5 <sup>a</sup>	0.5 <sup>a</sup>	0.1	0.1 <sup>a</sup>
Chronic RAF – Water Ingestion	1	1	0.91	1	1	0.91
Subchronic RAF - Soil Ingestion	1 <sup>a</sup>	1 <sup>a</sup>	1 <sup>a</sup>	1 <sup>a</sup>	1 <sup>a</sup>	0.36 <sup>a</sup>
Subchronic RAF - Soil Dermal	1 <sup>a</sup>	0.5 <sup>a</sup>	0.5 <sup>a</sup>	0.5 <sup>a</sup>	0.1	0.18
Subchronic RAF - Water Ingestion	1	1	0.91	1	1	0.91
Ambient Water Quality Guide (mg/L)	250 <sup>a</sup>	1800	540 <sup>a</sup>	1800	2100	N.A.. <sup>a,b</sup>

<sup>a</sup> updated value (2002)

<sup>b</sup> see table 4-12

### 4.6 Recommended Fate and Transport Parameters

For recommended approaches, procedures, and values to conduct fate and transport evaluation/modeling of Target Analytes and hydrocarbon ranges, consult *Volume 3: Selection of Representative TPH Fractions Based on Fate and Transport Considerations*, a (1997) publication prepared by the Total Petroleum Hydrocarbon Criteria Working Group (TPHCWG), available at <http://www.aehs.com/whatsnew.htm>.

Relative to the VPH and EPH hydrocarbon ranges – FOR MODELING PURPOSES ONLY - recommended fractional properties are provided in Table 4-14.

**Table 4-14 : Recommended VPH/EPH Fractional Properties for Modeling Purposes**

	Equivalent Carbon Number (EC)	Molecular Weight	Vapor Pressure (atms)	Solubility in Water (mg/L)	Henry's Constant, H (dimensionless)	Partition Coeff, Koc (mL/g)	Diffusion Coeff (cm <sup>2</sup> /s)	
							air	water
C5-C8 Aliphatics	6.5	93	0.10	11,000	54	2265	0.08	1 x 10 <sup>-5</sup>
C9-C12 Aliphatics	10.5	149	8.7 x 10 <sup>-4</sup>	70	65	1.5 x 10 <sup>5</sup>	0.07	1 x 10 <sup>-5</sup>
C9-C10 Aromatics	9.5	120	2.9 x 10 <sup>-3</sup>	51,000	0.33	1778	0.07	1 x 10 <sup>-5</sup>
C9-C18 Aliphatics	12	170	1.4 x 10 <sup>-4</sup>	10	69	6.8 x 10 <sup>5</sup>	0.07	5 x 10 <sup>-6</sup>
C19-C36 Aliphatics	considered immobile							
C11-C22 Aromatics	14	150	3.2 x 10 <sup>-5</sup>	5800	0.03	5000	0.06	1 x 10 <sup>-5</sup>

#### 4.7 Non-Aqueous Phase Liquids (NAPL)

The presence of non-aqueous phase liquids (NAPL) adds significant complexity to the assessment and remediation of petroleum-contaminated sites. Of primary concern are (1) the bulk fluid migration of petroleum NAPL, and potential discharge into underground structures, utilities, and/or surface water bodies, and (2) NAPL acting as a continuing source of soil, groundwater, and/or soil gas contamination. Due to these concerns, under the provisions of 310 CMR 40.0996(4), the presence of a non-aqueous phase liquid having a thickness equal to or greater than 0.5 inches in *any environmental medium* is considered an exceedence of an Upper Concentration Limit (UCL).

##### 4.7.1 Upper Concentration Limits

A *single* measurement of  $\geq 0.5$  inches NAPL in a *single* groundwater monitoring well does not necessarily constitute exceedence of a UCL standard:

- ◇ The standard applies to the formation, not a groundwater monitoring well. Typically, the thickness of NAPL measured in a monitoring well does not correspond to the thickness of NAPL in the surrounding formation. Moreover, seasonal and short-term water table fluctuations and tidal influences will affect apparent levels of petroleum product thickness in monitoring wells, with thickness levels often increasing with a declining water table, and decreasing or “disappearing” with a rising water table. Although the relationship between the thickness of NAPL in a monitoring well and the surrounding formation is not easily established, there may be methods and sites for which reasonable assumptions and conclusions can be reached, based upon:

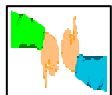

- \* an evaluation of formation properties, especially the thickness of the capillary fringe;
- \* an evaluation of test pit, split-spoon, and/or analytical screening observations within the presumed NAPL “smear zone”; and
- \* an evaluation of sufficient spatial and temporal monitoring well data, relative to the observed thickness of the NAPL and the elevation of the potentiometric surface.

- ◇ As with all UCL standards, averaging of data is permissible. In the case of NAPL, however, temporal averaging of data from monitoring wells is generally not appropriate, due to distortions introduced by a falling and rising water table.
- ◇ It is permissible to spatially average wells within the contiguous area of the NAPL plume, excluding “hot spots”, which are defined by the MCP to be discrete areas where the thickness of NAPL is more than 10 times the thickness of surrounding areas.

##### 4.7.2 Apparent NAPL Thickness vs. Actual NAPL Thickness

The occurrence, detection and migration of non-aqueous phase liquids in the subsurface are a complex phenomenon. Many investigators have attempted to develop theoretical and/or empirical methods to correlate the apparent

thickness of NAPL, as measured in a monitoring well, to the actual thickness of that NAPL in the surrounding formation. Most of these methods involve relationships based upon the density of the liquid hydrocarbon (de Pastrovich *et al.*, 1979), properties of the geologic medium (Hall *et al.*, 1984), height of the capillary fringe (Blake and Hall, 1984; Ballesterro *et al.*, 1994; and Schiegg, 1985), and/or idealized capillary pressures in homogeneous porous media (Farr *et al.*, 1990; and Lenhard and Parker, 1990). Unfortunately, none of the methods or approaches presented to date appears to be sufficiently reliable or reproducible at field sites, especially when significant fluctuations occur in the elevation of the groundwater table.

Despite these limitations, at most sites, it is likely that the *maximum* apparent (measured) thickness of light non-aqueous phase liquid (LNAPL) in a monitoring well is significantly greater than the actual thickness of that LNAPL in the surrounding formation. This phenomenon occurs when a monitoring well is installed into a formation in which mobile LNAPL is pooled on top of the capillary fringe above the water table. In such cases, LNAPL will flow into the monitoring well, depressing the true elevation of the potentiometric surface, until such time as equilibrium is achieved with the level of the LNAPL above the capillary fringe, and the weight/density of the hydrocarbon liquid in the well.

**While LNAPL occurrence and measurement is a complicated matter, it is possible to make one simple conclusion: it is usually not possible to adequately characterize this concern without sufficient temporal gauging data. At a minimum, monitoring activities should include at least 4 rounds of gauging during the 4 seasons of the year.**

Until such time as additional guidance is available on this topic, site investigators must undertake a “weight of evidence” approach to determine compliance with the 0.5 inch NAPL standard. A conservative approach would be to assume that the maximum (temporal) LNAPL thickness *observed* in a monitoring well is equivalent to the *actual* thickness of LNAPL in the formation. If the spatial average of these values within an area of concern (excluding hot spots) is less than 0.5 inches, compliance has been achieved. If the average of these values – or of a hot spot area – is greater than 0.5 inches, additional evaluations/calculations are needed to relate the observed/apparent thickness to actual formation thickness.

#### 4.7.3 NAPL and Vapor/Indoor Air Impacts

Volatile non-aqueous phase liquids (NAPL), including separate-phase gasoline, kerosene, jet fuels, and fresh diesel/#2 fuel oils, can result in the generation of significant concentrations of volatile petroleum hydrocarbon vapors in the vadose zone, which can potentially impact the indoor air of nearby structures. Purging a monitoring well containing such NAPL prior to obtaining a groundwater sample may underestimate risks of this nature, as the groundwater sample may contain relatively low concentrations of dissolved hydrocarbons. *For this reason, soil gas investigations should be considered at any site at which volatile NAPL has been identified in monitoring wells or test pits, to characterize the risks posed to indoor air quality, and determine whether use of a Method 1 approach is appropriate*

## 4.8 Elimination of Continuing Sources

Under the provisions of 310 CMR 40.1003(5), a permanent solution cannot be achieved at a site if a continuing source(s) of environmental contamination is present. At petroleum-contaminated sites, the following conditions could constitute a continuing source:

- ◇ *Abandoned Storage Tanks* - any abandoned storage tank containing any amount of mobile and/or soluble petroleum product would be considered a continuing source of environmental contamination, regardless of its current condition, unless such a tank has been closed pursuant to all applicable federal, state, and local regulations.
- ◇ *Septic Tanks/Dry Wells* - any wastewater storage, conveyance, or disposal system containing significant quantities of Non-Aqueous Phase Liquids (NAPL) would be considered a continuing source of environmental contamination, unless such systems are operating in compliance with all applicable federal, state, and local regulations.

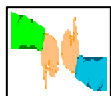

- ◇ *Gasoline NAPL* - measurable amounts of gasoline NAPL could constitute a continuing source of environmental contamination, unless modeling, groundwater and/or soil gas monitoring data can demonstrate decreasing concentrations of dissolved and/or vapor-phase contaminants over time.
- ◇ *Gasoline/VPH-contaminated soils* - concentrations of VPH fractions in soil above applicable Method 1 standards could constitute a continuing source of environmental contamination, unless modeling, groundwater and/or soil gas monitoring data can demonstrate decreasing concentrations of dissolved and/or vapor-phase contaminants over time.

## 4.9 Feasibility of Achieving Background Concentrations

Under the provisions of MGL c. 21E and the MCP, a permanent solution shall, *at a minimum*, achieve a condition of No Significant Risk. However, the statute and regulations go one step further: a permanent solution shall also include measures to reduce contaminant levels in the environment to concentrations that achieve or approach a “background” condition, *to the extent such measures are feasible*. Thus, remedial decisions under the MCP are predicated on two distinct evaluation processes: risk and feasibility. Generic and site-specific procedures and criteria to evaluate and eliminate significant risk are extensively detailed in the MCP and associated guidance documents. Procedures and criteria to evaluate the feasibility of achieving or approaching background are less defined, and are typically considered on a site-by-site basis.

A feasibility evaluation of this nature identifies and weighs the benefits and costs of eliminating or minimizing the mass or volume of contaminants in the environment, beyond a “risk-based” endpoint. The costs of such actions can be generally calculated. The benefits are less quantifiable, but include property-value/economic and non-pecuniary benefits, as well as potential health benefits. With respect to the latter, it is important to understand that all risk-based standards have inherent uncertainties, due to limitations in our understanding of how toxins affect human and ecological receptors; these limitations are especially true and problematic when considering potential synergistic effects of multiple contaminants, and exposures to sensitive populations (e.g., children). While most standards are thought to be conservative, better studies and future data may lead to a different conclusion. A good example in this regard is the risk-based GW-1 standard for MtBE, which in recent years has been lowered by MADEP from 700 µg/L to 70 µg/L (and which may be lowered even further in the future).

While it is necessary to consider the feasibility of achieving or approaching background at petroleum-contaminated sites, certain attributes of petroleum hydrocarbons are germane to the benefit/cost evaluation, and allow for generalized conclusions and recommendations on feasibility issues. Specifically, most of the petroleum hydrocarbons contained in gasoline and lighter fuel oils are biodegradable, under both aerobic and anaerobic conditions. At most sites, residual levels of such contaminants will naturally degrade to levels that achieve or approach a background condition, in a foreseeable time period. In such cases, the “benefit” side of the feasibility equation becomes more an issue of timing than of concentration endpoints: is the benefit of *accelerating* this mass reduction worth the cost?

Based upon the above, certain generic guidelines are offered to streamline background restoration considerations at sites contaminated ONLY with petroleum hydrocarbons:

- ◇ Given the typical “asymptotic” response for contaminant reduction in aquifer systems, at sites contaminated solely by releases of gasoline or diesel fuel oil, achieving or approaching background concentrations of petroleum hydrocarbons in *groundwater* may generally be considered infeasible, provided that indigenous or enhanced microbial populations present at the site of concern would be expected to naturally degrade petroleum hydrocarbon concentrations.
- ◇ Achieving or approaching background concentrations of petroleum hydrocarbons may generally be considered infeasible in soils that are located beneath a permanent structure.
- ◇ Achieving or approaching background concentrations of petroleum hydrocarbons may generally be considered infeasible at sites where such remedial activities would interrupt vital public services and/or threaten public safety (e.g., energy interruption; traffic disruption).



**It is important to stress that the above guidelines pertain only to the feasibility of remediation beyond a risk-based endpoint.** Under the MCP, all sites must achieve a condition of No Significant Risk.

Additional policy documents on this subject are currently under development by MADEP; refer to the BWSC publication page at <http://www.state.ma.us/dep/bwsc/pubs.htm> to track progress/provide input in this regard.

## 5.0 IMPLEMENTATION ISSUES

### 5.1 Site Characterization

#### 5.1.1 Analytical Parameters

Recommended Target Analytes and VPH/EPH hydrocarbon ranges of interest for the most commonly released petroleum products are detailed in Tables 4-3, 4-5, and 4-6.

#### 5.1.2 Site and Media Characterization

Site characterization may involve evaluation and/or testing of NAPL, soil, groundwater, surface water, soil gas, ambient air, indoor air, or freshwater or marine sediments. Decisions of this nature are necessarily site-specific, based upon the type and quantity of petroleum product(s) released, depth to groundwater, and sensitivity of potential pollutant receptors.

**Rules of Thumb** for the most commonly released petroleum products and problematic situations are provided below:

##### NAPL

- ◇ When gauging a well for the purpose of monitoring the presence and thickness of NAPL, it is essential that all free-phase petroleum product be evacuated from the well after each gauging round, to help ensure that the well remains in good hydraulic communication with the surrounding formation, and accurately reflects dynamic aquifer conditions.
- ◇ Generally, it is not possible (or meaningful) to attempt to measure the concentration of dissolved petroleum product in a monitoring well which contains a measurable thickness of NAPL.

##### Soil

- ◇ When obtaining samples at an UST grave for the purposes of determining an Exposure Point Concentration (EPC), it is necessary to specifically investigate whether a “hot spot” exists within the groundwater table fluctuation zone (i.e., the “smear zone”). For gasoline and fresh diesel/fuel oil releases, this action may be easily accomplished by headspace analysis of samples from sidewall excavations using a PID meter. In cases where headspace concentrations within this smear zone are equal to or greater than 10 times other locations on the sidewall, soil samples from this zone should be discretely collected/composited (either as the sidewall sample or with other sidewall samples) for appropriate analysis.

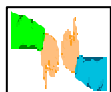

##### Groundwater

- ◇ Regardless of the type of petroleum product released, groundwater characterization should be undertaken at any site where the distance to a groundwater withdrawal well is less than 500 feet.
- ◇ In most cases, it is necessary to obtain groundwater samples to adequately characterize releases of gasoline, aviation gasoline, and military jet fuels. Exceptions may include: very small releases of product (less than a few gallons), or sites with a deep vadose zone (>30 feet to the groundwater table), **IF** there are no sensitive receptors (e.g., no groundwater withdrawal wells or potentially impacted structures). At sites where the groundwater table is located in bedrock, the use of passive and/or active soil gas sampling is recommended to help determine if NAPL or significant concentrations of dissolved constituents are present in the groundwater.
- ◇ At sites where there has been a release of diesel/#2 fuel oil, and where excavation is being accomplished to remove a tank or contaminated soil, an attempt should be made to reach the groundwater table using on-site equipment. If reached, visible observations of the presence or absence of NAPL should be documented, and a groundwater and/or soil sample (from within the groundwater fluctuation zone) should be obtained



for analysis by a TPH or EPH methodology. If not reached, the installation of a groundwater monitoring well would generally not be necessary if (a) site data, before or after remediation, document concentrations of EPH fractional ranges below appropriate Method 1 standards, and (b) there are no groundwater withdrawal wells within 500 feet. Further guidance on tank removal is available in *Commonwealth of Massachusetts Underground Storage Tank Closure Assessment Manual*, DEP Policy # WSC-402-96, April, 1996.

- ◇ At gasoline-contaminated sites, particular attention and emphasis should be placed on the characterization of MtBE in groundwater. This compound, an additive in unleaded gasoline, is extremely soluble and mobile, and can migrate significant distances in groundwater. While most petroleum hydrocarbon plumes tend to biodegrade before significantly “dipping” below the groundwater table, MtBE plumes can “sink” below the typical 10-foot water table well screens in monitoring wells with increasing distance from a source area, necessitating consideration of deeper wells in downgradient plume areas (i.e., beyond about 100 meters from the source area). Moreover, unlike BTEX and other petroleum hydrocarbons, MtBE may not be a good candidate for natural attenuation, as it does not tend to volatilize, sorb to soils, or readily biodegrade. *Recent information and data developed by the USEPA (2002) have disclosed that conventional sampling and analysis techniques can significantly underestimate MtBE concentration in groundwater; additional details and recommendations are provided in Appendix 1.*
- ◇ When investigating vapor partitioning/transport concerns due to the presence of an open groundwater collection sump in a basement structure, it is recommended that 3-5 sump volumes of water be evacuated (as permitted by site/recharge conditions) immediately prior to sampling, to ensure collection of a representative sub-slab groundwater sample.

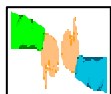

#### **Soil Gas/Indoor Air**

- ◇ Testing of soil gas and/or indoor air should be considered at any site where (a) a groundwater sump is present within a potentially impacted structure, (b) an earthen floor is present within a potentially impacted structure, (c) volatile LNAPL is present beneath or near a potentially impacted structure, or (d) contaminated soils are located within 5 feet of a potentially impacted structure (including beneath a basement slab). Note that the current MCP Method 1 soil standards do NOT consider the direct partitioning of volatile contaminants from impacted soils to an overlying or nearby structure, or impacts from groundwater that infiltrates a structure.
- ◇ When the objective for indoor air sampling is to determine whether a Critical Exposure Pathway (CEP) is present at a home or school, testing must be conducted under “worst case” site conditions; spatial and temporal averaging of indoor air data, while potentially appropriate for determining Exposure Point Concentrations for risk assessment purposes, is NOT appropriate when evaluating CEP conditions. Additional discussions in this regard are provided in Section 4.3.

#### **5.1.3 Filtering of Groundwater Samples**

The objective of a groundwater characterization program is to determine the concentrations of contaminants within, and moving through, an aquifer or formation. Groundwater monitoring wells are installed to help meet this objective. However, monitoring wells are not perfect instruments for this purpose, as they can introduce a (false-positive) bias in the form of (a) suspended sediments containing significant concentrations of sorbed (non-dissolved) hydrocarbons, and/or (b) colloidal suspensions of non-aqueous phase liquids (NAPL). In either case, the analyses of water samples from such wells can provide an overquantitation of contaminant levels of concern. For this reason, groundwater samples are sometimes filtered prior to analyses, generally through a 0.45 micron filter. However, filtering in such a manner can produce a (false-negative) bias, by (1) removing particles smaller than 0.45 microns, and/or (2) removing colloids that are in fact contaminants that are moving through a formation.

Recommendations on this issue are outlined below:

- ◇ The use and sampling of properly installed, constructed, and developed groundwater monitoring wells, using low-flow sampling techniques, is a preferred alternative to filtering. Recommended guidance and a standard operating procedure for low-flow/low-stress groundwater sampling is available from the EPA Region I website at: <http://www.epa.gov/region01/measure/well/wellmon.html>

- ◇ Samples obtained from potable water supply wells should NOT be filtered prior to analysis.
- ◇ Filtering should generally NOT be conducted in monitoring wells outside the “source area” of a petroleum release. Such wells are designed to determine the dissolved plume migration of petroleum contaminants, and should not contain suspended sediments with significant concentrations of sorbed hydrocarbons, or any NAPL.
- ◇ When filtering samples, the use of an “in line” device is recommended, to minimize handling and disturbance of the sample.
- ◇ When filtering samples, the collection and analysis of a separate (split) non-filtered sample may be appropriate, to help discern biases present in the characterization process, and determine compliance with characterization objectives.

**Because of the potential to produce a false-negative/bias, all site investigations that rely upon data obtained from filtered groundwater samples must include an adequate discussion and justification for using such techniques.**

## 5.2 Use of Old and New TPH Data

While the use of the VPH/EPH approach is a preferred means to characterize risks from petroleum products released to the environment, there are significant amounts of historical Total Petroleum Hydrocarbon (TPH) data that have been obtained in the past for contaminated sites. Moreover, the future use of new TPH data may also be appropriate, to screen out problems in a cost-effective manner. For this reason, in addition to the VPH/EPH aliphatic and aromatic range standards, TPH reporting and cleanup standards have been retained in the Massachusetts Contingency Plan. Note, however, that many of the (post 1997 MCP) standards have been changed, in that the TPH standards are now set at the lowest EPH fractional standard (usually C11-C22 Aromatics), as a “worst case” assumption on hydrocarbon chemistry.

There are two ways to use TPH data:

- ◇ TPH data may be used *directly*, by comparison to TPH Reportable Concentrations and Cleanup Standards; or
- ◇ TPH data may be used *indirectly*, by using (conservative) assumptions on hydrocarbon chemistry to break down and “convert” the TPH data into aliphatic and aromatic ranges.

### 5.2.1 Comparing TPH Data to Reportable Concentrations, Method 1 Cleanup Standards, and UCLs

Soil and groundwater data obtained from a TPH test method may be directly used to ascertain reporting obligations, compliance with MCP Method 1 cleanup standards, and compliance with Upper Concentration Limits (UCLs). Because the TPH standards assume that the entire hydrocarbon mixture is comprised of the most toxic/problematic hydrocarbon fraction, in theory, use of TPH data would be viewed as a conservative screening effort. However, parties electing to proceed in such a fashion should be aware of the following practical conditions and concerns:

- ◇ Effective October 31, 1997, the MCP defines TPH as “the total or cumulative concentration of hydrocarbons with boiling points equal to or greater than 150°C (C9) and associated with a petroleum product...” All data termed TPH must meet this performance standard. Given the lack of standardized testing, calibration, and reporting techniques for TPH test methods, and methodological biases for techniques such as EPA Method 418.1 (Infra-red detection), demonstrating compliance with this definition is a burden that must be met by data users.
- ◇ In lieu of using an ill-defined TPH methodology, parties seeking to use this screening tool should consider using the EPH test method in the “TPH mode”. Specifically, the EPH method provides an option to forego the aliphatic/aromatic fractionation step, and generate a GC/FID TPH quantitation value. If this value is low, and below the TPH cleanup standard, compliance has been achieved. If this value is above the TPH cleanup standard, the laboratory can be instructed to then

proceed to the fractionation step, to produce more toxicologically relevant and less conservative fractional data.

- ◇ Because common TPH test techniques employ a solvent extraction and concentration step, which can lead to significant losses of hydrocarbons lighter than C9, the use of such methods are not appropriate in the characterization of light petroleum products, such as gasoline, aviation gasoline, and certain military jet fuels.
- ◇ Because the EPH fractional ranges provide a better characterization of hydrocarbon chemistry and risks, such data will take precedence over TPH data. For example, parties that exceed a TPH Method 1 cleanup standard have the option of obtaining EPH fractional range data, to see if the individual fractions comprising the TPH value are within listed standards. Similarly, under the provisions of 310 CMR 40.0360(2), parties that exceed a TPH Reportable Concentration have 120 days to obtain EPH fractional data, and demonstrate that NONE of the fractions exceeds an applicable Reportable Concentration, to avoid reporting.

### 5.2.2 Converting TPH Data into EPH Fractional Ranges

Since TPH is essentially a summation of the 3 EPH fractions (i.e., C9-C18 Aliphatics, C19-C36 Aliphatics, and C11-C22 Aromatics), it is possible to “convert” TPH data into the EPH fractional ranges, by making informed and reasonably conservative judgments on the chemistry of the TPH data. Compositional assumptions for soil data that are believed to be protective at most sites are provided in Table 5-1.

**Table 5-1: Recommended TPH Compositional Assumptions in Soil**

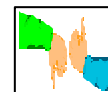

Petroleum Product	C11-C22 Aromatics	C9-C18 Aliphatics	C19-C36 Aliphatics
Diesel/#2/Crankcase Oil	60%	40%	0%
#3-#6 Fuel Oil	70%	30%	0%
Kerosene and Jet Fuel	30%	70%	0%
Mineral Oil Dielectric Fluid	20%	40%	40%
Unknown Oil	100%	0%	0%

For water data, only conservative assumptions can be made:

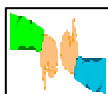

- ◇ For TPH water data, all of the TPH should be assumed to be the most conservative EPH fractional standard for the groundwater category(ies) of interest, although it is permissible to subtract out the concentrations of Target PAH analytes (e.g., naphthalene), if known;
- ◇ For Gasoline Range Organic (GRO) water data, the entire GRO concentration should be assumed to be the most conservative VPH fractional standard for the groundwater category(ies) of interest, although it is permissible to subtract out the concentration of Target BTEX/MtBE analytes, if known.

For old GRO soil data, a conservative assumption would be to consider all of the non-BTEX/MtBE hydrocarbons greater than C8 to be C9-C10 Aromatics. (All non-BTEX/MtBE compounds lighter than C9 are aliphatic hydrocarbons). **Note, however, that if the GRO soil sample was not preserved in methanol, the integrity and validity of this data would be suspect.**

In using and applying assumptions on the composition of petroleum hydrocarbons, it is essential that all relevant factors be carefully considered, including (1) level of certainty of identification of petroleum product(s) released at the site, (2) reliability, validity, and bias of TPH/screening techniques, and (3) sensitivity of pollutant receptors. Given the wide variability in “TPH” analytical methods, and inherent biases of these methods, the determination of a true TPH concentration is not a trivial exercise.

*When evaluating risks for Critical Exposure Pathways, such as drinking water wells, the use of assumptions is generally not appropriate, unless it can be demonstrated that such assumptions represent “worst case” conditions.*

### 5.3 VPH/EPH Compositional Variability/Recommended Approach

Because of fate and transport processes that act upon hydrocarbon compounds and mixtures when they are released to the environment, the chemical composition of petroleum contamination will vary across a site of concern. Accordingly, it is not possible to analyze one soil or groundwater sample by the VPH or EPH methods to establish a compositional template, and apply that template to break down TPH data from other parts of the site into aliphatic/aromatic fractional ranges. For example, soil in the saturated zone in the plume migration area will be contaminated with higher concentrations/proportions of more soluble compounds (e.g., aromatics); soils in older spill sites will have higher concentrations/proportions of less soluble/degradable compounds, such as heavy aliphatics and 3-5 ring PAH hydrocarbons.

For small sites, it may be more cost-effective to simply analyze all impacted media samples by VPH and/or EPH test methods, though use of field screening techniques would be desirable to optimize the selection and support the representativeness of such samples. For larger sites, however, cost savings may be realized by using a combination of VPH/EPH test methods and screening techniques to determine the nature and extent of contamination, and calculate Exposure Point Concentrations (EPCs). In such cases, the following would be recommended:

1. obtain VPH/EPH data from *key areas* and *exposure pathways*;
2. supplement VPH/EPH data with screening/TPH data;
3. consider the chemistry of the petroleum products released to the environment, fate and transport factors, the VPH/EPH data, and the conservative compositional parameters recommended in Table 5-1; and
4. determine conservative fractional composition/EPCs for risk assessment purposes and/or comparison with Method 1 standards.

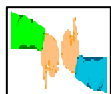

### 5.4 Other Program Issues

#### 5.4.1 Numerical Ranking System (NRS)

Under the provisions of 310 CMR 40.1500, sites are classified as either Tier I or Tier II on the basis of a numerical score, and scoring criteria are contained within a number of tables throughout this section. Recent additions to the MCP (1999) have provided (human) toxicity scoring criteria for the VPH/EPH fractions at 310 CMR 40.1511. Future revisions to the MCP will include additional VPH/EPH scoring criteria for mobility and persistence; until that occurs, scoring may be accomplished using the values listed in Table 5-2.

**Table 5-2: Mobility and Persistence Scoring Criteria for VPH/EPH Fractions**

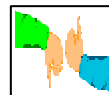

Fraction	Mobility and Persistence Values and Scores										
	Solubility (mg/L)		Vapor Press (mm Hg)		K <sub>ow</sub>		Degrad Potential		Specific Gravity		Total Score
	Value	Score	Value	Score	Value	Score	Value	Score	Value	Score	
C5-C8 Aliphatics	11	5	80	10	<E+04	5	NP	0	<1	0	20
C9-C12 Aliphatics	0.07	0	0.7	5	>E+04	0	NP	0	<1	0	5
C9-C10 Aromatics	51	5	2	10	<E+04	5	NP	0	<1	0	20
C9-C18 Aliphatics	0.01	0	0.2	5	>E+04	0	NP	0	<1	0	5
C19-C36 Aliphatics	N/A	0	N/A	0	N/A	0	P	10	<1	0	10
C11-C22 Aromatics	5.8	5	0.02	5	>E+04	0	NP	0	<1	0	10

#### **5.4.2 Characterization of Remediation Wastes**

For the purpose of characterizing Remediation Wastes, as well as other purposes, the sum of the 3 EPH fractions (i.e., C9-C18 Aliphatics, C19-C36 Aliphatics, and C11-C22 Aromatics) is equivalent to a TPH concentration, as defined by the MCP.

#### **5.4.3 Characterization of Remedial Air Emissions**

Requirements for the evaluation and/or treatment of remedial air emissions are specified in the MCP at 310 CMR 40.0049. Further guidance in this regard is provided in *Off-Gas Treatment of Point-Source Remedial Air Emissions*, Policy #WSC-94-150, available at <http://www.state.ma.us/dep/bwsc/finalpol.htm>

For the purposes of characterizing remedial air emissions at petroleum-contaminated sites, the following guidelines may be applied:

- The specification in 310 CMR 40.0049(5) to achieve 95% removal of emitted oil and hazardous materials applies to the collective concentrations of all influent/effluent hydrocarbons, not to individual target analytes and/or hydrocarbon ranges. Therefore, if monitored by the APH method, the collective concentration of all influent Target Analytes and hydrocarbon ranges is compared to the collective concentration of all effluent Target Analytes and hydrocarbon ranges.
- Consistent with the recommendations contained in Section 5.0 of *Off-Gas Treatment of Point-Source Remedial Air Emissions*, it is permissible to monitor influent and effluent vapor concentrations using a portable PID or FID unit. In such cases, the PID unit should be calibrated to an isobutylene response standard, and the FID unit should be calibrated to a methane response standard. At sites where gasoline vapors are being emitted, the PID must be equipped with a minimum 10.0 eV lamp. When using a PID or FID unit to monitor vapor emissions, a reading of 1 ppmV or less can generally be considered a "background" concentration.
- It is permissible to evaluate off-gas remedial emissions using the Emission-Distance Graphs contained in Section 7.3 of *Off-Gas Treatment of Point-Source Remedial Air Emissions*. When using these graphs, the C5-C8 Aliphatic, C9-C12 Aliphatic, and C9-C18 Aliphatic Hydrocarbon ranges are considered "Group 4" contaminants, and the C9-C10 Aromatic and C11-C22 Aromatic Hydrocarbon Fractions are considered "Group 3" contaminants.

#### **5.4.4 Characterization of Coal Tar Contaminated Sites**

MADEP is evaluating the applicability of the VPH/EPH approach in the characterization of sites contaminated by coal tars. As an interim recommendation, the use of VPH and EPH would appear to be an appropriate approach to characterize the risks posed by the aliphatic and aromatic hydrocarbons that comprise coal tars; because of the chemistry of this material, aliphatic and aromatic ranges quantitated by both the VPH and EPH methods would appear to be necessary, along with all method Target Analytes except MtBE (i.e., BTEX and the 17 Target PAHs). In addition to the aliphatic and aromatic ranges and Target Analytes, additional contaminants of concern for coal tars would include phenolics, cyanide, and trace metals.

**APPENDIX 1**  
**Collecting and Preserving VPH Samples**  
**Page 1 of 3**

**SOIL SAMPLES**

**OPTION 1: In-Field Methanol Preservation Technique**

**PERFORMANCE STANDARD:** Obtain undisturbed soil sample and immediately preserve with methanol at a ratio of 1 mL methanol per 1 gram soil (+/- 25%).

Step 1: Choose appropriate sampling container:

60 mL wide mouth packer bottle; or  
60 mL straight sided wide mouth bottle; or  
60 mL VOA vial; or  
40 mL VOA vial

All sampling containers should have an open-top screw cap with Teflon-coated silicone rubber septa or equivalent.

Step 2: Pre-label each container with a unique alpha/numerical designation. Obtain and record tare (empty) weight of each container to nearest 0.1 gram. *This information must be available to the laboratory performing the analyses.*

Step 3: Add 25 mLs of purge and trap grade methanol to 60 mL containers, or 15 mL to 40 mL containers. *It is essential that the methanol be purge and trap grade or equivalent quality.* Immediately cap the container. Make a mark on the 60 mL containers approximately 15 mL above the level of methanol, or a mark on the 40 mL container approximately 10 mL above the level of methanol. The objective is to obtain 25 grams of soil in the 60 mL container, or 15 grams of soil in the 40 mL container, which is approximately 15 and 10 mL of soil volume, respectively, depending upon soil type and moisture content. Other masses of soil are permissible, as long as the ratio of [grams soil]/[mL methanol] is 1:1, +/- 25%. Store at 4°C. *The use of a methanol trip blank prepared in this manner is recommended.*

Step 4: In the field, carefully add soil to the sample container, until the level of methanol in the vial reaches the designated volumetric mark. For wet soil, add slightly beyond the mark. **IN NO CASE, HOWEVER, MAY THE LEVEL OF SOIL IN THE CONTAINER RISE ABOVE THE LEVEL OF METHANOL.** The use of a 10-30 mL disposable syringe with the end cut off is recommended to obtain an undisturbed soil sample from freshly exposed soils. In such cases, obtain and extrude the soil into sample container, avoiding splashing methanol out of the container.

*Optional: use a field electronic balance to ensure addition of desired mass of soil (25 grams to 60 mL containers, 15 grams to 40 mL containers).*

Step 5: Use a clean brush or paper towel to remove soil particles from the threads of the sample container and screw cap. Tightly apply and secure screw cap. Gently swirl sample to break up soil aggregate, if necessary, until soil is covered with methanol. **DO NOT SHAKE.** Duplicate samples obtained in this manner are recommended. A split-sample must also be obtained for a determination of soil moisture content. This sample must NOT be preserved in methanol. **HINT:** fill this container 1/2 full, to allow screening of the sample headspace by the field investigator or the laboratory.

Step 6: Immediately place containers in cooler for storage in an upright position. Sample vials may be placed in separate sealable bags to protect containers in case of leakage during transport. Transport to analytical laboratory using appropriate chain-of-custody procedures and forms.

**APPENDIX 1**  
**Collecting and Preserving VPH Samples**  
**Page 2 of 3**

**SOIL SAMPLES (Continued)**

**OPTION 2: Use of a Sealed-Tube Sampling/Storage Device**

**PERFORMANCE STANDARD:**      **Obtain undisturbed soil sample and immediately seal in air-tight container, for shipment to laboratory and immersion in methanol within 48 hours.**

Step 1:                      Obtain pre-cleaned and/or disposable samplers/containers that allow the collection and air-tight storage of 5- 25 grams of soil.

Step 2:                      In the field, obtain an undisturbed sample from freshly exposed soil. Immediately seal container, and place in a cooler. Obtain a duplicate sample to enable the determination of soil moisture content (this may be stored/sealed in a conventional container). Transport to analytical laboratory using appropriate chain-of-custody procedures and forms.

Step 3:                      Samples must be extruded and immersed in purge and trap (or equivalent) grade methanol at the laboratory within 48 hours of sampling, at a ratio of 1 mL methanol to 1 gram soil. In no case, however, shall the level of soil in the laboratory container exceed the level of methanol (i.e., the soil must be completely immersed in methanol).

*NOTE: Documentation MUST be provided/available on the ability of the sampler/container to provide an air-tight seal in a manner that results in no statistically significant loss of volatile hydrocarbons for at least 48 hours.*

**OPTION 3: Use of Alternative Collection/Storage/Preservation Techniques**

**PERFORMANCE STANDARD:**      **Obtain and store an undisturbed soil sample in a manner that ensures the chemical integrity of the sample by (1) preventing the volatilization of petroleum hydrocarbons heavier than C5, and (2) preventing the biological degradation of petroleum hydrocarbons.**

*NOTE: The onus is on the user of such techniques to demonstrate the validity of the procedures used, via reference to published literature and/or other pertinent data.*

**SAFETY**

*Methanol is a toxic and flammable liquid, and must be handled with appropriate care. Use in a well-vented area, and avoid inhaling methanol vapors. The use of protective gloves is recommended when handling or transferring methanol. Vials of methanol should always be stored in a cooler with ice at all times, away from sources of ignition such as extreme heat or open flames.*

**APPENDIX 1**  
**Collecting and Preserving VPH Samples**  
**Page 3 of 3**

**AQUEOUS SAMPLES**

**MOST VPH/VOC AQUEOUS SAMPLES**

All aqueous samples that will not be analyzed within 4 hours of collection must be preserved by pH adjustment, in order to minimize analyte losses due to biodegradation. For most samples, this can be accomplished by acidification of the sample to pH <2, by adding 3-4 drops of 1:1 HCl to a 40 mL vial. The sample should then be stored at 4°C until it is analyzed. In lieu of acidification, samples may also be preserved with an appropriate base to pH > 11.0 (see below).

**SAMPLES TO BE ANALYZED FOR MtBE**

**ISSUE**

Traditionally, VPH and VOC aqueous samples have been preserved by addition of an acid (e.g., HCl) to lower the pH of the sample to less than 2.0. While this is still an acceptable approach for petroleum hydrocarbons and most VOC analytes, recent information and data have indicated that such a technique can lead to significant losses (up to 89%) of MtBE and other ethers (White, H., Lesnik, B., Wilson, J., *Analytical Methods for Fuel Oxygenates*, LUSTLINE Bulletin #42, New England Interstate Water Pollution Control Commission, 2002 (<http://www.epa.gov/swerust1/mtbe/LL42Analytical.pdf>)). Specifically, the combination of a low pH and high temperature sample preparation technique (e.g., heated purge and trap) hydrolyze the ether bonds present in the sample, converting the ethers into alcohols (e.g., TBA).

**PRESERVING  
MtBE  
SAMPLES**

To prevent ether hydrolysis, samples should either (a) not be acidified or (b) not be heated. Because heating the sample may be necessary to achieve proper analyte purging/partitioning, an alternative to acidification is likely to be the most efficient means to prevent hydrolysis. Because ethers are not subject to base-catalyzed hydrolysis, raising the pH of the sample is an acceptable alternative to acidification. Studies by the USEPA have shown that preservation of aqueous samples to a pH greater than 11.0 using trisodium phosphate dodecahydrate will effectively prevent biological degradation of dissolved analytes, and will not result in deleterious effects on other dissolved oxygenates or on BTEX analytes.

**PROTOCOL**

A recommended protocol to achieve a pH level > 11.0 is to add between 0.40 and 0.44 grams of trisodium phosphate dodecahydrate to a 40 mL vial. For convenience, this can be done in the laboratory prior to sample collection in the field. Because it is more convenient to measure the required amount of trisodium phosphate dodecahydrate on a volume basis rather than by weight, the use of a precalibrated spoon is recommended. In the field, each vial is filled with the aqueous sample and sealed without headspace – as is traditionally done for acidified samples. The sample is then stored at 4°C until it is analyzed.

**WHEN IS  
THIS  
NEEDED?**

Given the Method 1 standard for MtBE in GW-2 and GW-3 areas (i.e., 50,000 µg/L), MADEP will generally not expect or require the use of alternative preservation or analytical protocols for disposal sites located ONLY in such areas, with respect to demonstrating attainment of a condition of No Significant Risk. Nevertheless, such efforts should be considered, and may be necessary, on a case-specific basis, to investigate other site assessment objectives, such as extent of contamination, source identification, etc.

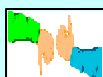

For gasoline releases in GW-1 areas, it is generally expected that some level of assessment will be conducted to confirm the concentration of MtBE using alternative preservation and/or analytical procedures to prevent hydrolysis of ethers. In particular, confirmatory samples would be recommended in the “source area” and in the outer plume (or N.D.) monitoring wells. When sampling a private or public drinking water supply well that is proximate to a release of gasoline and/or #2 fuel oil, it is generally expected that all such samples will be evaluated for the presence of MtBE by use of an alternative preservation and/or analytical procedure.



## APPENDIX 2 SHIPPING METHANOL PRESERVED SAMPLES

### Shipping of Hazardous Materials

Methanol is considered a hazardous material by the US Department of Transportation (DOT) and the International Air Transport Association (IATA). Shipments of methanol between the field and the laboratory must conform to the rules established in Title 49 of the Code of Federal Regulations (49 CFR parts 171 to 179), and the most current edition of the IATA Dangerous Goods Regulations. Consult these documents or your shipping company for complete details, as these regulations may change without notice.

### Small Quantity Exemption

The volumes of methanol recommended in the VPH method fall under the small quantity exemption of 49 CFR section 173.4. To qualify for this exemption, all of the following must be met:

- ◇ the maximum volume of methanol in each sample container must not exceed 30 mL
- ◇ the sample container must not be full of methanol
- ◇ the sample container must be securely packed and cushioned in an upright position, and be surrounded by a sorbent material capable of absorbing spills from leaks or breakage of sample containers
- ◇ the package weight must not exceed 64 pounds
- ◇ the volume of methanol per shipping container must not exceed 500 mL
- ◇ the packaging and shipping container must be strong enough to hold up to the intended use
- ◇ the package must not be opened or altered while in transit
- ◇ the shipper must mark the shipping container in accordance with shipping dangerous goods in acceptable quantities, and provide the statement:

*“This package conforms to conditions and limitations specified in 49 CFR 173.4”*

### Shipping Papers

All shipments must be accompanied by shipping papers that include the following:

Proper Shipping Name:	Methyl Alcohol
Hazardous Class:	Flammable Liquid
Identification Number:	UN1230
Total Quantity:	<i>(mL methanol/container x the number of containers)</i>
Emergency Response Info:	Methanol MSDS attached
Emergency Response Phone:	<i>provide appropriate number</i>
Shipping Exemption:	DOT-E 173.118, Limited Quantity

### Labeling & Placarding

Labeling and placarding are not required for valid small quantity exemptions (per 173.118)

## APPENDIX 3 - Required VPH Data Report Content

### SAMPLE INFORMATION

<b>Matrix</b>	<input type="checkbox"/> Aqueous <input type="checkbox"/> Soil <input type="checkbox"/> Sediment <input type="checkbox"/> Other:		
<b>Containers</b>	<input type="checkbox"/> Satisfactory <input type="checkbox"/> Broken <input type="checkbox"/> Leaking:		
<b>Sample Preservatives</b>	Aqueous	<input type="checkbox"/> N/A <input type="checkbox"/> pH<2 <input type="checkbox"/> pH>2 Comment:	
	Soil or Sediment	<input type="checkbox"/> N/A <input type="checkbox"/> Samples NOT preserved in Methanol or air-tight container	
		<input type="checkbox"/> Samples rec'd in Methanol: <input type="checkbox"/> covering soil <input type="checkbox"/> not covering soil	
	<input type="checkbox"/> Samples received in air-tight container:		mL Methanol/g soil <input type="checkbox"/> 1:1 +/- 25% <input type="checkbox"/> Other:
<b>Temperature</b>	<input type="checkbox"/> Received on Ice <input type="checkbox"/> Received at 4 °C <input type="checkbox"/> Other:		

### VPH ANALYTICAL RESULTS

Method for Ranges: MADEP VPH 98-1		Client ID						
Method for Target Analytes:		Lab ID						
VPH Surrogate Standards		Date Collected						
PID:		Date Received						
FID:		Date Analyzed						
		Dilution Factor						
		% Moisture (soil)						
<b>Range/Target Analyte</b>	<b>Elution Range</b>	<b>RL</b>	<b>Units</b>					
Unadjusted C5-C8 Aliphatics <sup>1</sup>	N/A							
Unadjusted C9-C12 Aliphatics <sup>1</sup>	N/A							
Benzene								
Ethylbenzene								
Methyl-tert-butylether								
Naphthalene	N/A							
Toluene								
m- & p- Xylenes								
o-Xylene								
C5-C8 Aliphatic Hydrocarbons <sup>1,2</sup>	N/A							
C9-C12 Aliphatic Hydrocarbons <sup>1,3</sup>	N/A							
C9-C10 Aromatic Hydrocarbons <sup>1</sup>	N/A							
PID Surrogate % Recovery								
FID Surrogate % Recovery								
Surrogate Acceptance Range				70-130%	70-130%	70-130%	70-130%	70-130%

<sup>1</sup>Hydrocarbon Range data exclude concentrations of any surrogate(s) and/or internal standards eluting in that range  
<sup>2</sup> C<sub>5</sub>-C<sub>8</sub> Aliphatic Hydrocarbons exclude the concentration of Target Analytes eluting in that range  
<sup>3</sup> C<sub>9</sub>-C<sub>12</sub> Aliphatic Hydrocarbons exclude conc of Target Analytes eluting in that range AND concentration of C<sub>9</sub>-C<sub>10</sub> Aromatic Hydrocarbons

### CERTIFICATION

Were all QA/QC procedures REQUIRED by the VPH Method followed?	<input type="checkbox"/> Yes <input type="checkbox"/> No - Details Attached
Were all performance/acceptance standards for required QA/QC procedures achieved?	<input type="checkbox"/> Yes <input type="checkbox"/> No - Details Attached
Were any significant modifications made to the VPH method, as specified in Sect 11.3?	<input type="checkbox"/> No <input type="checkbox"/> Yes - Details Attached
<i>I attest under the pains and penalties of perjury that, based upon my inquiry of those individuals immediately responsible for obtaining the information, the material contained in this report is, to the best of my knowledge and belief, accurate and complete.</i>	
SIGNATURE: _____	POSITION: _____
PRINTED NAME: _____	DATE: _____

**APPENDIX 3 - Supplemental VPH QA/QC data (Optional)**

**QA/QC DATA**

Range/Target Analyte	Range of Elution	Reporting Limit	Lab Method Blank	Duplicate Sample			Lab Fortified Blank	
				Sample	Duplicate	%RPD	Spiking Conc	% Recov
Unadjusted C5-C8 Aliphatics	N/A						N/A	N/A
Unadjusted C9-C12 Aliphatics	N/A						N/A	N/A
Pentane								
2-Methylpentane								
Methyl-t-butylether								
2,2,4-Trimethylpentane								
Benzene								
Toluene								
n-Nonane								
Ethylbenzene								
m- & p- Xylenes								
Naphthalene								
C5-C8 Aliphatics Hydrocarbons	N/A						N/A	N/A
C9-C12 Aliphatics Hydrocarbons	N/A						N/A	N/A
C9-C10 Aromatics Hydrocarbons	N/A						N/A	N/A
Sample Matrix								
Units								
Sample ID number		N/A						
Date Analyzed		N/A						

**VPH SOIL PRESERVATION DATA**

	<b>Client ID</b>									
	<b>Lab ID</b>									
<b>A</b>	<b>Tare Wt. Jar (g)</b>									
<b>B</b>	<b>Vol Methanol Initially Added (mL)</b>									
<b>C</b>	<b>Wt. Jar &amp; Methanol (g)</b>									
<b>D</b>	<b>Wt Jar, Methanol &amp; Soil (g)</b>									
<b>D-C</b>	<b>Wt. Soil (g)</b>									
<b>E</b>	<b>Est Vol loss Methanol after sampling (mL)</b>									
<b>F</b>	<b>Vol Methanol added after sampling (mL)</b>									
<b>B-E+F</b>	<b>Final Vol Methanol Preservative (mL)</b>									
<b>G</b>	<b>Vol Surrogates/Internal Stds Added (mL)</b>									
<b>H</b>	<b>Volume of Matrix Spikes Added (mL)</b>									

## APPENDIX 3 – Required EPH Data Report Content

### SAMPLE INFORMATION

<b>Matrix</b>	<input type="checkbox"/> Aqueous <input type="checkbox"/> Soil <input type="checkbox"/> Sediment <input type="checkbox"/> Other:
<b>Containers</b>	<input type="checkbox"/> Satisfactory <input type="checkbox"/> Broken <input type="checkbox"/> Leaking:
<b>Aqueous Preservatives</b>	<input type="checkbox"/> N/A <input type="checkbox"/> pH $\leq$ 2 <input type="checkbox"/> pH>2   Comment:
<b>Temperature</b>	<input type="checkbox"/> Received on Ice <input type="checkbox"/> Received at 4 ° C <input type="checkbox"/> Other:
<b>Extraction Method</b>	Water: _____ Soil: _____

### EPH ANALYTICAL RESULTS

Method for Ranges: MADEP EPH 98-1	Client ID					
Method for Target Analytes:	Lab ID					
EPH Surrogate Standards Aliphatic: Aromatic:	Date Collected					
	Date Received					
	Date Extracted					
EPH Fractionation Surrogates	Date Analyzed					
	Dilution Factor					
	% Moisture (soil)					
RANGE/TARGET ANALYTE	RL	Units				
Unadjusted C11-C22 Aromatics <sup>1</sup>						
Diesel PAH Analytes	Naphthalene					
	2-Methylnaphthalene					
	Phenanthrene					
	Acenaphthene					
Other Target PAH Analytes						
C9-C18 Aliphatic Hydrocarbons <sup>1</sup>						
C19-C36 Aliphatic Hydrocarbons <sup>1</sup>						
C11-C22 Aromatic Hydrocarbons <sup>1,2</sup>						
Aliphatic Surrogate % Recovery						
Aromatic Surrogate % Recovery						
Sample Surrogate Acceptance Range			40-140%	40-140%	40-140%	40-140%
Fractionation Surrogate % Recovery						
Fractionation Surrogate % Recovery						
Fractionation Surrogate Acceptance Range			40-140%	40-140%	40-140%	40-140%

<sup>1</sup>Hydrocarbon Range data exclude concentrations of any surrogate(s) and/or internal standards eluting in that range

<sup>2</sup> C11-C22 Aromatic Hydrocarbons exclude the concentration of Target PAH Analytes

### CERTIFICATION

Were all QA/QC procedures <b>REQUIRED</b> by the EPH Method followed?	<input type="checkbox"/> Yes <input type="checkbox"/> No-Details Attached
Were all performance/acceptance standards for the required QA/QC procedures achieved?	<input type="checkbox"/> Yes <input type="checkbox"/> No-Details Attached
Were any significant modifications made to the EPH method, as specified in Section 11.3?	<input type="checkbox"/> No <input type="checkbox"/> Yes-Details Attached
<i>I attest under the pains and penalties of perjury that, based upon my inquiry of those individuals immediately responsible for obtaining the information, the material contained in this report is, to the best of my knowledge and belief, accurate and complete.</i>	
SIGNATURE: _____	POSITION: _____
PRINTED NAME: _____	DATE: _____

## APPENDIX 3 - Recommended TPH Data Report Content

### SAMPLE INFORMATION

Matrix	<input type="checkbox"/> Aqueous <input type="checkbox"/> Soil <input type="checkbox"/> Sediment <input type="checkbox"/> Other:
Containers	<input type="checkbox"/> Satisfactory <input type="checkbox"/> Broken <input type="checkbox"/> Leaking:
Aqueous Preservatives	<input type="checkbox"/> N/A <input type="checkbox"/> pH $\leq$ 2 <input type="checkbox"/> pH $>$ 2   Comment:
Temperature	<input type="checkbox"/> Received on Ice <input type="checkbox"/> Received at 4 ° C <input type="checkbox"/> Other:
Extraction Method	Water: _____ Soil: _____

### TPH ANALYTICAL RESULTS

Method: MADEP EPH 98-1		Client ID						
Method for Target Analytes:		Lab ID						
TPH Surrogate Standards		Date Collected						
		Date Received						
		Date Extracted						
		Date Analyzed						
		Dilution Factor						
		% Moisture (soil)						
Range/Target Analyte		RL	Units					
Unadjusted Total Petroleum Hydrocarbons <sup>1</sup>								
Diesel PAH Analytes	Naphthalene							
	2-Methylnaphthalene							
	Phenanthrene							
	Acenaphthene							
Other PAH Target Analytes								
Total Petroleum Hydrocarbons <sup>2</sup>								
Sample Surrogate % Recovery								
Sample Surrogate Acceptance Range				40-140%	40-140%	40-140%	40-140%	40-140%
<sup>1</sup> Hydrocarbon Range data exclude concentrations of any surrogate(s) and/or internal standards eluting in that range <sup>2</sup> Total Petroleum Hydrocarbons exclude the concentration of PAH Target Analytes								

### CERTIFICATION

Were all QA/QC procedures REQUIRED by the EPH Method (for TPH) followed?	<input type="checkbox"/> Yes <input type="checkbox"/> No-Details Attached
Were all performance/acceptance standards for the required QA/QC procedures achieved?	<input type="checkbox"/> Yes <input type="checkbox"/> No-Details Attached
Were any significant modifications made to the EPH method, as specified in Section 11.3?	<input type="checkbox"/> No <input type="checkbox"/> Yes-Details Attached
<i>I attest under the pains and penalties of perjury that, based upon my inquiry of those individuals immediately responsible for obtaining the information, the material contained in this report is, to the best of my knowledge and belief, accurate and complete.</i>	
SIGNATURE: _____	POSITION: _____
PRINTED NAME: _____	DATE: _____



**APPENDIX 4 - VPH/EPH Cleanup Standards and Reportable Concentrations**  
**October 31, 1997**

**Reportable Concentrations**

Fraction/Parameter	RCS-1 (mg/g)	RCS-2 (mg/g)	RCGW-1 (mg/L)	RCGW-2 (mg/L)
C5-C8 Aliphatic Hydrocarbons	100	500	400	1000
C9-C12 Aliphatic Hydrocarbons	1000	2500	1000	1000
C9-C10 Aromatic Hydrocarbons	100	500	200	4000
C9-C18 Aliphatic Hydrocarbons	1000	2500	1000	1000
C19-C36 Aliphatic Hydrocarbons	2500	5000	5000	20,000
C11-C22 Aromatic Hydrocarbons	200	2000	2000	30,000
Total Petroleum Hydrocarbons (TPH)	200	2000	2000	1000

**Method 1 Cleanup Standards for Groundwater**

Fraction/Parameter	GW-1 (mg/L)	GW-2 (mg/L)	GW-3 (mg/L)
C5-C8 Aliphatic Hydrocarbons	400	1000	4000
C9-C12 Aliphatic Hydrocarbons	4000	1000	20,000
C9-C10 Aromatic Hydrocarbons	200	5000	4000
C9-C18 Aliphatic Hydrocarbons	4000	1000	20,000
C19-C36 Aliphatic Hydrocarbons	5000	N/A	20,000
C11-C22 Aromatic Hydrocarbons	200	50,000	30,000
Total Petroleum Hydrocarbons (TPH)	200	1000	20,000

**Method 1 Cleanup Standards for Soil**

Fraction/Parameter	GW-1 Areas			GW-2 Areas			GW-3 Areas		
	S-1 (mg/g)	S-2 (mg/g)	S-3 (mg/g)	S-1 (mg/g)	S-2 (mg/g)	S-3 (mg/g)	S-1 (mg/g)	S-2 (mg/g)	S-3 (mg/g)
C5-C8 Aliphatic Hydrocarbons	100	500	500	100	500	500	100	500	500
C9-C12 Aliphatic Hydrocarbons	1000	2500	5000	1000	2500	5000	1000	2500	5000
C9-C10 Aromatic Hydrocarbons	100	100	100	100	500	500	100	500	500
C9-C18 Aliphatic Hydrocarbons	1000	2500	5000	1000	2500	5000	1000	2500	5000
C19-C36 Aliphatic Hydrocarbons	2500	5000	5000	2500	5000	5000	2500	5000	5000
C11-C22 Aromatic Hydrocarbons	200	200	200	800	2000	5000	800	2000	5000
Total Petroleum Hydrocarbons (TPH)	200	200	200	800	2000	5000	800	2000	5000

**Upper Concentration Limits (UCLs)**

Fraction/Parameter	Groundwater (mg/L)	Soil (mg/g)
C5-C8 Aliphatic Hydrocarbons	100,000	5000
C9-C12 Aliphatic Hydrocarbons	100,000	20,000
C9-C10 Aromatic Hydrocarbons	100,000	5000
C9-C18 Aliphatic Hydrocarbons	100,000	20,000
C19-C36 Aliphatic Hydrocarbons	100,000	20,000
C11-C22 Aromatic Hydrocarbons	100,000	10,000
Total Petroleum Hydrocarbons (TPH)	100,000	10,000

**Cleanup Standards are subject to change; consult latest version of the MCP for most up to date values!**

## APPENDIX 5 - ADDITIONAL REFERENCE/SUPPORT MATERIALS



### For a Closer Look.....

The following documents and publications provided additional background, information, and insight into the VPH/EPH approach, guidance, and standards

### MADEP Publications

#### VPH/EPH Approach

- ◇ *Interim Final Petroleum Report: Development of Health-Based Alternative to the Total Petroleum Hydrocarbon (TPH) Parameter, August, 1994* - Original report presenting the toxicological basis of the proposed new VPH/EPH approach.
- ◇ *Issues Paper: Implementation of VPH/EPH Approach, Public Comment Draft, May, 1996* - Detailed discussion and recommendations on how to develop MCP Method 1 cleanup standards, and otherwise incorporate new VPH/EPH approach into the MCP regulatory process.
- ◇ *Beyond TPH: Understanding and Using the New VPH/EPH Approach, June, 1997* - Slides and handouts from a day-long training session presented by MADEP in the Spring of 1997.
- ◇ *#2 Fuel/Diesel Short Form, July, 2002* - An Excel spreadsheet that allows for the site-specific characterization of human health risks for Target Analytes and appropriate aliphatic/aromatic hydrocarbon fractions.
- ◇ *Reports on the Results of the VPH/EPH Round Robin Testing Programs, June 1997 and January 1998* - Detailed reports outlining the methods and results of two interlaboratory "Round Robin" testing programs undertaken by MADEP to help refine and validate the VPH and EPH analytical test methods.
- ◇ *Method for the Determination of Volatile Petroleum Hydrocarbons (VPH), January, 1998* - Detailed analytical procedure for this GC/PID/FID methodology developed by MADEP.
- ◇ *Method for the Determination of Extractable Petroleum Hydrocarbons (EPH), January, 1998* - Detailed analytical procedure for this silica-gel/fractionation GC/FID method developed by MADEP.
- ◇ *Draft Method for the Determination of Air-Phase Petroleum Hydrocarbons (APH), February, 2000* - Proposed analytical procedure for this GC/MS methodology developed by MADEP.
- ◇ *Background Documentation for the Development of VPH/EPH Cleanup Standards and Guidance, October, 2002*, available at [http://www.state.ma.us/dep/bwsc/vph\\_eph.htm](http://www.state.ma.us/dep/bwsc/vph_eph.htm)

#### Related MADEP Regulations and Guidance Documents

- ◇ *Massachusetts Contingency Plan (MCP), 310 CMR 40.0000* - State regulations that govern the cleanup of sites contaminated by oil or hazardous materials; now includes provisions for VPH/EPH approach and standards.
- ◇ *Background Documentation for the Development of the MCP Numerical Standards, April, 1994* - Contains information, data, assumptions, approaches, and spreadsheets for development of the MCP Method 1 cleanup standards, excluding VPH/EPH fractional range standards.
- ◇ *Guidance for Disposal Site Risk Characterization in Support of the Massachusetts Contingency Plan, July, 1995* - Comprehensive guidance on how to characterize risks to human and ecological receptors.



## APPENDIX 5 - ADDITIONAL REFERENCE/SUPPORT MATERIALS (continued)

### Related MADEP Regulations and Guidance Documents (continued)

- ◇ *Commonwealth of Massachusetts Underground Storage Tank Closure Assessment Manual, April, 1996* - Outlines requirements and procedures for conducting a closure assessment of underground storage tanks.
- ◇ *Interim Remediation Waste Management Policy for Petroleum Contaminated Soils, April, 1994* - Procedures, requirements, and recommendations for characterizing, classifying, managing, and recycling/disposing of petroleum contaminated soils.

All MADEP publications available on the World Wide Web at <http://www.state.ma.us/dep/bwsc/pubs.htm>

### Total Petroleum Hydrocarbon Criteria Working Group (TPHCWG) Publications

TPHCWG is a national consortium of state regulatory agencies, academia, DOD, DOE, USEPA, ASTDR, petroleum, power and transportation industries, and consulting firms. The goal of this group is to evaluate and propose methods to characterize risks posed by petroleum-contaminated media. TPHCWG has endorsed a toxicological approach similar to the MADEP VPH/EPH approach. Recommendations by this group on evaluating the fate and transport of aliphatic and aromatic hydrocarbon fractions were used by MADEP in developing the cleanup standards and the guidelines and recommendations contained in this policy. TPHCWG plans on publishing a six-volume series of reports on issues of interest; volumes of interest to parties using the VPH/EPH approach are listed below:

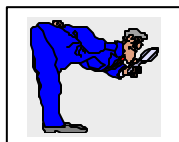

- ◇ *Volume I – Analysis of Petroleum Hydrocarbons in Environmental Media (1998)* - Contains an overview of petroleum hydrocarbon characterization and risk assessment, a discussion of available analytical methods, and a proposed GC-Based analytical method, developed by the Working group, that reports hydrocarbon results in equivalent carbon number groups or fractions.
- ◇ *Volume II - Composition of Petroleum Mixtures* – Contains a description of the chemical characteristics and composition of petroleum fuels, with a comprehensive series of tables and references.
- ◇ *Volume III - Selection of TPH Fractions Based upon Fate and Transport Consideration (1997)*- Contains information and data on the physical and chemical properties of hydrocarbons and hydrocarbon mixtures, and recommended algorithms for determining the properties of aliphatic and aromatic fractions.
- ◇ *Volume IV - Development of Fraction-Specific Reference Doses (RfDs) and Reference Concentrations (RfCs) for Total Petroleum Hydrocarbons (TPH (1997)* - Contains extensive information and data on the toxicological properties of petroleum products and hydrocarbon mixtures, and a proposed approach to characterize risks based upon the collective fractions of aliphatic and aromatic fractions. NOTE: Certain provisions of these recommendations are in conflict with current MADEP positions and requirement, although the agency is currently evaluating recent data presented in this volume.

**TPHCWG Publications are being cited as potentially relevant background/reference materials. MADEP is not necessarily endorsing the conclusions and/or recommendations provided in these various documents.**

**TPHCWG Publications available on the World Wide Web at**  
<http://www.aehs.com/publications/catalog/contents/tph.htm>

**APPENDIX 6**  
**SUMMARY OF SIGNIFICANT CHANGES MADE TO FINAL IMPLEMENTATION POLICY**

<b>BY SECTION</b>		
<b>Section</b>	<b>Subject</b>	<b>Change/Addition</b>
1.3	Applicability	New explanation of VPH/EPH reporting obligations at closed sites
3.2.3	APH	New explanation of Air-Phase Petroleum Hydrocarbon (APH) method
3.5	Method Modification	New guidance on evaluating modifications to VPH/EPH/APH procedures
3.7	Other Testing Methods	New guidance on use of TPH and other hydrocarbon testing procedures
4.1	Exposure Point Conc.	New Section 4.1 added with additional guidance on determining EPCs
4.2.2	Target Analytes	<b>Modifications of Table 43, additional information and guidance on lead, EDB, MtBE, and other petroleum additives</b>
4.3	Vapor Pathway	Expanded “tool box” approach to investigate (Figure 4-1) and mitigate (Figure 4-3) subsurface vapor infiltration pathways
4.3.1	Soil Gas Screening	Additional guidance on location of soil gas probes; <b>new criteria for PID/FID Level 1 Screening (Table 4-9)</b> ; additional guidance on Level 2 Screening
4.3.1.1	Soil Gas Guidelines	Certain Target Analytes added to Tables 4-9, 4-10, and 4-11; criteria now relevant to soil contamination, as well as GW -2 exceedances
4.3.1.4	Vapor Transport Models	New reference to DEP policy on use/utility of transport models
4.3.1.5	Groundwater Profiling	New guidance on evaluating indoor air pathways by profiling contaminant concentrations at and below the groundwater table
4.3.2	GW -3 Evaluation	<b>New Dilution Graphs (Figure 4-4) and guidance to evaluate plume dispersion</b>
4.5	Toxicological parameters	<b>New RfD and RfC values for certain fractions</b>
4.6	Fate/Transport Parameters	New aqueous diffusivity coefficients for hydrocarbon fractions
4.7	NAPL	Additional guidance on NAPL monitoring and evaluation
5.4.1	NRS	New recommended mobility and persistence scoring criteria (Table 5-2) for hydrocarbon fractions when using Numerical Ranking System
5.4.3	Remedial Air Emissions	<b>New recommendations on monitoring and evaluating off-gas treatment for remedial air emissions</b>
App 1	MtBE analysis	<b>New information/guidelines on preservation of aqueous samples for MtBE analysis (Due to degradation caused by acidification)</b>
App 3	VPH/EPH Report Format	Required Reporting Format for VPH/EPH methods
App 5	References	Additional references/support materials for VPH/EPH approach

**Shading indicates changes that were made AFTER issuance of FINAL DRAFT document (June 2001)**

**APPENDIX 6**  
**SUMMARY OF SIGNIFICANT CHANGES MADE TO FINAL IMPLEMENTATION POLICY**  
**(Continued)**

<b>BY SUBJECT</b>		
<b>Subject</b>	<b>Section</b>	<b>Change/Addition</b>
APH	3.2.3	New explanation of Air-Phase Petroleum Hydrocarbon (APH) method
Applicability	1.3	New explanation of VPH/EPH reporting obligations at closed sites
Exposure Point Conc.	4.1	New Section 4.1 added with additional guidance on determining EPCs
Fate/Transport Parameters	4.6	New aqueous diffusivity coefficients for hydrocarbon fractions
Groundwater Profiling	4.3.1.5	New guidance on evaluating indoor air pathways by profiling contaminant concentrations at and below the groundwater table
GW -3 Evaluations	4.3.2	<b>New Dilution Graphs (Figure 4-4) and guidance to evaluate plume dispersion</b>
Method Modifications	3.5	New guidance on evaluating modifications to VPH/EPH/APH procedures
MtBE analysis	App 1	<b>New information/guidelines on preservation of aqueous samples for MtBE analysis (Due to degradation caused by acidification)</b>
NAPL	4.7	Additional guidance on NAPL monitoring and evaluation
NRS	5.4.1	New recommended mobility and persistence scoring criteria (Table 5-2) for hydrocarbon fractions when using Numerical Ranking System
Other Testing Methods	3.7	New guidance on use of TPH and other hydrocarbon testing procedures
References	App5	Additional references/support materials for VPH/EPH approach
Remedial Air Emissions	5.4.3	<b>New recommendations on monitoring and evaluating off-gas treatment for remedial air emissions</b>
Soil Gas Screening	4.3.1	Additional guidance on location of soil gas probes; <b>new criteria for PID/FID Level 1 Screening (Table 4-9)</b> ; additional guidance on Level 2 Screening
Soil Gas Guidelines	4.3.1.1	Certain Target Analytes added to Table 4-9, 4-10, and 4-11; criteria now relevant to soil contamination, as well as GW -2 exceedances
Target Analytes	4.2.2	<b>Modifications of Table 43, additional information and guidance on lead, EDB, MtBE, and other petroleum additives</b>
Toxicological Parameters	4.5	<b>New RfD and RfC values for certain fractions</b>
Vapor Pathway	4.3	Expanded “tool box” approach to investigate (Figure 4-1) and mitigate (Figure 4-3) subsurface vapor infiltration pathways
Vapor Transport Models	4.3.1.4	New reference to DEP policy on use/utility of transport models
VPH/EPH Report Format	App3	Required Reporting Format for VPH/EPH methods

**Shading indicates changes that were made AFTER issuance of FINAL DRAFT document (June 2001)**

## **Overview of Gasoline Composition (NEIWPCC, 2003)**

# L.U.S.T.LINE

A Report On Federal & State Programs To Control Leaking Underground Storage Tanks

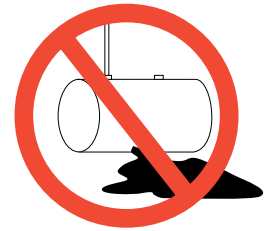

## A **Hot Dog** by Any Other Name Could Be Your Drinking Water

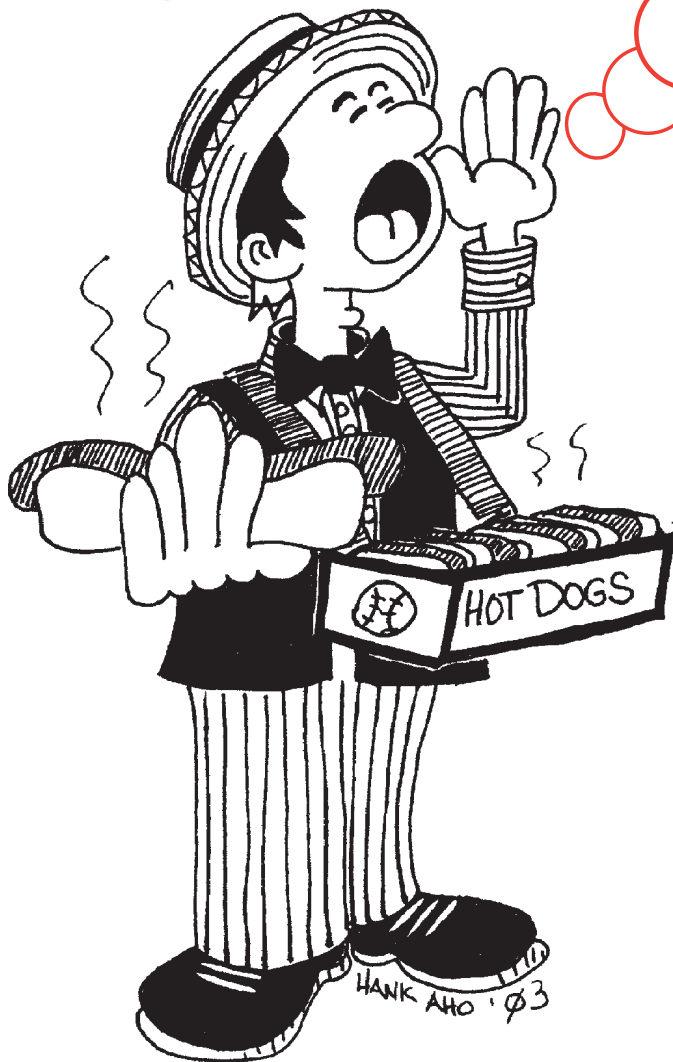

by Patricia Ellis

**"Hot dogs, getcher hot dogs!"**

The cry of the hot dog vendor at the ballpark. The steaming hot frank with your choice of mustard, ketchup, relish...the captivating aroma and the even more satisfying taste! But let's not stop to think about what's actually in a hot dog. Sure, some of us take comfort in consuming only hot dogs that are "all beef" or "chicken" or Kosher. But what's really in a hot dog? Do we really want to know? And just what has the composition of hot dogs got to do with an article that is ostensibly about leaking underground storage tanks, anyway? Well, it has to do with this propensity to not want to know about those ingredients...even the ingredients in our own drinking water.

■ *continued on page 2*

### Inside

- 7 NEIWPCC Survey on Oxygenates at LUST Sites: Part 1
- 10 An Overview of Treatment Technologies for MTBE
- 14 Part 2: Surface Flux-Chamber Method
- 19 Taking On Today's Challenges
- 20 DE's Systemwide Approach to Preventing Releases
- 25 Baffled by a Leak? Check the Inventory Records
- 29 Thoughts on the Tortoise and the Hare Revisited
- 30 ME's Dispenser and Submersible-Pump Sump Study
- 33 PEI's 2003 Edition of RP200
- 34 CA Water District Sues Oil Companies
- 34 CA Updates Guidance on ELD and SIR
- 36 EPA HQ Update

## ■ Hot Dogs from page 1

### Is Ignorance Bliss?

The drinking water supply systems in the United States are unquestionably the best in the world. Most people can simply turn on the faucet and draw a glass of fresh, clear water that they can put unflinchingly to their lips and drink. Yet, a growing segment of the population uses a filter of some sort, and increasing numbers of people buy bottled water. In fact, in the last 40 years, it is estimated that the U.S. drinking water industry has lost nearly 60 percent of its customers to competitors (currently unregulated) who are "bottled water and point-of-use/point-of-entry providers." (Means et al., 2002) Why?

The reasons are many—taste, odor, color, fad/style, fear (justified or imagined). For those of us on public water supplies, our water suppliers provide us with annual Consumer Confidence Reports (CCRs) that show us that our water has been tested for

a variety of contaminants and is safe to drink. But most water suppliers analyze for a couple dozen contaminants at most. The CCRs tell us whether or not these contaminants were detected and at what concentrations.

When these contaminants are detected, even when their concentration may from time to time exhibit a spike above a regulatory threshold, this water is still distributed to us. Generally an accounting gimmick, such as 30-day average concentration, is employed so that it can be claimed that although detected above the limit, the concentration did not exceed "permissible" levels and the water is safe to drink.

For example, if the analytical report for a sample indicates that each of the BTEX compounds is present but at concentrations below their MCLs (5 ppb, 1,000 ppb, 700 ppb, and 10,000 ppb, respectively), is water with up to 11,705 ppb of BTEX really safe to drink? Do we want to drink it knowing that although the levels are reportedly safe, these contaminants are present at all? Do we want our children drinking it? And, health concerns aside, how does it taste? What about other contaminants that are not on this list of only a couple dozen? Are some of them present and, if so, what do we know about them?

### Petroleum Cocktail Hour

Petroleum (and the various fuels distilled from petroleum) is composed of hundreds to thousands of individual organic compounds. (Although this article focuses on gasoline, much of the discussion is applicable to other fuels as well.) "Gasoline" is a complex blend of several hundred hydrocarbons (i.e., compounds that contain only hydrogen and carbon atoms) and other organic compounds that typically contain nitrogen, oxygen, or sulfur. The specific composition of any particular blend of gasoline is a function of the petroleum source, refining and blending processes, and additives (Kreamer and Stetzenbach, 1990). The composition also varies with geographic location and from season to season to maintain performance specifications and comply with regulatory requirements.

The primary groups of hydrocarbons in gasoline are the paraffins, olefins, naphthenes, and aromatics (Youngless et al., 1985). Table 1 lists some representative examples for each of the various classes of these organic compounds. Additive packages (which are generally proprietary) vary considerably and typically include compounds that function as antioxidants, antiicers, metal deactivators, detergents, and corrosion inhibitors, among others (Youngless et al., 1985). Some of these compounds are extremely large, complex molecules.

Some components of gasoline may also contain metal species. The most familiar of these, but not the only ones, are the organic lead compounds, which are no longer used in modern unleaded gasolines. In the past, especially with leaded fuels, a wide variety of dyes were incorporated into gasoline blends as well. Table 2 lists a few of the many gasoline additives.

In addition, a significant number of the compounds in gasoline are *unknown* (or unidentified), except for the number of carbon atoms they contain (Kreamer and Stetzenbach, 1990). What do we know about the toxicity of each of the compounds in gasoline? How do they behave in the environment? Which ones are in our drinking water and at what levels?

For an organic contaminant to show up in a water sample, it must be water soluble. It is well known that aromatic hydrocarbons (of which BTEX is probably the best recognized) are the most soluble constituents of gasoline. Table 3 lists 43 common gasoline constituents with solubility greater than 1 mg/L. Two of the nonaromatic compounds in this table have a higher solubility than ethylbenzene (the "E" in BTEX). This list isn't comprehensive, and there are undoubtedly other compounds with similar properties and, hence, significant water solubility.

While these constituents represent pure compound solubility, and individual solubilities from a mixture would be somewhat lower, the point is that there are lots of soluble constituents in gasoline that can appear in groundwater. If a sample is only analyzed for the aromatic fraction, how do we know that some of these other constituents are not also present?



## LUSTLine

Ellen Frye, *Editor*  
Ricki Pappo, *Layout*

Marcel Moreau, *Technical Advisor*  
Patricia Ellis, Ph.D., *Technical Advisor*  
Ronald Poltak, *NEIWPCC Executive Director*  
Lynn DePont, *EPA Project Officer*

LUSTLine is a product of the New England Interstate Water Pollution Control Commission (NEIWPCC). It is produced through a cooperative agreement (#CT825782-01-0) between NEIWPCC and the U.S. Environmental Protection Agency.

LUSTLine is issued as a communication service for the Subtitle I RCRA Hazardous & Solid Waste Amendments rule promulgation process.

LUSTLine is produced to promote information exchange on UST/LUST issues. The opinions and information stated herein are those of the authors and do not necessarily reflect the opinions of NEIWPCC.

This publication may be copied.  
Please give credit to NEIWPCC.

NEIWPCC was established by an Act of Congress in 1947 and remains the oldest agency in the Northeast United States concerned with coordination of the multimedia environmental activities of the states of Connecticut, Maine, Massachusetts, New Hampshire, New York, Rhode Island, and Vermont.

### NEIWPCC

Boott Mills South, 100 Foot of John Street  
Lowell, MA 01852-1124  
Telephone: (978) 323-7929  
Fax: (978) 323-7919  
lustline@neiwpcc.org

LUSTLine is printed on Recycled Paper

## Toxicity of Petroleum Constituents

It should come as no surprise to anyone that exposure (e.g., through inhalation, ingestion, or dermal contact) to any of the constituents of gasoline (or any other fuel) at any concentration should be avoided. Exposure to the vapors from most gasoline constituents can cause dizziness, drowsiness, unconsciousness, and other adverse effects on the central nervous system. Prolonged exposure to low concentrations, or brief exposure to higher concentrations, may damage internal organs, cause cancer or birth defects, or may even be fatal. Ingestion of the liquid phase of neat gasoline (and most, if not all, of its individual constituents) is acutely toxic.

So where do we find information on the toxicity of specific constituents? We would expect that one of the best sources is a material safety data sheet (MSDS), and there are many places to find them on the Internet. But they are readily available only for a small percentage of the constituents of gasoline, and, as they only pertain to exposure to a single compound, the effects of exposure to dilute aqueous mixtures are entirely unknown. (This issue is likely to be one of the important public health challenges of this century, and further discussion is way beyond the scope of this article.)

One of the current ways to deal with a large number of organic compounds is to distribute them into smaller groups, each of which has a designated "surrogate." This is the approach adopted by the Total Petroleum Hydrocarbon Criteria Working Group (TPHCWG). In this method, it is presumed that all members of the group have properties that are similar to the surrogate.

But the approach has several drawbacks. First, compound toxicity isn't necessarily the same for each of the group members, and often the toxic characteristics of a significant proportion of the group are unknown. Second, the presence of the surrogate in a sample may not necessarily mean that there are any other compounds in the sample; if they are, they are probably not at the same concentration. Third, the absence of the surrogate in a sample may not

necessarily mean that all of the other compounds in the class are also absent from the sample. Fourth, many states are statutorily authorized to regulate only those contaminants that appear on EPA's list (i.e., 40 CFR 302.4, discussed in the "Regulation..." section below).

Sadly, the focus on compound toxicity has been so narrowly concentrated on human carcinogenicity that adverse effects other than cancer are usually conveniently ignored. In almost any discussion of risk management, there is no consideration of the teratogenic (birth defect) or mutagenic (mutation) effects of these toxic compounds—not to mention taste or odor!

***We have no idea what contaminants are really in the water we drink (or the hot dogs we eat). Simply because a contaminant isn't listed on an analytical report does not mean that the contaminant is not present in the sample. The truth is that we just don't know, but what we don't know can potentially hurt us.***

The issue of exposure to multiple toxicants is likewise given short shrift—exposure to multiple toxic compounds is limited to presumed simple additive effects, if it's considered at all. Yet, it is well recognized that the toxicity of a chemical may be increased (or in some cases even decreased) by simultaneous or consecutive exposure to another chemical (Lu, 1991). There is no consideration of synergistic (multiplicative) effects, or whether mixtures may contain procarcinogens, cocarcinogens, or cancer promoters.

And then there's the issue of whether or not a specific compound is a human carcinogen or just an animal carcinogen. Too often an animal carcinogen is touted as being a human noncarcinogen simply because there isn't any confirmation that the compound causes cancer in humans. However, saying that a compound is a noncarcinogen, when the truth is that there isn't enough

information about it to determine whether or not it is a human carcinogen (although the compound is a known animal carcinogen), is being less than honest.

Admittedly, it is difficult (maybe even impossible) to demonstrate with 100 percent certainty that any chemical is a noncarcinogen. But for compounds that are known animal (especially mammalian) carcinogens, ordinary common sense would tell a reasonable person that these are substances with which unnecessary contact should be avoided, even at low concentrations and especially in mixtures that contain substances that may promote cancer.

In theory, a single molecule of a carcinogen can induce cancer. This means that there is no threshold dose and therefore no safe level of exposure to carcinogens. While not all cancer researchers hold this view, the opposing view (i.e., that threshold doses for carcinogens do exist) has yet to be demonstrated, even though large-scale experiments have been conducted for this purpose (Lu, 1991). Further complicating the issue is that unless a fatal quantity of pure product is ingested, most of the toxic effects are slow to develop (10 to 20 years or more in humans) and may be masked by other ailments as we age.

## Regulation of Hazardous Substances

Underground storage tanks containing hazardous substances are regulated by the UST program under 40 CFR 280. Additional regulations regarding hazardous substances are found in 40 CFR 302.4 and 40 CFR 261.24. The first of these, CFR 302.4 (U.S. EPA, 2001a), is U.S. EPA's list of approximately 800 Hazardous Substances. Of these substances, only a handful are petroleum hydrocarbons found in fuels, and even fewer are fuel additives. (See Table 4.)

The second regulation, 40 CFR 261.24, is the Toxicity Characteristics (TC) rule for identifying RCRA hazardous wastes. The TC rule specifically exempts "petroleum contaminated" media and debris that fail the test for the toxicity characteristic of 40 CFR 261.24 (U.S. EPA, 2001b). Section 261.24(b) refers to 25 contami-

■ continued on page 4

## ■ Hot Dogs from page 3

nants (but actually lists 26) that are specifically exempt from consideration as “hazardous wastes,” provided they are subject to the corrective action regulations under 40 CFR 280 (the UST regulations). This list of 26 contaminants includes benzene and only two additional chemicals (cresol and pyridine) that *may* be present in gasoline or other petroleum fuels.

We all know that none of the components of gasoline (or other petroleum fuels) are healthy for us, so why is it that so few fuel constituents are officially designated as “toxic” or “hazardous”? Part of the answer is that there are simply too many potentially toxic substances to list; some are unidentified, and adequate toxicity testing hasn’t been conducted on others. Although not limited to organic compounds, the Chemical Abstract Service (CAS) assigns unique registration numbers (known as CAS or CASRN) to new chemicals at a rate of about 4,000 per day!!! (See <http://www.cas.org/EO/regsys.html>.)

Another part of the answer is that petroleum fuels as a whole are a critical part of the world economy. They’ve been used for close to 100 years, so we’re familiar with them, we need them, and we consider them to be relatively “safe.” Perhaps the primary reason why gasoline is considered “safe” is because UST regulations are relatively effective—at least to the extent that there aren’t daily media reports of explosions, fires, and underground rivers of gasoline flowing beneath our feet.

However, as we all know, releases from UST systems do happen, sometimes with immediate and catastrophic effect. Every day there are releases of gasoline (and other fuels) into the environment, and a significant amount of the released fuel eventually winds up in groundwater or surface water or both, some of which is used for drinking water. So how do we know what toxic compounds (if any) are actually in our drinking water?

### Identification of Toxic Compounds

Let’s assume that we have a water sample that may or may not be conta-

minated with one or more of the hundreds of petroleum constituents in gasoline. What tests can we conduct to determine what contaminants are in the sample? Several analytical methods are potentially available to us to determine if any contaminants are present in the sample and at what concentrations. Though not the sole source for analytical methods, EPA’s compendium of analytical methods, SW-846, (U.S. EPA, 1997) offers us several choices of determinative analytical methods for organic compounds, including: Methods 8015, 8021, 8260, and 8270. Let’s look into each of these in ascending numerical order. (See Table 5.)

■ **Method 8015** (Nonhalogenated Organics Using GC/FID) explicitly lists 30 compounds, of which only four may be present in gasoline. Only one—methanol—is on the list of hazardous substances. This method may also be used for Gasoline Range Organics (GRO) and Diesel Range Organics (DRO), but other methods (which aren’t specified in the scope) may be more applicable. No additional guidance is provided regarding GRO or DRO.

■ **Method 8021** (Aromatic and Halogenated Volatiles by Gas Chromatography Using Photoionization and/or Electrolytic Conductivity Detectors) explicitly lists 57 compounds, of which 10 may be present in gasoline and are also on the list of hazardous substances.

■ **Method 8260** (Volatile Organic Compounds by Gas Chromatography/Mass Spectrometry) explicitly lists 107 compounds, of which about a dozen may be found in gasoline and are also on the list of hazardous substances.

■ **Method 8270** (Semivolatile Organic Compounds by Gas Chromatography/Mass Spectrometry) explicitly lists about 250 compounds, of which only a couple are likely to be found in gasoline (although many more could be present in diesel fuel and heavier fuel oils) and are on the list of hazardous substances.

U.S. EPA drinking water methods 502 and 524.2 contain a slightly different list of chemicals.

Of the more than 400 target compounds identified by the four 8000-series methods, approximately 5 percent may be present at any given petroleum release site. “Well and good,” you’re thinking, “but what’s the point of this?”

### Absence of Proof Is Not Proof of Absence

Well, the first point of this is that we have no idea what contaminants are really in the water we drink (or the hot dogs we eat). Simply because a contaminant isn’t listed on an analytical report does not mean that the contaminant is not present in the sample. (Note that the converse is also true—that is, there is no proof that the contaminant is present.) The truth is that we just don’t know, but what we don’t know *can* potentially hurt us.

There are a lot of reasons why the presence of a contaminant in a sample might go unrecognized:

- There was no analysis for the contaminant.
- There was an analysis for the contaminant, but an inappropriate method was used.
- The analytical method was applied incorrectly.
- The detection limit is very high.
- Matrix interferences.

In each of these cases, a contaminant could be in a sample, but its presence (and concentration) is undetected (and undetermined). We have to do a better job than we currently do to both anticipate which potential contaminants may be present at a given site and analyze for all of them to determine whether they are in fact present or absent.

In addition to the desirability of knowing all chemicals present for the purpose of conducting a risk assessment, it is important to know all the contaminants present when developing a remediation plan.

In one of my recent projects, carbon filters used as point-of-entry treatment for domestic wells were breaking through in far shorter times than what was expected. After run-



ning Method 8260 plus requesting that all "tics" be identified by a library search, we identified a total of 45 additional chemicals, all potentially having a gasoline source, as being present in the water samples. These additional chemicals all contributed to the loading on the carbon filters and contributed to the early breakthrough. The library search gave estimated concentrations, but none of these compounds had been calibrated against a standard.

I might also have been happier if I hadn't added dissolved lead to the list of analytes because of earlier detections of EDC. Dissolved lead exceeded recommended levels in every sample (pre- and post-carbon filters), and in every well, even where no gasoline components were detected. Further analysis, this time for tetraethyl and tetramethyl lead, the organic lead that would come from leaded gasoline, was negative. Elevated lead levels appeared to be present throughout the aquifer, which would also have to be factored into a risk assessment. While the carbon filters were dealing with the gasoline contamination in the wells, albeit in an expensive manner, the filters had no effect on the dissolved lead.

Further, it isn't enough to have samples analyzed even for all potential contaminants if the samples aren't representative. Samples must be collected from locations where contaminants are most likely to be present, and they must be correctly handled during collection, transport, preparation, and analysis.

### Fuel-Specific Analytical Methods

My second point is that the current analytical practices we rely on to determine whether gasoline compounds are present or absent in water (and soil) samples are incomplete and therefore inadequate. Standard operating procedures for Methods 8015, 8021, 8260, and 8270 require calibration for only a few of the many compounds that are present in gasoline, but many compounds are either not present or are unknown.

Target analyte lists must be refined so that they are more representative of the contaminants that are

**Table 1 Representative Organic Compounds Found in "Gasoline"**

<p><b>Straight Chain Alkanes</b> propane n-hexane n-dodecane</p> <p><b>Branched Alkanes</b> isobutane 2,2-dimethylbutane neopentane 3-ethylhexane</p> <p><b>Cycloalkanes</b> cyclohexane n-propylcyclopentane ethylcyclohexane</p> <p><b>Straight Chain Alkenes</b> cis-2-butene 1-pentene trans-2-heptane</p> <p><b>Branched Alkenes</b> 2-methyl-1-butene 4,4-dimethyl-cis-2-pentene</p>	<p><b>Cycloalkenes</b> cyclopentene 3-methylcyclopentene</p> <p><b>Alkyl Benzenes</b> benzene toluene ethylbenzene o-xylene m-xylene p-xylene 1,2-dimethyl-3-ethylbenzene 1,2,3-trimethylbenzene 1,2,4,5-tetramethylbenzene n-propylbenzene</p> <p><b>Other Aromatics</b> indan 1-methylindan phenol</p> <p><b>Polycyclic Aromatic Hydrocarbons (PAHs)</b> naphthalene</p> <p><i>Source: Adapted from Cole (1994).</i></p>
--	--

**Table 2 Representative Organic Compounds Used as Additives in "Gasoline"**

<p><b>Oxygenates</b> methyl <i>tertiary</i>-butyl ether (MTBE) ethanol ethyl <i>tertiary</i>-butyl ether (ETBE) <i>tertiary</i>-butyl alcohol (TBA) <i>tertiary</i>-amyl ethyl ether (TAEE) diisopropyl ether (DIPE) <i>tertiary</i>-amyl methyl ether (TAME) <i>tertiary</i>-amyl alcohol (TAA) methanol</p> <p><b>Anti-knock compounds</b> tetra-ethyl lead (TEL) tetra-methyl lead (TML) methylcyclopentadienyl manganese tricarbonyl (MMT)</p> <p><b>Anti-oxidant compounds</b> hindered phenols phenylene diamines aminophenols</p> <p><b>Anti-icing compounds</b> isopropyl alcohol amides/amines glycols organophosphate ammonium salts</p>	<p><b>Corrosion inhibitors</b> carboxylic acids sulfonates amine/alkyl phosphates</p> <p><b>Metal deactivators</b> disalicylidene amines phenolic amines thiourea</p> <p><b>Ignition controller additives</b> tri-<i>o</i>-cresol phosphates</p> <p><b>Detergents</b> aminohydroxyamide alkylphenols imidazolines</p> <p><b>Lead scavengers</b> 1,2-dichloroethane (EDC) 1,2-dibromoethane (EDB)</p> <p><b>Dyes</b> azobenzene-4-azo-2-naphthol benzene-azo-2-naphthol para-diethyl aminoazobenzene 1,4-diisopropylaminoanthraquinone</p> <p><i>Source: Adapted from Cummings (1977) and Irwin, et. al. (1997).</i></p>
--	---

likely to be encountered at fuel-release sites. For example, nearly 90 percent of the analytes listed for Method 8021 are halogenated compounds that would *not* be present at fuel-release sites—why should a sample be analyzed for them and *not* for some of the few hundred other

contaminants that may actually be present? If we're going to pay for an analysis for, say, 100 compounds, wouldn't it be more cost-effective if those 100 could be reasonably anticipated to be in the sample?

■ *continued on page 6*

## ■ Hot Dogs from page 5

And, in order to credibly evaluate the actual risk posed by contaminants in our water, we absolutely *must* know which contaminants are in the water. In a recent series of articles by Uhler and others (2002, 2003), similar suggestions were made. They suggest a suite of 109 target analytes for the analysis of automotive gasoline using a Modified 8260 method. The list contains the PIANO compounds (Paraffins, Isoparaffins, Aromatics, Naphthenes, and Olefins), useful for recognizing peculiarities that might be inherited from refinery processes (including

various major and minor iso-alkanes), and gasoline additives, including the oxygenate additives (alcohols and ethers), lead scavengers (EDC and EDB), and methylcyclopentadienyl manganese tricarbonyl (MMT). Some of this list of compounds can be useful in fingerprinting gasoline for environmental forensic investigations, as well as a basis for conducting a risk assessment.

Just how credible, how “scientifically defensible” is a risk assessment based on omission, neglect, or wishful thinking? To only evaluate the risk posed by some, but not all, contaminants present at a site is like crossing a busy highway but only looking

in one direction as you make the attempt. Sure, you may not get hit by a car coming from the direction in which you’re looking, but one from the blind side is likely to spoil your day.

Appropriate analytical method(s) already exist in today’s marketplace. All that is lacking are appropriate calibration standards and standard operating procedures that have been optimized for analysis of these target analytes. Once it becomes routine to use these standards, risk assessments could be conducted for the contaminants to which receptors are actually exposed, rather than presumed surrogates. This will go a long way toward bolstering the credibility of risk assessment and restoring confidence in the safety of our drinking water.

### Take Me Out to the Ballgame

Alternatively, we could opt to accept the status quo...we can slump down in our bleachers, hot dog in one hand, and glass of water (OK, beer) in the other, and blissfully pass away the time. ■

*Pat Ellis is a hydrologist with the Delaware Department of Natural Resources and Environmental Control, Tank Management Branch and served as a member of EPA’s Blue Ribbon Panel on MTBE. She is a technical advisor and regular contributor to LUSTLine and can be reached at Patricia.Ellis@state.de.us.*

**Table 3**  
Common Gasoline Constituents  
Ranked by Solubility (mg/L)

Benzene	1,780
Toluene	515
o-Xylene	220
cis-2-Pentene	203
Cyclopentane	156
Ethylbenzene	152
1-Pentene	148
3-Methyl-1-butene	130
Indan	100
1-Methyl-4-ethylbenzene	95
1,2,3-Trimethylbenzene	77
1-Methyl-2-ethylbenzene	75
Propane	62
1,2,4-Trimethylbenzene	57
Cyclohexane	55
n-Propylbenzene	52
Isopropylbenzene	50
1,3,5-Trimethylbenzene	50
Isobutane	48.9
Methylcyclopentane	42
Pentane	38.5
Naphthalene	31
1-Methyl-naphthalene	28
2-Methyl-naphthalene	25
2,2-Dimethylbutane	18.4
sec-Butylbenzene	17
Methylcyclohexane	14
Isopentane	13.8
2-Methylpentane	13.8
n-Butylbenzene	13.8
3-Methylpentane	12.8
Isobutylbenzene	10.1
Hexane	9.5
2,3-Dimethylpentane	5.25
1,2,4,5-Tetramethylbenzene	3.48
3-Methylhexane	3.3
n-Heptane	2.93
2-Methylhexane	2.54
2,2,4-Trimethylpentane	2.44
2,3,4-Trimethylpentane	2
1-Nonene	1.12

Source: Adapted from Gustafson et al. (1997).

**Table 4**  
Hazardous Substances Listed in 40 CFR  
302.4 That May be Present in “Gasoline”

SUBSTANCE	CASRN
1,2-dibromoethane	106934
1,2-dichloroethane	107062
1,3-pentadiene	504609
benzene	71432
cresols	1319773
<i>ortho</i> -cresol	95487
<i>meta</i> -cresol	108394
<i>para</i> -cresol	106445
cyclohexane	110827
ethylbenzene	100414
methanol	67561
naphthalene	91203
phenol	108952
toluene	108883
xylene	1330207
<i>ortho</i> -xylene	95476
<i>meta</i> -xylene	108383
<i>para</i> -xylene	106423

Source: Adapted from Gustafson et al. (1997).

**Table 5** Compounds Present in “Gasoline” That Appear on Target Analyte  
Lists for Methods in SW-846

COMPOUND	8015*	8021	8260	8270
diethyl ether	x		x	
ethanol	x		x	
methanol	x		x	
pyridine	x		x	
benzene		x	x	
ethylbenzene		x	x	
naphthalene		x	x	x
toluene		x	x	
xylene		x		
o-xylene		x	x	
m-xylene		x	x	
p-xylene		x	x	
1,2-dibromoethane		x	x	
1,2-dichloroethane		x	x	
tertiary-butyl alcohol			x	
phenol				x

\*Method 8015 is also indicated to be applicable for GRO and DRO.

## EPA HQ UPDATE

### Analytical Methods Fact Sheet Available

Analytical methods for petroleum hydrocarbons are well established; however, methods that were developed for analysis of petroleum hydrocarbons in water samples may or may not be appropriate for fuel oxygenates. A fact sheet, titled *Analytical Methodologies for Fuel Oxygenates* (EPA 510-F-03-001), outlines the potential problems of analytical methods for common fuel oxygenates and ways to address these problems. It has been distributed to states and regions and is available on the OUST Web site at [www.epa.gov/oust/mtbe/omethods.pdf](http://www.epa.gov/oust/mtbe/omethods.pdf).

For more information, contact Hal White at (703) 603-7177.

### Senate Passes UST Legislation

On Thursday, May 1, the U.S. Senate passed the Underground Storage Tank Compliance Act (S. 195) by unanimous vote. The legislation provides additional flexibility and authorization of appropriations for preventing and cleaning up releases from USTs. It also includes a dedicated authorization of appropriation for the cleanup of MTBE, mandatory inspection frequencies, additional enforcement tools, and operator training guidelines. Although the House has been working on its version of UST legislation, companion legislation has not been introduced. EPA OUST has been providing technical comments on the proposed legislation.

*Have you checked your tank today?*

### LUSTLine T-Shirts

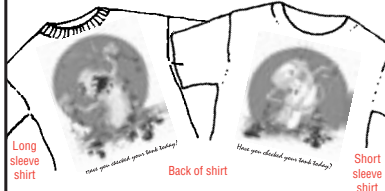

Long sleeve shirt      Back of shirt      Short sleeve shirt

**TWO new WACKY designs**  
created by LUSTLine cartoonist, Hank Aho

**TWO colors... red and black**

**TWO versions... long and short sleeve**

Long sleeve \$17.00  
Short sleeve \$13.00  
Sizes: M, L, X, XXL

**TO ORDER:** Send check or money order (*drawn on U.S. banks only*) to:

NEIWPCC  
Boott Mills South, 100 Foot of John Street,  
Lowell, MA 01852-1124  
Tel: (978) 323-7929 • Fax: (978) 323-7919

Front of shirt

### API to Present Two Free-Product Cleanup Workshops at 20th Annual API/ NGWA Groundwater Conference

For more information, go to  
API Conferences and  
Workshops link at  
[www.api.org/groundwater](http://www.api.org/groundwater)

## L.U.S.T.LINE

New England Interstate Water  
Pollution Control Commission  
Boott Mills South  
100 Foot of John Street  
Lowell, MA 01852-1124

Non-Profit Org.  
U.S. Postage  
**PAID**  
Wilmington, MA  
Permit No.  
200

## **Use of TPH Action Levels (HDOH 2024)**

JOSH GREEN, M.D.  
GOVERNOR OF HAWAII  
KE KIA'ĀINA O KA MOKU'ĀINA 'O HAWAII



KENNETH S. FINK, MD, MGA, MPH  
DIRECTOR OF HEALTH  
KA LUNA HO'ŌKELE

STATE OF HAWAII  
DEPARTMENT OF HEALTH  
KA 'OIHANA OLAKINO  
P. O. BOX 3378  
HONOLULU, HI 96801-3378

In reply, please refer to:  
File: RB-21-24

Date: March 25, 2024 (DRAFT)

To: Interested Parties

Through: Grace Simmons, Program Manager *GraceLda Simmons*  
Hazard Evaluation and Emergency Response Office

From: Roger Brewer, PhD *Roger Brewer*  
Hazard Evaluation and Emergency Response Office

Subject: *Comparison of HIDOH Total Petroleum Hydrocarbon (TPH) Action Levels to Data for Water Samples*

This memorandum provides additional information regarding use of Hawai'i Department of Health (HIDOH) Environmental Action Levels (EALs) for Total Petroleum Hydrocarbon (TPH) for screening of water data, including groundwater, tapwater and surface water. The basis for this described approach is provided in the attachment to the memorandum.

Three categories of petroleum fuel and associated TPH EALs are presented in the EAL lookup tables: 1) Gasolines (TPH<sub>gasolines</sub>), 2) Middle Distillates (TPH<sub>middle distillates</sub>) and 3) Residual Fuels (TPH<sub>residual fuels</sub>). "Middle Distillate" fuels include diesel, kerosene and jet fuel. "Residual Fuels" include motor oil and other heavy fuels and petroleum products. The action levels apply to the single, total concentration of non-specific (e.g., non BTEXMN) hydrocarbon and hydrocarbon-related degradation compounds (aka "Hydrocarbon Oxidation Products" or "HOPs") present in a water sample and known or assumed to be associated with one of the three-noted categories of fuel. The most conservative action levels should be used for comparison to sample data if the specific type of fuel released cannot be determined or contamination is associated with a mixture of fuel two or more of the noted fuel categories.

Scrutiny of groundwater sample data following the 2021 jet fuel release at the Navy's Red Hill facility in Honolulu identified concerns that the total concentration of TPH-related compounds in a sample was not being adequately quantified. This led to confusion regarding comparison of fuel-specific, TPH EALs to sample data for individual ranges of organic compounds in a sample often reported separately by laboratories.

In short, there is only one concentration of TPH-related contaminants in a sample. The concentration of "TPH" in a water sample derived for comparison to a corresponding TPH action level should be calculated as the sum of the concentration of Total Purgeable Organics for

volatile compounds plus the concentration of Total Extractable Organics for semi-volatile and non-volatile compounds. Volatile compounds are commonly reported as “Gasoline Range Organics (GRO)”, for example using a combined gas chromatography and mass spectrometry (GC-MS) analysis such as Method 8260. Semi-volatile and non-volatile compounds are commonly and reported as “Diesel Range Organics (DRO)” and “Residual Range Organics (RRO)”, for example using gas chromatography Method 8015. The concentration of TPH in a sample is therefore calculated as:

$$\text{TPH} = \text{Total Purgeable Organics} + \text{Total Extractable Organics};$$

or in terms of individual fuel ranges:

$$\text{TPH} = \text{GRO} + \text{DRO} + \text{RRO}.$$

Test methods for Purgeable Organic Compounds and Extractable Organic Compounds can overlap the same carbon range. Volatile compounds reported under purgeable test methods are largely lost in processing of samples to be tested using extraction methods, however. Potential double counting is therefore minimal and does not need to be considered.

The identification of middle distillate-related, organic compounds in a water sample based only on gas chromatography becomes unreliable below a laboratory Method Reporting Limit (“MRL”, aka “Laboratory Quantification Limit”) of approximately 200 µg/L. Samples of drinking water and groundwater that are a current or potential source of drinking water with reported concentrations of Total Extractable Organics (e.g., “DRO” or “RRO”) below this concentration should be retested for individual compounds using a combined GC-MS method such as Method 8270. The resulting data should be reviewed by a chemist experienced in petroleum forensics to determine if the compounds are associated with petroleum-related contamination or other, nonpetroleum-related organic matter in the water. Concentrations of organic matter below the MRL should not be reported as “TPH” until such verification has been made.

Questions and comments should be directed to Roger Brewer with HIDOH (roger.brewer@doh.hawaii.gov).

### References

HIDOH, 2024, *Evaluation of Environmental Hazards at Sites with Contaminated Soil and Groundwater – Hawaii Edition (Draft Spring 2024)*: Hawai’i Department of Health, Office of Hazard Evaluation and Emergency Response.

HIDOH, 2023, *Technical Guidance Manual* (and updates): Hawai’i Department of Health, Office of Hazard Evaluation and Emergency Response, <https://health.hawaii.gov/heer/tgm/>

### Laboratory Analysis of Petroleum-Related Compounds

Petroleum fuels are made of hundreds of individual compounds of differing volatility and sorptive capacity (Figure 1). The lowest boiling point compounds are typically referred to by the laboratory as “Gasoline Range Organics (GRO), due to the predominance of such compounds in gasolines. Mid-range boiling point compounds are commonly referred to as “Diesel Range Organics (DRO)” for the same reason with respect to diesel-based fuels. High boiling point and low-volatility compounds are referred to as “Residual Range Organics (RRO).” Volatile, GRO-range compounds (e.g., C5-C12) are identified and quantified using “purge-and-trap” analytical methods. Less volatile DRO-range compounds (e.g., C8-C24 or C10-C24) and RRO-range compounds (e.g., >C24) are identified and quantified using extraction methods.

The area under the resulting “hump” generated on a gas chromatograph (GC) is compared to laboratory standards for the known or assumed fuel type and used to identify the primary type of fuel present. The presence of GRO range compounds in a sample does not necessarily mean that gasoline is present, only that some compounds within the fuel fell within this range. Jet fuels, for example, can consist of hydrocarbon compounds that span both GRO and DRO boiling point ranges (e.g., refer to HIDOH 2022).

Hydrocarbon-related degradation products are assumed to have a similar toxicity as the parent compounds (HIDOH 2024). Polar compounds should therefore not be removed from water samples using silica gel cleanup (SGC) or other methods prior to testing. Comparison of SGC to non-SGC data can, however, assist in determining the overall state of degradation of the petroleum.

### Laboratory Reporting Ranges vs TPH Action Levels

Confusion in the application of TPH action levels to water sample data is caused in part by use of the terms “Gasoline Range Organics,” “Diesel Range Organics” and “Residual Range Organics” by laboratories to report sample data. There is only one true concentration of “TPH” for a sample, which is the sum of concentrations of all hydrocarbon compounds detected across the three ranges that are not otherwise targeted for individual assessment (e.g., BTEX and PAHs). That concentration should be compared to the TPH action level applicable to the primary type of fuel released. For example, where there has been a gasoline release, the total concentration of gasoline-related contaminants in a water sample should be compared to action levels for  $TPH_{\text{gasolines}}$ . Where there has been a diesel release, the total concentration of diesel-related contaminants in a water sample should be compared to action levels for  $TPH_{\text{middle distillates}}$ . If the nature of the fuel release is uncertain or in cases of release of multiple fuel types, the calculated concentration of TPH should be compared to the fuel category with the most conservative action levels.

Refer again to Figure 1. Two separate types of laboratory methods are required for testing of petroleum-contaminated media, including water. Volatile compounds are reported in terms of Total Purgeable Organics (e.g., “GRO”), using purge-and-trap techniques such as Method 8260. Sem-volatile are reported in terms of Total Extractable Organics (e.g., “DRO” and “RRO”), using extraction methods. Test methods for Purgeable Organic Compounds and Extractable Organic Compounds can overlap the same carbon range. Volatile compounds reported under TPO tests method are largely lost in TEO test extraction methods, however, so double counting is minimal.

Refer next to Figure 2. The case for water samples is more complicated. Dissolution of hydrocarbons into water will be biased toward more soluble, aromatic compounds. The mix of dissolved-phase compounds in water will therefore be different from that of the fuel itself. In the case of water contaminated by gasolines, dissolved-phase compounds such as benzene, toluene, ethylbenzene and xylenes (BTEX) will be reported as part of the GRO range compounds, as expected. As the compounds begin to degrade and become less volatile, however, they will elute on the chromatogram at a higher boiling point, with some compounds potentially eluting within the “DRO” range. Heavier RRO-related compounds are not normally found associated with degraded gasolines but should be included in initial sample data for a site to document that such contamination is not present. The total concentration of dissolved “TPH” in the sample is therefore most appropriately calculated as the sum of the reported concentration for GRO range compounds plus the reported concentration of DRO range compounds ( $TPH = DRO + GRO + RRO$ ).

Dissolved-phase middle distillate fuel, such as JP-5 jet fuel, can include BTEX as well as a significant amount of additional, heavier and less volatile aromatics (e.g., >C8 aromatics). This can lead to compounds falling within both the GRO and DRO ranges even in the absence of degradation (see Figure 2). As the GRO-range compounds degrade, they will again begin to be reported as “DRO.” As the DRO-range parent compounds degrade, they will elute on the chromatogram at a higher boiling point and in some case could reported as “RRO.” The total concentration of dissolved “TPH” in the sample is the sum of the concentrations reported for all three ranges ( $TPH = DRO + GRO + RRO$ ).

### **Consideration of Individually Targeted Compounds**

The concentration of individually targeted compounds such as BTEX and PAHs should be subtracted from the TPH data to avoid double counting (refer to TGM Section 9.3.1.2). This can be done by the laboratory on request or by the project consultant. In practice, this will make minimal difference in the concentration of TPH used for comparison to EALs, since the proportion of BTEX, PAHs and other individually targeted compounds is normally minimal in comparison to non-specific compounds collectively assessed as “TPH.”

### **Case-Specific TPH Action Levels**

Toxicity, along with physiochemical and other factors considered in the development of TPH action levels for specific fuel types are discussed in Volume 2, Appendix 1, Section 6 of the HDOH Environmental Action Level guidance (HDOH 2024). The assumptions used are intended to address the majority of petroleum-impacted sites in Hawai‘i without the need for a site-specific risk assessment.

Development of “case-specific,” TPH action levels will, however, be required in a small number of cases when assumptions incorporated into the default TPH action levels do not apply to conditions in the field. For example, the TPH action level for middle distillate fuels are based on the assumed, combined toxicity of GRO and DRO components of typical middle distillate fuels. (RRO components are negligible). The action level for drinking water (“tapwater”) also assumes that the fuel is partially oxidized and no longer significantly volatile. This decreases the overall exposure risk and results in a slight increase in action levels over fresh fuel that is still volatile.

If these conditions are not met in the field for a specific case, then a case-specific TPH action level(s) must be generated. For example, if fresh fuel is released and threatens a drinking water



supply, then alternative action levels would need to be developed that take into consideration volatilization of compounds from water and exposure via inhalation (e.g., HIDOH 2022).

Preparation of case-specific TPH action levels will normally be undertaken by the responsible party but might need to be generated by HIDOH in some instances. In either situation, the case-specific EAL and the rationale for its calculation must be reviewed and approved by HIDOH. The responsible party will also have the option to prepare alternative action levels at a later time in the response action, based on changes in site conditions, and provide this to HIDOH for review and approval (e.g., degradation and reduced volatility and toxicity of fuel-contaminated groundwater over time). Supporting field data must be provided to support changes to the initial action level.

### **Data Below the Method Reporting Limit**

Sample data for Total Purgeable Organics (e.g., GRO) or Total Extractable Organics (e.g., DRO or RRO) below the laboratory Reporting Limit for the test method (“MRL”; aka “Limit of Quantification”) cannot directly be assumed to be associated with petroleum-related compounds. This is because the concentration of organic compounds in the sample is too low to generate a recognizable, fuel-related pattern.

An MRL of 50 µg/L is typical for reporting of GRO range compounds. An MRL of 200 µg/L or higher is common for reporting of DRO and RRO compounds. Sample data below the MRL are normally qualified with “J” flag in the laboratory report. This indicates that neither the specific nature of the organic compounds identified, nor the true concentration of the compounds is certain. “J-flagged” data should not be reported as “TPH” by the laboratory. The organic compounds identified might or might not be related to petroleum. Algae and other organic matter are also common in water at these concentrations.

This will primarily be an issue for DRO-range organic matter detected below the typical MRL of 200 µg/L. In cases where there is a concern that J-flagged data could reflect hydrocarbon-related contamination in a sample and cause the sum concentration of Total Purgeable Organics and Total Extractable Organics to exceed the TPH action level, the sample be immediately retested using Mass Spectrometry (MS) methods (e.g., Method 8270). This allows individual compounds to be identified. An experienced chemist can then determine if the compounds are more likely to be associated with dissolved hydrocarbons or hydrocarbon-related degradation products or more likely related to other organic material in the sample, such as algae. A Fact Sheet on the use of mass spectrometry methods as a forensics tool to determine the likely origin of J-flagged compounds is included as an attachment to the memorandum.

If a conclusion is made that the compounds are likely related to hydrocarbons, then the data should be considered for calculation of a final TPH concentration for the sample. If the review suggests that the compounds are unlikely related to hydrocarbons, then the data do not need to be incorporated into calculation of TPH. As a default, J-flagged data should be assumed to reflect hydrocarbon-related compounds in cases where petroleum contamination has otherwise been confirmed unless disproven by more MS or other detailed analysis.

Note that an elevated MRL for a range typically reflects a high concentration of contaminants in one of the other ranges or otherwise in the sample. Discussions regarding next steps can proceed if the sum TPH concentration exceeds the action level for the fuel-type involved. If not, discuss the reasons for the elevated MRL and need for retesting of the sample with the laboratory and the overseeing project manager at HIDOH.

“Non-detects” at the laboratory Method Detection Level (MDL) do not need to be considered in calculation of a final TPH concentration for a sample unless otherwise required by HDOH.

### **Quantification of TPH in Other Media**

Summing of Total Purgeable Organics (e.g., GRO) data and Total Extractable Organics data (e.g., DRO and RRO) for calculation of TPH is generally not necessary for soil samples. Environmental Action Levels for different categories of TPH in soil reflect concentrations that necessitate the presence of free product in the soil. The predominant makeup of “TPH” in the soil sample should more closely match the makeup of the original fuel, even if partially weathered, should in turn be captured by a single reporting range test (see Figure 1).

For example, the concentration of gasoline product in soil should be adequately captured by a purgeable organic compound test method and associated GRO data. The concentration of diesel and other middle distillate fuels in soil should be adequately captured by extractable organic compound test methods and associated DRO data, etc. Reported concentrations of GRO, DRO and RRO in soil can therefore be individually compared to soil action levels for TPH<sub>gasolines</sub>, TPH<sub>middle distillates</sub> and TPH<sub>residual fuels</sub>.

The concentration of TPH in air and soil vapor samples should be reported as the sum of C5 to C12 compounds and the data similarly compared to the indoor air and subslab soil vapor action level appropriate for the fuel in question (Section 7.13.1 of the HDOH *Technical Guidance Manual*, HDOH 2023). Summa canister methods are normally used for reporting of up to C12 hydrocarbons in air and vapor samples. The use of sorbent tube methods is necessary for reporting of >C12 hydrocarbons in air or soil vapor. The *Technical Guidance Manual* currently recommends the use of both Summa and sorbent sampling methods for air and vapor samples associated with middle distillate fuels. Testing of vapors from such fuels has consistently identified insignificant amounts of >C12 compounds, however. This negates the need for sorbent tube vapor sample data at petroleum release sites unless otherwise requested by HDOH or desired by the project consultant. Updates to the TGM to reflect this change are pending.

### **References**

HDOH, 2024, *Evaluation of Environmental Hazards at Sites with Contaminated Soil and Groundwater – Hawaii Edition (Draft Spring 2024)*: Hawai'i Department of Health, Office of Hazard Evaluation and Emergency Response.

HDOH, 2022, *Recommended Risk-Based Drinking Water Action Levels for Total Petroleum Hydrocarbons (TPH) Associated with Releases of JP-5 Jet Fuel*: Hawai'i Department of Health, Hazard Evaluation and Emergency Response, Technical Memorandum from Roger Brewer to Kathleen Ho, April 20, 2022.

ITRC, 2018, *TPH Risk Evaluation at Petroleum Contaminated Sites*: Interstate Technology & Regulatory Council. Washington D.C.

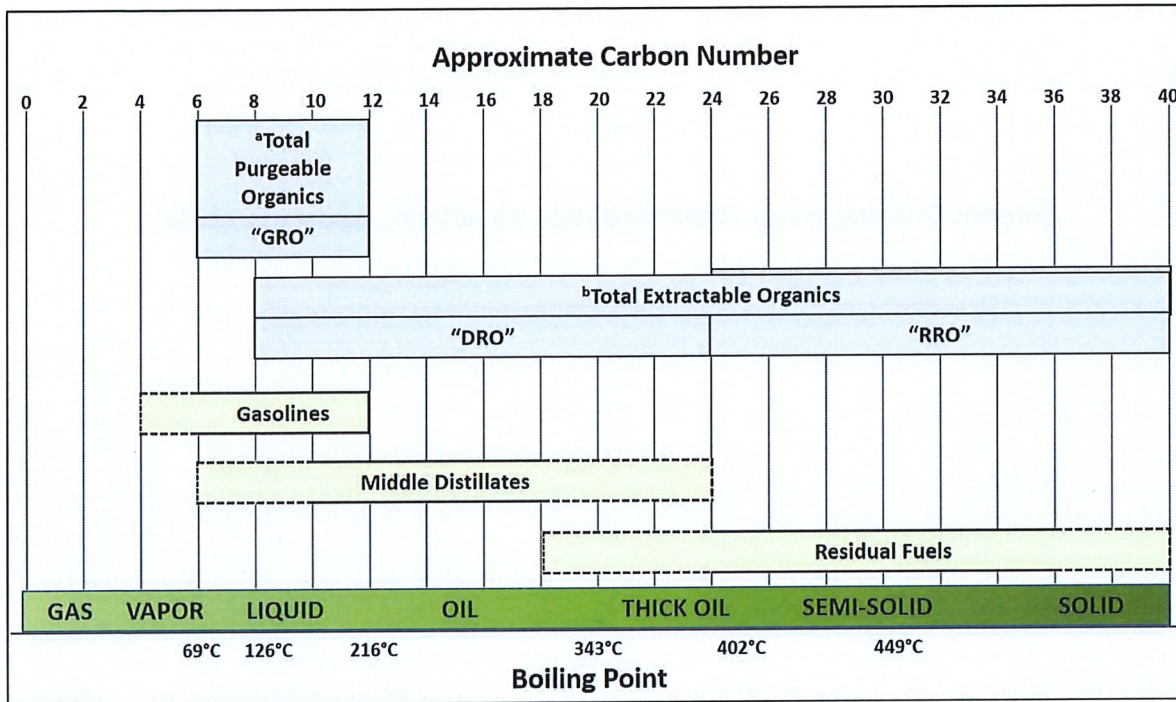

Figure 1. Comparison of fuel categories to laboratory analytical methods and reporting ranges; a) Total Purgeable Organics (TPO) methods are used to quantify volatile compounds (e.g., Method 8260 for "GRO"), b) Total Extractable Organics (TEO) methods are used to quantify semi-volatile compounds (e.g., Method 8015M for "DRO" and "RRO").

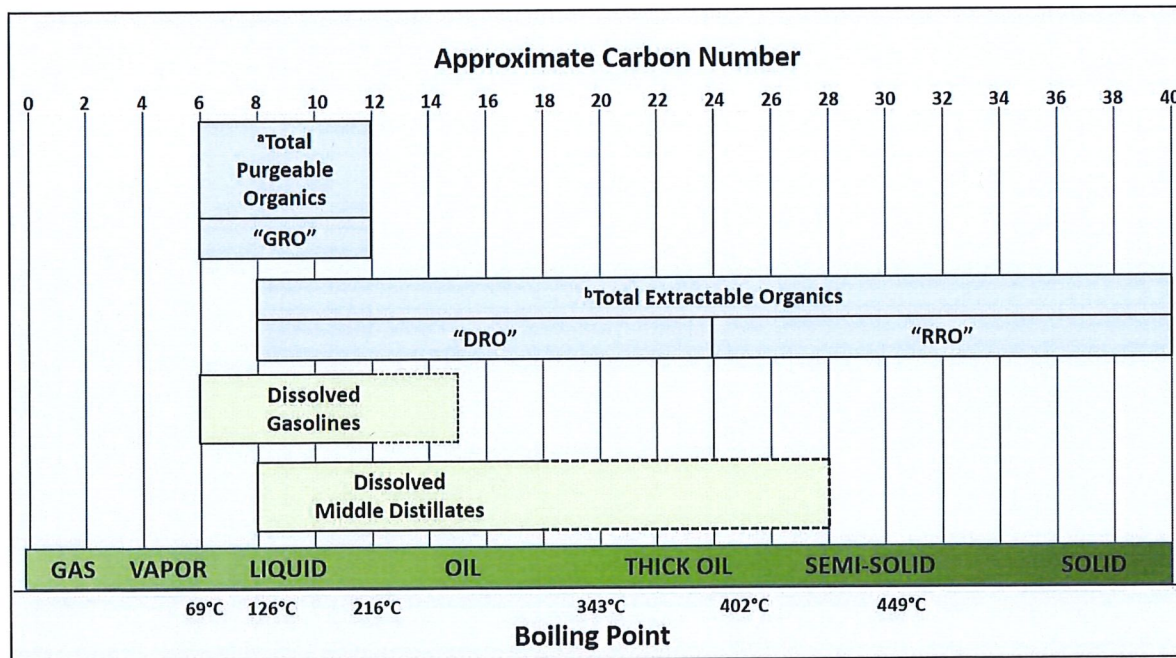

Figure 2. Comparison of dissolved fuels to laboratory analytical methods and reporting ranges. Note potential spread of lower volatility, fuel-related degradation compounds into higher boiling point reporting ranges. This requires addition of reported concentrations "GRO," "DRO" and "RRO" to estimate a total concentration of TPH-related compounds.

**Forensic Drinking Water Characterization (Newfields; January 30, 2024)**

---

---

# Forensic Drinking Water Characterization

Identifying Purgeable and Extractable Chemicals Included in Total Petroleum Hydrocarbon Measurements  
Prepared for the Hawaii Department of Health

## Introduction

Total Petroleum Hydrocarbon (TPH) analysis is a conventional laboratory technique used for monitoring drinking water samples for petroleum hydrocarbons. TPH analyses conducted using methods like USEPA Method 8015D by Gas Chromatography with a Flame Ionization Detector (GC/FID) provides a bulk measurement of extractable organics detected within a defined carbon range (e.g. gasoline range-GRO, diesel range-DRO, oil range-ORO; Figure 1).

However, GC/FID analysis cannot identify the specific chemicals reported within a bulk measurement. At higher relative concentrations it may be clear that a drinking water sample contains petroleum hydrocarbons, but at low levels confirmation analysis is needed to identify the chemical constituents. When analyzing samples with very low levels of organic matter, it is important to identify the specific chemicals present using a method like GC Mass Spectrometry (GC/MS). GC/MS analysis can be used to determine if low-level organic constituents in a sample are truly petroleum hydrocarbons or are actually related to other non-petroleum organic contaminants or naturally occurring biogenic materials like plant waxes or organic acids.

**Figure 1** provides an example of a drinking water sample with both petroleum hydrocarbons and naturally occurring plant waxes. In this example the DRO measurements include impacts from both petroleum and naturally occurring chemicals and contain a high bias due to non-petroleum constituents. Conventional TPH analysis cannot differentiate between these classes of chemicals.

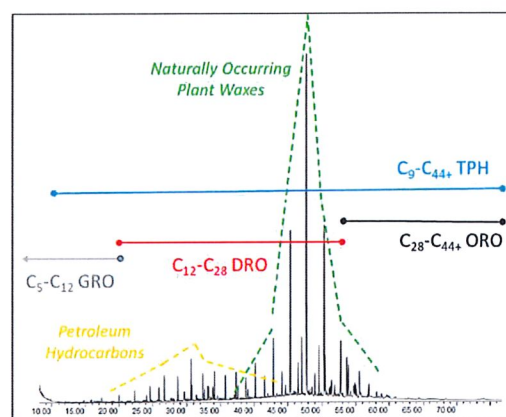

Figure 1. Example Drinking Water GC/FID Chromatogram

## Recommended Forensic Analysis for Low Level TPH Characterization

Forensic methods are designed to characterize source materials and are optimized for low level sample analysis. When characterizing low level TPH results it is recommended to follow a tiered analytical approach:

- ❖ Tier I: Modified EPA Method 8015D High Resolution GC/FID Fingerprint
  - High resolution GC/FID fingerprints provide greater separation between carbon ranges and allow for a more accurate assessment of potential source materials.
- ❖ Tier II: Confirmation Testing by GC/MS
  - Samples should then be analyzed by EPA Method 8260D for C<sub>5</sub>-C<sub>12</sub> purgeable organics and Method 8270E C<sub>8</sub>-C<sub>44+</sub> for extractable organics. This type of GC/MS data can be used to perform non-target analysis (NTA) and detect tentatively identified compounds (TICs) that can be used to identify the purgeable, and extractable chemical constituents present in low level TPH measurements. This analysis will help determine if TPH measurements are truly petroleum hydrocarbons or other non-petroleum constituents.
- ❖ Tier III: Petroleum Characterization
  - If petroleum hydrocarbons are present, samples can be analyzed by modified forensic Methods 8260D-PIANO volatile organic compounds and 8270E-Alkylated PAHs. These methods are designed to chemically characterize petroleum hydrocarbon residues, determine source type, and evaluate the degree of environmental weathering.