

TABLE OF CONTENTS

| | | |
|---------------|-------|-----------------------------------------------------------------------------------------------------------------------------------------------------------------------------------------------------------------------|
| Attachment 1 | _____ | Integrated Master Schedule Dated 15 December 2023 |
| Attachment 2 | _____ | Response to EPA 20 November 2023 Letter Enclosure Comments on the Work Plan, Environmental Protection Plan with Spill Response Plan, and Waste Management Plan Regarding Fuel Storage Tank Cleaning for Closure |
| Attachment 3 | _____ | PAK Meeting Agenda - Clean Red Hill Tanks - Redacted |
| Attachment 4B | _____ | Project Work Plan - Redacted |
| Attachment 5B | _____ | Environmental Protection Plan - Redacted |
| Attachment 6B | _____ | Waste Management Plan - Redacted |
| Attachment 7 | _____ | Tank 1 Hydrotest Water Lab Analysis |

ATTACHMENT 1: INTEGRATED MASTER SCHEDULE

[RETURN TO TABLE OF CONTENTS](#)

Navy Closure Task Force - Red Hill Integrated Master Schedule

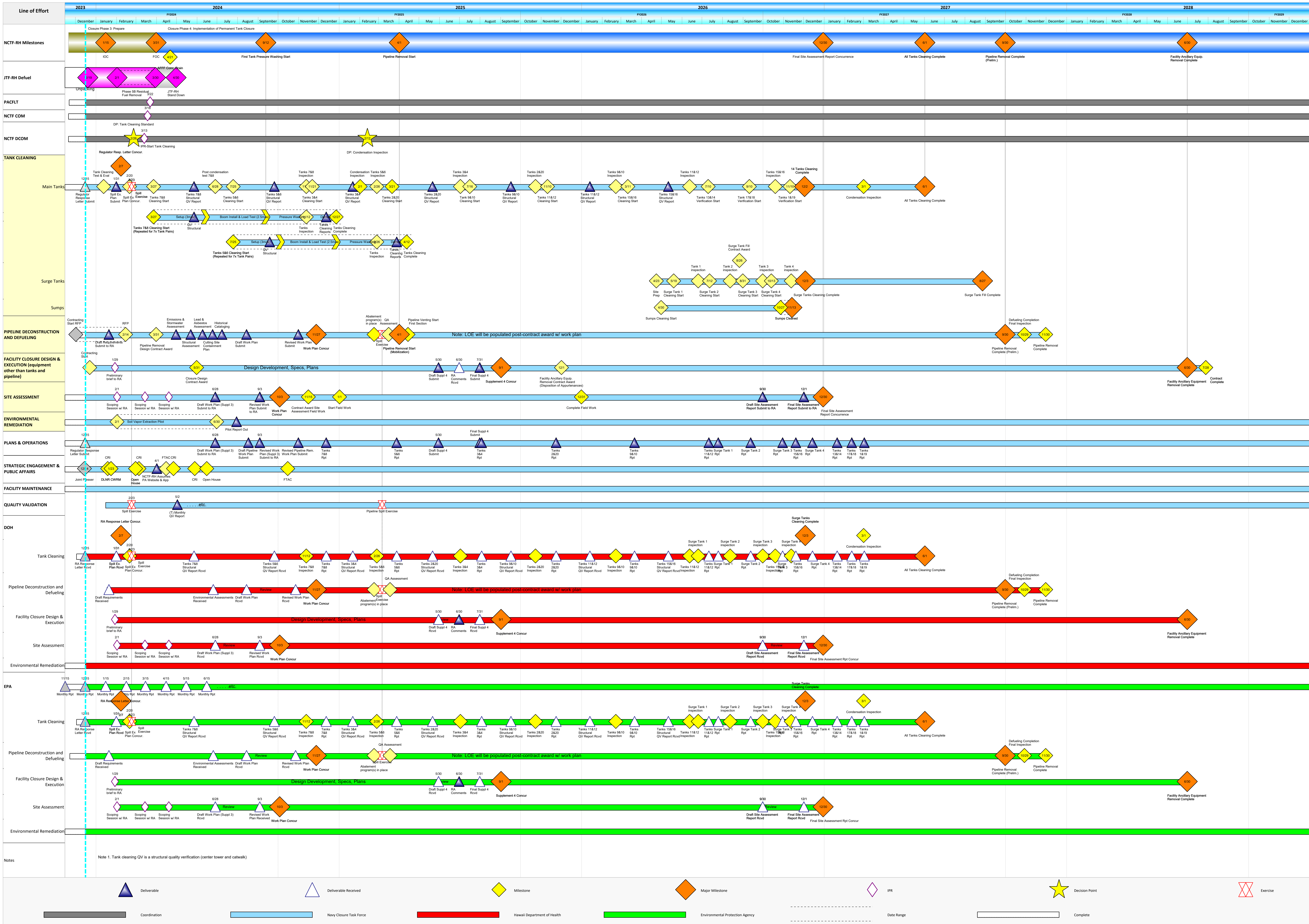

ATTACHMENT 2: NAVY RESPONSE TO EPA 20 NOVEMBER 2023 COMMENTS ON
THE WORK PLAN, ENVIRONMENTAL PROTECTION PLAN, AND WASTE
MANAGEMENT PLAN REGARDING FUEL STORAGE TANK CLEANING FOR CLOSURE

[RETURN TO TABLE OF CONTENTS](#)

Attachment 2
Response to EPA Comments on Clean Fuel Storage Tanks for Closure – Work Plan

1. ***Section 4,M “[S]afety will be maintained through compliance with the Accident Prevention Plan (APP) in addition to health and safety documents” - Please clarify which entity, contractor, or organization has line authority over the safety of the project.***

The contractor responsible for cleaning the tanks (APTIM) has line authority over the safety of the project. The Navy Closure Task Force (NCTF) will provide safety oversight as part of quality assurance (QA).

2. ***Section 4 DFOW, “Install liner access system”- It is unclear what is meant by “liner access system.” Is this referring to the scaffolding and boom? Please clarify.***

The “liner access system” refers to the booms and suspended scaffold baskets used to place workers next to the tank liner during pressure washing. This process has been successfully used by APTIM on prior Clean, Inspect, Repair (CIR) projects for Tanks 1, 5, 13, 14, 17 and 18. The photo below shows two booms and two suspended baskets holding personnel performing CIR work.

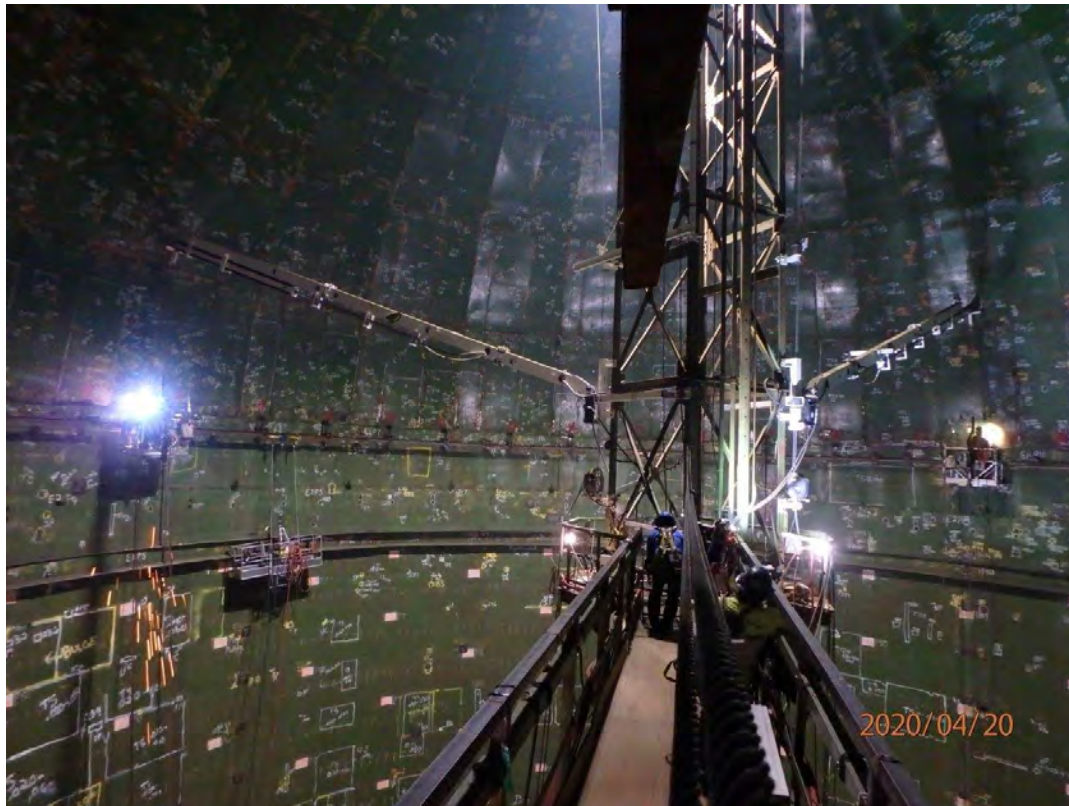

3. ***Section 4.2, 1(d) & (e) - Provide the location of where concrete pads for equipment and vehicles will be installed. A drawing should be used to outline the proposed site locations.***
In the revised Project Work Plan dated December 2023, APTIM has provided a general map showing the proposed location of the additional concrete pads. See Figure 4-1B in the Project Work Plan (Attachment 4) for locations of additional paved parking and concrete pad.
4. ***Section 4.2 Electric vehicles, equipment, and lighting systems – Please confirm that all equipment used during tank cleaning is rated for the electrical classification area inside the***

tanks. Use of electric vehicles will require approval by fire marshal or other appropriate parties. NCTF will confirm all electrical equipment inside the tanks is rated for the proper electrical classification.

5. ***Section 4.2, 14, “Close tank with the new lockable steel door which will not be airtight” - Please provide the rationale for using non-airtight, lockable steel doors. While EPA does not disapprove of the use of these doors, it is unclear why this specification was made.***

The door is not intended to be air-tight because the tank will be receiving ventilation, and that level of integrity is no longer required. The bolted, airtight, 8-foot diameter cover will be replaced with a lockable steel door to prevent unauthorized entry but still allow relatively easy access for any necessary inspections. The replacement cover will include a hinged, lockable, fabricated steel door. The Navy Closure Task Force (NCTF) will submit the shop drawing to EPA prior to fabrication.

6. ***Section 4.2.1 Tank Access – This section refers to out-of-date standards. API Recommended Practice 2016 has been merged with API Standard 2015. The latest edition of API Standard 2015 should be referred to in this work plan. Please confirm applicable standard.***

The Navy concurs, and the work will conform to the latest API Standard 2015 as noted.

7. ***Section 4.2.4.1 Tank Degassing – The work plan does not specify the LEL and VOC threshold for safe entry. What levels will VOCs and LEL be reduced to during degassing, and what is the basis for these concentrations? Additionally, does Navy have historic VOC data from previous tank cleanings that can provide an expected baseline concentration of an empty tank? EPA recommends testing VOCs prior to the commencement of degassing if anticipated concentrations are unknown.***

APTIM has historic data from previous tank cleaning efforts that show initial readings of approximately 100 ppm VOCs. As recommended for the current effort, APTIM will obtain a baseline VOC reading prior to the start of ventilating the tank (also referred to as “degassing”). During ventilation, the Marine Chemist (Industrial Hygienist) will determine the safe VOC levels in accordance with ACGIH and NIOSH standards for worker entry with appropriate PPE. As sludge is removed, the ventilation (degassing) process will continue to reduce VOC and LEL levels inside the tank.

8. ***Section 4.2.4.1 Tank Ventilation, “A 200 HP fan will be staged outside to pull the necessary 10,000 CFM per tank...” - The specified rate results in one exchange of air within each tank approximately every two hours. What is the basis for concluding 10,000 CFM is the necessary ventilation rate? Please provide supporting calculations. Additionally, Figure 4-4 references a 150 HP fan will be used. Please clarify and/or reconcile.***

The Project Work Plan has been revised to state “A 200 HP fan will be staged outside rated to exhaust at 90,000 CFM during ventilation (degas) operations.” Figure 4-4 in the work plan has been revised to show a 200 HP ventilation fan. In addition, a 10,000 CFM supply-air blower will be staged in the lower access tunnel, with connection to the 20-inch diameter tank nozzle to supply fresh air for confined space entry. The basis for the 10,000 CFM ventilation rate comes from the Unified Facilities Guide Specifications (UFGS) UFGS 33 01 50.55 “Cleaning of Petroleum Storage Tanks,” which calls for 10,000 CFM for tanks the size of the Red Hill bulk fuel storage tanks.

9. ***Section 4.2.4.1, “The piping in the lower tunnel will be disconnected in each alcove...” - Pipe openings created by disconnecting the pipeline laterals from the tank skin valves should be***

properly sealed to ensure any residual material cannot escape the piping system. If piping is expected to contain hazardous material, capping of the line needs to meet all local, state, and federal requirements. Please describe what method will be used to cover pipe openings following disconnection. Any capping must allow for the complete cleaning of pipelines (see comment 10, below).

Following disconnection of the piping, NCTF proposes to install bolted blind flanges with gaskets to cover both ends of the pipe openings inside and outside of the tank after the piping has been ventilated to evaporate any residual fuel.

- 10. Section 4.2.4.1 Tank standpipe and encased pipeline cleaning – It is unclear how Navy intends to clean the fuel pipeline extending from the bottom of the tank to a point within the tank (i.e., standpipe), and the portion of pipeline between the standpipe and the skin valve. Please provide the anticipated method that will be used to clean this line.**

A 10,000 CFM supply-air blower will be connected to the 20-inch diameter tank nozzle to supply fresh air through the standpipe for confined space entry. NCTF proposes this ventilation as part of the method to be used to clean this segment of pipeline since it will remain in place and is too small to allow safe access for a human being to clean the inside of the pipe. Pipeline cleaning outside of the tank will be completed under the pipeline removal contract.

- 11. Section 4.2.4.1, “[A] structural engineer from Hawaii Engineering Group (HEG) will inspect existing tank catwalk and center tower infrastructure for deficiencies” - Due to the specialized nature of this work, EPA would like to reiterate the importance of having a licensed structural engineer (S.E.) inspect and approve of the existing and newly installed structures to ensure the safety of all tank cleaning personnel. EPA requests that all inspection reports, conditions assessments, and recommendations from an S.E. be provided for review.**

A licensed structural engineer will inspect and approve repairs to ensure safety of tank cleaning personnel. Inspection reports and summary of repairs will be submitted to the EPA for review and concurrence using a similar process as was used by the Joint Task Force-Red Hill (JTF-RH).

- 12. Section 4.2.4.1, “Drums of sludge will be stored in an adjacent alcove within secondary containment” – It is not clear if this refers to a specific alcove or the area adjacent to each tank. Please provide further detail on the location and the space available for storage of 55-gallon drums. Section 5.1 of the Environmental Protection Plan notes that the typical transport truck can hold 30-40 drums, and this quantity should serve as the maximum stored on site at one time. Will there be sufficient storage in the alcove(s) for this quantity of drums? Based on Navy’s estimates, EPA calculates that approximately 55 drums will be generated per tank, or 800 drums in total, for all fuel storage and surge tanks.**

Drums will be stored in alcoves near the tanks being cleaned. For example, when cleaning Tanks 15 and 16, Drums will be stored in secondary containment at Tanks 13 and 14 (or at Tanks 17 and 18). As noted above, 30-40 drums will be the maximum ordinarily stored on site at one time. Individual drums will not be filled to 55 gallons, and proper headspace will be provided. APTIM will manage containers in accordance with appropriate federal, state, and local regulations.

- 13. Section 4.2.4.1, “Only a visual inspection will be required for a tank to be constituted as ‘clean’” – EPA continues to work with Navy on identifying an acceptable method to certify tank cleanliness. EPA does not agree that visual inspection alone will be a sufficient means of verifying the “removal of all product, vapor, sludge and residual from a tank”. Please continue to**

provide updates and submit a tank cleaning verification plan to EPA once an acceptable method has been determined. When this tank cleaning verification plan is submitted, please address how it will be applied to Red Hill tanks 1, 5, 13, 14, 17 and 18 previously emptied and/or cleaned.

The Navy will submit a tank cleaning verification plan to EPA according to the timeline shown in the Integrated Master Schedule (IMS) dated 15 December 2023 (Attachment 1). As requested, the plan will address how the verification method will be applied to Tanks 1, 13, 14, 17, 18, and 19, which were cleaned previously and are currently empty.

Response to EPA Comments on Environmental Protection Plan with Spill Response Plan

- 1. Section 5.1 “Rainwater shall be collected in appropriate containers and treated as if it contains contaminants” - The document indicates that stormwater will be diverted from wastes and that, the extent possible, wastes will be covered. Where does Navy expect potentially contaminated rainwater to accumulated? Please clarify.***

The objective is to maintain a cover over all waste containment areas, but if any areas are uncovered, accumulation of rainwater will occur in secondary containment. In this case, water will be removed and properly disposed of in accordance with state, federal and local regulations.

- 2. Section 5.1, “The typical transport truck supplied to transfer drummed waste off-site can hold 30-40 drums. This quantity should serve as the maximum stored on site at one time allowing for the regular removal of waste from the job site” - How many stored drums can be safely managed onsite in the event there is an interruption in regular removal of the waste?***

There is adequate storage capacity on site for more than 300 drums. However, no more than 40 drums are expected to be stored on site at any one time.

- 3. Section 5.1, “Once the sludge has passed all tests and been determined to be nonhazardous, it will be disposed of in a sanitary landfill” - Not all sanitary landfills are capable or permitted to accept petroleum contaminated sludges. Please identify the specific landfill(s) and confirm the chosen landfill(s) is permitted to receive petroleum sludges and has capacity for the total estimated amount of waste to be generated. EPA calculated the potential number of 55-gallon drums from Navy estimates of 3,000 gallons for each of 14 Red Hill tanks and 500 gallons for each of four sludge tanks. Please confirm this assumption.***

The NCTF is submitting the revised the Waste Management Plan to identify potential permitted disposal facilities. Entities such as the Clean Harbors Waste Management System arrange these details upon receiving documentation (e.g., laboratory analyses). NCTF will confirm the selected facility and provide this information to EPA prior to disposal activities.

- 4. Section 5.2.1, “Hazardous waste disposal shall be performed at a permitted off-island treatment, storage, and disposal facility” - Please identify the specific off-island disposal facility or facilities that will receive hazardous wastes generated during the tank cleaning project.***

The NCTF is submitting the revised the Waste Management Plan to identify potential permitted disposal facilities. Entities such as the Clean Harbors Waste Management System arrange these details upon receiving documentation (e.g., laboratory analyses). NCTF will confirm the selected facility and provide this information to EPA prior to disposal activities.

- 5. Section 5.2.2 - Please identify the specific off-island and on-island disposal facility or facilities that will receive hazardous wastes generated during the tank cleaning project.***

The NCTF is submitting the revised the Waste Management Plan to identify potential permitted disposal facilities. Entities such as the Clean Harbors Waste Management System arrange these details upon receiving documentation (e.g., laboratory analyses). NCTF will confirm the selected facility and provide this information to EPA prior to disposal activities.

6. ***Section 6.2, “Containment is a catchment area around the potential release source capable of capturing all the contaminants, typically 110% of the largest quantity or container” - Freeboard for precipitation should also be considered for outdoor applications that are not fully covered. Please confirm that either the containment will be covered or there is sufficient capacity to account for precipitation.***

The objective is to cover all waste containment areas, but any uncovered areas will have adequate capacity for precipitation. The Waste Management Plan identifies the freeboard to accommodate precipitation. When removing liquids from secondary containment, APTIM will use a vactor truck for large containments outside, and hand pumps or absorbents for small containments inside the facility.

7. ***Section 6.3, “To control the spread of a spill, the project will evaluate the use of diversion barriers to create spill ways to direct the release away from critical infrastructure such as sumps or drains. The project site is designed to flow fuel downgradient” - To the extent possible, diversion barriers should avoid creating spill ways that are over soil and instead direct them to paved or concrete surfaces that are relatively impermeable. Please confirm this strategy will be incorporated into the plan.***

Diversion barriers will be used in a similar manner as was utilized by JTF-RH to direct any potential release away from spill ways leading to soil and instead towards paved or concrete surfaces but also away from potential pathways to the environment. Prior to beginning the work, the site will be evaluated to identify potential hazards and implement control measures around monitoring wells and barricades around generator fuel tanks. The NCTF will incorporate this strategy into the plan.

8. ***Section 6.4, Sources of Spills, Tank wash water – As described in Section 4.2.4.1 of the Work Plan, all internal structures of the tank interiors will be pressure washed with a mixture of freshwater and Simple Green all-purpose cleaner, then pressure washed again with freshwater. If tank wash water containing Simple Green or other surfactants were released to the subsurface, it could remobilize petroleum from previous spills, mobilize any petroleum bound to concrete between the metal tank wall and the mountain, and/or cause petroleum to migrate unpredictably. Rinsate water should be completely captured, assuring it does not impact existing environmental conditions. Please clarify how Navy will mitigate this risk and verify that the volume of water used to clean each tank is equal to the volume of rinsate recovered in Tank 311?***

NCTF will maintain a daily logbook comparing the volume of water used from the storage tank to the increase in level in Tank S311 (i.e. where rinsate will be discharged) to confirm there is not a gross loss of water. However, differences are anticipated between the daily volume of water used and the daily volume of water collected due to the cyclic nature of operation of the main sump pumps.

9. ***Section 6.4, Sources of Spills, FOR pipeline, “Perform visual inspection at necessary intervals during project timeline” - How will “necessary intervals” be determined? EPA recommends scheduled or routine inspection intervals be used instead.***

Both the NCTF and APTIM will visually inspect the FOR system integrity at least daily.

- 10. Section 6.6, “A spill response kit shall contain any applicable tools, equipment, or material necessary for the initial containment and cleanup of a release until additional support can respond to the location. All spill kits at a minimum shall contain the following supplies...” - EPA recommends that in addition to the spill kit supplies listed, drain cover seals also be included to augment berms for preventing entry into stormwater drains and drywells.**

Spill mitigation will include drain cover seals to augment berms for preventing spill entry into stormwater drains and drywells. NCTF will apply the same approach that was used successfully during defueling.

Response to EPA Comments on Waste Management Plan

- 1. Section 4.0 Waste testing requirements – EPA recommends using knowledge gained during previous tank cleaning operations to help inform and expedite classification of hazardous waste. If waste streams have previously been deemed hazardous, Navy may choose to forego testing and preemptively classify the waste as hazardous.**

During previous tank cleaning efforts, the waste was characterized as non-hazardous. However, waste will continue to be tested to determine whether it is hazardous or non-hazardous.

- 2. Section 9.3 Table 5, “If the less than 90-day accumulation area is not covered...” - Section 5.2 of the Environmental Protection Plan indicates “containers of liquid must be stored on adequate secondary spill containment under shelter”. This commitment appears inconsistent with the language presented in Table 5 of the Waste Management Plan. Please clarify and/or reconcile the language of the two documents.**

Section 5.2 of the Environmental Protection Plan has been revised for consistency. The revisions state that containers will be under cover when possible, and if not covered, secondary containment will include freeboard for rainwater.

- 3. Due to age and historic use of the facility, it is likely that some storage tanks may have contained different products than the ones most recently held. Best practices suggest the tanks would have been cleaned before the introduction of a new product to avoid contamination. However, it is unknown if residual material from previous products may still be present. Please confirm that tanks have been cleaned prior to storage of the most recent products.**

The figure below provides a rough summary of the approximate history of fuel storage at Red Hill. So far, the Navy has not found records pertaining to the history of tank cleaning prior to a change in fuel type, so we cannot yet confirm such cleaning occurred. NCTF believes, based on the following table, that only POL products have been stored inside the tanks and that cleaning and disposal requirements will address any fuel types that have been historically stored inside the tanks.

Responses to 20 NOV 2023 EPA Comments on Clean Fuel Storage Tanks for Closure

| | 1943 - 49 | 1950s | 1960s | 1970s | 1980s | 1990s | 2000s | 2010s | 2020-2023 |
|--------|-----------------------|-------|-------------------|---------------------|-------------------|-------|---------------------|--------------------|--------------------|
| UST-1 | Diesel ¹ | | | Diesel ⁴ | | | Empty ⁹ | | |
| UST-2 | Diesel ^{1,7} | | | Diesel ⁴ | | | JP-8 ⁷ | F-24 ⁸ | F-24 ⁹ |
| UST-3 | NSFO ^{2,7} | | | Diesel ⁴ | | | JP-8 ⁷ | F-24 ⁸ | F-24 ⁹ |
| UST-4 | NSFO ^{2,7} | | | Diesel ⁴ | | | JP-8 ⁷ | F-24 ⁸ | F-24 ⁹ |
| UST-5 | NSFO ^{2,7} | | | Diesel ⁴ | | | JP-8 ^{6,7} | F-24 ⁸ | F-24 ⁹ |
| UST-6 | NSFO ^{2,7} | | | Diesel ⁴ | | | JP-5 ¹⁰ | F-24 ⁸ | JP-5 ⁹ |
| UST-7 | NSFO ^{2,7} | | | Diesel ⁴ | | | JP-5 ¹⁰ | JP-5 ⁸ | JP-5 ⁹ |
| UST-8 | NSFO ^{2,7} | | | Diesel ⁴ | | | JP-5 ¹⁰ | JP-5 ⁸ | JP-5 ⁹ |
| UST-9 | NSFO ^{2,7} | | | Diesel ⁴ | | | JP-5 ¹⁰ | JP-5 ⁸ | JP-5 ⁹ |
| UST-10 | NSFO ^{2,7} | | | Diesel ⁴ | | | JP-5 ¹⁰ | JP-5 ⁸ | JP-5 ⁹ |
| UST-11 | NSFO ^{2,7} | | | Diesel ⁴ | | | JP-5 ¹⁰ | JP-5 ⁸ | JP-5 ⁹ |
| UST-12 | NSFO ^{2,7} | | | Diesel ⁴ | | | JP-5 ¹⁰ | JP-5 ⁸ | JP-5 ⁹ |
| UST-13 | NSFO ^{2,7} | | | Diesel ⁴ | | | Diesel ⁴ | Empty ⁸ | Empty ⁹ |
| UST-14 | NSFO ^{2,7} | | | Diesel ⁴ | | | Diesel ⁴ | Empty ⁸ | Empty ⁹ |
| UST-15 | NSFO ^{2,7} | | | Diesel ⁴ | | | Diesel ⁴ | F-76 ⁸ | F-76 ⁹ |
| UST-16 | NSFO ^{2,7} | | | Diesel ⁴ | | | Diesel ⁴ | F-76 ⁸ | F-76 ⁹ |
| UST-17 | NSFO ² | | JP-5 ³ | JP5 ⁷ | JP-5 ⁴ | | JP-8 ⁵ | Empty ⁸ | Empty ⁹ |
| UST-18 | NSFO ² | | JP-5 ³ | JP5 ⁷ | JP-5 ⁴ | | JP-8 ⁵ | JP-5 ⁸ | Empty ⁹ |
| UST-19 | NSFO ² | | AG ^{3,7} | JP5 ⁷ | JP-5 ⁴ | | Empty ⁹ | | |
| UST-20 | NSFO ² | | AG ^{3,7} | JP5 ⁷ | JP-5 ⁴ | | JP-5 | JP-5 ⁸ | JP-5 ⁹ |

Notes
 NSFO - Navy Special Fuel Oil
 JP-5 - Jet Propellant-5
 JP-8 - Jet Propellant-8
 F-76 - MIL-SPEC distillate fuel
 AG - Aviation Gas

ATTACHMENT 3: POST AWARD KICKOFF MEETING AGENDA - CLEAN
RED HILL TANKS - REDACTED

[RETURN TO TABLE OF CONTENTS](#)



POST AWARD KICKOFF (PAK) MEETING

CLEAN RED HILL TANKS, JOINT BASE PEARL HARBOR-HICKAM, HAWAII

Contract No. N39430-20-D-2225 Task Order N3943020F4645

Date/Time: Wednesday 4 October 2023 @ 0830 HST (Partnering Meeting to Follow)

Location: Pearl 2 Meeting Room; Pearl Country Club; 98-535 Kaonohi St, Aiea, HI 96701

Conference Call #: [469-270-0551](tel:469-270-0551) Passcode: 655121170#

Personnel Invited (Highlighted Names Attended):

NAVFAC HI/JTF

[Redacted]

CLOSURE TEAM

[Redacted]

NAVFAC EXWC

[Redacted]

NAVSUP FLC-PH

[Redacted]

DLA Installation Support

[Redacted]



APTIM

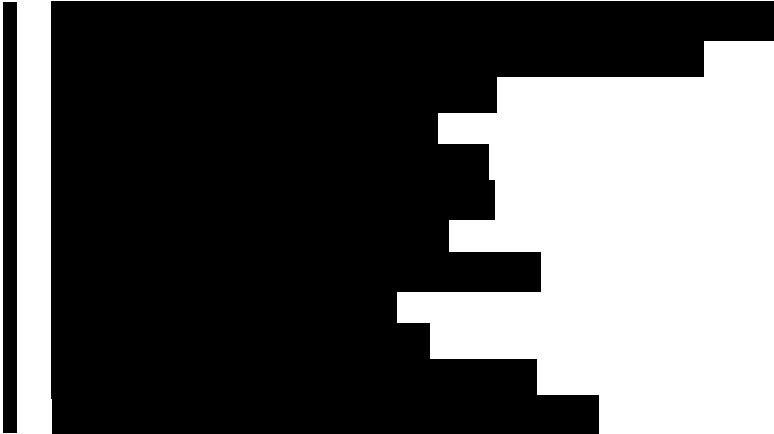

AGENDA

Team Introductions

Introduction/Meeting Purpose: The objective of this Post Award Kick-off (PAK) meeting is to discuss the planned **pre-construction activities** up to mobilization, and to facilitate general discussion of overall tank cleaning activities.

Agenda Items

The following items will be discussed as part of this PAK Meeting:

- Introduction
- Project Scope Summary
- Communications / Org Chart / Roles and Responsibilities
- Preconstruction (Division 1) Submittals
- Badging, Permits, Entry Authorization, & Notification Requirements
- Health and Safety
- Environmental
- Open Discussion

1. Project Scope Summary

The primary objectives of this Project Program are to clean 14 bulk storage tanks, four surge tanks, and two sumps at the Red Hill Bulk Fuel Storage Facility (RHBFSF) tank farm. This scope of work includes but is not limited to: mobilization and installation of infrastructure, installation of ventilation systems for tank de-gassing/tank ventilation, installation of tank access systems, sludge/debris removal, and cleaning of the interior surfaces and appurtenances in each tank.

2. Communications

- Contractual Submittals and Correspondences sent to ACQ/CM/ET
- Pre-Construction Meeting planned for prior to mobilization
- All communications with the KTR must be done through COR/KO
- Only the KO can direct changes in scope



3. Critical Division 1 Submittals

- Approved Submittals
 - o Waste Management Plan
 - o Environmental Protection Plan, Spill Response Plan (official transmittal forthcoming)
- Received Government Comments—Work Plan

4. Summary Level Schedule Overview

Pre-Construction Milestones:

| | |
|-------------|----------------------------------------------------|
| 10 Dec 2024 | All Pre-Construction Submittals approved. |
| 15 Jan 2024 | All Ventilation System components installed/tested |
| 19 Jan 2024 | All Access Systems in place and tested |

NOTE: Dates and major milestones have been revised and will be provided in DOH response.

Major Milestones for Tank Cleaning:

| | |
|-------------|-------------------------------------------|
| 19 Jan 2024 | Transition from Defueling to Closure |
| Sep 2026 | Cleaning complete |
| Dec 2026 | Documentation and demobilization complete |

Milestones for cleaning the first two tanks:

| | |
|----------------|------------------------------------------------------------------------|
| Early FEB 2024 | Complete Disconnect pipelines from tank nozzles |
| Early FEB 2024 | <u>Begin initial degassing</u> / tank ventilation |
| Mid-FEB 2024 | Complete Flood tank bottoms to float flowable sludge into the FOR line |
| Late FEB 2024 | Complete Remove 8-ft manway/install temporary entry door |
| Early MAR 2024 | Complete Install tank lighting |
| Mid-MAR 2024 | Complete Install center tower access system |
| Late MAR 2024 | Complete Remove non-flowable sludge from tank bottoms |
| Late MAR 2024 | Complete Structural Inspection center tower & catwalk |
| Early MAY 2024 | Complete Perform center tower & catwalk repairs for boom installation |
| Mid-JUN 2024 | Complete Install booms and baskets for tank shell access |
| Late JUN 2024 | Complete Set up pressure washing system (electrical, pumps, sprayers) |
| Early AUG 2024 | Complete Pressure wash tanks |
| Mid-AUG 2024 | Complete Clean and dry tank bottoms |

5. Badging, Permitting, Entry Authorization, and Notification Requirements

Badging / Entry Authorization

- Master Access List
- Red Hill Badges
 - New Applicants, OF306 Form, Contractor Request Form for SF 85
 - Renewal Spreadsheet
- DBIDS
- Photo Permits



Notification Requirements

- Daily Activity Correspondence to NAVFAC ACQ/COR/CM/ET
- Accidents/Incidents – prompt notification to NAVFAC COR/KO/ET via phone with email correspondence to follow
- Release of contaminants to the environment - immediate notification to NAVFAC COR/CM/KO/ET via phone with email correspondence to follow
- Construction shutdown due to facility operations notification received from NAVFAC COR/KO
- Normal work hours at the Red Hill Complex: 0600 to 1630. APTIM can request extended hours or weekend work when necessary for work.
 - Off hour request will be granted on a case-by-case via phone with NAVFAC COR/KO
 - Weekend Work must be submitted by Thursday morning for approval

6. Health and Safety

Complete details of all health and safety (H&S) provisions are included in the project APP. APP prepared IAW EM-385-1-1, OSHA, and APTIM Guidelines. All project activities will be performed in compliance with the current safety requirements.

- Safety Orientation - All project personnel including subcontractor's personnel shall attend a safety orientation meeting prior to working on the project site. To include the following elements:
 - Review and sign-off of the Final APP
 - SSHO to review all Activity Hazard Analyses (AHAs) applicable to project start up (additional AHAs will be reviewed prior to starting that activity)
 - Review and approval of all APTIM and subcontractor H&S training and certifications by the Project HSM.
- Site-Specific Training – Performed in conjunction with Safety orientation or on an as-needed basis. Topics to include HAZCOM, Confined Space, Fall Protection, etc
- Daily Safety Tailgate Meeting – Conducted by the SSHO every day prior to work. To include review of H&S associated with planned activities. Based around the JSA/AHA concept.
- Personal Protective Equipment (PPE)
 - The EM-385 requirements for PPE will be followed.
 - Varies for each feature of work – detailed in the APP and AHAs.
 - Subcontractors responsible for providing their own PPE
 - All personnel in Level C must have annual respirator fit test (otherwise Project HSM to perform)
- Monthly Safety Submittals
 - Contractor Safety Evaluation Checklist to be submitted with the monthly invoice
- Emergency Response
 - 9-1-1 (when calling 911, need to indicate that you are located on base)
 - First responder – Naval Base Fire Dept



7. Environmental

- Waste Management
- APTIM Environmental Managers will be as designated by Environmental Protection Plan, (Richard Lewis, Maura Mastriani, Austin White) and the onsite HSEM.
 - Atmosphere air monitoring will be performed by APTIM's SSHO to ensure safe confined space entry procedures and welding conditions per Marine Chemist Certificates and Fed Fire Hot Work Permit; Outside 3rd party monitoring may be required for lead monitoring if applicable.
 - DOH determination of permit requirements – application submitted for generator emissions; no permit required for degassing/ventilation systems

8. Open Discussion

- Tunnel Access
- Confined Space Entry Procedures and Fall Protection Certifications for all visitors

ATTACHMENT 4B: PROJECT WORK PLAN - REDACTED

[RETURN TO TABLE OF CONTENTS](#)



DECEMBER 2023

PROJECT WORK PLAN

Clean Red Hill Tanks JBPHH, Hawaii

Joint Base Pearl Harbor-Hickam Oahu, Hawaii

Naval Facilities Engineering
[Redacted]

[Redacted]

Revision 0

Submitted by:

[Redacted]

Table of Contents

| | | |
|---------|------------------------------------------------------------|----|
| 1 | Introduction | 1 |
| 1.1 | Project Summary | 1 |
| 1.2 | Project Background | 1 |
| 1.3 | Project Location..... | 2 |
| 2 | Project Sequence and Schedule..... | 4 |
| 3 | Drawings and Specifications | 6 |
| 4 | Methodology and Execution Strategy | 7 |
| 4.1 | Pre-Construction Activities | 8 |
| 4.1.1 | Post Award Kickoff Meeting..... | 8 |
| 4.1.2 | Pre-Construction Meeting..... | 8 |
| 4.1.3 | Permitting, Passes, and Notification Requirements..... | 8 |
| 4.1.3.1 | Base Work Clearance and Entry Authorizations | 9 |
| 4.1.3.2 | Hot Work Permit..... | 9 |
| 4.1.3.3 | Confined Space Entry Permit..... | 9 |
| 4.1.4 | Mobilization and Site Preparation General Activities | 9 |
| 4.2 | Field Activities | 11 |
| 4.2.1 | Tank Access..... | 12 |
| 4.2.1.1 | Central Tower & Catwalk Inspection | 13 |
| 4.2.1.2 | Access Equipment | 13 |
| 4.2.2 | Provision of Utilities | 14 |
| 4.2.3 | Repair Design..... | 15 |
| 4.2.4 | Tank De-Gassing, Access Setup and Cleaning..... | 16 |
| 4.2.4.1 | RHBFUSF TANKS | 16 |
| 4.2.4.2 | Surge Tanks..... | 21 |
| 4.2.4.3 | Sump Pits..... | 22 |
| 4.2.5 | Work Completion Walk Through..... | 22 |
| 4.3 | Post-Construction Project Activities | 23 |
| 4.3.1 | Demobilization, Waste Handling, and Work Completion | 23 |
| 5 | Key Project Personnel | 24 |
| 5.1 | Project Team Responsibilities | 24 |
| 5.1.1 | Project Manager | 24 |
| 5.1.2 | Construction Manager (Site Superintendent) | 25 |
| 5.1.3 | Quality Control Manager..... | 25 |
| 5.1.4 | Site Safety and Health Officer | 25 |
| 6 | Subcontractors..... | 26 |
| 6.1.1 | Designer of Record | 26 |
| 6.1.2 | Mechanical and Piping Subcontractor | 26 |
| 6.1.3 | Tank Cleaning/Waste Rinsate Disposal | 26 |
| 6.1.4 | Structural Engineering..... | 26 |
| 6.1.5 | Lead/asbestos Competent Person | 26 |

List of Tables

Table 5-1 Key Project Personnel
Table 6-1 Subcontractors

List of Figures

Figure 1-1 Project Location Red Hill
Figure 1-2 Project Location JBPHH Surge Tanks
Figure 4-1A General Site Layout Red Hill
Figure 4-1B ADIT 4 Proposed Layout of [REDACTED] Laydown Area
Figure 4-2 General Site Layout Surge Tanks
Figure 4-3 Power Schematic
Figure 4-4 Ventilation Schematic
Figure 4-5 Shell Access System
Figure 4-6 Surge Tank Line Diagram

List of Appendices

Appendix A Generic Shell Layout Map (Tank 17)
Appendix B Personnel Resumes And Certifications
Appendix C SDS and Cut Sheets

Acronyms and Abbreviations

| | |
|-------------|---------------------------------------------------------------|
| API | American Petroleum Institute |
| APP | Accident Prevention Plan |
| CM | Construction Manager |
| CMC | Certified Marine Chemist |
| CO | Contracting Officer |
| CQCP | Construction Quality Control Plan |
| DOR | Designer of Record |
| DQCP | Design Quality Control Plan |
| EPP | Environmental Protection Plan |
| ET | Engineering Technician |
| FEAD | Facilities, Engineering, & Acquisition Division |
| FOR | Fuel Oil Recovery |
| IAW | in accordance with |
| JBPHH | Joint Base Pearl Harbor-Hickam |
| LEL | Lower Explosive Limit |
| NACE | National Association of Corrosion Engineers |
| NAVFAC EXWC | Naval Facilities Engineering and Expeditionary Warfare Center |
| NAVFAC HI | Naval Facilities Engineering Command, Hawaii |
| Navy | U.S. Department of the Navy |
| NDE | Nondestructive Examination |
| NWGLDE | National Work Group on Leak Detection Evaluations |
| NTR | Navy Technical Representative |
| OSHA | Occupational Safety and Health Administration |
| PAK | Post Award Kickoff |
| PCS | Pacific Commercial Services |
| PM | Project Manager |
| QC | Quality Control |
| RFP | Request for Proposal |
| RHBFUSF | Red Hill Bulk Fuel Underground Storage Facility |
| RP | Recommended Practice |
| SOW | Statement of Work |
| SSHO | Site Safety & Health Officer |
| SSWP | Site Specific Work Plan |
| TO | Task Order |
| UFC | Unified Facilities Criteria |
| UFGS | Unified Facility Guide Specifications |
| VOC | Volatile Organic Compound |
| WP | Work Plan |

1 Introduction

1.1 Project Summary

[REDACTED] will perform this work under Task Order [REDACTED] Contract No. [REDACTED] entitled, Naval Facilities Engineering and Expeditionary Warfare Center (NAVFAC EXWC) “Clean Red Hill Tanks Joint Base Pearl Harbor Hickam, Hawaii”, dated May 23, 2023.

This Work Plan (WP) describes the technical and project management efforts, field work procedures, general requirements, materials, equipment, and sequence/schedule to complete cleaning of 14 tanks at Red Hill and four surge tanks at Joint Base Pearl Harbor-Hickam (JBPHH). The objective of this project is to clean 14 tanks at Red Hill, four surge tanks, and the main sump and sump 7 at Joint Base Pearl Harbor-Hickam (JBPHH) as part of the de-commissioning effort of the fuel facility.

1.2 Project Background

The Red Hill Bulk Fuel Underground Storage Tank Facility (RHBFUSF) tanks were mined in-place below a homogeneous basalt ridge located between Moanalua Valley and Halawa Valley on the island of Oahu. Construction was completed in September 1943. Access to the tanks is provided through a single upper access tunnel 190 feet above each tank bottom, and a lower access tunnel just below the tank bottom. The lower tunnel extends about three miles to an underground pump house at Pearl Harbor. These unique tanks were mined-in-place to provide protection from aerial attack. The depth from the top of the 250-foot tall tanks to the surface varies from approximately 110- to approximately 175-feet. The fuel tanks vent to atmosphere. The shell (lower dome, floor, barrel, and upper dome) is lined with butt-welded carbon steel, nominal 1/4-inch thickness (except for a portion at the bottom of each tank which is lined with 1/2-inch thick steel shell or liner plates). The tank liner is enclosed within layers of reinforced concrete, grout, gunite, and consolidation grout. At the top of the tank (the upper dome), thickness of this concrete varies from 2-feet at the top to 8-feet at the base. Through the middle section of the tank (also known as the barrel region) concrete ranges in thickness from 2.5-feet at the top to 4-feet at the bottom. At the bottom of the tank (the lower dome), a massive plug of reinforced concrete, in some places 18-feet thick, was placed beneath the tank to brace the center tower. No petroleum tank construction standard was in existence for this work due to the unique location requirements. The Government has no material specifications or standards for the existing carbon steel plate.

1.3 Project Location

The RHBFUSF tanks are located within the Red Hill Fuel Facility on a ridgeline on the southeast side of the Halawa Valley containing an array of twenty bulk fuel storage tanks, in which is what is called the tank gallery. Tank 1 is the nearest of any tank to Adit 4, an entrance into the facility to the upper tunnel and Tanks 15 & 16 are tanks located closest to ADIT 5. A location map is provided in **Figure 1-1** below. The four surge tanks are located on JPBHH proper, just East of ADIT 1. See **Figure 1-2** below.

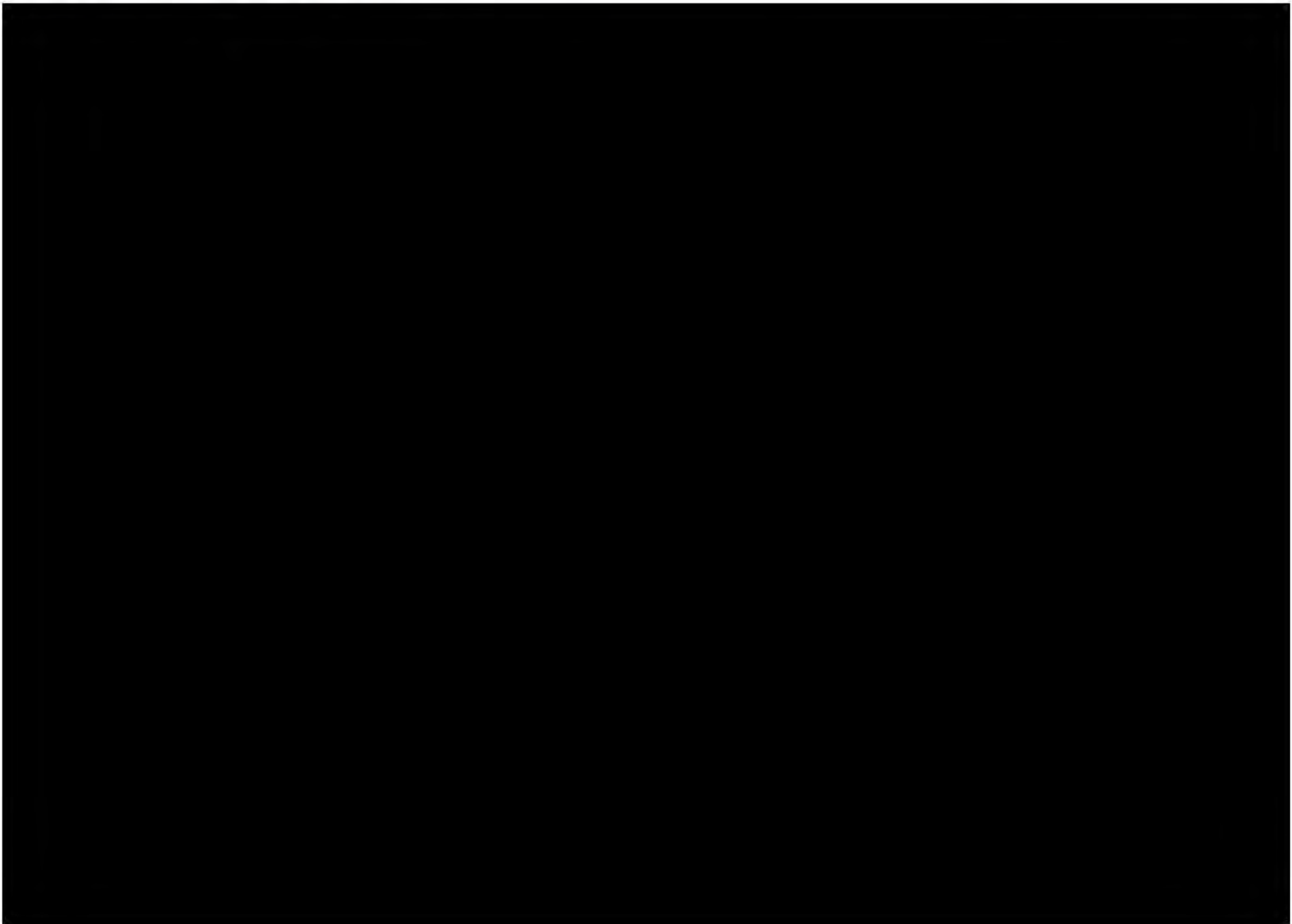

Procurement sensitive and proprietary information – This information is exempt from disclosure under 5. U.S.C. § 552(b)(4) because it contains proprietary and procurement sensitive information.

DCRIT determination for RH – This information is exempt from disclosure under 5 U.S.C. § 552(b)(3) because it meets the requirements for exemption under 10 U.S.C. § 130e.



2 Project Sequence and Schedule

██████████ anticipates completing all project activities by December 2026, within the period of performance for ██████████. The government has stated that the tanks will be available for entry and de-gassing to prepare for cleaning on January 22, 2024. The below excerpt from the project schedule indicates the currently proposed tank sequence for the cleaning. This sequencing is subject to change as plans and layout for de-gassing throughout the tank gallery is finalized with the ██████████.

| Activity ID | Activity Name | Orig Dur | Rem Dur | Est Dur | % Comp | Start | Finish | Total Float | Subcontractors | Govt Layout with Successors | Data Date - 10-Jun-23 | Run Date/Time - 28-Aug-23 17:40 | |
|-------------------------------|--------------------------------|------------|------------|----------|--------|------------------|------------------|-------------|----------------|----------------------------------------------------------------------------------------------------------------------------------------|-----------------------|---------------------------------|--|
| Total | | 867 | 867 | 0 | | 30-Jan-23 | 26-Dec-26 | 0 | | | | | |
| Red Hill Tank Cleaning | | | | | | | | | | | | | |
| CAWD | Contract Award | 0 | 0 | 0 | 0% | 30-Jan-23 | | | 13 | PAK010, S50100, PC0120, PC0130, PC0180, PC0190, PC0220, PC0250, PC0280, PC0310, PC0340, PC0370, PC0400, PC0430, PC0460, PC0490, PC0570 | Contract Award | | |
| PAK010 | PAK Meeting | 1 | 1 | 0 | 0% | 21-Sep-23 | 21-Sep-23 | 68 | PRECON | PAK Meeting | | | |
| PRECON | Pre-Construction Meeting | 1 | 1 | 0 | 0% | 08-Jan-24 | 08-Jan-24 | 17 | TK16-0100 | Pre-Construction Meeting | | | |
| CAWD10 | Construction Duration (WDAY) | 655 | 655 | 0 | 0% | 16-Jan-24 | 26-Aug-26 | 28 | TK02-0420 | Construction Duration | | | |
| PCD | Project Completion Date | 1 | 1 | 0 | 0% | 01-Dec-26 | 01-Dec-26 | 13 | CCD | Project Completion | | | |
| PDR | Project Duration (CDAY) | 1251 | 1251 | 0 | 0% | 30-Jan-23 | 01-Dec-26 | 17 | PCD | Project Duration | | | |
| CCD | Contract Completion Date | 0 | 0 | 0 | 0% | | 20-Dec-26 | 0 | | Contract Complete | | | |
| Project Milestones | | | | | | | | | | | | | |
| W0000016 | Tank 16 Duration | 174 | 174 | 0 | 0% | 16-Jan-24 | 25-Sep-24 | 82 | TK16-0420 | Tank 16 Duration | | | |
| W0000012 | Tank 12 Duration | 174 | 174 | 0 | 0% | 16-Jan-24 | 25-Sep-24 | 82 | TK12-0420 | Tank 12 Duration | | | |
| PMS1010 | 1st 9 Month Progress Milestone | 0 | 0 | 0 | 0% | | 30-Sep-24 | 0 | PMS 1020 | 1st 9 Month Progress Milestone | | | |
| W0000015 | Tank 15 Duration | 174 | 174 | 0 | 0% | 09-May-24 | 24-Jan-25 | 82 | TK15-0420 | Tank 15 Duration | | | |
| W0000011 | Tank 11 Duration | 174 | 174 | 0 | 0% | 09-May-24 | 24-Jan-25 | 82 | TK11-0420 | Tank 11 Duration | | | |
| W0000010 | Tank 10 Duration | 174 | 174 | 0 | 0% | 10-Sep-24 | 20-May-25 | 82 | TK10-0420 | Tank 10 Duration | | | |
| W0000008 | Tank 08 Duration | 174 | 174 | 0 | 0% | 10-Sep-24 | 20-May-25 | 82 | TK08-0420 | Tank 08 Duration | | | |
| PMS1020 | 2nd 9 Month Progress Milestone | 0 | 0 | 0 | 0% | | 27-Jun-25 | 268 | PMS 1030 | 2nd 9 Month Progress Milestone | | | |
| W0000009 | Tank 9 Duration | 174 | 174 | 0 | 0% | 08-Jan-25 | 15-Sep-25 | 82 | TK09-0420 | Tank 9 Duration | | | |
| W0000007 | Tank 7 Duration | 174 | 174 | 0 | 0% | 08-Jan-25 | 15-Sep-25 | 82 | TK07-0420 | Tank 7 Duration | | | |
| W0000006 | Tank 6 Duration | 174 | 174 | 0 | 0% | 05-May-25 | 13-Jan-26 | 209 | TK06-0420 | Tank 6 Duration | | | |
| W0000004 | Tank 4 Duration | 174 | 174 | 0 | 0% | 05-May-25 | 13-Jan-26 | 209 | TK04-0420 | Tank 4 Duration | | | |
| PMS1030 | 3rd 9 Month Progress Milestone | 0 | 0 | 0 | 0% | | 24-Mar-26 | 268 | PCD | 3rd 9 Month Progress Milestone | | | |
| W0000005 | Tank 5 Duration | 174 | 174 | 0 | 0% | 28-Aug-25 | 08-May-26 | 128 | TK05-0420 | Tank 5 Duration | | | |
| W0000003 | Tank 3 Duration | 174 | 174 | 0 | 0% | 28-Aug-25 | 08-May-26 | 128 | TK03-0420 | Tank 3 Duration | | | |
| W0000020 | Tank 20 Duration | 161 | 161 | 0 | 0% | 26-Dec-25 | 14-Aug-26 | 13 | TK20-0350 | Tank 20 Duration | | | |

██████████ began submitting the required preconstruction plans and administrative contract submittals in August 2023. The Post Award Kickoff (PAK) Meeting is scheduled to be held on October 4th, 2023. All planning documents will be completed and accepted to support successful achievement of milestones detailed by the project schedule.

Construction submittals will be completed and accepted with materials, supplies, and equipment being procured during this timeframe as applicable. Field pre-cleaning construction activities are anticipated to commence in mid-late September 2023, with actual tank entry activities to commence in January 2024. It is anticipated that the tanks will be drained and handed over to ██████████ by January 22, 2024. Ducting fabrication and installation will begin mid-late September and will be completed by January 22, 2024. Mobilization of equipment, additional trailer offices,

storage connexes, and ducting will need to occur prior to January 2024 to meet the December 2026 completion deadline. The [REDACTED] team realizes that scheduling is a crucial aspect in the completion of this project and will maintain a critical path schedule showing the planned and actual progress of work at the site. All on-site work will be coordinated to minimize any impact to base and facility operations.

3 Drawings and Specifications

Design work is not anticipated under this task order.

4 Methodology and Execution Strategy

This section presents the methodology and execution strategy for completing the required work, including coordination and logistics, quality control (QC), site preparation, equipment/material storage and security, mobilization/demobilization, applicable permitting, hazardous material control, etc. The services to be provided by the Government are identified.

The project activities will be coordinated with Government and subcontractors according to the Project Baseline Schedule which will be updated monthly. Refer to **6.0 Subcontractors**, for further details on the subcontractors that will be employed on this project.

Quality will be maintained by working closely with subcontractors to test and inspect their work based on the definable features of work (DFOW) listed below. Most importantly, safety will be maintained through compliance with the Accident Prevention Plan (APP) in addition to health and safety documents. The strictest requirements of the UFGS or API shall apply to cleaning activities.

DFOW:

1. Mobilization of Construction Facilities and Site Management & LOTO.
2. Tank Ventilation, Entry and Access
3. Tank Cleaning
4. Return-to-Operator Following Cleaning
5. Demobilization and Waste Handling

Project activities will be implemented in three phases: pre-construction activities, field activities, and post-construction activities. [REDACTED] will provide a finished product meeting the specific tasks listed below:

1. Disconnect tank from pipeline systems.
2. Move air until atmosphere is measured to have vapor/combustible levels safe for personnel entry.
3. Repair tower and catwalk to be safe for personnel entry per IAW EM 385-1-1.
4. Disconnect diffusers.
5. Remove inventory gauge array.
6. Remove liquid and residue.
7. Install liner access system.
8. Pressure wash all surfaces in accordance with Section 33 01 50.55 to enhance product removal while minimizing water.
9. Secure vent, nozzles, pipelines.
10. Design and install a lockable steel manway door that can be secured to prevent access for each of the 14 tanks at Red Hill.
11. (Sump Pits) Wash surfaces to enhance product removal while minimizing water.

The following subsections describe the methods used to execute the before mentioned specific tasks:

4.1 Pre-Construction Activities

The pre-construction phase will consist of a Post Award Kickoff (PAK) meeting, preconstruction planning and submittals, a preconstruction meeting, coordinating, and obtaining required applicable permits before commencing field work, and mobilization/site preparation. These activities are further discussed in the following subsections.

4.1.1 Post Award Kickoff Meeting

The PAK meeting is tentatively scheduled to be held on early October 4th, 2023 and will serve to integrate the contract personnel and all client representatives into the project team. The meeting discussions will include concerns, policies and procedures, and clear lines of communication and points of contact to be established. The meeting will also serve to establish expected schedule constraints and expected levels of communication between [REDACTED], NAVFAC HI, and facility personnel as it pertains to future operations and projects scope at Red Hill Fuels Facility which will occur during the contract timeframe.

4.1.2 Pre-Construction Meeting

A preconstruction meeting will be held as is necessary prior to performing repair or testing activities. The purpose of this meeting will be to review work steps, sequences, communication, and information with all involved parties. In addition, an objective will be to develop a mutual understanding relative to the scope, applicable permits, safety, site access, schedule and execution of the work, anticipated quality assurance/QC information/procedures, and final inspection and acceptance process prior to the performance of on-site activities.

4.1.3 Permitting, Passes, and Notification Requirements

The following items are necessary and will be/have been obtained as needed to perform the work:

- Confined Space Entry Permit(s)
- Hot Work Permit(s)
- Letter of consent from the Department of Health (DOH) for storage of material in the upper tunnel
- Air Permit for generator use from the DOH
- Letters of clarification for tank degassing (permit required vs no permit required) from the DOH

4.1.3.1 Base Work Clearance and Entry Authorizations

██████████ employees and their contractors will obtain base access through the DBIDs program. ██████████ will work with base security to obtain Red Hill Tunnel access badges. ██████████ will also work to ensure personnel are on the JTF list for the front gate at Red Hill.

4.1.3.2 Hot Work Permit

A safe for hot work certificate from a certified marine chemist will be obtained after each tank is degassed to a level suitable for hot work. ██████████ shall obtain a Hot Work Permit from the Federal Fire Department whenever doing hot work, in addition to the marine chemist certification.

4.1.3.3 Confined Space Entry Permit

A confined space entry permit will be authorized by ██████████ confined space entry supervisor prior to tank entry.

4.1.4 Mobilization and Site Preparation General Activities

██████████ will conduct necessary mobilization activities such that field activities may take place in a timely manner. In general, mobilization activities include moving resources such as supplies, equipment, subcontractors, and personnel to the site, establishing utilities (power, compressed air, ducting for degassing and ventilation). Completing mobilization and construction of the degassing/ventilation system in 2023 will be a critical component to ensure the project timeline can be met. ██████████ existing laydown areas will continue to be used for management and coordination of work and materials for activities at the 14 RHBFUSF and four surge tanks. See Figure 4-1 for the General Site Layout at Red Hill and location of temporary facilities, Access and Haul Routes, Site Trailers, dumpsters, sanitary facilities, parking areas, etc.

██████████ also has a laydown area just East of ADIT 1 which will be utilized for cleaning of the four surge tanks.

The existing and proposed general site layout for Red Hill and the Surge Tank area can be found in Figures 4-1 and 4-2, respectively.

Procurement sensitive and proprietary information – This information is exempt from disclosure under 5. U.S.C. § 552(b)(4) because it contains proprietary and procurement sensitive information.

DCRIT determination for RH – This information is exempt from disclosure under 5 U.S.C. § 552(b)(3) because it meets the requirements for exemption under 10 U.S.C. § 130e.

Figure 4-1A General Site Layout Red Hill

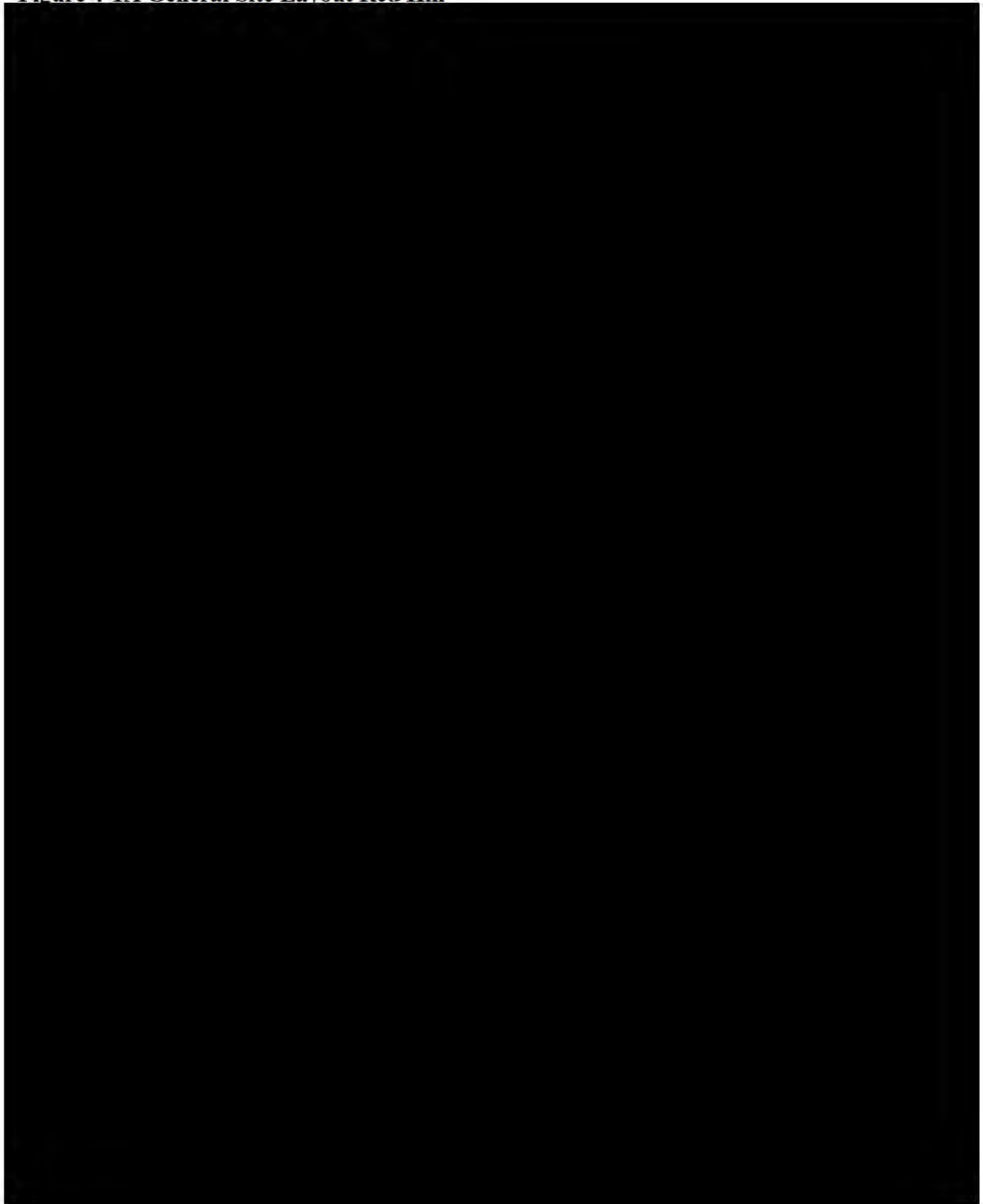

Procurement sensitive and proprietary information – This information is exempt from disclosure under 5. U.S.C. § 552(b)(4) because it contains proprietary and procurement sensitive information.

DCRIT determination for RH – This information is exempt from disclosure under 5 U.S.C. § 552(b)(3) because it meets the requirements for exemption under 10 U.S.C. § 130e.

Figure 4-2 General Site Layout Surge Tanks

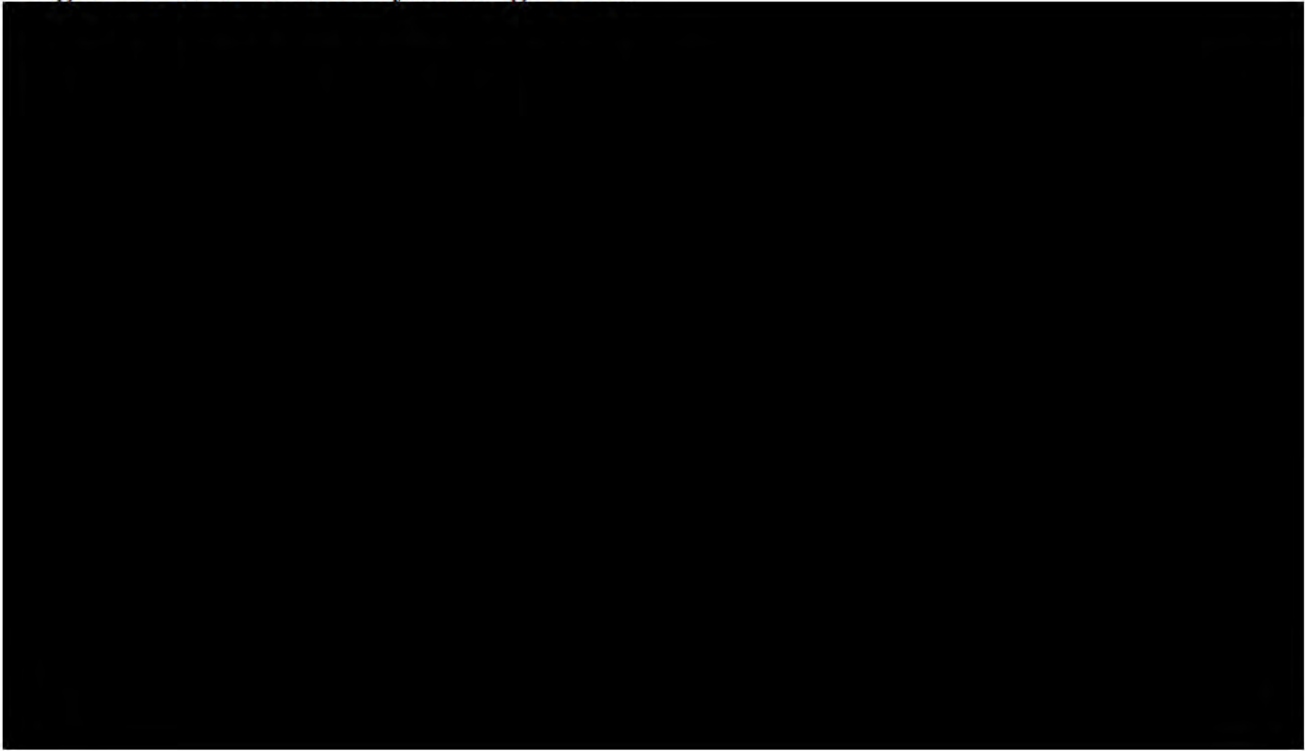

4.2 Field Activities

Field work for this TO will be performed for each tank in the following general sequence:

1. Mobilization & Site Setup: includes installation of temporary utilities such as power, compressed air, degassing/ventilation system, and installation of davit system for 8-foot manway removal. Actions include, but are not limited to, the following:
 - a) Bringing in additional office trailers, storage connexes, and trailers for hygiene.
 - b) Core holes through ADIT 4 and select bulkheads to facilitate ducting installation.
 - c) Fabricating and installation of the ducting for degassing/ventilation in the upper tunnel.
 - d) Placing concrete pads for parking for additional personnel.
 - e) Placing concrete pads and installation of degassing/ventilation fan at ADIT 4.
 - f) Staging additional generator and back-up compressor at ADIT 4.
 - g) Personnel and equipment will be moved to/from the tunnels via golf carts, taylor dunn carts, and electric bikes (if approved). [REDACTED]'s train will be utilized to move material throughout the tunnel system.

- h) Staging and assembling booms, cables, airlines, hydraulic oil storage tanks for booms, mobile offices for SSHO's, power boxes, and power cables in the upper and lower tunnels.
2. Verification of Lock Out Tag Out (LOTO) locations and conditions.
3. Disconnect piping in the tank gallery and install fans and ducting for degassing/ventilation.
4. Open tank 32-inch manways for degassing and 8-foot diameter hatch after degassing to evaluate interior atmosphere, replace with temporary lockable entry during the active work phase.
5. Pump in water to float out residual fuel in the tank.
6. Initial Tank Setup: Install lifelines on catwalk and initial tank lighting, install spider buggy for center tower.
7. Structural inspection and condition assessment of catwalk and center tower.
8. Install tank lighting system and perform catwalk and tower repairs.
9. Removal of sludge.
10. Installation of booms with suspended scaffolds.
11. Perform tank cleaning and obtain safe for hot work certificate from the certified marine chemist.
12. Final government inspections and completion of certification report and other required closeout documentation.
13. Removal of booms and suspended scaffolds.
14. Close tank with the new lockable steel door which will not be airtight.

Tasks identified in the following sections describe in general terms the methods to be used to complete the field work in support of this TO.

4.2.1 Tank Access

The unique design of each of the Red Hill underground storage tanks represents a special design challenge to provide safe access to all areas of the tank interior. All work associated with tank access and ventilation will be performed by [REDACTED]. Applicable guidance that will be followed for this work will include API Standard 2015: Requirements for Safe Entry and Cleaning of Petroleum Storage Tanks, and API Recommended Practice 2016: Guidelines and Procedures for Entering and Cleaning Petroleum Storage Tanks. A central structural tower is located at the center of each tank. There is also a catwalk from the 8-foot diameter hatch at the spring line that extends horizontally to the central structural tower.

The surge tanks will be accessed via a manway on the side of the tank. These tanks will not require a critical lift plan and can be cleaned from the tank bottom.

4.2.1.1 Central Tower & Catwalk Inspection

████████████████████ will conduct a structural inspection of the catwalk and central structural tower to certify them safe to use by workers for the RHBFUSF. ██████ will be inspecting, per tank:

- Center Tower Frame (1)
- Spider Hoist Assembly (1)
- Catwalk Bridge (1) & Working Platform(s)
- Boom with Suspended Scaffold System (2)

A Spider Staging ST-17 air driven Industrial Basket or equivalent will be load tested and then used to lower the inspector down the center structural tower. The designs and details for the anchorage for the Spider basket system and the fall arrest safety lines are the same as has been utilized by ██████ in Tanks 5, 13, 14, 17 and 18.

After ██████ completes their inspection ██████ will review the inspection report and evaluate their recommendations and make repairs as required per the SOW.

Inspection is not expected for the surge tanks since these tanks are only 20 foot tall and can be cleaned from the floor of the tank.

4.2.1.2 Access Equipment

For the purposes of interior access and the awarded SOW, the steel shell is comprised of three general areas. Each of these areas have unique challenges as it pertains to access. ██████ plans to utilize similar means of access as has been used in other Tanks at Red Hill.

Lower Dome

The bottom hemispherical shape from the shell bottom cylinder transition joint to bottom of tank is called the Lower Dome. The lower 45-degree arc surface can be accessed with the use of flexible ladders and/or the boom and suspended scaffolds. All workers will have safety harnesses connected to independent lifelines via cable grabs connected to compliant anchors.

Barrel & Extension Ring

The vertical shell cylinder is called the Barrel. Tank 1 has a transition plate at the top of barrel that is called the Extension Ring. It is expected that tanks of similar vintage (Tanks 2, 3, & 4) will have construction similar to Tank 1. ██████ plans to traverse areas of the barrel and Extension Ring via boom and suspended scaffold baskets.

Upper Dome

The hemispherical dome section between the top of the Extension Ring and the top of the tank is called the Upper Dome. All areas up of the upper dome, up to course “D”, will be accessible via boom and suspended scaffold baskets.

No specialty access equipment is required for the surge tanks. The surge tanks mirror traditional cut & cover tanks.

4.2.2 Provision of Utilities

Efficient temporary power and compressed air will be supplied at each tank as needed by adding onto [REDACTED] existing utility infrastructure, as necessary. The existing infrastructure was innovatively designed in a modular fashion which allows for the addition of the same types of power panels/cables/generators and compressors to supply utilities to additional tanks being cleaned in parallel. Power panels and ventilation systems have been and will be custom engineered and sized to fit in the RH tunnels with access constrained by tunnel dimensions and multiple bulkheads/blast doors. The power generation and compressed air systems have been installed in a small secondary contained area outside Adit 6 and are operated by environmentally compliant tier IV diesel engines. This system has operated reliably for the last five years and at times 24/7 to support complex coating and welding operations in up to three (3) RH tanks simultaneously. The system is scalable and can be expanded to supply utilities to more tanks to be run in parallel. A description of individual utilities follows.

Power: **Figure 4-3** depicts how power will be supplied to each tank. [REDACTED] proposes cabling and distribution panelboards enough to add to this existing setup to the extent necessary to supply power to 4 – 6 separate tank work locations concurrently. This would allow for the maximum amount of redundancy and schedule flexibility. This system should provide sufficient power for cleaning activities as equipment and tools used for cleaning are lower amperage than coating and welding-type activities performed using this system in the past.

A separate generator and fuel tank, same model, as the existing ones, will be provided for the 200 HP fan required to de-gas/ventilate the tanks from ADIT 4. The fan will be powered by it’s own, separate generator. This configuration has not been shown due to the simplicity of the system.

Figure 4-3 Power

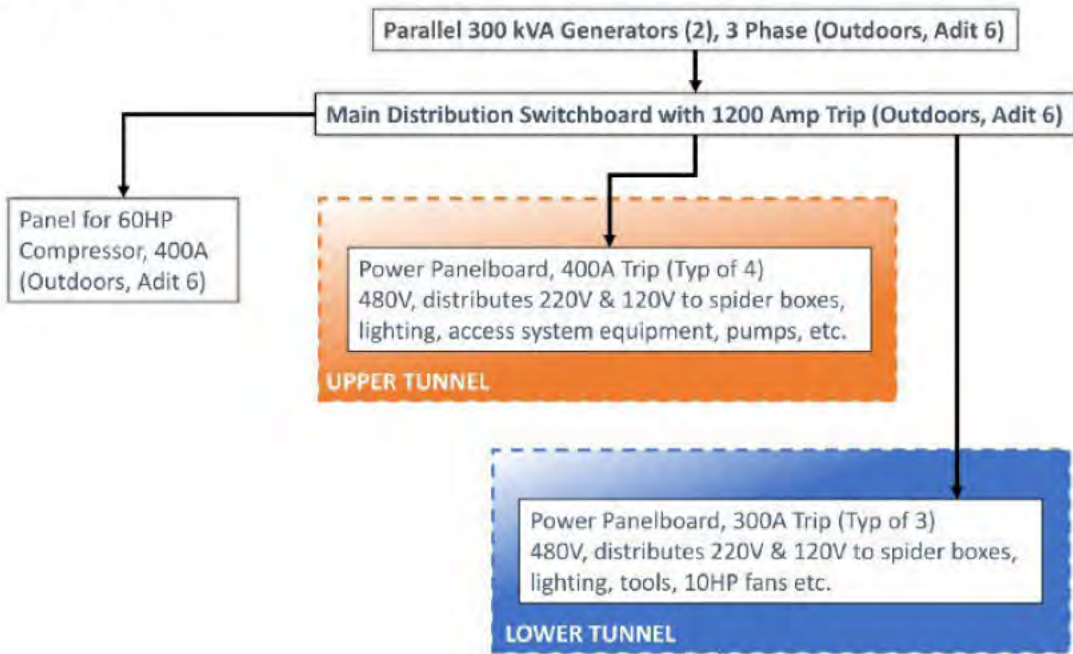

4.2.3 Repair Design

If design is required for any repairs after tower inspection, [REDACTED] will act as the project Designer of Record (DOR) per Section 3.0 of this plan and as required per the project SOW. Repairs will be signed and sealed by a professional engineer.

4.2.4 Tank De-Gassing, Access Setup and Cleaning

Tank cleaning will be performed as necessary to meet project specifications and the project SOW as outlined below.

4.2.4.1 RHBFUSF TANKS

Tank De-gassing: For each tank, the 30” manway on the 8’ access hatch, a blind flange on a tank nozzle in the lower tunnel alcove and the top of tank manway will be opened by personnel in appropriate PPE to determine Volatile Organic Compound (VOC) levels. [REDACTED] has developed specific safety checklists, procedures, and controls to eliminate unnecessary risks when first opening tank nozzles, manways, and hatches. Degassing operations will be completed via the 30” manway prior to 8’ hatch removal. After degassing operations have lowered VOCs to safe levels, personnel with proper PPE (full-face/half-face respirators with organic vapor cartridges) will enter the tank through the manway and via the top of the tank by way of a center tower suspension beam which serves as an anchor for suspended scaffold loads up to 1,410 lbs. Since the ventilation system will maintain a negative pressure in the tank, VOCs from the interior will not be able to escape into any part of the facility. After removal, the 8’ hatch will be secured close to the egress/ingress opening. VOC’s and LEL’s will be tested prior to removal of the 8’ hatch. A temporary access ramp and lockable steel manway door will be installed for safe and secure access to the tank.

A degassing/vent line that is approximately 50-inches in diameter will be installed throughout the upper tunnel. A 200 HP fan will be staged outside rated to exhaust 90,000 CFM during degas operations, See **Figure 4-4**. The piping in the lower tunnel will be disconnected in each alcove and a fan hooked up to blow air into each tank. Initial degassing of the tank will be via the 30-inch hatched access on the 8-foot manway and then potentially through the 24-inch vent line that is encased in gunnite.

To ensure the safety of the personnel entering the tank and involved in the tank cleaning, repairs, and inspections, the safe for hot work certificate will be maintained by competent person certifying gas free status and ventilation are being maintained adequately. A safe for hot work certificate covers worker entry authorization.

Figure 4-4 Ventilation Schematic.

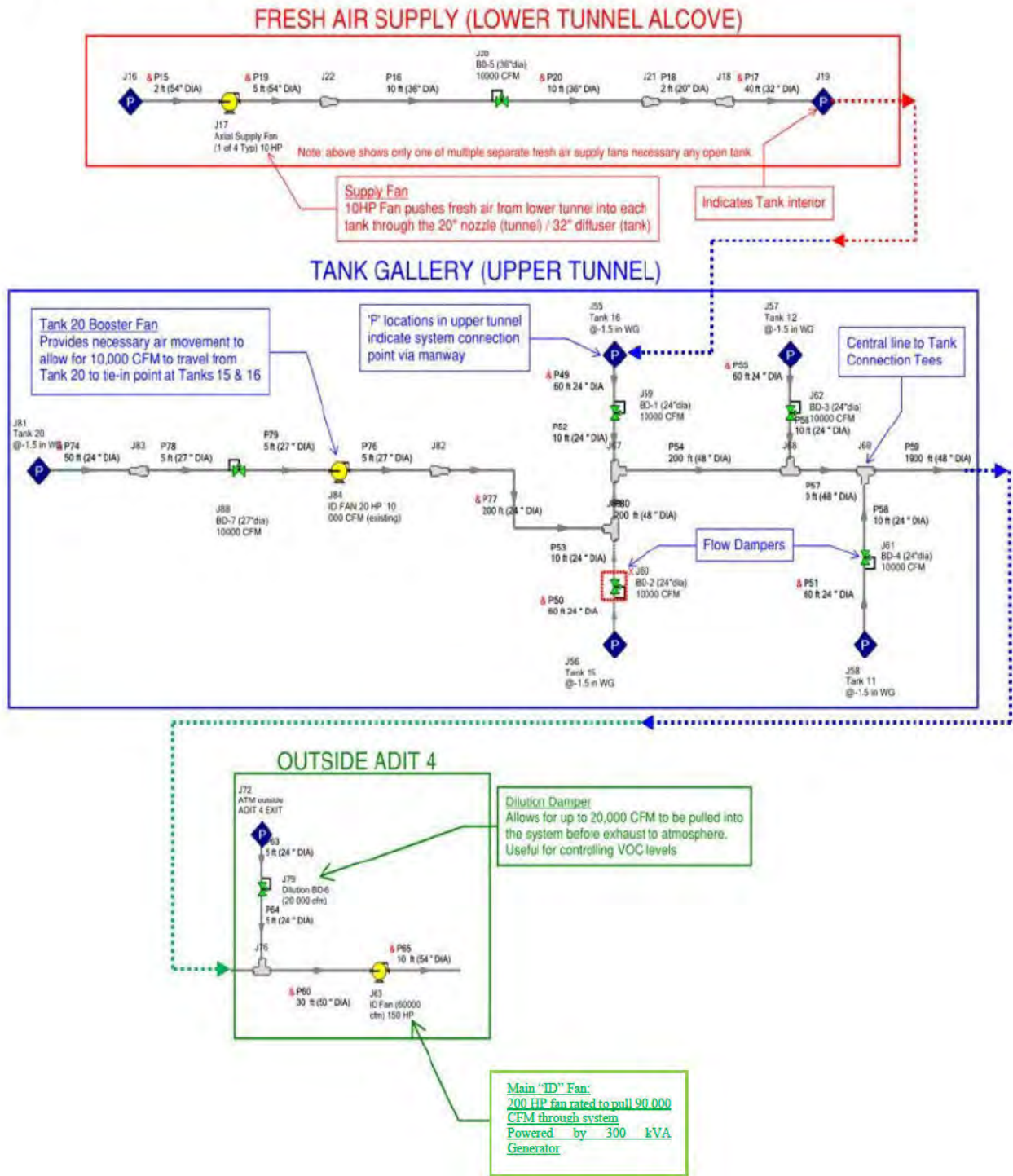

Access System Installation: See **Figure 4-5** for an overview of suspended scaffold systems used to access the shell and bottom of the tanks.

To prepare tank for installation of access systems, [REDACTED] will perform the following tasks in similar fashion to the work they have executed in RH Tanks 1, 5, 13, 14, 17, and 18 for [REDACTED] personnel selected to act as field foreman for access system installation crews have experience doing the same type of work in multiple RH tanks. Lifelines will be installed at catwalk and center tower, center tower basket will be installed, lighting systems will be put in place, the 32” diffuser will be disconnected and left at tank bottom, and support will be provided to structural engineer for inspection.

Before the booms and suspended scaffold can be installed, a structural engineer from [REDACTED] will inspect existing tank catwalk and center tower infrastructure for deficiencies. [REDACTED] has completed structural inspections and reports on at least 5 other RH tanks which commonly require replacing missing or damaged fasteners and diagonal braces on the tower.

After the tower and catwalk have been certified by [REDACTED] as being structurally sound for the scaffold boom installation, these booms will be installed. These systems were custom designed by [REDACTED] Structure group to provide safe access to most of the interior tank shell. Several proprietary innovations to systems used by previous contractors have allowed a greater range of access (approximately 10° extra rotation around tower) and additional capacity (approximately 300 more pounds per scaffold boom) to facilitate construction. The systems will be load tested in compliance with previously accepted procedures by the Government. Load testing will be witnessed and certified by [REDACTED] [REDACTED] who has done the same for Tanks 1, 5, 13, 14, 17, and 18. Each scaffold boom has been load tested to 1,660 pounds and is expected to be load tested to the same capacity for each tank; each of the hoists will be load tested to 1,500 pounds and each suspended scaffold will be load tested to 1,500 pound capacity. The hoist/suspended scaffold operates independently of the boom system in vertical ascent/descent. Each scaffold boom can be rotated 190° on the “left” and “right” sides with overlap on both ends of travel. Each scaffold boom can be raised from 0 to 85° vertically. There is a jib tip which is able to extend 10 feet from the end of the fixed scaffold boom. This system can access all parts of the shell interior up to top of Upper Dome D which allows for full cleaning of interior tank surfaces at close range with 5,000 psi sprayers. The system will be maintained, tested, and operated in accordance with the access system plan that has successfully guided [REDACTED]’s previous RH tank projects. All suspended scaffolds will have insulated vertical lifelines installed and 100% fall protection tie-off will be strictly enforced.

A 20 cubic foot air receiver vessel similar to those operated by [REDACTED] during previous tank repair contracts will be installed at each of the tanks. This vessel allows smooth operation of the air motors for the booms and air tools/equipment needed to support all inspections and repairs.

Figure 4-5 Shell Access System. [REDACTED] will use a suspended scaffold system to access the shell/bottom of the tank.

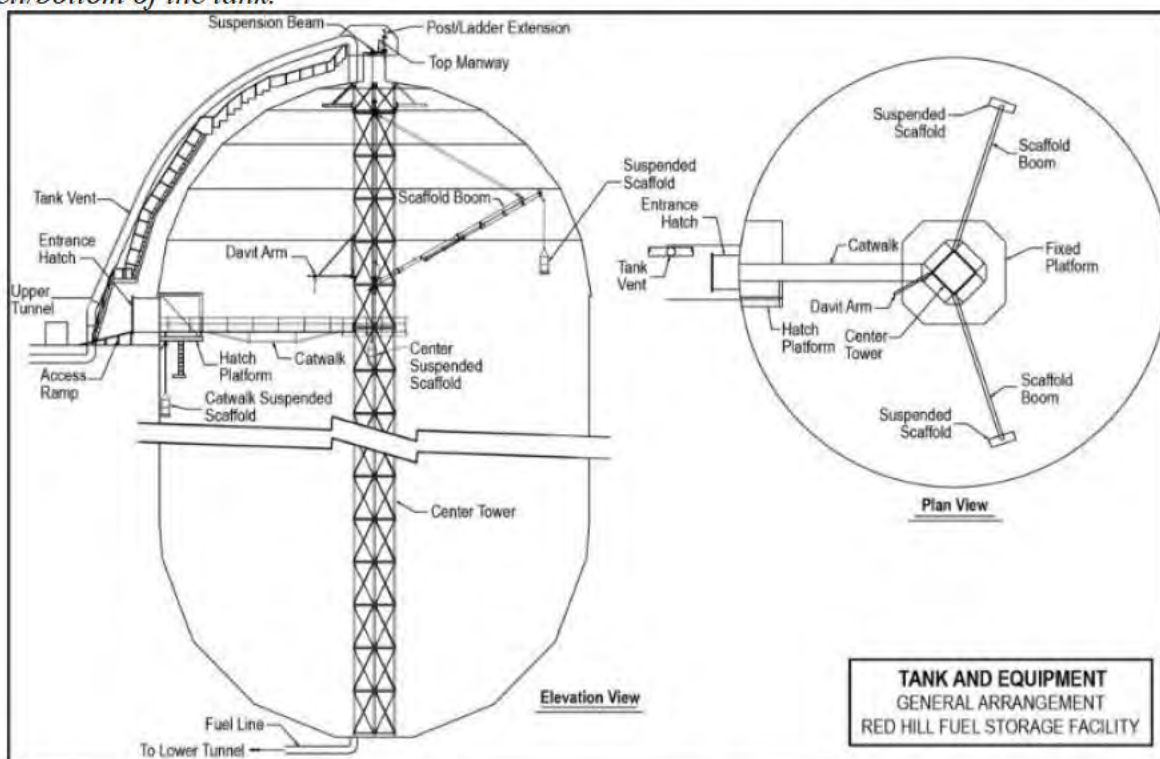

Cleaning: [REDACTED] will clean the tanks and provide turnkey handling and disposal of waste and rinsate water. [REDACTED] will use the center man-basket to initially access the tank floor. Cleaning will be performed by power washing of all internal structures from the suspended scaffolding, as appropriate. The top of tank, center tower, walls and lower dome floor will be pressure washed clean, with water mixed with simple green using electric pressure washer with a capacity of up to 5,000 PSI until all areas are clean, similar to tank cleaning [REDACTED] performed on Red Hill Tank 13 and Tank 18. The catwalk will be washed starting from the floor area and working up to the railing, Spraying in a horizontal, side-to-side technique. For the center tower, washing will start from the top down outside and inside. Spraying in a horizontal, side-to-side manner. Each scaffold boom can be raised from 0 to 85° vertically, to reach approximately 40' above the extension ring up to the D course. There is a jib tip which is able to extend 10 feet from the end of the fixed scaffold boom. This system can access the shell interior up to the top of Upper Dome Course D. The system will be maintained, tested, and operated in accordance with the scaffold boom access system plan that has successfully guided [REDACTED] previous RH tank projects.

Water pressure in the legacy fire water line in the upper access tunnel is equipped with sufficient pressure as found by previous tank cleaning contracts. Simple green (See Appendix C for SDS) will be siphon fed directly through the water gun hose. Simple green will be siphoned out of a five-gallon pail. [REDACTED]'s employees performing cleaning tasks will have received HAZCOM training and have previous handling experience. Simple green will be stored in 55-gallon drums. All storage will occur on spill pallets/within secondary containment. Storage locations will vary based on schedule and need. A usable amount of simple green will be stored on site. Transfers of simple green will occur within secondary containment.

After the area has been pressure washed utilizing simple green, a follow-on freshwater rinse will be conducted. The nozzle on the pressure washer has a feature that will block the mixing of simple green, allowing for freshwater only. Pressure washing will be performed at an approximate distance of 2 to 4 feet, with up to two passes for each area and up to 2 to 3 feet of overlap.

[REDACTED] will dispose of up to 3,000 gallons of residual fuel and debris/sludge (per tank) that will be removed from the tank bottom. Removal of debris/sludge and dry cleanup (rags, absorbents) will be performed as needed to obtain safe for limited hot work Certified Marine Chemist (CMC) certificate. Sludge will be removed with shovels, placed into drums, and taken out of the tank via the center tower basket. Drums of sludge will be stored in an adjacent alcove within a secondary containment. Drum dollies will be used to transport the drums of sludge out of the tank. [REDACTED] will load the drums onto a flat-bed truck for disposal. No waste is assumed to be hazardous per PPI #4.

Each Red Hill tank is assumed to require no more than 36,000 gallons of water and an approved cleaning solution. These quantities are conservative estimates based on wastewater handled for previous tank cleaning projects at RH. The FOR line in the tank gallery will be used to transport rinsate from each RHBFUSF tank to Tank 311, where [REDACTED] will collect the rinsate and dispose of it off-site IAW all Federal, State, and Local regulations.

To assist in the safe and efficient disposal of rinsate water, [REDACTED] assumes full control of the Fuel Oil Recovery (FOR) line which spans the lower tunnel, connecting tank drain lines to tank 311 which is located outside of Adit 3. [REDACTED] will complete cleaning of tank 311 prior to use to ensure the tank is clean and in good working order for use as a rinsate holding tank. [REDACTED] will visit Tank 311 frequently, using vacuum trucks to remove rinsate which has been tested and characterized. The fluid level of Tank 311 will be monitored via a level gauge to ensure that the tank is not overfilled in accordance with UFC criteria. Vacuum trucks will be scheduled, as required, to remove rinsate from Tank 311.

As tank power washing is initiated, [REDACTED] quality control processes will be applied to ensure that all areas of the tank shell and appurtenances are thoroughly cleaned. The tank(s) will be visited daily by the QCM and visual spot checks performed. Areas found to not be visually clean

shall be rewashed in accordance with the standard cleaning process. 100% of the interior tank surface will be visually inspected. Tank cleaning progress will be documented in the daily QC report and via a laminated shell rollout located outside of the tank. [REDACTED] will prepare daily mapping and photo-documentation of the approximate square footage completed using a generic shell layout map (See an example in Appendix A for Tank 17), with daily updates of cleaned areas. Each area of the shell/dome that is cleaned will be marked out by our subcontractor at the end of each cleaning session with magnets/ribbons, tape, chalk, paint, or other means to keep close track of the completed and cleaned surfaces. After pressure washing has been completed, the tank will be dried utilizing forced air from the fans connected in the tank gallery.

This project was awarded on the basis that "Clean" is defined as: "The removal of all product, vapor, sludge, and residue from a tank, and washing, rinsing, and drying a tank so that no product or residue remains on any tank surfaces (shell, bottom, piping, appurtenances, etc.). Only a visual inspection will be required for a tank to be constituted as "Clean".

4.2.4.2 Surge Tanks

For each surge tank the manway on the side of the tank will be opened by personnel in appropriate PPE to determine Volatile Organic Compound (VOC) levels. [REDACTED] has developed specific safety checklists, procedures, and controls to eliminate unnecessary risks when first opening tank nozzles, manways, and hatches. Degassing of the tank will occur by installing a fan with flexible ducting, or similar, through the manway on the side of the tank. The air will then be pushed/pulled out of the normal vent on top of each tank. An additional fan may be installed and attached to the normal vent on top of each tank to facilitate air removal. The valve on the fill/issue line may also be removed and a fan installed to expedite degassing of the tank. It is not expected for there to be excessive fuel/sludge present in these tanks, up to 500 gallons per tank.

Cleaning: Cleaning will be performed by power washing of all internal structures. The entirety of the interior of the tank will be pressure washed clean, with water mixed with simple green using electric pressure washer with a capacity of up to 5,000 PSI until all areas are clean. The tanks will be visited daily, and visual spot checks performed. Areas found to not be visually clean shall be rewashed in accordance with the standard cleaning process. After the area has been cleaned, it will receive a freshwater rinse. The nozzle on the pressure washer has a feature that will block the mixing of simple green, allowing for freshwater only. Pressure washing will be performed at an approximate distance of 2 to 4 feet, with up to two passes for each area with up to 2 to 3 feet overlap. An extra-long pressure washing wand will be used to reach all areas within the tank. Water usage for each surge tank is anticipated to be approximately 5,000 gallons. Adequate access (ladders, scaffolding, etc.) will be provided to facilitate QC inspections along with the final government inspection to ensure all tank surfaces areas are clean. All tank cleaning will be conducted from the bottom of the tank, and a vacuum truck/diaphragm pump will be used to

remove fuel/sludge/rinsate directly out of the tank. After pressure washing has been completed, the tank will be dried via forced air provided by the ventilation fan. Refer to **Figure 4-6** for a simple line diagram of the previously discussed components for the Surge Tank.

Figure 4-6 Surge Tank Line Diagram.

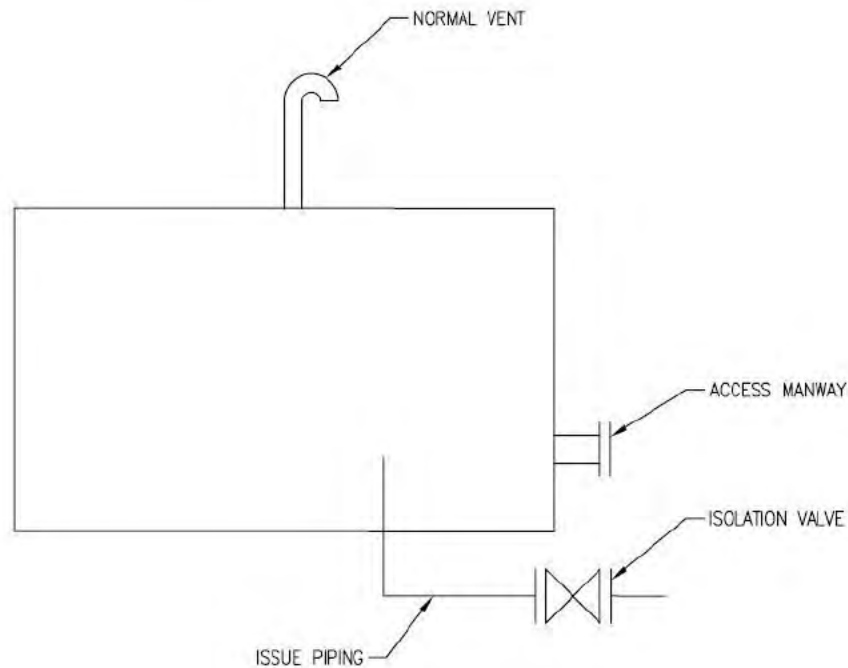

4.2.4.3 Sump Pits

The main sump and sump 7 will be cleaned utilizing power washers and simple green similar to the tanks, followed by a freshwater rinse. They will be washed from the top down, spraying in a horizontal, side-to-side technique. The sumps will be visited daily, and visual spot checks performed. Areas found to not be visually clean shall be rewashed in accordance with the standard cleaning process. Rinsate will be pumped back into the FOR line. These areas are not considered confined spaces and do not require fall protection.

4.2.5 Work Completion Walk Through

Upon completion of the required cleaning tasks for each tank, a work completion walk through will be conducted as requested. The [REDACTED], base representative(s), FEAD representatives, and the NAVFAC HI NTR, or designee, will conduct the final acceptance inspection. The purpose of this inspection will be to ensure that all the Government's requirements and expectations have been successfully completed and the Government will accept all work performed by the [REDACTED] team.

4.3 Post-Construction Project Activities

Post-construction activities may include demobilizing, managing any waste, and preparing a project certification report as described in the project specifications and SOW. *Demobilization, Waste Handling, and Work Completion*

Upon completion of the project, [REDACTED] will return all facilities and storage areas to the condition they were in prior to being occupied. Demobilization will include the removal of heavy equipment, materials, supplies, and rentals, the disposition of government property, and the removal, transportation, and disposal of waste. All demolished material, rubbish, and debris generated by the project will be appropriately containerized and disposed of at an approved off-site location. All contractor equipment, rentals, and miscellaneous material will be removed in a timely, efficient, and cost-effective manner. No environmental waste will leave the site without prior authorization of the NTR. [REDACTED] will take preventative measures to protect the environment from any negative effects of the work being performed. Hazardous material handling will be performed in accordance with the manufacturer's specifications and will conform to all applicable federal, state, and local regulations. [REDACTED] will provide waste disposal documentation for each tank. A final sign-off sheet will be provided for each tank once the work is complete. The sign-off sheet will be provided to the government for signature and acceptance.

Several best managements found from previous experience are as follows:

1. Always expect fuel in pipelines when cracking flanges. Use appropriate containment to capture any residual product that may come out.
2. Always double check LOTO.
3. No dry sweeping in the tunnels. Dust will kick-up and float down the entire tunnel.
4. Only use 4-wheel dollies for transporting drums due to uneven surfaces.

5 Key Project Personnel

Table 5-1 displays a list of key project personnel and project stakeholders.

Table 5-1 Key Project Personnel

| Organization | Title | Name | Phone Number/E-Mail |
|--------------------------|--------------------------------------------|------------|---------------------|
| NAVFAC HI FEAD | Administrative Contracting Officer | | |
| | Contracting Officer's Representative | | |
| | Engineering Technician | | |
| NAVSUP FLC-PH | Fuel Director | | |
| | Deputy Fuel Director | | |
| | Supervisory General Engineer | | |
| | Operations Supervisor | | |
| | Bulk Fuels Supervisor | | |
| DLA Installation Support | Project Engineer | | |
| [Redacted] | Program Manager | [Redacted] | [Redacted] |
| | Contract Administrator | [Redacted] | [Redacted] |
| | Sr. HSE Manager | [Redacted] | [Redacted] |
| | Program Engineering Manager | [Redacted] | [Redacted] |
| [Redacted] | Project Manager | [Redacted] | [Redacted] |
| | Construction Manager (Site Superintendant) | [Redacted] | [Redacted] |
| | Construction Manager (Site Superintendant) | [Redacted] | [Redacted] |
| | Quality Control Manager (QCM) | [Redacted] | [Redacted] |
| | Site Safety and Health Officer (SSHO) | [Redacted] | [Redacted] |

5.1 Project Team Responsibilities

5.1.1 Project Manager

[Redacted] s Project Manager, [Redacted], will be NAVFAC HI's primary point-of-contact and responsible for maintaining the overall project scope, schedule, and budget for this TO. He is also responsible for status reporting, financial tracking, scheduling, and compliance with TO contract requirements, overall, TO quality, and all project correspondence and documentation. [Redacted]

[Redacted] will work closely with his team and subcontractors to ensure an understanding of all

construction schedules, constraints, and the Navy’s overall goals and objectives, and will be responsible for the preparation of monthly status reports.

5.1.2 Construction Manager (Site Superintendent)

██████████ Construction Manager’s (CM), ██████████, will be the lead persons responsible for execution of all field activities, coordination of subcontractor’s activities, preparation of daily production reports, coordinating on-site logistics and access, ensuring schedule and budget adherence.

5.1.3 Quality Control Manager

██████████’s Quality Control Manager, ██████████, will be responsible for conducting the preparatory and initial QC meetings and ensuring all appropriate QC meetings are held and documented. The QC Manager will prepare the daily quality control reports, maintain the nonconformance log for the project, and validate any items that must be corrected. She will collect and validate all subcontractor quality control reporting requirements. The QC Manager will have the requisite authority, including stop-work authority, to ensure that all project site activities comply with applicable specifications of the approved project documents and the contract. She will ensure that all materials and sitework meets or exceeds QC acceptance criteria.

5.1.4 Site Safety and Health Officer

██████████ Lead Safety Officer, ██████████, along with an anticipated five additional SSHO’s, will have the requisite authority to administer the Site Safety and Health Plan. This authority applies equally to all project activities, whether performed by ██████████ or its subcontractors. The Safety Officers will implement and enforce the project safety policies and procedures and will conduct daily safety meetings and site safety inspections.

6 Subcontractors

Table 6-1 gives a list of the main subcontractors selected to perform work on this project.

Table 6--1 Subcontractors

| Company | Role | Point of Contact Name | Phone Number/E-Mail |
|------------|----------------------------------------------------------|-----------------------|---------------------|
| [REDACTED] | Mechanical LO/TO, Repairs, General Labor, Boom operators | [REDACTED] | [REDACTED] |
| [REDACTED] | Tank Cleaning | [REDACTED] | [REDACTED] |
| [REDACTED] | Structural Inspections and Certifications | [REDACTED] | [REDACTED] |
| [REDACTED] | Lead Planner, Competent Person | [REDACTED] | [REDACTED] |
| [REDACTED] | Electrical systems | [REDACTED] | [REDACTED] |

6.1.1 Designer of Record

Design is not applicable to this task order.

6.1.2 Mechanical and Piping Subcontractor

[REDACTED] will provide all on-site labor, equipment, and material to complete the mechanical and structural repairs to the tank, along with providing general labor.

6.1.3 Tank Cleaning/Waste Rinsate Disposal

[REDACTED] will be responsible for tank cleaning services prior to tank repair activities. They will also be responsible for removing and disposing of rinseate water, sludge, and residual fuel.

6.1.4 Structural Engineering

[REDACTED] will inspect, evaluate, and suggest repairs for the catwalk and center towers. Installation of the manway davit and boom supports may also be designed and evaluated by [REDACTED].

6.1.5 Lead/asbestos Competent Person

[REDACTED] will also provide testing services to ensure the wrap on the vent line encased in gunnite does not contain asbestos. The presence of lead or asbestos is not anticipated on this project, however if encountered [REDACTED] will provide lead abatement services and third-party consultants as needed to sample air for lead until a Negative Exposure Assessment report can be generated, as, applicable.

Appendix A

Generic Shell Layout Map (Tank 17)

Procurement sensitive and proprietary information – This information is exempt from disclosure under 5. U.S.C. § 552(b)(4) because it contains proprietary and procurement sensitive information.
PII – This information is exempt from disclosure under 5 U.S.C. § 552(b)(6), which protects personally identifiable information.

D

C

B

A

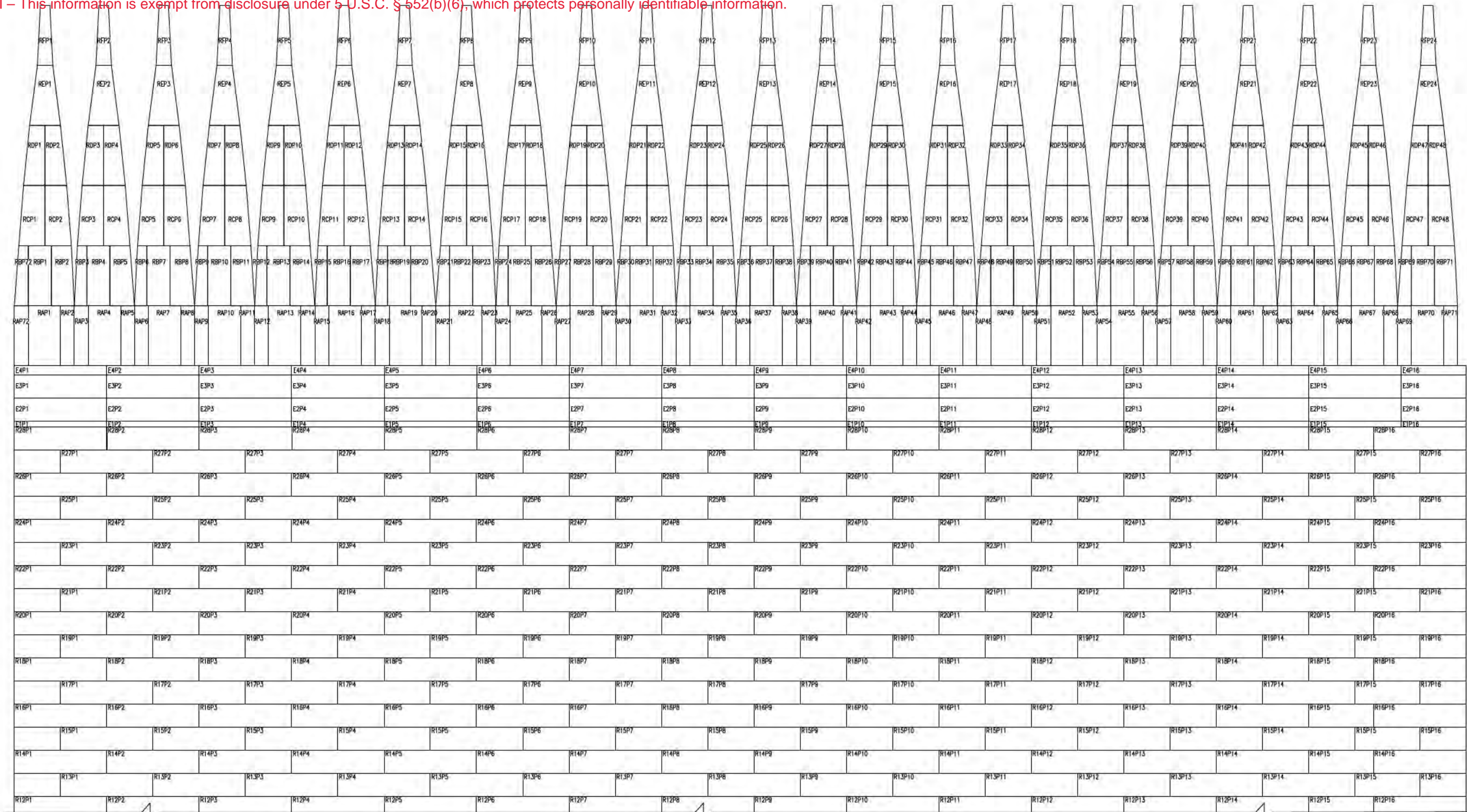

SEE MATCH-LINE G-101

TOP of TANK – SHELL ROLL-OUT

TANK 17 PLATE LAYOUT

SCALE: N.T.S.

100 % DESIGN FOR REVIEW

IF SHEET IS LESS THAN (22" x 34")
IT IS A REDUCED PRINT-SCALE. REDUCE ACCORDINGLY.
PRINT DRAWINGS IN PDF FORMAT ON 11x17 PAPER.
THE CONTRACTOR SHALL BE RESPONSIBLE FOR COORDINATING THE WORK
AMONG THE VARIOUS TRADES AS NECESSARY TO AVOID CONFLICTS AND TO
ENSURE THE INSTALLATION OF ALL WORK WITHIN THE AVAILABLE SPACE.

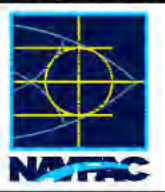

DEPARTMENT OF THE NAVY
NAVFAC ENGINEERING COMMAND
PORT HUENEME, CA
PEARL HARBOR, HI
CLEAN, INSPECT AND REPAIR
RED HILL TANK 17

| REV | DESCRIPTION | DATE | APP | CHK |
|-----|------------------------|------------|-----|-----|
| A | 100% DESIGN FOR REVIEW | 08/29/2019 | | |

G-100

QUANTITY: 1000

Procurement sensitive and proprietary information – This information is exempt from disclosure under 5. U.S.C. § 552(b)(4) because it contains proprietary and procurement sensitive information.
 PII – This information is exempt from disclosure under 5 U.S.C. § 552(b)(6), which protects personally identifiable information.

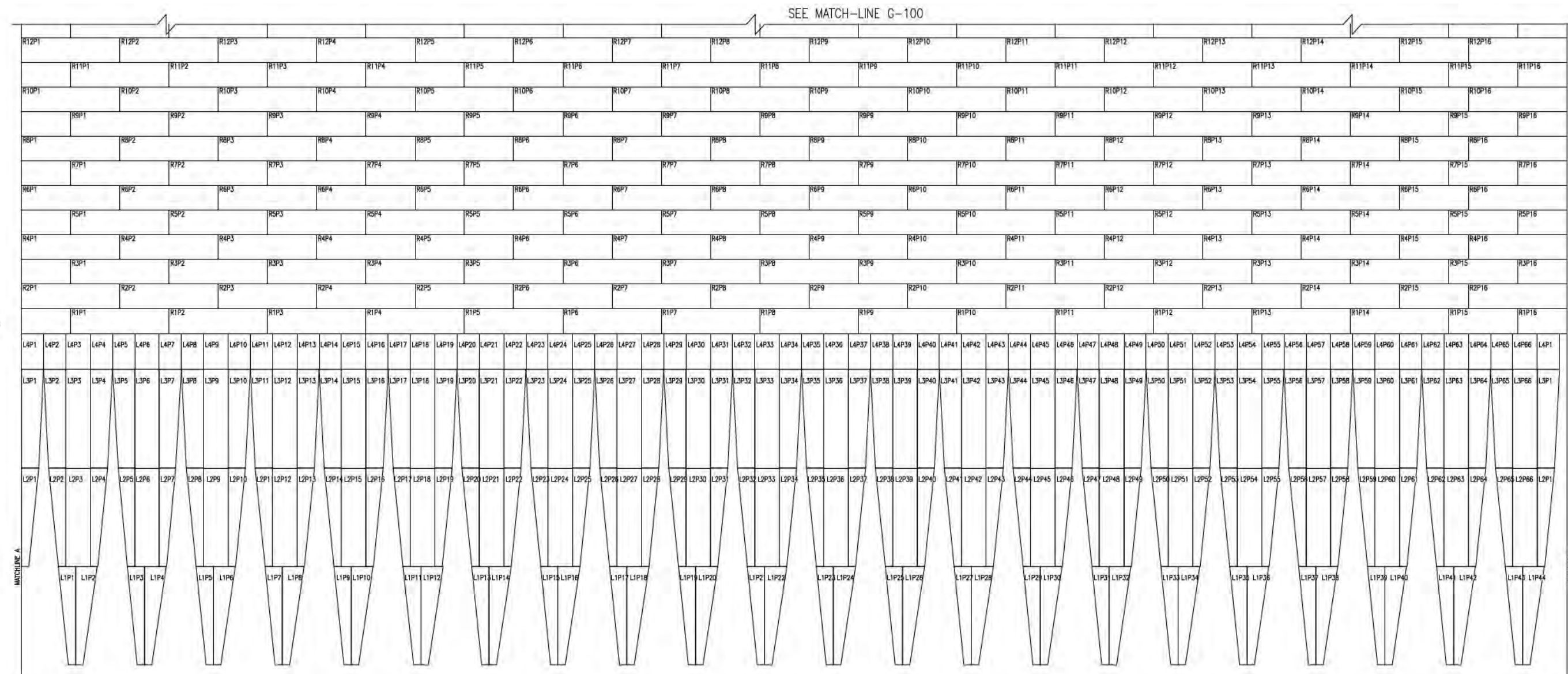

BOTTOM of TANK – SHELL ROLL-OUT

TANK 17 PLATE LAYOUT

SCALE: N.T.S.

100 % DESIGN FOR REVIEW

IF SHEET IS LESS THAN (22" x 34")
 IT IS A REDUCED PRINT-SCALE. REDUCE ACCORDINGLY.
 PRINT DRAWINGS IN PDF FORMAT ON 11x17 PAPER.
 THE CONTRACTOR SHALL BE RESPONSIBLE FOR COORDINATING THE WORK
 AMONG THE VARIOUS TRADES AS NECESSARY TO AVOID CONFLICTS AND TO
 ENSURE THE INSTALLATION OF ALL WORK WITHIN THE AVAILABLE SPACE.

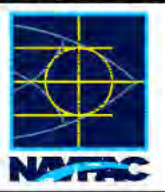
| | | | |
|----------------------------------------------------------------------------------------------------------------------------------------------------------------------------------------------------------------------------------------|--------------------------|-----|-----|
| DATE | 06/29/2019 | DJK | APP |
| DESCRIPTION | A 100% DESIGN FOR REVIEW | | |
|  | | | |
| DEPARTMENT OF THE NAVY NAVAL FACILITIES ENGINEERING COMMAND PORT HUENEME, CA JOINT BASE PEARL HARBOR-HICKAM PEARL HARBOR, HI CLEAN, INSPECT AND REPAIR RED HILL TANK 17 TANK 17 PLATE LAYOUT (2) | | | |
| G-101 <small>DATE/REVISED: 31 JANUARY 2017</small> | | | |

Procurement sensitive and proprietary information – This information is exempt from disclosure under 5. U.S.C. § 552(b)(4) because it contains proprietary and procurement sensitive information.

Appendix C

SDS and Cut Sheets

KÄRCHER

makes a difference

High pressure cleaner
Electric motor - Cold water

English.... 3

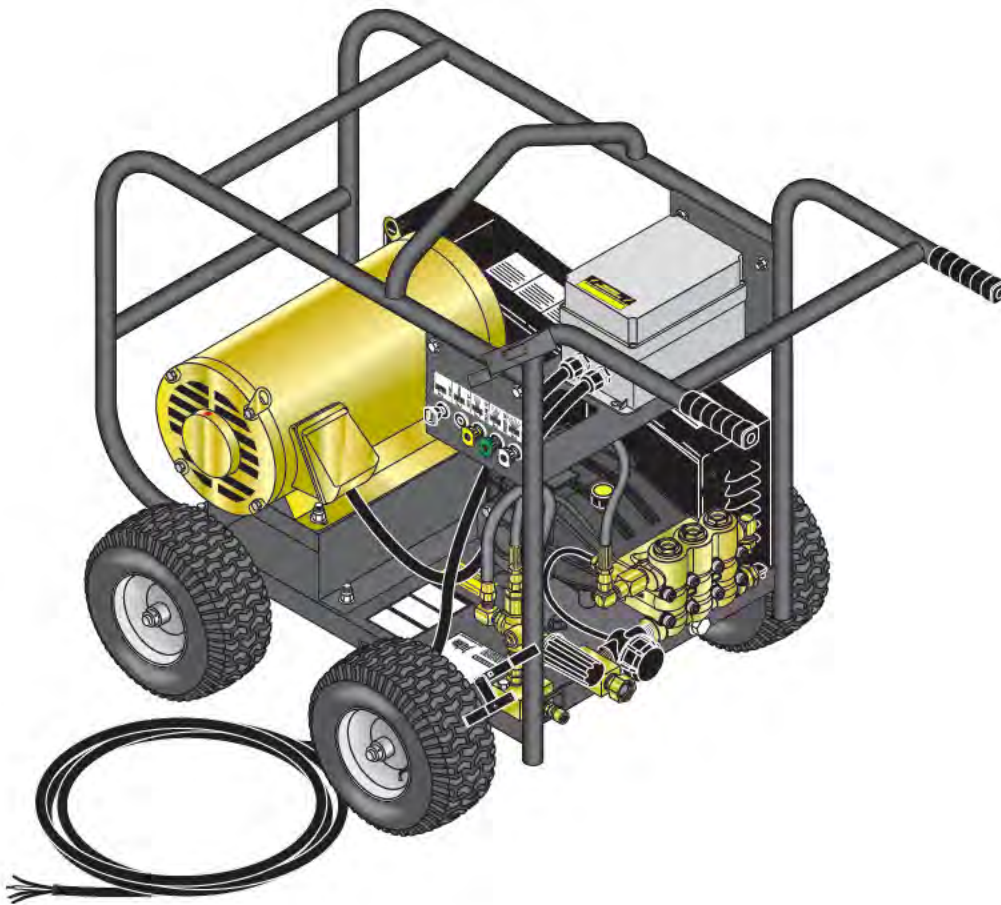

**Register
your product**

www.kaercher.com/welcome



9.800-340.0 (03/20)

MODELS:

1.107-084.0

HD 5.0/50 Eb Cage

1.107-087.0

HD 5.0/50 Eb Cage

CONTENTS

| | |
|-------------------------------------------------------|-----|
| Important Safety Information | 3-4 |
| Component Identification | 5 |
| Assembly Instructions..... | 6 |
| Operating Instructions..... | 7 |
| Applying Detergent & General Washing Techniques | 8 |
| Shutdown and Cleanup | 9 |
| Troubleshooting | 10 |
| Preventative Maintenance | 11 |
| Oil Change Record | 11 |
| Hose & Spray Gun Assembly & Parts List..... | 12 |

Model Number _____

Serial Number _____

Date of Purchase _____

The model and serial numbers will be found on a decal attached to the pressure washer. You should record both serial number and date of purchase and keep in a safe place for future reference.

INTRODUCTION & IMPORTANT SAFETY INFORMATION

Thank you for purchasing this Pressure Washer. We reserve the right to make changes at any time without incurring any obligation.

Owner/User Responsibility:

The owner and/or user must have an understanding of the manufacturer's operating instructions and warnings before using this pressure washer. Warning information should be emphasized and understood. If the operator is not fluent in English, the manufacturer's instructions and warnings shall be read to and discussed with the operator in the operator's native language by the purchaser/owner, making sure that the operator comprehends its contents.

Owner and/or user must study and maintain for future reference the manufacturers' instructions.

The operator must know how to stop the machine quickly and understand the operation of all controls. Never permit anyone to operate the engine without proper instructions.

SAVE THESE INSTRUCTIONS

This manual should be considered a permanent part of the machine and should remain with it if machine is resold.

When ordering parts, please specify model and serial number. Use only identical replacement parts. This machine is to be used only by trained operators.

IMPORTANT SAFETY INFORMATION

WARNING



READ OPERATOR'S MANUAL THOROUGHLY PRIOR TO USE.

WARNING: To reduce the risk of injury, read operating instructions carefully before using.

1. Read the owner's manual thoroughly. Failure to follow instructions could cause malfunction of the machine and result in death, serious bodily injury and/or property damage.
2. Know how to stop the machine and bleed pressure quickly. Be thoroughly familiar with the controls.
3. Stay alert — watch what you are doing.
4. All installations must comply with local codes. Contact your electrician, plumber, utility company or the selling distributor for specific details. If your machine is rated 250 volts or less, single phase will be provided with a ground fault circuit interrupter (GFCI). If rated more than 250 volts, or more than single phase this product should only be connected to a power supply receptacle protected by a GFCI.

DANGER: Improper connection of the equipment-grounding conductor can result in a risk of electrocution. Check with a qualified electrician or service personnel if you are in doubt as to whether the outlet is properly grounded. Do not modify the plug provided with the product - if it will not fit the outlet, have a proper outlet installed by a qualified electrician. Do not use any type of adaptor with this product

WARNING



KEEP WATER SPRAY AWAY FROM ELECTRICAL WIRING.

WARNING: Keep wand, hose, and water spray away from electric wiring or fatal electric shock may result.

5. To protect the operator from electrical shock, the machine must be electrically grounded. It is the responsibility of the owner to connect this machine to a UL grounded receptacle of proper voltage and amperage ratings. Do not spray water on or near electrical components. Do not touch machine with wet hands or while standing in water. Always disconnect power before servicing.

WARNING



RISK OF EXPLOSION: DO NOT SPRAY FLAMMABLE LIQUIDS.

WARNING: Flammable liquids can create fumes which can ignite, causing property damage or severe injury.

WARNING: Risk of explosion — Do not spray flammable liquids.

6. Do not allow acids, caustic or abrasive fluids to pass through the pump.
7. Never run pump dry or leave spray gun closed longer than 1-2 minutes.
8. Keep operating area clear of all persons.

WARNING



USE PROTECTIVE EYE WEAR AND CLOTHING WHEN OPERATING THIS EQUIPMENT.

WARNING: High pressure spray can cause paint chips or other particles to become airborne and fly at high speeds. To avoid personal injury, eye, hand and foot safety devices must be worn.

9. Eye, hand, and foot protection must be worn when using this equipment.

IMPORTANT SAFETY INFORMATION

! WARNING



TRIGGER GUN KICKS BACK - HOLD WITH BOTH HANDS

WARNING: Grip cleaning wand securely with both hands before starting. Failure to do this could result in injury from a whipping wand.

! WARNING



RISK OF INJECTION OR SEVERE INJURY TO PERSONS. KEEP CLEAR OF NOZZLE.

WARNING: High pressure developed by these machines will cause personal injury or equipment damage. Keep clear of nozzle. Use caution when operating. Do not direct discharge stream at people, or severe injury or death will result.

10. To reduce the risk of injury, close supervision is necessary when a machine is used near children. Do not allow children to operate the pressure washer. **This machine must be attended during operation.**
11. Never make adjustments on machine while in operation.
12. Be certain all quick coupler fittings are secured before using pressure washer.

! WARNING



PROTECT FROM FREEZING

WARNING: Protect machine from freezing.

13. To keep machine in best operating conditions, it is important you protect machine from freezing. Failure to protect machine from freezing could cause malfunction of the machine and result in death,

serious bodily injury, and/or property damage. Follow storage instructions specified in this manual.

14. Inlet water must be clean fresh water and no hotter than 90°F.
15. Manufacturer will not be liable for any changes made to our standard machines or any components not purchased from us.
16. The best insurance against an accident is precaution and knowledge of the machine.

! WARNING



RISK OF INJURY FROM FALLS WHEN USING LADDER.

WARNING: Be extremely careful when using a ladder, scaffolding or any other relatively unstable location. The cleaning area should have adequate slopes and drainage to reduce the possibility of a fall due to slippery surfaces.

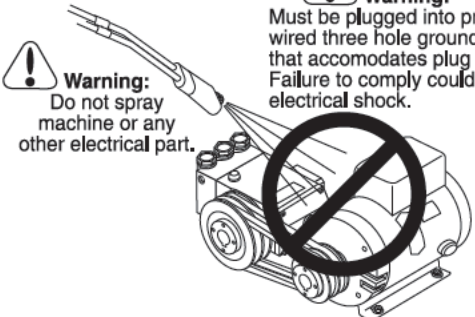

! Warning: Must be plugged into properly wired three hole grounded outlet that accommodates plug on power cord. Failure to comply could result in electrical shock.

! Warning: Do not spray machine or any other electrical part.

17. Do not overreach or stand on unstable support. Keep good footing and balance at all times.
18. Do not operate this machine when fatigued or under the influence of alcohol, prescription medications, or drugs.



Follow the maintenance instructions specified in the manual.

COMPONENT IDENTIFICATION

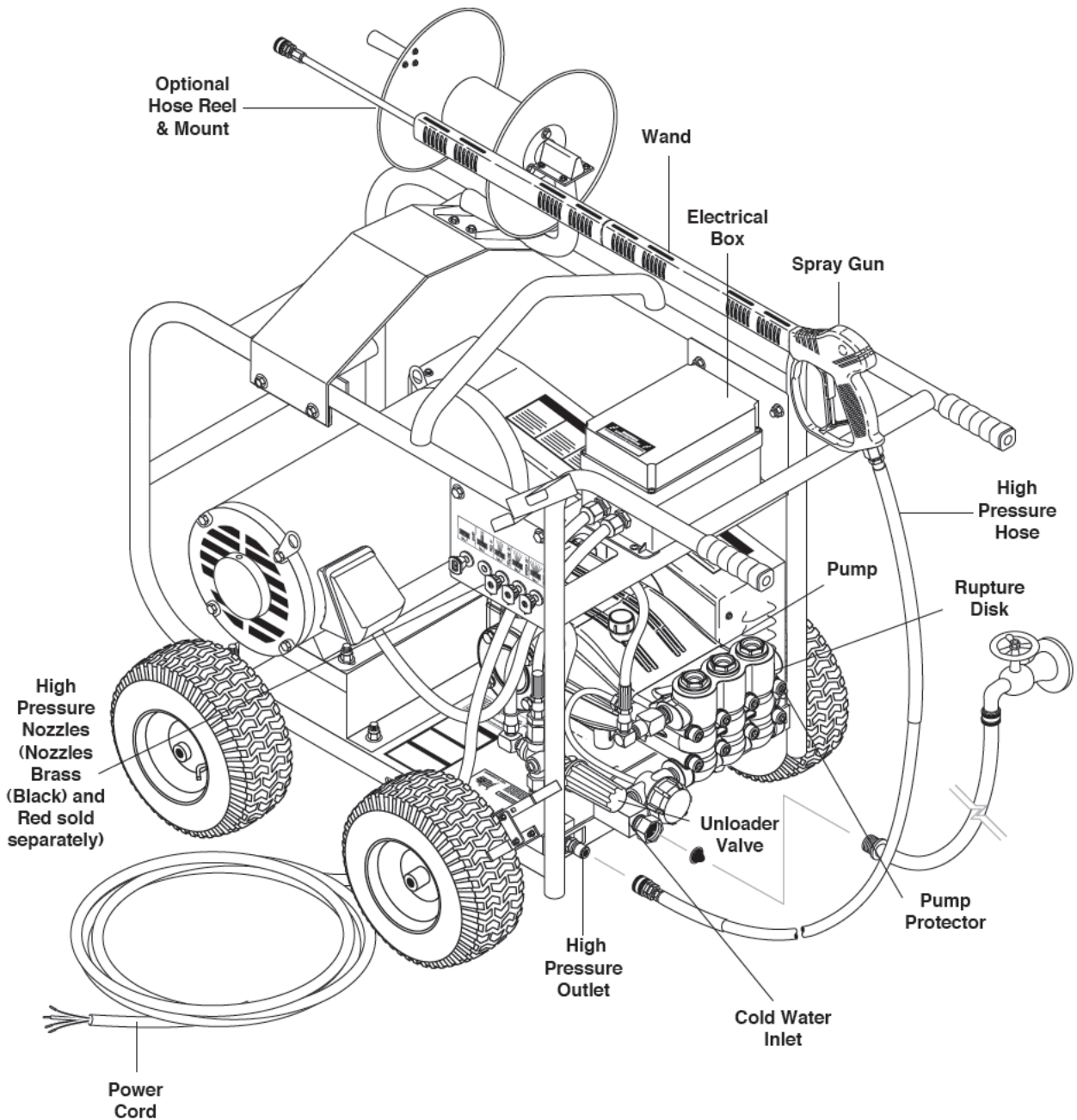

Pump — Delivers a specific gpm to the high pressure nozzle which develops pressure.

Spray Gun — Controls the application of water and detergent onto cleaning surface with trigger device. Includes safety latch.

Detergent Injector — Allows you to siphon and mix detergents (Not Shown).

Wand — Must be connected to the spray gun.

High Pressure Hose — Connect one end to water pump high pressure discharge nipple and the other end to spray gun.

Rupture Disk — Secondary pressure release in the unlikely event the unloader valve fails.

Unloader Valve — Safety device which, when the spray gun closes, prevents over pressurization.

Note: If trigger on spray gun is released for more than 1-2 minutes, water will leak from the pump protector. Warm water will discharge from pump protector onto floor. This system prevents internal pump damage.

ASSEMBLY INSTRUCTIONS

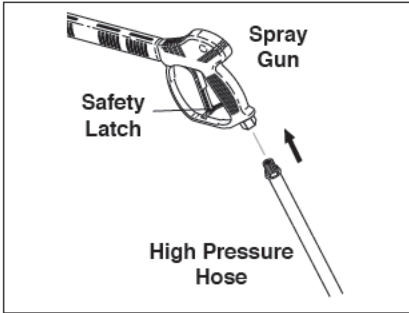

STEP 1: Attach the high pressure hose to the spray gun using teflon tape on hose threads.

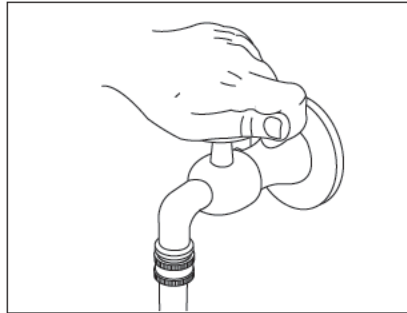

STEP 2: Before installing nozzle, turn on water supply and run machine allowing water to flush through the system until clear.

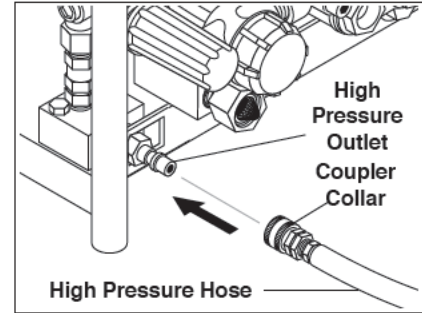

STEP 3: Connect the high pressure hose to the high pressure outlet. Push coupler collar forward until secure.

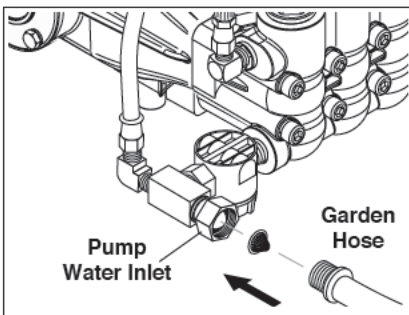

STEP 4: Connect the garden hose to pump water inlet. Inspect inlets. **CAUTION: Do not run the pump without water or pump damage will result.**

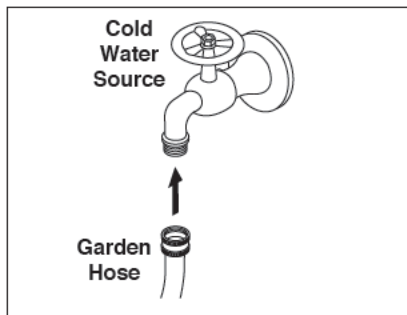

STEP 5: Connect garden hose to the cold water source.

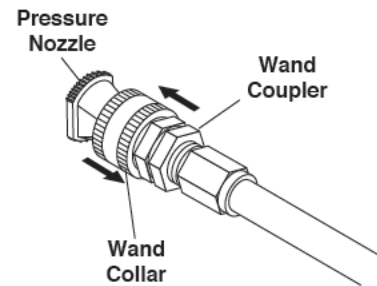

STEP 6: Pull the spring-loaded collar of the wand coupler back to insert your choice of pressure nozzle. Release the coupler collar and push the nozzle until the collar clicks. Pull the nozzle to make sure it is seated properly.

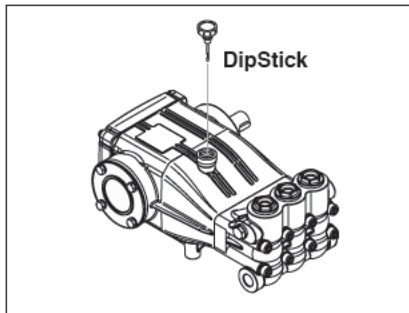

STEP 7: Remove shipping cap and install oil dipstick. Check pump oil level by using dipstick or observe oil level in oil window (if equipped). Use 40 wt. (non detergent) oil.

OPERATING INSTRUCTIONS

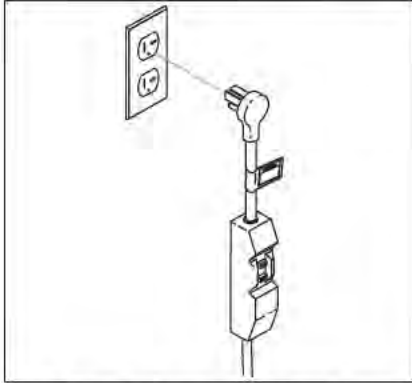

STEP 1: Connect machine to adequate power source. Push reset button on GFCI if equipped.

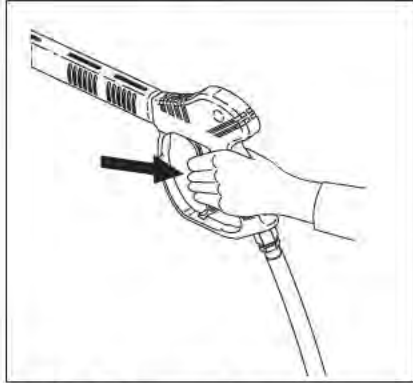

STEP 2: Trigger the spray gun to eliminate trapped air then wait for a steady flow of water to emerge from the spray wand. Then install nozzle.

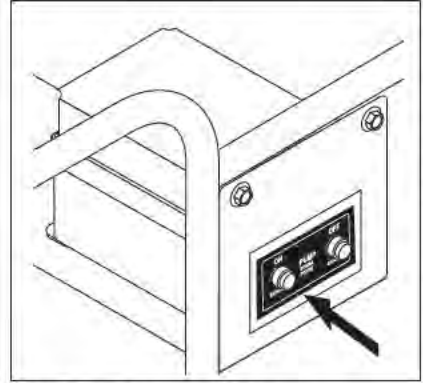

STEP 3: Turn machine on.

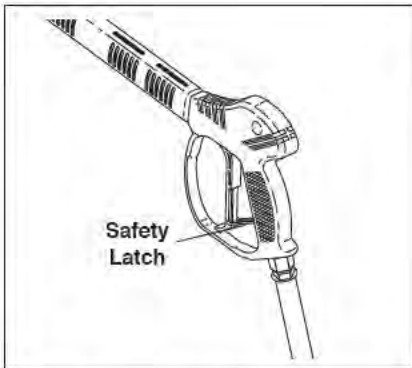

WARNING! Never replace nozzles without engaging the safety latch on the spray gun trigger.

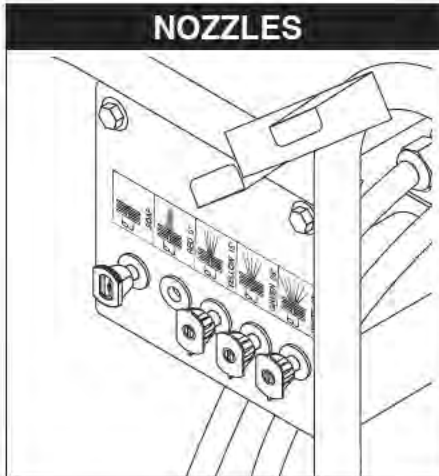

The four color-coded quick connect nozzles provide a wide array of spray widths from 15° to 40° and are easily accessible when placed in the convenient rubber nozzle holder, which is provided on the front of the machine.

NOTE: For a more gentle rinse, select the white 40° or green 25° nozzle. To scour the surface, select the yellow 15° nozzle. To apply detergent select the black soap nozzle.

*Nozzles Brass (Black) sold separately.

APPLYING DETERGENT & GENERAL OPERATING TECHNIQUES



WARNING

WARNING: Some detergents may be harmful if inhaled or ingested, causing severe nausea, fainting or poisoning. The harmful elements may cause property damage or severe injury.

STEP 1: Connect detergent injector to high pressure outlet on machine. Connect high pressure hose to injector with quick coupler. (Check to make sure locking coupler sleeves are in proper position before applying water pressure.)

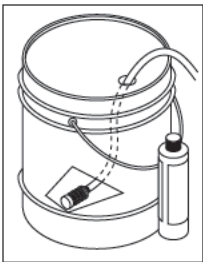
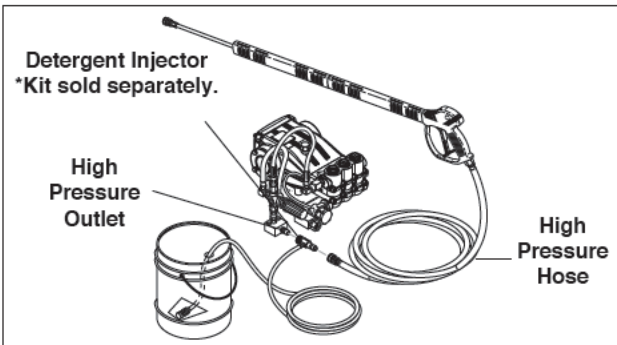

STEP 2: Use detergent designed specifically for pressure washers. Household detergents could damage the pump. Prepare detergent solution as required by the manufacturer. Fill a container with pressure washer detergent. Place the filter end of detergent suction tube into the detergent container.

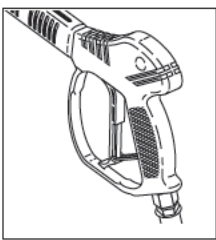

STEP 3: With safety latch on spray gun engaged, secure black detergent nozzle into quick coupler. **NOTE:** Detergent cannot be applied using yellow, green or white nozzles.

STEP 4: With the motor running, pull trigger to operate machine. Liquid detergent is drawn into the machine and mixed with water. Apply detergent to work area. Do not allow detergent to dry on surface.

IMPORTANT: You must flush the detergent injection system after each use by placing the suction tube into a bucket of clean water, then run the pressure washer in low pressure for 1-2 minutes.

THERMAL PUMP PROTECTOR

If you run the engine on your pressure washer for 1-2 minutes without pressing the trigger on the spray

gun, circulating water in the pump can reach high temperatures. When the water reaches this temperature, the pump protector engages and cools the pump by discharging the warm water onto the ground. This thermal device prevents internal damage to the pump.

CLEANING TIPS

Pre-rinse cleaning surface with fresh water. Place detergent suction tube directly into cleaning solution and apply to surface at low pressure (for best results, limit your work area to sections approximately 6 feet square and always apply detergent from bottom to top). Allow detergent to remain on surface 1-3 minutes. Do not allow detergent to dry on surface. If surface appears to be drying, simply wet down surface with fresh water. If needed, use brush to remove stubborn dirt. Rinse at high pressure from top to bottom in an even sweeping motion keeping the spray nozzle approximately 1 foot from cleaning surface. Use overlapping strokes as you clean and rinse any surface. For best surface cleaning action spray at a slight angle.

Recommendations:

- Before cleaning any surface, an inconspicuous area should be cleaned to test spray pattern and distance for maximum cleaning results.
- If painted surfaces are peeling or chipping, use extreme caution as pressure washer may remove the loose paint from the surface.
- Keep the spray nozzle a safe distance from the surface you plan to clean. High pressure wash a small area, then check the surface for damage. If no damage is found, continue to pressure washing.



CAUTION - Never use:

- Bleach, chlorine products and other corrosive chemicals
- Liquids containing solvents (i.e., paint thinner, gasoline, oils)
- Tri-sodium phosphate products
- Ammonia products
- Acid-based products

These chemicals will harm the machine and will damage the surface being cleaned.

RINSING

It will take a few seconds for the detergent to clear. Apply safety latch to spray gun. Remove black soap nozzle from the quick coupler. Select and install the desired high pressure nozzle. **NOTE:** You can also stop detergent from flowing by simply removing detergent siphon tube from bottle.

SHUT DOWN AND CLEAN-UP

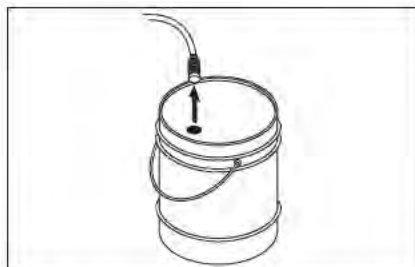

STEP 1: Remove detergent suction tube from container and insert into one gallon of fresh water. For low pressure connect the black detergent nozzle. Pull trigger on spray gun and siphon water for one minute.

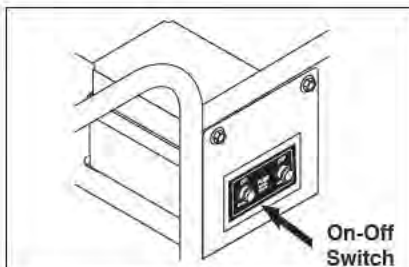

STEP 2: Turn off the motor.

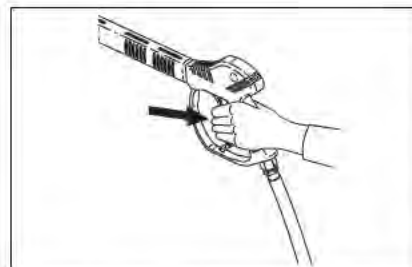

STEP 3: Press trigger to release water pressure.

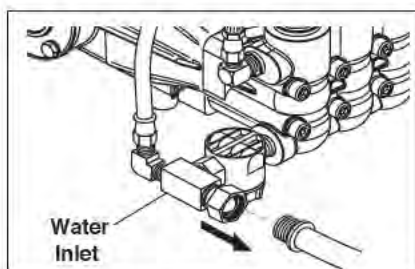

STEP 4: Disconnect the garden hose from the water inlet on the machine.

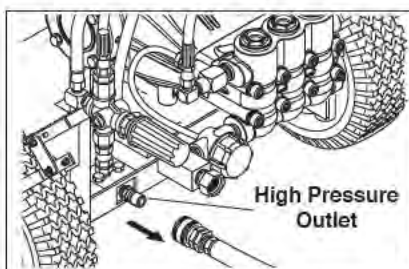

STEP 5: Disconnect the high pressure hose from high pressure outlet.



STEP 6: Engage the spray gun safety lock.

STORAGE

Pump Storage



CAUTION

CAUTION: Always store your pressure washer in a location where the temperature will not fall below 32° F (0° C). The pump in this machine is susceptible to permanent damage if frozen.

FREEZE DAMAGE IS NOT COVERED BY WARRANTY.

If you must store your pressure washer in a location where the temperature is below 32° F, you can minimize the chance of damage to your machine by draining your machine as follows:

1. Stop the pressure washer and detach supply hose and high pressure hose. Squeeze the trigger of the spray gun to drain all water from the wand and hose.
2. Restart pressure washer and let it run briefly (about 5 seconds) until water no longer discharges from the high pressure outlet.

In temperatures below 32° you may connect a bulkhead fitting to the bottom of a bucket then attach a garden hose to siphon anti-freeze into the pump.

TROUBLESHOOTING

| PROBLEM | POSSIBLE CAUSE | SOLUTION |
|---------------------------------------------------------------|-------------------------------------------------------|---------------------------------------------------------------------------------------------------------------------------------|
| PUMP RUNNING NORMALLY BUT PRESSURE LOW ON INSTALLATION | Pump sucking air | Check water supply and possibility of air seepage. |
| | Check valves sticking | Check and clean or replace if necessary. |
| | Unloader valve seat faulty | Check and replace if necessary. |
| | Nozzle incorrectly sized | Check and replace if necessary. |
| | Worn piston packing | Check and replace if necessary. |
| FLUCTUATING PRESSURE | Valves worn | Check and replace if necessary. |
| | Blockage in valve | Check and clean out if necessary. |
| | Faulty or misadjusted unloader valve | Tampering with the factory setting may cause personal injury and/or property damage, and will void the manufacturer's warranty. |
| | Pump sucking air | Check water supply connections. |
| | Worn piston packing | Check and replace if necessary. |
| | Insufficient water | Check filter and hose for breakage. |
| PRESSURE LOW AFTER PERIOD OF NORMAL USE | Nozzle worn | Check and replace if necessary. |
| | Suction or delivery valves worn | Check and replace if necessary. |
| | Suction or delivery valves blocked | Check and clean if necessary. |
| | Unloader valve seat worn | Check and replace if necessary. |
| | Worn piston package | Check and replace if necessary. |
| PUMP NOISY | Air in suction line | Check water supply and connections on suction line. |
| | Broken or weak suction or delivery valve spring | Check and replace if necessary. |
| | Foreign matter in valves | Check and clean if necessary. |
| | Worn bearings | Check and replace if necessary. |
| | Excessive temperature of water | Reduce to below 140°F. |
| PRESENCE OF WATER IN PUMP OIL | Oil seal worn | Check and replace if necessary. |
| | High humidity in air | Check and change oil twice as often. |
| | Piston packing worn | Check and replace if necessary. |
| WATER DRIPPING FROM UNDER PUMP | Piston packing worn | Check and replace if necessary. |
| | O-Ring plunger retainer worn | Check and replace if necessary. |
| WATER DRIPPING FROM PUMP PROTECTOR | Water supply pressure too high (over 90 psi) | Lower water supply pressure using a regulator. |
| | Spray gun is in the off position for over 1-2 minutes | Turn machine off if not in use for over 1-2 minutes. |
| OIL DRIPPING | Oil seal worn | Check and replace if necessary. |
| EXCESSIVE VIBRATION IN HIGH-PRESSURE HOSE | Irregular functioning of the pump valves | Check and replace if necessary |

PREVENTATIVE MAINTENANCE

This pressure washer was produced with the best available materials and quality craftsmanship. However, you as the owner have certain responsibilities for the correct care of the equipment. Attention to regular preventative maintenance procedures will assist in preserving the performance of your equipment. Contact your dealer for maintenance. Regular preventative maintenance will add many hours to the life of your pressure washer. Perform maintenance more often under severe conditions.

| | | |
|-----------------------------------------|---------|--------------------------------------------------------|
| Pump Oil (Non foaming) SAE 10W-40 | Inspect | Daily inspect the oil level |
| | Change | After first 50 hours, then every 500 hours or annually |
| Replace high pressure nozzle | | Every 6 months |
| Replace quick connects | | Annually |
| Clean water screen/filter | | Weekly |
| Replace HP hose | | Annually if there is any sign of wear |
| Grease motor | | Every 10,000 hour |
| Belt Tension/Inspection | | Daily |
| Check Air Pressure in Tires | | Daily |

OIL CHANGE RECORD

Check pump oil and engine oil level before first use of your new pressure washer.

| Date Oil Changed Month/Day/Year | Estimated Operating Hours Since Last Oil Change |
|------------------------------------|-------------------------------------------------------|
| | |
| | |
| | |
| | |
| | |
| | |
| | |
| | |
| | |
| | |
| | |
| | |
| | |
| | |
| | |
| | |

| Date Oil Changed Month/Day/Year | Estimated Operating Hours Since Last Oil Change |
|------------------------------------|-------------------------------------------------------|
| | |
| | |
| | |
| | |
| | |
| | |
| | |
| | |
| | |
| | |
| | |
| | |
| | |
| | |
| | |
| | |
| | |

HOSE & SPRAY GUN ASSEMBLY

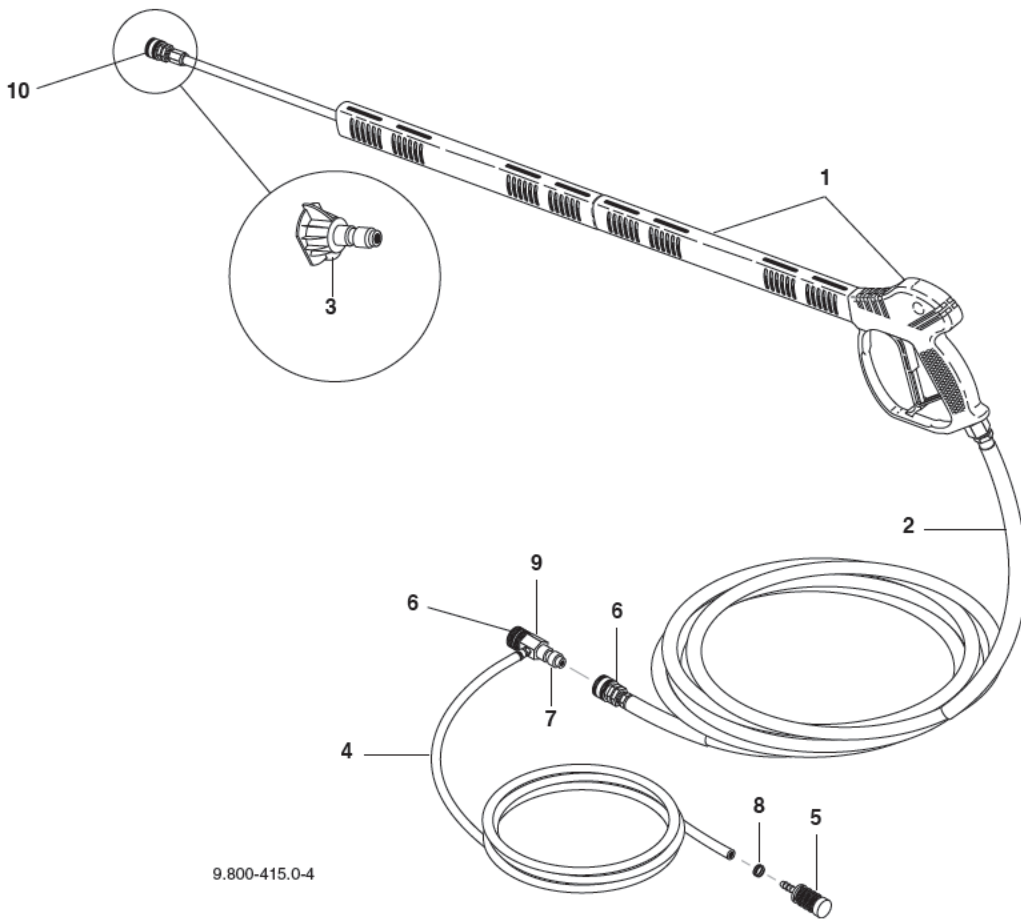

HOSE & SPRAY GUN ASSEMBLY PARTS LIST

| ITEM | PART NO. | DESCRIPTION | QTY | ITEM | PART NO. | DESCRIPTION | QTY |
|------|-------------|--------------------------------------------------------------------|-----|------|-------------|----------------------------------------------|-------|
| 1 | 9.802-228.0 | Gun w/Wand (5000 PSI), w/Coupler | 1 | 4 | 9.802-251.0 | Hose, 1/4" x 1/2" Clear Vinyl | 6 ft. |
| 2 | 8.918-088.0 | Hose, 3/8" x 50', 2W, TS,SO-SW,HIGH PRESS CP (MPE, BDE,BRE and HD) | 1 | 5 | 9.802-160.0 | Strainer, Plastic, 1/4" Hose Barb | 1 |
| 3 | 9.803-811.0 | Nozzle, SAQCMEG 15045, Yellow | 1 | 6 | 9.802-167.0 | Coupler, 3/8" Fem, 11,000 PSI, Snap-Tite | 1 |
| | 9.803-812.0 | Nozzle, SAQCMEG 25045, Green | 1 | 7 | 9.802-168.0 | Nipple, 3/8" Fem, 11,000 PSI | 1 |
| | 9.803-813.0 | Nozzle, SAQCMEG 4004.5, White | 1 | 8 | 6.390-126.0 | Clamp, Hose, .46-.54 ST | 2 |
| | 9.802-311.0 | Nozzle COMPL, QCCEM-6540 Brass | 1 | 9 | 9.802-167.0 | Injector, SS, Non Adj, 2.0-4.0 GPM, 5500 PSI | 1 |
| | | | | 10 | 8.756-030.0 | Coupler, 1/4" Socket, Male, Brass | 1 |



THANK YOU!
MERCI! DANKE! ¡GRACIAS!



Registrieren Sie Ihr Produkt und profitieren Sie von vielen Vorteilen.

Register your product and benefit from many advantages.

Enregistrez votre produit et bénéficiez de nombreux avantages.

Registre su producto y aproveche de muchas ventajas.

www.kaercher.com/welcome



Bewerten Sie Ihr Produkt und sagen Sie uns Ihre Meinung.

Rate your product and tell us your opinion.

Évaluer votre produit et dites-nous votre opinion.

Reseñe su producto y díganos su opinión.



www.kaercher.com/dealersearch

Alfred Kärcher SE & Co. KG
Alfred-Kärcher-Str. 28-40
71364 Winnenden (Germany)
Tel.: +49 7195 14-0
Fax: +49 7195 14-2212



Section 1: IDENTIFICATION**Product Name:** Extreme Simple Green® Aircraft & Precision Cleaner**Additional Names:****Manufacturer's Part Number:** *Please refer to Section 16**Recommended Use:** Cleaner and degreaser formulated to safely remove, oil, grease, and grime.**Restrictions on Use:** Do not use on non-rinsable or asphalt surfaces**Company:** Sunshine Makers, Inc.

15922 Pacific Coast Highway

Huntington Beach, CA 92649 USA

Telephone: 800-228-0709 • 562-795-6000 Mon – Fri, 8am – 5pm PST**Fax:** 562-592-3830**Email:** info@simplegreen.com**Emergency Phone:** Chem-Tel 24-Hour Emergency Service: 800-255-3924**Section 2: HAZARDS IDENTIFICATION****This product is considered hazardous (Eye Corrosive/Irritant – Category 2B) by the 2012 OSHA Hazard Communication Standard (29 CFR 1910.1200)**OSHA HCS 2012Label Elements**Signal Word:** Warning**Hazard Symbol(s)/Pictogram(s):** None required**Hazard Statements:**

H320 – Causes Eye Irritation.

Precautionary Statements:

P264 – Wash hands thoroughly after handling.

P305+P351+P338 – IF IN EYES: Rinse cautiously with water for several minutes. Remove contact lenses, if present and easy to do. Continue rinsing.

P337+P313 – If eye irritation persists: Get medical advice.

Hazards Not Otherwise Classified (HNOC): No hazards not otherwise classified were identified**Other Information:** None Known.**Section 3: COMPOSITION/INFORMATION ON INGREDIENTS**

| <u>Ingredient</u> | <u>CAS Number</u> | <u>Percent Range</u> |
|------------------------------|-------------------|----------------------|
| Water | 7732-18-5 | > 78%* |
| Triethanolamine | 102-71-6 | ≤ 10%* |
| Ethoxylated Alcohol | 68439-46-3 | ≤ 5%* |
| Propylene Glycol Butyl Ether | 5131-66-8 | < 5%* |
| Tetrapotassium Pyrophosphate | 7320-34-5 | < 1%* |
| Potassium Silicate | 1312-76-1 | < 1%* |

*specific percentages of composition are being withheld as a trade secret

Section 4: FIRST-AID MEASURES**Inhalation:** Not expected to cause respiratory irritation. If adverse effect occurs, move to fresh air.**Skin Contact:** Not expected to cause skin irritation. If adverse effect occurs, rinse skin with water.**Eye Contact:** Rinse cautiously with water for several minutes. Remove contact lenses, if present and easy to do. Continue rinsing. If eye irritation persists: Get medical advice.**Ingestion:** May cause upset stomach. Drink plenty of water to dilute. See section 11.**Most Important Symptoms/Effects, Acute and Delayed:** None known.**Indication of Immediate Medical Attention and Special Treatment Needed, if necessary:** Treat symptomatically

Section 5: FIRE-FIGHTING MEASURES

Suitable & Unsuitable Extinguishing Media: Use Dry chemical, CO₂, water spray or “alcohol” foam. Avoid high volume jet water.
Specific Hazards Arising from Chemical: In event of fire, fire created carbon oxides and oxides of phosphorus may be formed.
Special Protective Actions for Fire-Fighters: Wear positive pressure self-contained breathing apparatus; Wear full protective clothing.

This product is non-flammable. See Section 9 for Physical Properties.

Section 6: ACCIDENTAL RELEASE MEASURES

Personal Precautions, Protective Equipment and Emergency Procedures:

For non-emergency personnel: See section 8 – personal protection.

For emergency responders: Avoid eye contact. Safety goggles suggested if splashing or misting is likely to occur.

Environmental Precautions: Do not allow into open waterways and ground water systems.

Methods and Materials for Containment and Clean Up: Dike or soak up with inert absorbent material. See section 13 for disposal considerations.

Section 7: HANDLING AND STORAGE

Precautions for Safe Handling: Ensure adequate ventilation. Keep out of reach of children. Keep away from heat, sparks, open flame and direct sunlight. Do not pierce any part of the container. Do not mix or contaminate with any other chemical. Do not eat, drink or smoke while using this product.

Conditions for Safe Storage including Incompatibilities: Keep container tightly closed. Keep in cool dry area. Avoid prolonged exposure to sunlight. Do not store at temperatures above 109°F (42.7°C). If separation occurs, mix the product for reconstitution.

Section 8: EXPOSURE CONTROLS / PERSONAL PROTECTION

| | | | |
|-------------------------------|----------------------------|---------------------------------------|------------------------------------------------------------------------|
| Exposure Limit Values: | Triethanolamine (102-71-6) | 5 mg/m ³ PEL | California |
| | Diethanolamine (111-42-2) | 3 ppm TWA; 15 mg/m ³ TWA | Connecticut, Michigan, Minnesota, OSHA, Tennessee, Vermont, Washington |
| | | 0.46 ppm PEL; 2 mg/m ³ PEL | California |
| | | 6 ppm STEL | Washington |

Appropriate Engineering Controls: Showers, eyewash stations, ventilation systems

Individual Protection Measures / Personal Protective Equipment (PPE)

Eye Contact: Use protective glasses or safety goggles if splashing or spray-back is likely.

Respiratory: Use in well ventilated areas or local exhaust ventilations when cleaning small spaces.

Skin Contact: Use protective gloves (any material) when used for prolonged periods or dermally sensitive.

General Hygiene Considerations: Wash thoroughly after handling and before eating or drinking.

Section 9: PHYSICAL AND CHEMICAL PROPERTIES

| | | | |
|-----------------------------------|----------------|------------------------------------------------|----------------------------------------------|
| Appearance: | Clear Liquid | Partition Coefficient: n-octanol/water: | Not determined |
| Odor: | No added odor | Autoignition Temperature: | Non-flammable |
| Odor Threshold: | Not determined | Decomposition Temperature: | 109°F |
| pH: | 10 – 11.5 | Viscosity: | Like water |
| Freezing Point: | 0°C (32°F) | Specific Gravity : | 1.01 – 1.04 |
| Boiling Point & Range: | 98°C (210°F) | VOCs: | **Water & fragrance exemption in calculation |
| Flash Point: | > 212°F | CARB Method 310**: | 20 g/L 0.1667 lb/gal 2.0% |
| Evaporation Rate: | Not determined | VOC Composite Partial Pressure: | 0.102207135 |
| Flammability (solid, gas): | Not applicable | | |

Section 9: PHYSICAL AND CHEMICAL PROPERTIES - continued

| | | | |
|------------------------------------------------------|--------------------|--------------------------|-----------------------|
| Upper/Lower Flammability or Explosive Limits: | Not applicable | Nutrient Content: | |
| Vapor Pressure : | 20.7 mmHg | Nitrogen - | <0.1% (0% by formula) |
| Vapor Density: | Not determined | Phosphorous - | < 0.25% (by formula) |
| Relative Density: | 8.34 – 8.67 lb/gal | Sulfur - | <0.1% (0% by formula) |
| Solubility: | 100% in water | | |

Section 10: STABILITY AND REACTIVITY

| | |
|--------------------------------------------|------------------------------------------------------------------------------|
| Reactivity: | Non-reactive. |
| Chemical Stability: | Stable under normal conditions 70°F (21°C) and 14.7 psig (760 mmHg). |
| Possibility of Hazardous Reactions: | None known. |
| Conditions to Avoid: | Excessive heat or cold. |
| Incompatible Materials: | Do not mix with oxidizers, acids, bathroom cleaners, or disinfecting agents. |
| Hazardous Decomposition Products: | Normal products of combustion - CO, CO ₂ , oxides of phosphorus. |

Section 11: TOXICOLOGICAL INFORMATION

| | | |
|-----------------------------------|----------------|-----------------------------------|
| Likely Routes of Exposure: | Inhalation - | Overexposure may cause headache. |
| | Skin Contact - | Not expected to cause irritation. |
| | Eye Contact - | Causes eye irritation. |
| | Ingestion - | May cause upset stomach. |

Symptoms related to the physical, chemical and toxicological characteristics: no symptoms expected under typical use conditions.

Delayed and immediate effects and or chronic effects from short term exposure: no symptoms expected under typical use conditions.

Delayed and immediate effects and or chronic effects from long term exposure: headache, dry skin, or skin irritation may occur.

Interactive effects: Not known.

Numerical Measures of Toxicity

| | | |
|------------------------|----------------------------------|----------------------|
| Acute Toxicity: | Oral LD ₅₀ (rat) | > 5 g/kg body weight |
| | Dermal LD ₅₀ (rabbit) | > 5 g/kg body weight |

Calculated via OSHA HCS 2012 / Globally Harmonized System of Classification and Labelling of Chemicals

| | |
|-----------------------------------|------------------------------------------------------------------------------------------------------------------------------------------------------|
| Skin Corrosion/Irritation: | Non-irritant per Dermal Irritation ^o assay modeling. <i>No animal testing performed.</i> |
| Eye Damage/Irritation: | Irritant per Ocular Irritation ^o assay modeling. <i>No animal testing performed.</i> |
| Germ Cell Mutagenicity: | Mixture does not classify under this category. |
| Carcinogenicity: | Volume of ingredients does not trigger or classify under this category. This product contains trace amounts of Diethanolamine (IARC 2B and ACGIH A3) |
| Reproductive Toxicity: | Mixture does not classify under this category. |
| STOT-Single Exposure: | Mixture does not classify under this category. |
| STOT-Repeated Exposure: | Mixture does not classify under this category. |
| Aspiration Hazard: | Mixture does not classify under this category. |

Section 12: ECOLOGICAL INFORMATION

Ecotoxicity: Volume of ingredients used does not trigger toxicity classifications under the Globally Harmonized System of Classification and Labelling of Chemicals.

Aquatic: Not tested on finished formulation.

Terrestrial: Not tested on finished formulation.

| | |
|---------------------------------------|----------------------------------------------------------|
| Persistence and Degradability: | Readily Biodegradable per OECD 301D, Closed Bottle Test. |
| Bioaccumulative Potential: | No data available. |
| Mobility in Soil: | No data available. |
| Other Adverse Effects: | No data available. |

Section 13: DISPOSAL CONSIDERATIONS

Unused or Used Liquid: May be considered hazardous in your area depending on usage and tonnage of disposal – check with local, regional, and or national regulations for appropriate methods of disposal.

Empty Containers: May be offered for recycling.

Never dispose of used degreasing rinsates into lakes, streams, and open bodies of water or storm drains.

Section 14: TRANSPORT INFORMATION

| | | | |
|-------------------------------------------------------------------------------------------------------------------------------------------------------------|-----------------------------|-----------------------------------|-------------------------------|
| U.N. Number: | Not applicable | U.N. Proper Shipping Name: | Cleaning Compound, Liquid NOI |
| Transport Hazard Class(es): | Not applicable | | |
| Packing Group: | Not applicable | | |
| Environmental Hazards: | Marine Pollutant - NO | | |
| Transport in Bulk (according to Annex II of MARPOL 73/78 and IBC Code): | Unknown. | | |
| Special precautions which user needs to be aware of/comply with, in connection with transport or conveyance either within or outside their premises: | None known. | | |
| U.S. (DOT) / Canadian TDG: | Not Regulated for shipping. | ICAO/ IATA: | Not classified as Hazardous |
| IMO / IDMG: | Not classified as Hazardous | ADR/RID: | Not classified as Hazardous |

Section 15: REGULATORY INFORMATION

All components are listed on: TSCA and DSL Inventory.

SARA Title III: Sections 311/312 – Not applicable.
 Sections 313 Superfunds Amendments and Reauthorizations Act of 1986 – Diethanolamine (111-42-2) < 0.01%
 Sections 302 – Not applicable.

Clean Air Act (CAA): Triethanolamine (102-71-6), Diethanolamine (111-42-2), Propylene Glycol Butyl Ether (5131-66-8)
Clean Water Act (CWA): Not applicable
CERCLA: Diethanolamine (111-42-2) 100 lb RQ

State Right To Know Lists: Triethanolamine (102-71-6) Massachusetts, New Jersey, Pennsylvania
 Diethanolamine (111-42-2) Massachusetts, New Jersey, Pennsylvania

CA Proposition 65: Diethanolamine (111-42-2) < 0.01%

Texas ESL:

| | | | |
|------------------------------|------------|--------------------------------|----------------------------------|
| Triethanolamine | 102-71-6 | 5 µg/m ³ long term | 50 µg/m ³ short term |
| Ethoxylated Alcohol | 68439-46-3 | 60 µg/m ³ long term | 600 µg/m ³ short term |
| Propylene Glycol Butyl Ether | 5131-66-8 | 73 µg/m ³ long term | 730 µg/m ³ short term |
| Tetrapotassium Pyrophosphate | 7320-34-5 | 5 µg/m ³ long term | 50 µg/m ³ short term |
| Potassium Silicate | 1312-76-1 | | 5 µg/m ³ short term |
| Diethanolamine | 111-42-2 | 1 µg/m ³ long term | 10 µg/m ³ short term |

Section 16: OTHER INFORMATION

| <u>Size</u> | <u>UPC</u> |
|----------------------|--------------|
| 1 Gallon | 043318134067 |
| 1 Gallon, 4 per case | 043318134067 |
| 5 Gallon | 043318134050 |
| 55 Gallon | 043318134555 |
| 275 Gallon | 043318134753 |

USA part numbers listed only. Not all part numbers listed. USA part numbers may not be valid for international sale.

Section 16: OTHER INFORMATION - continued

NFPA:

Health – Eye Irritant

Flammability – Non-flammable

Stability – Stable

Special - None



Acronyms

NTP National Toxicology Program

OSHA Occupational Safety and Health Administration

TSCA Toxic Substances Control Act

IARC International Agency for Research on Cancer

CPSC Consumer Product Safety Commission

DSL Domestic Substances List

Prepared / Revised By: Sunshine Makers, Inc., Regulatory Department.

This SDS has been revised in the following sections: Modification to section 9 and 16

DISCLAIMER: The information provided in this Safety Data Sheet is correct to the best of our knowledge, information and belief at the date of its publication. The information given is designed only as guidance for safe handling, use, processing, storage, transportation, disposal and release and is not to be considered a warranty or quality specification. The information relates only to the specific material designated and may not be valid for such material used in combination with any other materials or in any process, unless specified in the text.

ATTACHMENT 5B: ENVIRONMENTAL PROTECTION PLAN - REDACTED

[RETURN TO TABLE OF CONTENTS](#)



ENVIRONMENTAL PROTECTION PLAN

Clean Red Hill Tanks, JBPHH, Hawaii Joint Base Pearl Harbor-Hickam Oahu, Hawaii

JANUARY 2024

Naval Facilities Engineering Command
[REDACTED]

[REDACTED]
Task Order [REDACTED]

Revision: 0

Department of the Navy, Naval Facilities
Engineering and Expeditionary Warfare Center

Submitted by:
[REDACTED]

Procurement sensitive and proprietary information – This information is exempt from disclosure under 5. U.S.C. § 552(b)(4) because it contains proprietary and procurement sensitive information.

ENVIRONMENTAL PROTECTION PLAN AMENDMENTS



| Date | Change Needed | Change Made |
|------|---------------|-------------|
| | | |
| | | |
| | | |
| | | |
| | | |

Distribution authorized to U.S. Government Agencies only;
Other requests shall be referred to NAVFAC HI.



CONTENTS

| | | |
|------------|----------------------------------------------------------------------------------------|-----------|
| 1.0 | General Overview | 1 |
| 1.1 | General Overview and Purpose..... | 1 |
| 1.2 | Separate Plans | 1 |
| 1.3 | Environmental Manager Personnel | 1 |
| 1.4 | Operating Procedures | 2 |
| 1.4.1 | Contingency Plan | 2 |
| 1.5 | Communication and Training..... | 2 |
| 1.6 | General Site Information..... | 3 |
| 2.0 | Management of Natural Resources | 5 |
| 2.1 | Land Resources | 5 |
| 2.2 | Tree Protection | 5 |
| 2.3 | Replacement of Damaged Landscape Features..... | 5 |
| 2.4 | Temporary Construction | 6 |
| 2.5 | Stream Crossings..... | 6 |
| 2.6 | Fish and Wildlife Resources | 6 |
| 2.7 | Wetland Areas | 6 |
| 2.8 | Drinking Water and Groundwater Resources | 6 |
| 3.0 | Protection of Historical and Archaeological Resources | 7 |
| 3.1 | Objectives..... | 7 |
| 3.2 | Methods..... | 7 |
| 4.0 | Storm Water Management and Control..... | 8 |
| 4.1 | Ground Cover..... | 8 |
| 4.2 | Erodible Soil..... | 8 |
| 4.3 | Temporary Measures..... | 8 |
| 4.4 | Best Management Practices | 9 |
| 4.4.1 | Effective Selection, Implementation, and Maintenance of Best Management Practices..... | 9 |
| 4.4.2 | Contractor’s Inspection of BMPs..... | 10 |
| 5.0 | Protection of the Environment from Waste Derived from Contractor Operations .. | 12 |
| 5.1 | Control and Disposal of Solid and Sanitary Waste | 12 |
| 5.2 | Control and Disposal of Hazardous Waste | 13 |
| 5.2.1 | Off-Island Disposal of Hazardous Waste..... | 15 |

| | | |
|-------------|---------------------------------------------------------------|-----------|
| 5.2.2 | On-Island or Off-Island Disposal of Non-Hazardous Waste | 15 |
| 6.0 | Prevention of Releases to the Environment..... | 17 |
| 6.1 | Procedures to Prevent Releases to the Environment..... | 17 |
| 6.2 | Precautionary Measures to Prevent Spills..... | 17 |
| | Secondary Containment | 17 |
| | Control of Hazardous Energy | 18 |
| 6.3 | Spill Diversion and Containment Measures..... | 18 |
| 6.4 | Sources of Spills..... | 18 |
| 6.5 | Pollution-Specific Response Procedures in Case of Spill..... | 20 |
| | Liquid Spills and Releases to the Environment | 20 |
| | Solids Spills and Releases to the Environment..... | 21 |
| 6.6 | Spill Response Equipment, Materials, and Supplies..... | 21 |
| 6.7 | Locations and Inspection Requirement of Response Kits..... | 22 |
| 6.8 | Spill Response and Notifications | 22 |
| 7.0 | Regulatory Notification and Permits | 25 |
| 8.0 | Clean Air Act Compliance | 26 |
| 9.0 | Dirt and Dust Control..... | 27 |
| 9.1 | Facility External Layout..... | 27 |
| 9.2 | Sources of Dust and Dirt | 27 |
| 9.2.1 | Vehicles..... | 27 |
| 9.2.2 | Heavy Equipment..... | 27 |
| 9.3 | Mitigation Methods | 27 |
| 10.0 | References..... | 28 |

LIST OF TABLES

| | |
|---------|------------------------------------------------|
| Table 1 | ██████████ Red Hill Emergency Action Committee |
| Table 2 | Emergency Contacts |
| Table 3 | Spill Severity Matrix |

LIST OF FIGURES

| | |
|----------|--------------------------------|
| Figure 1 | Site Location and Laydown Area |
|----------|--------------------------------|

LIST OF ATTACHMENTS

| | |
|--------------|--------------------------------------------|
| Attachment 1 | Environmental Managers Designation Letters |
| Attachment 2 | Training Certifications |
| Attachment 3 | Spill Kit Inspection Form |
| Attachment 4 | ██████████ Red Hill Contingency Plan |

Procurement sensitive and proprietary information – This information is exempt from disclosure under 5. U.S.C. § 552(b)(4) because it contains proprietary and procurement sensitive information.

ACRONYMS AND ABBREVIATIONS



CFR
DOT
EPP
FOR
HDOH
HSE
HW
JBPHH
NAVFAC
NTR
SSHO



Code of Federal Regulations
Department of Transportation
Environmental Protection Plan
Fuel Oil Reclamation
Hawaii Department of Health
Health, Safety, and the Environment
Hazardous Waste
Joint Base Pearl Harbor-Hickam
Naval Facilities Engineering and Expeditionary Warfare Center
Navy Technical Representative
Site Safety and Health Officer

Distribution authorized to U.S. Government Agencies only;
Other requests shall be referred to NAVFAC HI.



1.0 GENERAL OVERVIEW

1.1 General Overview and Purpose

This Environmental Protection Plan (EPP) details the work activities to be completed by [REDACTED] to mitigate adverse environmental impacts and ensure work complies with all applicable environmental regulations for the tank cleaning work at Red Hill Underground Fuel Storage Complex, Joint Base Pearl Harbor-Hickam (JBPHH), Hawaii. All work will be conducted in accordance with the Statements of Work entitled “Clean Fuel Storage Tanks for Closure, Joint Base Pearl Harbor-Hickam, Hawaii,” received 23 May 2023. [REDACTED] will perform this work under contract number [REDACTED].

It is assumed that all tanks to be cleaned will be drained and emptied of recoverable, flowable fuel when turned over to [REDACTED] at the project start date. All associated pipelines are expected to be drained and emptied. No residual fuel is expected to be encountered.

The elements of this plan will coincide with the Installation Hazardous Waste Management Plan when within the installation.

1.2 Separate Plans

Specific plans required by the contract and prepared separately consist of the following:

- **Waste Management Plan:** Ensures that all waste generated during tank cleaning and closure activities will be managed in compliance with federal, state, and local government standards.
- **Dirt and Dust Control Plan:** Describes what practices will be employed to keep dirt and dust down.

1.3 Environmental Manager Personnel

The Environmental Managers for this project will be [REDACTED]. They will have the authority to implement applicable environmental regulations, responsible to document environmental procedures, direct spill response, and ensure training is provided to project personnel on all aspects of this EPP as required by the contract. The Quality Control Manager, Construction Manager, and Site Safety and Health Officer (SSHO) will also have the authority to stop any work in violation of this EPP.

A letter signed by an officer of the firm appointing the Environmental Managers is included as Attachment 1 of this EPP. This letter designates the persons responsible for managing and implementing the environmental program as described in the project contract.

All required training as designated by contract shall be obtained prior to project commencement and updated or recertified prior to qualification expiration dates or as mandated per contract requirements.

Procurement sensitive and proprietary information – This information is exempt from disclosure under 5. U.S.C. § 552(b)(4) because it contains proprietary and procurement sensitive information.

PII – This information is exempt from disclosure under 5 U.S.C. § 552(b)(6), which protects personally identifiable information.

1.4 Operating Procedures

The [REDACTED] consists of over 1,400 documents of which approximately 465 documents are related to Health, Safety, and the Environment (HSE). These documents include forms, guidelines, checklists, policies, and procedures. Specific [REDACTED] documents applicable for this EPP are:

- [REDACTED]
- [REDACTED]
- [REDACTED]

1.4.1 Contingency Plan

The [REDACTED] Red Hill Team developed the site-specific Contingency Plan to act as the actionable preparedness plan in response to emergency situations that have the potential to harm the environment, personnel, or the facility and project equipment. The Contingency Plan identifies responsible persons, actions, and equipment or resources available to prevent incidents, contain spills, or react to fires and explosions.

The Contingency Plan establishes the Emergency Action Committee, onsite personnel's roles and responsibilities to assume during an emergency situation at the project site. A copy of the site-specific Contingency Plan in full detail is maintained onsite. The positions are provided in Table 1. The plan is provided with this document as Attachment 4.

[REDACTED] RED HILL EMERGENCY ACTION COMMITTEE

| Position | Primary | Alternate |
|-----------------------------------------------|------------|------------|
| Emergency Coordinator (Incident Commander) | [REDACTED] | [REDACTED] |
| Evacuation Coordinator | [REDACTED] | [REDACTED] |
| Communication Coordinator | [REDACTED] | [REDACTED] |
| Emergency Supplies Coordinator | [REDACTED] | [REDACTED] |

1.5 Communication and Training

The HSE Manager and Deputy Project Manager will complete the on-line Environmental Compliance Assessment Training and Tracking System training prior to construction. Spill response, environmental protection, and compliance training will be documented for [REDACTED] and subcontractor personnel upon completion. In-house training will be conducted to familiarize

Procurement sensitive and proprietary information – This information is exempt from disclosure under 5. U.S.C. § 552(b)(4) because it contains proprietary and procurement sensitive information.

PII – This information is exempt from disclosure under 5 U.S.C. § 552(b)(6), which protects personally identifiable information.

employees of the requirements following [REDACTED] procedures and contract specifications. Training topics will include, but are not limited to the following:

- Spill reporting and response procedures
- Waste stream identification, collection, segregation, and labeling
- Hazardous material storage and use

Environmental training certifications are presented in Attachment 2 of this document.

TABLE 2: EMERGENCY CONTACTS

| Position | Name | Phone Number | Email |
|------------------------|------------|--------------|------------|
| Project Manager | [REDACTED] | [REDACTED] | [REDACTED] |
| Deputy Project Manager | [REDACTED] | [REDACTED] | [REDACTED] |
| Site Superintendent | [REDACTED] | [REDACTED] | [REDACTED] |
| Construction Manager | [REDACTED] | [REDACTED] | [REDACTED] |
| QC Manager | [REDACTED] | [REDACTED] | [REDACTED] |
| HSE Manager | [REDACTED] | [REDACTED] | [REDACTED] |
| SSHO | [REDACTED] | [REDACTED] | [REDACTED] |

1.6 General Site Information

The mined-in-place, underground, cylindrical petroleum storage tanks are located at the Red Hill Underground Fuel Storage Complex at JBPHH, Oahu, Hawaii. Each tank is capable of holding approximately 12.5 million gallons of fuel. The tanks provide storage for two different types of jet fuel; JP-5 and F-24, and diesel fuel, F-76. The tank tops and bottoms are domed at each end. Access into the tanks is provided by an upper access catwalk system approximately 190 feet above the tank bottom, and a lower access tunnel just below the tank bottom.

A general site location and laydown plan can be found in Figure 1 below.

DCRIT determination for RH – This information is exempt from disclosure under 5 U.S.C. § 552(b)(3) because it meets the requirements for exemption under 10 U.S.C. § 130e.

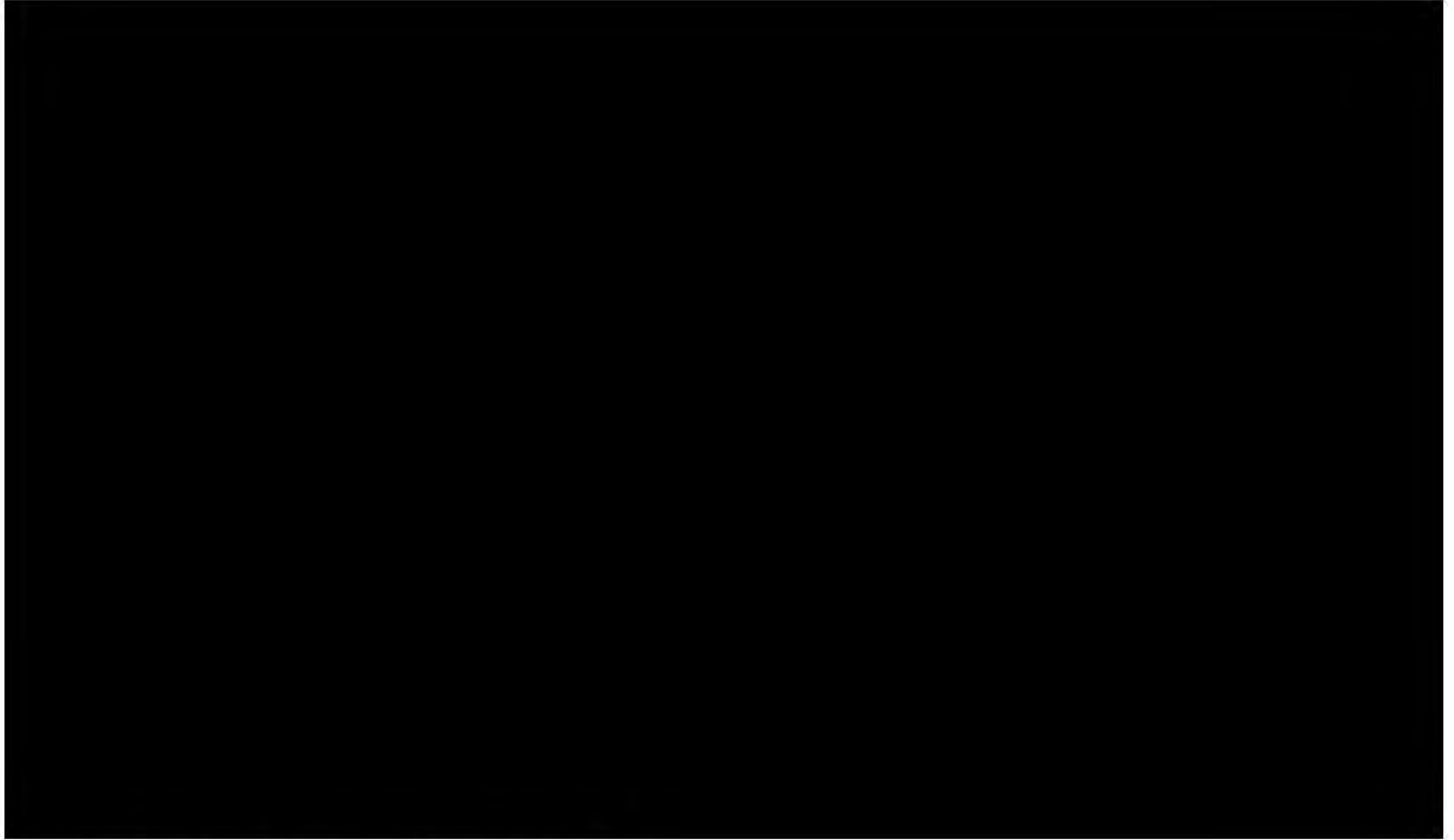

FIGURE 1: SITE LOCATION AND LAYDOWN AREA

Distribution authorized to U.S. Government Agencies only;
Other requests shall be referred to NAVFAC HI.

2.0 MANAGEMENT OF NATURAL RESOURCES

2.1 Land Resources

All project work will be performed in, or immediately adjacent to, improved areas. No work is anticipated for unimproved areas or areas of native vegetation. Except for designated work areas, the sites will be preserved in, or restored to, their original condition. Temporary equipment and material storage areas will be identified and approved by the Navy Technical Representative (NTR). Any removal and excavation activities will be conducted in a manner that minimizes impact and protects the surrounding areas from being disturbed. Precautions to be taken to minimize impact will include, but are not limited to, the following:

- All heavy equipment and vehicle operations will be limited to designated roadways and predetermined routes.
- Debris from work activities will be collected daily.
- Proper guidance will be provided to heavy equipment operators to minimize impact to designated work areas.

2.2 Tree Protection

During construction activities, efforts will be made to minimize the impact to site vegetation (both inside and outside the designated work areas, storage areas, and access routes). Site vegetation consist of trees, bushes, and wild grasses. At the work site location, no endangered or protected trees nor vegetation, are known to exist. Precautions taken to minimize the impact of field activities on the existing vegetation will include:

- Using existing roads only.
- Closely supervising equipment operators and emphasizing preservation of vegetation in non-work areas.
- Providing proper guidance to heavy equipment and truck operators to minimize damage to adjacent vegetation not directly affected by field activities.

2.3 Replacement of Damaged Landscape Features

During construction activities, efforts will be made to minimize the impact to site landscape features (both inside and outside the designated work areas, storage areas, and access routes). Precautions taken to minimize the impact of field activities on the landscape features will include:

- Using existing roads only.
- Closely supervising equipment operators and emphasizing preservation of landscape features in non-work areas.
- Providing proper guidance to heavy equipment and truck operators to minimize damage to adjacent landscape features not directly affected by field activities.

- No unauthorized clearing or digging shall be conducted to minimize damage to landscape features, such as rock formations and established vegetation boundaries that serve to stabilize the mountain side.

2.4 Temporary Construction

Temporary construction activities are expected to be minimal. Effort will be made to minimize the impact of temporary construction and temporary facilities. Only designated areas will be used for temporary facilities and or construction activities. All temporary construction is expected to be removed from the site upon project completion.

Measures to protect natural resources including surface waters and storm water runoff from pollution associated with temporary construction materials are described in sections 4.3 and 4.4. Measures to address potential impacts of material transfer through the tunnel are provided in section 6.0.

2.5 Stream Crossings

Not Applicable. There is no stream crossing located at the project site. The nearest surface water feature is an unnamed concrete lined drainage ditch which runs along the Red Hill facility perimeter fence below the lower extension of Icarus Way. There is a vegetated hillside slope approximately 400 feet wide between the [REDACTED] laydown area near ADIT 4 and this drainage ditch. The ditch connects to Halawa Stream approximately 5000 feet from the point nearest to the project site, near the H-3 interchange.

2.6 Fish and Wildlife Resources

All phases of construction activities will be performed in a manner that protects fish and wildlife. Impacts to some surrounding areas may not be considered a significant concern since all work is underground. No fish or wildlife habitats are expected to be impacted in anyway.

2.7 Wetland Areas

Due to the location of work within stone/concrete tunnels, no wetlands are expected to be impacted.

2.8 Drinking Water and Groundwater Resources

The Red Hill facility is located above a freshwater aquifer. Due to the close proximity of the construction sites and interior facility layout, it is possible that any spills or releases of hazardous materials such as fuel can enter the groundwater aquifer. All project activities involving the handling, storage, or movement of possible contaminants shall be conducted involving containment, barriers, and response equipment readily available.

3.0 PROTECTION OF HISTORICAL AND ARCHAEOLOGICAL RESOURCES

3.1 Objectives

All phases of construction activities will be performed in a manner consistent with the Navy approved [REDACTED] Red Hill tank cleaning work plan and the tank cleaning section to be approved by DOH and EPA as part of the RHBFSF closure plan.

3.2 Methods

Any actions with the potential to impact the historic Red Hill facility will be subject to Navy review prior to approval. [REDACTED] will verify that any intrusive activities are reviewed and approved in advance by JBPHH, in order to ensure no historic or archaeological resources are impacted.

4.0 STORM WATER MANAGEMENT AND CONTROL

4.1 Ground Cover

Ground cover in the work area is not expected to be impacted as it is within stone/concrete tunnels. Furthermore, the temporary facilities placed outside the tunnels will have minimal impact to ground cover, and the site will be restored to original condition after demobilization.

4.2 Erodible Soil

Soil erosion in the work area is not expected to be impacted as it is within stone/concrete tunnels. Temporary measures to mitigate loss of erodible soil at the temporary facility outside the tunnels are not expected. However, if required, those measures will be maintained throughout the project.

4.3 Temporary Measures

The majority of work will be conducted inside the Red Hill facility, in areas not exposed to storm water. Activities which may occur at the laydown area near ADIT 4 include material storage and handling, vehicle parking, and temporary waste storage. Due to the limited nature of activities with potential for stormwater exposure, installation of structural BMPs is not expected to be required. Existing vegetated areas will remain undisturbed and no activities would occur on sloped areas which could contribute to erosion. Therefore, stabilization measures are not anticipated at this time.

Temporary measures to prevent pollution and discharge of non-storm water runoff will include:

- All containers of hazardous materials will be stored under cover to minimize exposure to storm water and in secondary containment to prevent spills, leaks, or drips which could be exposed to storm water.
 - Hazardous material storage areas will be inspected on a weekly basis to ensure containers remain in good condition, and secondary containment remains intact.
 - Spill kits will be maintained in areas where hazardous materials may be stored
 - Quantities of hazardous materials stored on site will be limited to only the amount necessary for work.
 - All hazardous material will be stored in appropriate containers in properly designated hazardous material storage cabinets.
- Storage of materials which could contribute pollutants to storm water runoff such as grease, rust, or flaking paint will be in covered areas as much as possible. Material stored in areas exposed to storm water will be inspected weekly and, if needed, placed on impermeable containment berms
- Vehicles on site will be inspected weekly for leaks or spills, and any leaking vehicles or equipment will be protected by drip pans until the equipment can be taken off-site for maintenance.

- Waste generated will be taken off-site as directly as possible to minimize the amount of time waste is stored in areas exposed to storm water.
 - Waste storage areas will be bermed in an impermeable containment area to contain potential leaks or spills, and managed to prevent windblown trash.
 - During waste handling activities, trucks that enter the site for waste disposal will be inspected to ensure no leaks, spills or other potential sources of pollutants.
- Prevent the erosion of soil from around the temporary storage area by limiting vehicle movement to paved areas as much as possible.

If temporary waste storage facilities are needed outside the tunnels, then surface water runoff will be managed in order to complete the following:

- Contain the waste in an impermeable plastic-lined berm so no water enters or leaves the containment area.
- Prevent the erosion of soil from around the temporary storage area.

4.4 Best Management Practices

██████████ will follow the below processes for BMP selection, implementation, maintenance, and inspection

4.4.1 Effective Selection, Implementation, and Maintenance of Best Management Practices

The HSEM and Environmental Managers will select and implement BMPs that suit the requirements for activities being conducted at the site. BMPs will include, but are not limited to the following:

4.4.1.1 Good Housekeeping

- Sites will maintain good housekeeping to reduce the potential for stormwater to come in contact with materials, waste and debris on site.
- Sites will store materials, chemicals, and wastes as described in Section 4.3 above.
- Sites will clean-up work areas and paved storage areas on a regular basis.
- Sites will properly dispose of waste materials as soon as practicable.

4.4.1.2 Equipment and Machinery Maintenance

- Sites will maintain equipment and machinery in accordance with the manufacturer's recommendations and or instruction manuals.
- Sites will have equipment and machinery user manuals on site or readily available for reference.
- Sites will maintain records of equipment and machinery maintenance onsite.

4.4.1.3 Exposure Minimization

- Waste and recyclables containers will be covered when not in use.

Distribution authorized to U.S. Government Agencies only;
Other requests shall be referred to NAVFAC HI.

- Materials and equipment will not be stored near stormwater conveyance systems without the implementation of appropriate BMPs to mitigate any potential exposure to stormwater conveyance systems.
- Metal parts and components will be stored off the ground where possible, by utilizing any of the following or other effective means:
 - Pipe Racks
 - Pallets
 - Wooden posts
- Project/site waste materials will be stored off the native ground surface and covered where possible. Wastes with potential to release liquids or contaminated rain run-off will be stored in secondary containment. Acceptable means include
 - Concrete or paved surfaces
 - Covered heavy plastic liner
 - Portable secondary containment units
 - Roll-off containers and dumpsters

4.4.1.4 Management of Stormwater Runoff

The site will utilize physical structures to divert runoff away from potential pollutant sources and areas prone to erosion. Stormwater runoff management structures include but are not limited to:

- Roof drain down-spouts where appropriate to divert roof run-off away from areas with potential pollutants
- Material with potential to leach contaminants to groundwater will be kept out of the elements or covered.
- Storage areas of material shall not be in locations prone to erosion or increase the potential for erosion.

BMP implementation will be scheduled to precede the site activities for which the BMPs are selected. The HSEM or Environmental Managers will be responsible for managing the BMP installation schedule to ensure completion of BMP installation in a timely manner as needed.

4.4.2 Contractor's Inspection of BMPs

The HSEM or their designee will conduct inspections daily when applicable and maintain the BMPs. BMP inspections will include:

- Visual inspection of the BMPs implemented at the site
- Documentation of the effectiveness of the BMPs at the site
- Documentation of any repairs or maintenance that may be required

Procurement sensitive and proprietary information – This information is exempt from disclosure under 5. U.S.C. § 552(b)(4) because it contains proprietary and procurement sensitive information.

The HSEM or their designee will document BMP inspections and the corrective actions taken by site personnel to improve the effectiveness of the BMPs. The HSEM or their designee will maintain BMP inspections within the site files.

Distribution authorized to U.S. Government Agencies only;
Other requests shall be referred to NAVFAC HI.

5.0 PROTECTION OF THE ENVIRONMENT FROM WASTE DERIVED FROM CONTRACTOR OPERATIONS

5.1 Control and Disposal of Solid and Sanitary Waste

All relevant federal, state, and local rules and regulations regarding the transport, storage, use, documentation, transportation, and disposal of waste shall be followed. Waste shall be properly packaged using Department of Transportation (DOT) containers that are compatible with the waste being stored. Containers shall be labeled to identify its contents. Keep wastes segregated and place in separate containers. Do not combine or consolidate waste generated from different processes. Containers of liquid must be stored on adequate secondary spill containment. Locate spill containment under shelter where feasible or ensure that spill containment is emptied after rain events. Rain water shall be collected in appropriate containers and treated as if it contains contaminants. Following a sample analysis, the rain water will be disposed of per regulatory guidance. When applicable or possible, a waste determination shall be made prior to the generation of a waste stream to determine whether the waste is hazardous or non-hazardous. The following non-hazardous solid and sanitary wastes are anticipated:

- Sanitary wastes generated from temporary self-contained portable toilets will be removed from the site on a regular basis.
- Residual fuel, sludge, sediment, or deleterious material generated by the tank cleaning process will be collected in 55-gallon drums, following a sample analysis. Drums will be removed from the tank via upper access tunnel. Within secondary containment, drums will be staged in an adjacent alcove. Transportation will be arranged at intervals necessary to minimize the number of drums within the facility. The typical transport truck supplied to transfer drummed waste off-site can hold 30-40 drums. This quantity should serve as the maximum stored on site at one time allowing for the regular removal of waste from the job site. The movement of drums from one point to another within the installation will be minimalized to mitigate the potential of mishaps during travel.
- Rinse water generated by the tank cleaning process will be flowed through the facility fuel oil reclamation (FOR) 4-inch pipeline to the S-311 above ground storage tank located outside of the Adit 3 entrance. The waste will be sampled, analyzed, and disposed of in accordance with federal, state, and local regulations.
- Soiled personal protective equipment will be collected daily during the project timeline. It is estimated that two, 55-gallon drums per tank will be accumulated.

Rinse water will be sampled and tested with the total halogen test and a field screen test to determine if the waste is considered hazardous or non-hazardous. If the water is considered to be nonhazardous, it shall be packaged, labeled, stored, transported, treated, and disposed of in accordance with Title 40 Code of Federal Regulations (CFR) Parts 260-266. If water is found to be hazardous, it will be disposed of accordingly per federal, state, and local regulations.

The sludge is to be tested using the total petroleum hydrocarbons-diesel range, Toxicity Characteristic Leaching Procedure 8 Resource Conservation and Recovery Act metals, volatile

organic compounds, and flash point tests. Once the sludge has passed all tests and been determined to be nonhazardous, it will be disposed of in a sanitary landfill.

For waste requiring a laboratory analysis prior to disposal, environmental testing services must be accredited by a nationally recognized and/or DoD recognized laboratory accreditation body (e.g., National Environmental Laboratory Accreditation Program - NELAP, Department of Defense Environmental Laboratory Accreditation Program - DoD ELAP) for the applicable matrix (e.g. solid, water, etc.), test method (e.g. EPA 1311, 6010, 7471, 8082, etc.) and analyte (e.g. lead, cadmium, chromium, mercury, polychlorinated biphenyls, etc.) to be tested.

NOTE: The plan required by Section 01 74 19, Construction Waste Management and Disposal, is the Waste Management Plan.

5.2 Control and Disposal of Hazardous Waste

All relevant federal, state, and local rules and regulations regarding the transport, storage, use, and disposal of hazardous materials will be followed. [REDACTED] will document the quantity and types of hazardous wastes that are stored onsite, together with the storage, handling, and disposal procedures.

If over 55 gallons of HW, 1 quart of liquid acute HW, or 2.2 lbs of solid acute HW is expected, [REDACTED] shall take appropriate, timely actions (such as scheduling and expediting waste pickup and HW manifest preparation and review) prior to generating waste. Waste in excess of 55 gallons of HW, 1 quart of liquid acute HW, or 2.2 lbs of solid acute HW will not be generated until a waste pickup date is scheduled that will comply with the 3-day regulatory limit. [REDACTED] will provide manifest/waste documentation for Government review at least 10 working days prior to scheduled pickup date.

[REDACTED] will be required to establish a less than 90-day accumulation site for wastes expected to be characterized as HW only if the HW in excess of 55 gallons (or 1 quart of liquid acute HW or 2.2 lbs of solid acute HW) cannot be removed from the site within 3 calendar days despite all reasonable pre-planning efforts.

Approval by the contracting officer is required prior to establishing a 90-day accumulation site. At least 10 working days prior to accumulating waste, submit a request in writing to the Contracting Officer and provide the following information: Contract Number; Contractor; Hazardous Waste or Regulated Waste POC; Phone Number; Type of Waste; Source of Waste; Emergency POC; Phone Number; Location of the Site; Site Plan.”

For less than 90-day accumulation sites, 40 CFR 260-268 requirements shall be met which include, but are not limited to: Personnel Training, Weekly Inspections, Contingency Plan, Arrangements with Local Authorities, and Access to Communications or Alarm System. These requirements shall be in place prior to using a less than 90-day accumulation site. Requirements for a less than 90-day accumulation site are significantly more stringent and labor intensive than for a satellite accumulation area. Planning ahead by preparing disposal paperwork and contacting waste transporters can minimize the need for a less than 90-day accumulation site.”

Hazardous wastes will be handled as follows:

1. HW shall be properly packaged using DOT containers that are compatible with the waste being stored. Keep wastes segregated and place in separate containers. Do not combine or consolidate waste generated from different processes.
2. Containers of liquid must be stored on adequate secondary spill containment and under shelter when possible. When uncovered, secondary containment used must be capable of containing 10 percent of the volume of all containers or the entire volume of the largest container, plus sufficient freeboard for rainwater accumulations.
3. Each HW container shall have a label with the words, “Hazardous Waste,” a description of the contents, and an emergency point-of-contact and phone number.
4. HW containers shall be closed except when adding or removing waste. Storage of HW must be at or near the point of generation and under the control of the point-of-contact specified on the drum.
5. Once 55 gallons of HW is exceeded, the HW in excess of 55 gallons must be removed within 3 calendar days and the drum(s) must be marked with the accumulation start date.
6. Submit waste documentation (lab analyses, waste profile, clearance request, waste documentation certification, etc.) to the Contracting Officer at least ten working days prior to the scheduled waste pick up to allow for adequate environmental department review.
7. Waste will be collected from the underground tank interior, drummed and stored at the point of accumulation, and transported to the proper facility for disposal.
8. Any potential Resource Conservation and Recovery Act hazardous waste generated will be tested to verify its proper waste characterization.
9. Sampling and analysis will be handled in accordance with all applicable environmental regulations.
10. [REDACTED] will notify the NTR upon generation of any hazardous waste and request the JBPHH hazardous waste generator identification and the name of the person authorized to sign hazardous waste manifests. A DOT-permitted transporter will be subcontracted to transport and broker disposal of the hazardous waste at a permitted disposal facility acceptable to JBPHH’s appropriate environmental point of contact.
11. All disposal of hazardous waste will be in compliance with Land Disposal Restrictions Title 40 CFR Part 268. The JBPHH-authorized person will need to certify the land disposal restriction documents and waste profiles as part of the U.S. mainland waste facilities acceptance.
12. Copies of manifests or hazardous materials shipping documents along with acceptance documentation from the permitted recycling facility will be obtained and submitted with project close-out documents.

Distribution authorized to U.S. Government Agencies only;
Other requests shall be referred to NAVFAC HI.

13. Used oils will be recycled as far as practicable and be segregated from domestic-type solid wastes for recovery/recycling. All procedures shall be in accordance with Title 40 CFR Part 279.
14. [REDACTED] will take all measures possible to minimize hazardous waste generation through recycling at state of Hawaii-approved recycling centers versus disposing of hazardous materials such as lead-acid batteries and used oil or similar.
15. As indicated above, the proposed permitted U.S. mainland facility will need to be approved by the appropriate environmental contact at JBPHH. The facility-signed manifest and certificate of disposal will be returned to the person from JBPHH, who certified that particular hazardous waste manifest.
16. The removal of any hazardous waste will be performed by subcontractors that will have current Hazardous Waste Operations and Emergency Response training certificates. All waste to be transported off base shall have an EPA Identification Number. Any [REDACTED] employee handling hazardous waste will also be similarly trained.

Facilities or subcontractors offering construction waste transport on-site or off-site must ensure that proper shipping orders, bill of lading, manifests, or other shipping documents containing waste diversion information meet requirements of 40 CFR 273 Universal Waste Management, 49 CFR 173 Shippers - General Requirements for Shipments and Packagings, and 49 CFR 178 Specifications for Packaging. Individuals signing manifests or other shipping documents should meet the minimum training requirements.

5.2.1 Off-Island Disposal of Hazardous Waste

Hazardous waste disposal shall be performed at a permitted off-island treatment, storage, and disposal facility. Before transporting hazardous waste off government property, a hazardous waste manifest, land disposal restriction (LDR) form as applicable, laboratory results, lab accreditation package, Waste Documentation Form, Additional Information for Construction and Demolition Form, and Review Sheet for Waste Characterization and Disposal Form to the Installation Environmental Office via the Contracting Officer. Allow 10 working days for government review. The Installation Environmental Office will sign the hazardous waste manifest as the generator. Contractor transporting hazardous waste off Government property must have transporter EPA Identification Number, appropriate DOT training, and appropriate driver's license endorsements required to transport hazardous waste.

5.2.2 On-Island or Off-Island Disposal of Non-Hazardous Waste

Before transporting any non-hazardous construction and/or demolition debris and waste off Government Property, [REDACTED] will submit the waste documentation package including laboratory results, lab accreditation package, Waste Documentation Form, Additional Information for Construction and Demolition Waste form, and Review Sheet for Waste Characterization and Disposal to the Installation Environmental Office via the Contracting Officer. [REDACTED] shall comply with Department of Transportation (DOT) regulations and implement applicable DOT requirements (e.g., proper shipping name, packaging, marking, labeling, placarding, Commercial

Procurement sensitive and proprietary information – This information is exempt from disclosure under 5. U.S.C. § 552(b)(4) because it contains proprietary and procurement sensitive information.

Driver License with Hazardous Material endorsement, and non-hazardous waste manifest). Prepare the required shipping papers in accordance with DOT regulations, to include proper certification statement required by 49 CFR 172.204(a), and submit to the Installation Environmental Office via Contracting Officer. Allow 10 working days for Government review. Once Government comments are adequately addressed, Installation Environmental Office staff will sign the appropriate waste documentation as the Generator/Property Owner. For non-DOT regulated, non-hazardous waste, prepare and sign any additional documentation similar to a non-hazardous waste manifest when required by the waste disposal facility.

Distribution authorized to U.S. Government Agencies only;
Other requests shall be referred to NAVFAC HI.

6.0 PREVENTION OF RELEASES TO THE ENVIRONMENT

6.1 Procedures to Prevent Releases to the Environment

In order to prevent releases to the environment, the HSE manager will ensure all employees are trained in initial release prevention and response training topics, including the following:

- Contents of this EPP and applicable federal, state, and local regulations governing onshore spill prevention and management.
- Precautionary measures to prevent spills.
- Sources of spills, such as equipment failure or malfunction.
- Standard pollution-specific response procedures in case of a spill.
- Equipment, materials, and supplies available for spill clean-up activities.
- Locations and inspection requirements for spill-response kits.

A detailed description of the above procedures is outlined in the sections below.

6.2 Precautionary Measures to Prevent Spills

Secondary Containment

Preventing a release of hazardous material or waste to the environment remains a critical aspect of performing work on the project site. Uncontrollable events such as equipment malfunction or the occurrence of natural events can hinder all efforts to preventing a spill. A solution to preparing for unforeseen catastrophes is the implementation of secondary containment for any sources of potential releases.

Secondary containment shall accompany all aspects of project work involving the storage, use, movement, or disposal of harmful solids and liquids where applicable. Containment is a catchment area around the potential release source capable of capturing all of the contaminants, typically 110% of the largest quantity or container.

Some examples of project material or equipment and the secondary containment that shall accompany found on site include:

- 55-gallon drums of waste set atop of spill pallets or placed in a non-permeable basin with side walls.
- Boom hydraulic oil pump with built in secondary catchment basin.
- Secondary retainment wall around S-311 FOR tank.
- Generator manufactured double-walled tanks
- Drip diverter catchment hung underneath flanges during line breaking procedures.
- Clear poly material wrapped around liquid transfer hose connections to serve as leak detection and spray prevention

Control of Hazardous Energy

The Facility lock out/tag out (LOTO) procedure has been implemented for all contractors working at Red Hill and JBPHH for systems associated with the fuel pipelines. Authorization to conduct any work which falls under a LOTO requires a Work Authorization Form (WAF) to be issued by government authorizing personnel prior to beginning work. Facility and APTIM LOTO procedures shall be followed by all employees and subcontractors. Facility procedure shall take precedence when applicable.

The WAF procedure shall accompany all line-breaking procedures to prevent the spills and releases of hazardous materials such as residual fuel during the project.

6.3 Spill Diversion and Containment Measures

To control the spread of a spill, the project will evaluate the use of diversion barriers to create spill ways to direct the release away from critical infrastructure such as sumps or drains. The project site is designed to flow fuel downgradient. Relatively, the walking surfaces or ground, is sloped downhill.

Preventing or directing the spill to a controlled location will minimize the impact on environmental resources. Absorbent booms or functional dams may be employed to manage the control of accidental spills throughout the upper and lower tunnels, near areas of waste transfer, or near equipment storage areas. To the greatest extent possible, spills should be diverted to relatively impermeable surfaces such as paved or concrete areas and away from soil. Locations of concern requiring immediate diversion actions have been identified as near the drain culvert than runs parallel to the lower Icarus Way access road and ground water monitoring wells located in the lower tunnel. Well heads are barriered by absorbent boom socks and have plugs installed at the openings. Diversion dams and sandbags are currently installed near or on top of well heads. Prior to the cleaning of sumps, or areas near wells heads, [REDACTED] will coordinate with government representatives to ensure they are protected from intrusion. [REDACTED] will perform site inspections throughout the project timeline to identify environmental threats such as areas of potential spills, spill pathways, and risk mitigation measures.

6.4 Sources of Spills

A release to the environment, whether considered big or small, can have severe effects on the environment and natural resource supplies such as fresh water aquifers. The project has identified multiple sources of potential spills to provide awareness of project . A severity level has been applied to each scenario rated 1 to 3, 1 being the most severe, 3 having the least severe of consequences. Sources of spills information is provided in Table 3 below.

TABLE 3: SPILL SEVERITY MATRIX

| Severity | Source | Hazardous Material | Cause of Spill | Precautionary Measure |
|----------|----------------------------------------|---------------------------------------------------------------------|---------------------------------------------------------------------------------------------------------------|-------------------------------------------------------------------------------------------------------------------------------------------------------------------------------------------------------------------|
| 1 | Fuel day tank | Diesel fuel - 500-gal capacity | Equipment Failure - Pressure vent Human Error - Puncture - struck by vehicle - over filled | Tank is of double wall construction, secondary containment is built-in. The tank is set within a leak and drip catchment containment with side walls. Leak detection port connected to outer tank for inspection. |
| 1 | Generator | Diesel fuel - 430-gal capacity Oil - 9.3-gal capacity | Equipment Failure - Engine oil leak - Hole in diesel tank | Sub-base Fuel Cells (double wall). Contains a leak sensor, low fuel level switch, and a secondary containment tank. UL142 listed. |
| 1 | S311 FOR Tank | Tank wash water Residual fuel/water - 42,336-gal capacity | Tank structural failure | Tank is located inside of a walled containment. |
| 1 | FOR pipeline | Residual fuel Tank wash water | Pipeline leak or rupture | FOR piping has been tested by facility for functionality. Walk the line in its entirety prior to use performing visual inspection. Daily visual inspections to be conducted. |
| 2 | Boom hydraulic tank | Hydraulic oil - 30-gal capacity | Equipment failure - Hose rupture - Failed seal within equipment | Hydraulic pump assembly has catchment tub built into system. |
| 2 | Waste accumulation /transport in drums | Fuel sludge - 55-gal capacity | Drum puncture Dropped drum Drum not properly closed Drum overfilled | Movement of drums conducted with 4-wheel dolly only. Spotter to be used to clear initial pathway. All drums being filled or awaiting transport shall be located within containment basin. |

Distribution authorized to U.S. Government Agencies only;
Other requests shall be referred to NAVFAC HI.



| | | | | |
|---|------------------------------------------|-----------------------------------------------|----------------------------------------------------------------------------------------------------|---------------------------------------------------------------------------------------------------------------------------------------------------------------------------------------------------------------------------------------------------------------------|
| 2 | Vacuum truck operations | Tank wash water (oily water) | Equipment failure -Hose leak/rupture -Fill tank leak | Wrap hose connection with clear poly and tape as leak detection and spray catchment. Place hose connections elevated over catchment such as 5-gal bucket. |
| 3 | Line-breaking (lower tunnel fuel piping) | Diesel/Jet Fuel - F-76 - F-24 - JP-5 | Pipeline is not drained fully Residual fuel not expected | Drip diverter catchment hung around pipeline section to be opened with funnel system plumbed into drum. Any high point relatively available are checked for the presence of fuel. Flanges shall only be cracked when opening to facilitate quick closure if needed. |
| 3 | Tank cleaning | Commercial cleaning agent | Spill during transport to job site Spill during transfer to cleaning equipment holding tank | Ensure containers are closed fully during transport onsite. Place containers inside spill containment during transfer of product for use. |

6.5 Pollution-Specific Response Procedures in Case of Spill

Based upon the identification of waste streams and potential sources of hazardous releases to the environment, the expected spill response procedures shall be capable of containing and completing cleanup operations of solid and liquid material. For all spills, the steps detailed in section 6.7 “Spill Response and Notification” below shall be followed.

Liquid Spills and Releases to the Environment

For all liquid spills, if possible, the sources of the spill shall be secured and proper notifications made. Containment of the spill shall start from the outside boundary of the hazardous material, working inward. Absorbent booms or pads can be placed around the spill to prevent further spread.

If the spill area contains drainage systems, block off access to the drain ways to prevent hazardous material from transferring to unknown or distant locations. Outside of the facility, drainage systems such as the stormwater culvert can not be blocked off for the project duration without disturbing natural stormwater flow paths. Inside the facility, drains such as the groundwater management system, aquifer well stations, and sumps can be blocked off during the project timeline. Such barriers and protections installed in and around the facility will continue to remain

Distribution authorized to U.S. Government Agencies only;
Other requests shall be referred to NAVFAC HI.

in place as needed. An evaluation of these areas will be completed routinely throughout the project prior to moving possible contaminants while on the installation.

Using absorbent material (granular, pads, booms) absorb all possible liquid and contain within available non-permeable container or bag until DOT approved container can be supplied. Absorbents should not be fully saturated or contain free flowing liquid for disposal. Collect and contain all residues of the spilled liquid. All spill response waste shall be collected, labeled, stored, and sampled prior to disposal in accordance with local, state, and federal regulations.

If a liquid spill were to occur, the less of a quantity able to spill greatly impacts the potential of spread for the spilled material. Minimizing the on hand, or on site quantity of a hazardous chemical may reduce the negative impact on the environment. It is for this purpose, only the necessary amount of a hazardous liquid to perform the general assigned tasks will be maintained or stored onsite.

Solids Spills and Releases to the Environment

Spills and releases of hazardous material in a solid state would include tank bottom sludge and debris. Spills of this nature shall be reported and handled in the same manner as liquid waste as outlined above and in section 6.7. Solid waste spill response shall also start from the outside boundary, working inward as applicable. Absorbent material may still be used to absorb and contain the contents. In addition, a tool such as a shovel or broom may also be used to collect solids from up off the ground. For loose debris such as rust and dust, minimal dry sweeping shall be conducted to avoid air dispersal and respirable hazards both inside and outside of the facility tunnels.

Collect absorbent and waste material in a non-permeable container until an approved DOT container can be received at the spill location. All waste derived from response activities shall be collected, labeled, stored, sampled, and disposed of aligning with local, state, and federal regulations.

6.6 Spill Response Equipment, Materials, and Supplies

A spill response kit shall contain any applicable tools, equipment, or material necessary for the initial containment and cleanup of a release until additional support can respond to the location. All spill kits at a minimum shall contain the following supplies.

- Absorbent pads (diapers): 1-2 packs of typically 50-100 pads.
- Absorbent booms: sections measuring 5-10 feet long
- Absorbent granular: 25-50 pound bags
- PPE: chemical resistant gloves, goggles, chemical tyvek overall
- Container: 5 gal buckets or similar, spill kit container also available
- Trash bags
- Strong industrial tape, such as duct tape.
- Caution tape
- Broom and dustpan

- Drain cover seals

Other spill response supplies available onsite include items such as rubber tapered plugs, pipe clamps, isolation inflatable plugs, and mechanical blinds. Pneumatic driven diaphragm pumps and hoses are available onsite for the movement of liquid for any response requiring this equipment to advance clean up procedures. Two 1-inch , and one 2-inch pumps remain onsite at all times as well as a few hundred feet of liquid transfer hoses.

The project keeps DOT approved containers onsite to be readily available if needed. Approximately ten or more 55-gal steel open top drums are kept in inventory. Other containers include ten or more 250-gal totes, and approximately five 55-gal poly drums.

6.7 Locations and Inspection Requirement of Response Kits

Spill response kits shall be conspicuously placarded and be located within the vicinity and readily accessible to all sources of spills or releases to the environment. Based upon the identification of sources of potential spills, the following locations have been identified as requiring that a spill kit be readily accessible:

- Generators and supply diesel tank locations
- S311 FOR tank
- Vacuum truck area of use
- Active lower tunnel alcoves
- Active upper tunnel alcoves
- Along the FOR 4” pipeline during transfers to S311 tank
- Travel along with containers from accumulation point, and to disposal transport truck
- Waste accumulation areas
- Any activity where hazardous substances can be exposed to the environment will have an appropriate-sized spill kit near the operation

Spill kits shall be inspected monthly to ensure all required contents remain readily available if needed. Inspectors shall use document inspections using [REDACTED] “Spill Kit Monthly Inspection Form”. Monthly inspections may be conducted by Site Safety Officers, the HSE Manager, or site Environmental Managers. Completed inspection records shall be kept on file at the job site for the duration of the project.

A tamper seal may be placed on spill kits allowing for the alert that a spill kit was opened and that supplies may be diminished. A tamper seal shall not require the use of a tool or sharp object to remove the seal and allow for easy access to the kit if needed. If a seal has been broken, an inspection shall be done immediately and any diminished supplies replaced.

6.8 Spill Response and Notifications

Project personnel will take appropriate measures to avoid spills when draining, purging, and modifying pipes connected to tanks or during any activity with the potential for a hazardous substance release to the environment. Project personnel will use spill-control techniques that may

Distribution authorized to U.S. Government Agencies only;

Other requests shall be referred to NAVFAC HI.

include temporary oil-absorbent booms, and or plastic sheeting overlaid on lumber, to form temporary containment areas.

Mirroring [REDACTED]'s Contingency Plan, in the event of a spill, the following procedures will be initiated:

- Project personnel will stop the source of the spill; deactivate all applicable power sources and/or emergency stop buttons.
- Immediately notify environmental managers, site management and safety personnel, HSE manager, the customers' representatives, or other personnel designated on the EAC Communication and Organizational Structure as provided in the Contingency Plan (Attachment 4). Due to many worksites being underground without cell-service, on scene notifications shall be made in a manner that results in immediate confirmation of receipt such as by phone call or radio, or in person if possible.
- Clear the location of all persons except those trained to deal with the incident.
- Clean up shall be performed by qualified personnel only.
- Absorbents will be placed to clean up all products and prevent further spread of contamination.
- All absorbent materials and fluids must be contained in DOT-approved open-top drums.
- All absorbent materials and fluids must be assumed to be contaminated until demonstrated otherwise.
- Drums shall be clearly marked according to contents, accumulation date, and known or suspected hazard(s). Drums shall be marked "Pending Analysis" until such time as results have been received from the laboratory.
- Drums shall be segregated into a separate, marked holding area.
- Notify appropriate personnel when the spill has been successfully cleaned.
- Notify Waste Coordinator of all waste accumulated to ensure collection, storage, and disposal of all waste is conducted as required.
- Samples of the spill residue and materials used in the spill cleanup must be collected.
- Materials shall be disposed of in accordance with Department of Health and Environmental Protection Agency requirements.
- Copies of the sample analysis and a letter stating the disposition and location of the disposal will be provided to the NTR and the facility.
- Spilled materials, contaminated soils and water, absorbents, and miscellaneous spill related debris require proper handling. [REDACTED] will properly dispose of these materials and any other materials associated with spill containment and cleanup.

Once the spill is under control by [REDACTED]'s Incident Commander, or when adequately possible, notification to first responders (i.e., installation Fire Department, the Installation, Command Duty Officer, Installation Environmental Office, the JBPHH Regional Dispatch Center, and the Contracting Officer) should be made in parallel with spill mitigation actions. To the extent practicable, notification must include date and time spill occurred or was discovered, location, specific substance spilled, spill volume, operation underway when the spill occurred, and response actions taken or planned.

Throughout the project worksites, and at active tank locations, emergency notification signage will be posted. Emergency contacts at a minimum shall include Environmental Managers, Site Superintendent, project management personnel, and emergency response contacts.

7.0 REGULATORY NOTIFICATION AND PERMITS

Throughout the duration of the project, [REDACTED] will evaluate the potential that activities may involve contact with, or disturbance of hazardous material that can significantly impact human health and the environment. Prior to such involvement, or at the time of realization, [REDACTED] will conduct sampling and testing of the potentially hazardous material. All testing shall be conducted in accordance with local, state, and Federal regulations.

Per the Environmental Management Division of the state of Hawaii the following permits shall be obtained if sampling results indicate the hazardous material is present and may be disturbed or become in direct contact with project personnel.

- Asbestos
- Lead

Based upon project scope of work, it is not expected that lead or asbestos containing material will be encountered to fulfill the contract.

8.0 CLEAN AIR ACT COMPLIANCE

In accordance with the Clean Air Act and Hawaii Department of Health (HDOH) Clean Air Branch HAR 11-60.1, [REDACTED] has submitted an air permit application for the operation of diesel generators. With HDOH concurrence, an air permit is required to be obtained for the project duration.

Upon application approval, the permit will be provided to Naval Facilities Engineering and Expeditionary Warfare Center (NAVFAC) Contracting Officer as a submittal, to include the NAVFAC Permit Record of Decision form.

[REDACTED] submitted an additional inquiry to HDOH regarding an air permit in reference to Red Hill tank degassing with air displacement. [REDACTED] has received verbal confirmation from NAVFAC HI that HDOH Clean Air Branch has reached a decision that the degassing of the underground storage tanks does not require an air permit. [REDACTED] is awaiting an official determination notice at the time of this plan submittal.

A letter is being prepared for submittal to the HDOH Clean Air Branch regarding the air permit applicability of the four surge tanks located onboard JBPHH. [REDACTED] is contracted to degas and clean these tanks in conjunction with the 14 Red Hill tanks.

Degassing of the tanks cannot take place until a formal determination has been received by [REDACTED] from the HDOH Clean Air Branch.

9.0 DIRT AND DUST CONTROL

9.1 Facility External Layout

The Red Hill Facility base has a relatively small footprint as an annex of JBPHH. There are two main roads. Icarus Way is a paved, double lane road that allows travel along the lower sections of the site where the main entrance gate is located. Adit 3 and Adit 6 entrances into the facility tunnels, are accessed from the lower roadway. Following a sharp turn, Icarus Way travels to the upper section of the facility that is carved along the rock side of the mountain. Adits 4 and 5 are accessed from the upper access road.

Work associated with the contract is scheduled to be completed within the facility tunnels underground. For this reason, it is not expected that excessive airborne dust and dirt will be generated along installation roadways affecting outdoor air quality standards set forth in the Clean Air Act.

9.2 Sources of Dust and Dirt

9.2.1 Vehicles

Personal vehicles such as cars and trucks will enter the site daily as employees and subcontractors arrive and depart for contract work on workdays. Vehicles will traverse the lower and upper sections of Icarus Way. All personal vehicles will park in designated areas located at the [REDACTED] trailer offices and laydown area. There will be no parking allowed around Adit 5 and Adit 6.

9.2.2 Heavy Equipment

The only mobile heavy equipment machinery expected to be utilized during the project is a telehandler, or telescoping forklift. The machinery is used to pick up and move heavy pieces of material or equipment in support of project needs. The telehandler is a slow moving piece of construction machinery. Speeds with a load are typically around 1 to 2 miles per hour for safety reasons. Without a load, the equipment is still limited to travel speeds around 3 to 5 miles per hour.

9.3 Mitigation Methods

The following methods will be utilized to minimize dirt and dust on the project site:

- All vehicles and equipment will remain on paved roads when approaching the project site.
- [REDACTED] will clean up any dirt and debris build up on the paved roads derived from this project's equipment, vehicles, or project activities.
- Dust will be controlled by wetting down the area around temporary facilities as necessary.
- All dust will be collected by power vacuum or similar systems when necessary. No dry sweeping or use of powered air movers such as compressed air or leaf blowers will be utilized to clear dirt, dust, or debris.

No Excavation is expected during this project.

10.0 REFERENCES

[1] “Clean Fuel Storage Tanks for Closure, Joint Base Pearl Harbor-Hickam, Hawaii,” parts 1 to 6 dated Fiscal Year 2023.

[2] Test Methods for Evaluating Solid Waste, Physical/Chemical Methods, EPA publication SW-846, Third Edition, Final Updates I (1993), II (1995), IIA (1994), IIB (1995), III (1997), IIIA (1999), IIIB (2005), IV (2008), and V (2015).

[3] *United States Code of Federal Regulations*, Title 40 CFR Parts 260-268, and 279.

[4] [REDACTED] Red Hill Contingency Plan.

Procurement sensitive and proprietary information – This information is exempt from disclosure under 5. U.S.C. § 552(b)(4) because it contains proprietary and procurement sensitive information.



ATTACHMENT 2 TRAINING CERTIFICATIONS

Distribution authorized to U.S. Government Agencies only;
Other requests shall be referred to NAVFAC HI.

Environmental Protection Plan – Clean Red Hill Tanks

Procurement sensitive and proprietary information – This information is exempt from disclosure under 5. U.S.C. § 552(b)(4) because it contains proprietary and procurement sensitive information.

PII – This information is exempt from disclosure under 5 U.S.C. § 552(b)(6), which protects personally identifiable information.



ECATTS

Certificate of Accomplishment

[REDACTED]

Has successfully completed the following competencies:

| Course | Credit Hours | S/N | Date |
|--------------------------------------------------------------------|--------------|---------|-------------|
| Air Quality for Contractors: Hawaii | 0.5 | 5100585 | Jul-23-2021 |
| Asbestos for Contractors: Hawaii | 0.5 | 5103043 | Jul-26-2021 |
| Building Construction, Demolition or Renovation | 0.5 | 5103079 | Jul-26-2021 |
| Drinking Water for Contractors: Hawaii | 0.5 | 5105102 | Jul-27-2021 |
| EMS Awareness Level Training: Hickam | 0.5 | 5097531 | Jul-22-2021 |
| EMS Awareness Training: Commander Navy Region Hawaii | 0.5 | 5097537 | Jul-22-2021 |
| Hazardous Materials: Hickam | 0.5 | 5106978 | Jul-28-2021 |
| Hazardous Waste for Contractors: Hawaii | 0.5 | 5107256 | Jul-28-2021 |
| Natural and Cultural Resources for Contractors: Hawaii | 0.5 | 5122304 | Aug-09-2021 |
| Overview of Environmental Compliance for Contractors: Hawaii | 0.5 | 5046729 | Jun-11-2021 |
| PCBs Management: Hickam | 0.5 | 5166723 | Sep-24-2021 |
| Pesticides for Contractors: Hawaii | 0.5 | 5166725 | Sep-24-2021 |
| Petroleum, Oils, and Lubricants Management for Contractors: Hawaii | 0.5 | 5166729 | Sep-24-2021 |
| Pollution Prevention: Hickam | 0.5 | 5166734 | Sep-24-2021 |
| Project Manager | 0.5 | 5097543 | Jul-22-2021 |
| Recycling | 0.5 | 5166737 | Sep-24-2021 |
| Solid Waste for Contractors: Hawaii | 0.5 | 5166741 | Sep-24-2021 |
| Spill Response | 0.5 | 5166769 | Sep-24-2021 |
| Storage Tanks for Contractors: Hawaii | 0.5 | 5171454 | Sep-30-2021 |
| Stormwater for Contractors: Hawaii | 0.5 | 5171466 | Sep-30-2021 |
| Waste Management Guidelines | 0.5 | 5173483 | Oct-01-2021 |
| Wastewater for Contractors: Hawaii | 0.5 | 5173522 | Oct-01-2021 |
| Wetlands for Contractors: Hawaii | 0.5 | 5173525 | Oct-01-2021 |

[REDACTED]

Distribution authorized to U.S. Government Agencies only;
Other requests shall be referred to NAVFAC HI.

Procurement sensitive and proprietary information – This information is exempt from disclosure under 5. U.S.C. § 552(b)(4) because it contains proprietary and procurement sensitive information.

PII – This information is exempt from disclosure under 5 U.S.C. § 552(b)(6), which protects personally identifiable information.

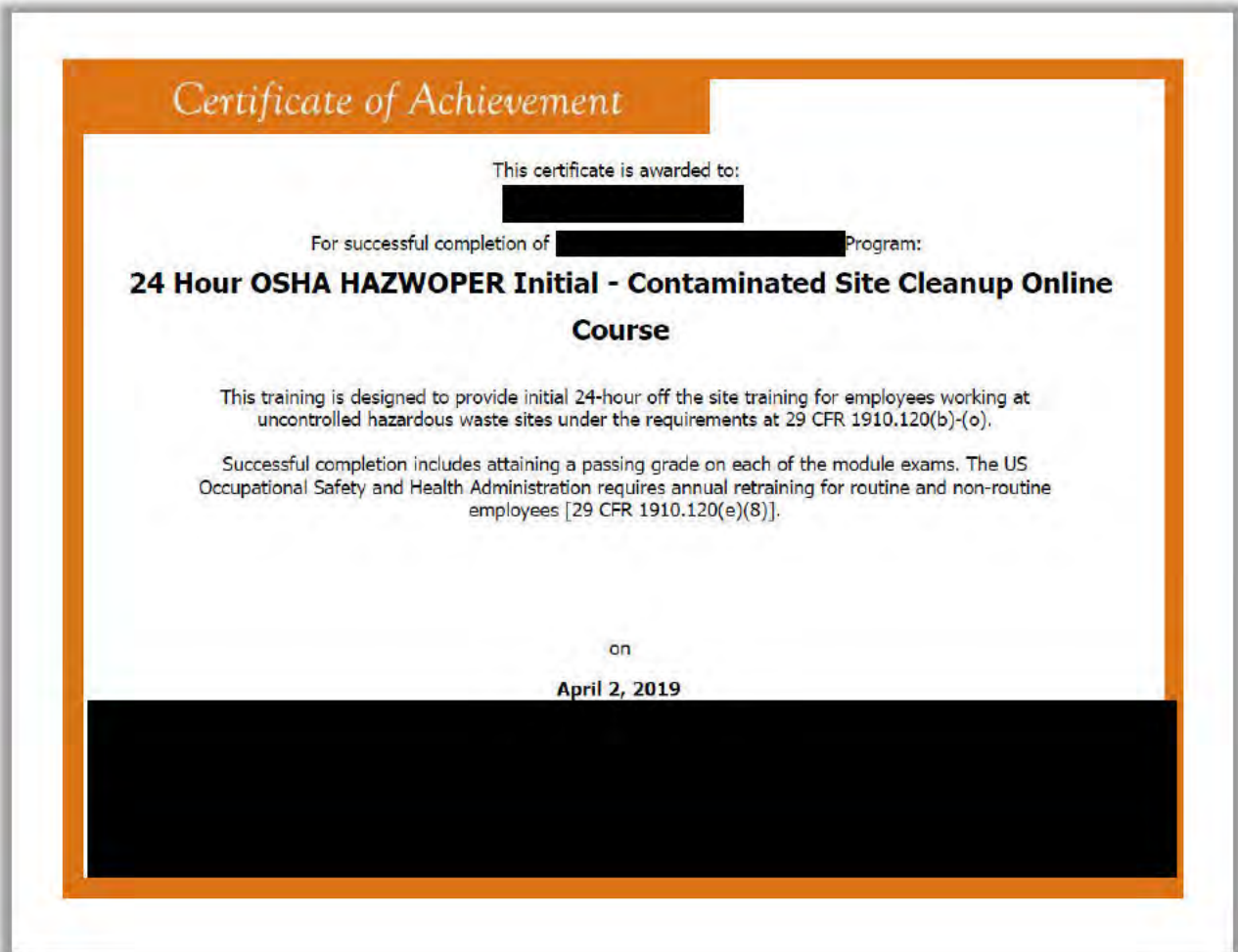

Distribution authorized to U.S. Government Agencies only;
Other requests shall be referred to NAVFAC HI.



Procurement sensitive and proprietary information – This information is exempt from disclosure under 5. U.S.C. § 552(b)(4) because it contains proprietary and procurement sensitive information.

PII – This information is exempt from disclosure under 5 U.S.C. § 552(b)(6), which protects personally identifiable information.



Distribution authorized to U.S. Government Agencies only;
Other requests shall be referred to NAVFAC HI.

Environmental Protection Plan – Clean Red Hill Tanks



Procurement sensitive and proprietary information – This information is exempt from disclosure under 5. U.S.C. § 552(b)(4) because it contains proprietary and procurement sensitive information.

PII – This information is exempt from disclosure under 5 U.S.C. § 552(b)(6), which protects personally identifiable information.



Distribution authorized to U.S. Government Agencies only;
Other requests shall be referred to NAVFAC HI.

Environmental Protection Plan – Clean Red Hill Tanks

[Redacted]

Procurement sensitive and proprietary information – This information is exempt from disclosure under 5. U.S.C. § 552(b)(4) because it contains proprietary and procurement sensitive information.

PII – This information is exempt from disclosure under 5 U.S.C. § 552(b)(6), which protects personally identifiable information.





Distribution authorized to U.S. Government Agencies only;
Other requests shall be referred to NAVFAC HI.

Environmental Protection Plan – Clean Red Hill Tanks



Procurement sensitive and proprietary information – This information is exempt from disclosure under 5. U.S.C. § 552(b)(4) because it contains proprietary and procurement sensitive information.

PII – This information is exempt from disclosure under 5 U.S.C. § 552(b)(6), which protects personally identifiable information.



Environmental Compliance Assessment, Training, and Tracking System

ECATTS

Certificate of Accomplishment

[REDACTED]

Has successfully completed the following competencies:

| Course | Credit Hours | S/N | Date |
|--------------------------------------------------------------------|--------------|---------|-------------|
| Air Quality for Contractors: Hawaii | 0.5 | 3098634 | Jan-11-2017 |
| Asbestos for Contractors: Hawaii | 0.5 | 3098640 | Jan-11-2017 |
| Building Construction, Demolition or Renovation | - | 3098643 | Jan-11-2017 |
| Drinking Water for Contractors: Hawaii | 0.5 | 3098651 | Jan-11-2017 |
| EMS Awareness Level Training: Hickam | - | 3098627 | Jan-11-2017 |
| Environmental Management System: Commander Navy Region Hawaii | - | 3098630 | Jan-11-2017 |
| Hazardous Materials: Hickam | - | 3098655 | Jan-11-2017 |
| Hazardous Waste for Contractors: Hawaii | 0.5 | 3098673 | Jan-11-2017 |
| Natural and Cultural Resources for Contractors: Hawaii | 0.5 | 3098682 | Jan-11-2017 |
| Overview of Environmental Compliance for Contractors: Hawaii | 0.5 | 3098621 | Jan-11-2017 |
| PCBs Management: Hickam | - | 3098667 | Jan-11-2017 |
| Pesticides for Contractors: Hawaii | 0.5 | 3098691 | Jan-11-2017 |
| Petroleum, Oils, and Lubricants Management for Contractors: Hawaii | 0.5 | 3098701 | Jan-11-2017 |
| Pollution Prevention: Hickam | - | 3098705 | Jan-11-2017 |
| Project Manager | - | 3098631 | Jan-11-2017 |
| Recycling | 0.5 | 3098708 | Jan-11-2017 |
| Solid Waste for Contractors: Hawaii | 0.5 | 3098713 | Jan-11-2017 |
| Spill Response | 0.5 | 3098716 | Jan-11-2017 |
| Storage Tanks for Contractors: Hawaii | 0.5 | 3098720 | Jan-11-2017 |

Distribution authorized to U.S. Government Agencies only;
Other requests shall be referred to NAVFAC HI.

Procurement sensitive and proprietary information – This information is exempt from disclosure under 5. U.S.C. § 552(b)(4) because it contains proprietary and procurement sensitive information.

PII – This information is exempt from disclosure under 5 U.S.C. § 552(b)(6), which protects personally identifiable information.



ECATTS

Certificate of Accomplishment

[REDACTED]
Has successfully completed the following competencies:

| Course | Credit Hours | SIN | Date |
|--------------------------------------------------------------------|--------------|---------|-------------|
| Air Quality for Contractors: Hawaii | 0.5 | 5693135 | Oct-16-2023 |
| Asbestos for Contractors: Hawaii | 0.5 | 5693896 | Oct-17-2023 |
| Building Construction, Demolition or Renovation | 0.5 | 5693927 | Oct-17-2023 |
| Drinking Water for Contractors: Hawaii | 0.5 | 5693936 | Oct-17-2023 |
| EMS Awareness Level Training: Hickam | 0.5 | 5693132 | Oct-16-2023 |
| EMS Awareness Training: Commander Navy Region Hawaii | 0.5 | 5693133 | Oct-16-2023 |
| Hazardous Materials: Hickam | 0.5 | 5693943 | Oct-17-2023 |
| Hazardous Waste for Contractors: Hawaii | 0.5 | 5693946 | Oct-17-2023 |
| Natural and Cultural Resources for Contractors: Hawaii | 0.5 | 5693950 | Oct-17-2023 |
| Overview of Environmental Compliance for Contractors: Hawaii | 0.5 | 5693131 | Oct-16-2023 |
| PCDs Management: Hickam | 0.5 | 5694004 | Oct-17-2023 |
| Pesticides for Contractors: Hawaii | 0.5 | 5694005 | Oct-17-2023 |
| Petroleum, Oils, and Lubricants Management for Contractors: Hawaii | 0.5 | 5694011 | Oct-17-2023 |
| Pollution Prevention: Hickam | 0.5 | 5694012 | Oct-17-2023 |
| Project Manager | 0.5 | 5693134 | Oct-16-2023 |
| Recycling | 0.5 | 5694004 | Oct-17-2023 |
| Solid Waste for Contractors: Hawaii | 0.5 | 5694009 | Oct-17-2023 |
| Spill Response | 0.5 | 5694002 | Oct-17-2023 |
| Storage Tanks for Contractors: Hawaii | 0.5 | 5694044 | Oct-17-2023 |
| Stormwater for Contractors: Hawaii | 0.5 | 5694046 | Oct-17-2023 |
| Waste Management Guidelines | 0.5 | 5694060 | Oct-17-2023 |
| Wastewater for Contractors: Hawaii | 0.5 | 5694062 | Oct-17-2023 |
| Wetlands for Contractors: Hawaii | 0.5 | 5694066 | Oct-17-2023 |



Distribution authorized to U.S. Government Agencies only;
Other requests shall be referred to NAVFAC HI.

Procurement sensitive and proprietary information – This information is exempt from disclosure under 5. U.S.C. § 552(b)(4) because it contains proprietary and procurement sensitive information.

PII – This information is exempt from disclosure under 5 U.S.C. § 552(b)(6), which protects personally identifiable information.

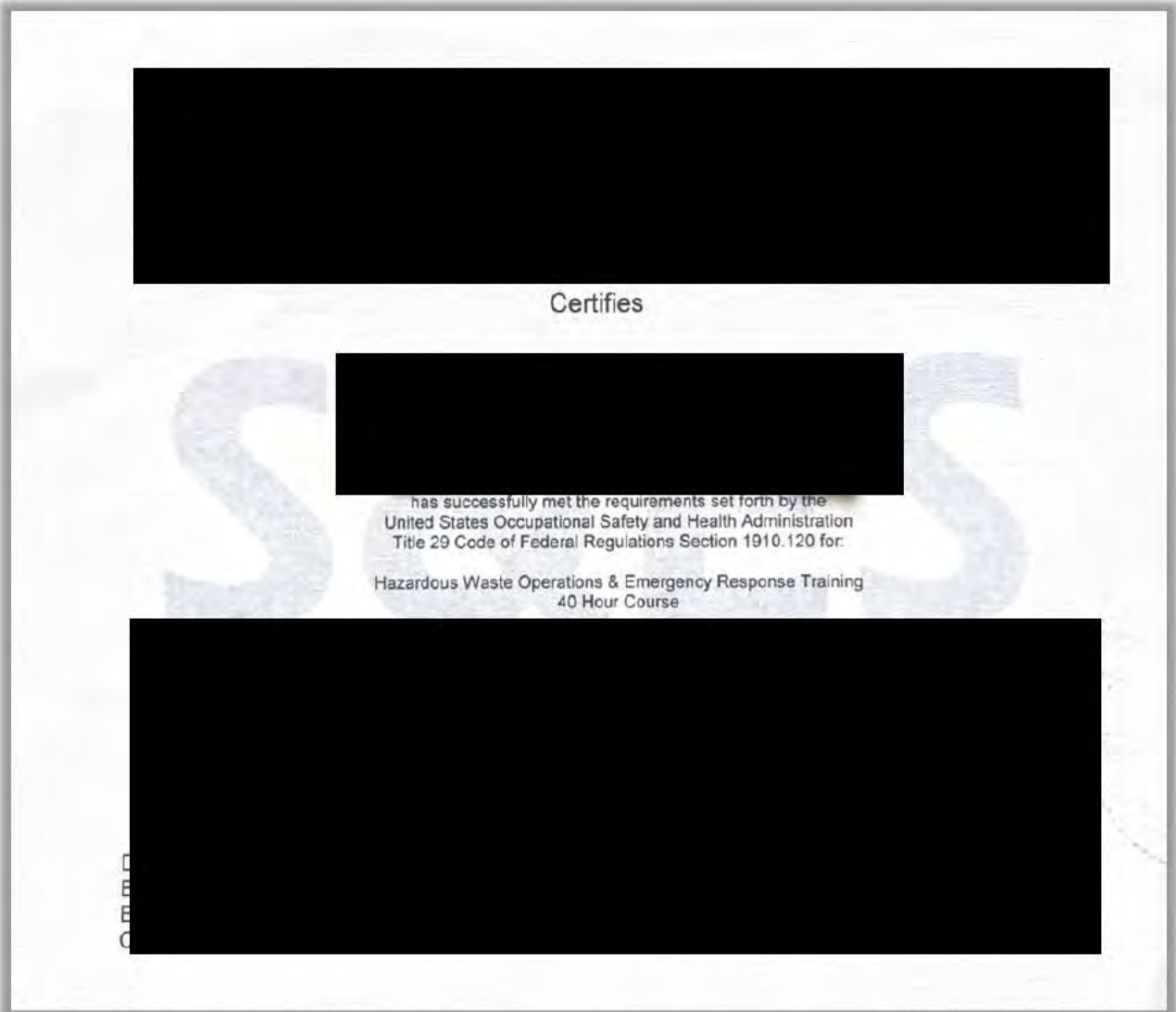

Distribution authorized to U.S. Government Agencies only;
Other requests shall be referred to NAVFAC HI.



Procurement sensitive and proprietary information – This information is exempt from disclosure under 5. U.S.C. § 552(b)(4) because it contains proprietary and procurement sensitive information.

PII – This information is exempt from disclosure under 5 U.S.C. § 552(b)(6), which protects personally identifiable information.







Distribution authorized to U.S. Government Agencies only;
Other requests shall be referred to NAVFAC HI.

Environmental Protection Plan – Clean Red Hill Tanks

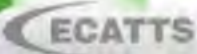

Procurement sensitive and proprietary information – This information is exempt from disclosure under 5. U.S.C. § 552(b)(4) because it contains proprietary and procurement sensitive information.

PII – This information is exempt from disclosure under 5 U.S.C. § 552(b)(6), which protects personally identifiable information.

| | | | | |
|-----------------------------------------------------------------------------------------|---------------|------------------------------------------------------------------------------|-------------|-------------------------------------------------------------------------------------|
|  | | Environmental Compliance Assessment, Training, and Tracking System | |  |
| Environmental Compliance Training System Certificate of Accomplishment | | | | |
|  | | | | |
| Has successfully completed the following environmental competencies: | | | | |
| Course | Credit | S/N | Date | |
| Air Quality for Contractors: Hawaii | 0.5 | 5140516 | Aug-26-2021 | |
| Asbestos for Contractors: Hawaii | 0.5 | 5140541 | Aug-26-2021 | |
| Building Construction, Demolition or Renovation | 0.5 | 5140557 | Aug-26-2021 | |
| Drinking Water for Contractors: Hawaii | 0.5 | 5140570 | Aug-26-2021 | |
| EMS Awareness Level Training: Hickam | 0.5 | 5140509 | Aug-26-2021 | |
| EMS Awareness Training: Commander Navy Region Hawaii | 0.5 | 5140511 | Aug-26-2021 | |
| Hazardous Materials: Hickam | 0.5 | 5140584 | Aug-26-2021 | |
| Hazardous Waste for Contractors: Hawaii | 0.5 | 5140606 | Aug-26-2021 | |
| Natural and Cultural Resources for Contractors: Hawaii | 0.5 | 5140618 | Aug-26-2021 | |
| Overview of Environmental Compliance for Contractors: Hawaii | 0.5 | 5140480 | Aug-26-2021 | |
| PCBs Management: Hickam | 0.5 | 5140622 | Aug-26-2021 | |
| Pesticides for Contractors: Hawaii | 0.5 | 5140635 | Aug-26-2021 | |
| Petroleum, Oils, and Lubricants Management for Contractors: Hawaii | 0.5 | 5140720 | Aug-26-2021 | |
| Pollution Prevention: Hickam | 0.5 | 5140730 | Aug-26-2021 | |
| Project Manager | 0.5 | 5140512 | Aug-26-2021 | |
| Recycling | 0.5 | 5140733 | Aug-26-2021 | |
| Solid Waste for Contractors: Hawaii | 0.5 | 5140744 | Aug-26-2021 | |
| Spill Response | 0.5 | 5140754 | Aug-26-2021 | |
| Storage Tanks for Contractors: Hawaii | 0.5 | 5140881 | Aug-26-2021 | |
| Stormwater for Contractors: Hawaii | 0.5 | 5140717 | Aug-26-2021 | |
| Waste Management Guidelines | 0.5 | 5140700 | Aug-26-2021 | |
| Wastewater for Contractors: Hawaii | 0.5 | 5140669 | Aug-26-2021 | |
| Wetlands for Contractors: Hawaii | 0.5 | 5140651 | Aug-26-2021 | |
|  | | | | |

Distribution authorized to U.S. Government Agencies only;
Other requests shall be referred to NAVFAC HI.

Procurement sensitive and proprietary information – This information is exempt from disclosure under 5. U.S.C. § 552(b)(4) because it contains proprietary and procurement sensitive information.

PII – This information is exempt from disclosure under 5 U.S.C. § 552(b)(6), which protects personally identifiable information.



Distribution authorized to U.S. Government Agencies only;
Other requests shall be referred to NAVFAC HI.



Procurement sensitive and proprietary information – This information is exempt from disclosure under 5. U.S.C. § 552(b)(4) because it contains proprietary and procurement sensitive information.

PII – This information is exempt from disclosure under 5 U.S.C. § 552(b)(6), which protects personally identifiable information.



Distribution authorized to U.S. Government Agencies only;
Other requests shall be referred to NAVFAC HI.

Environmental Protection Plan – Clean Red Hill Tanks



Procurement sensitive and proprietary information – This information is exempt from disclosure under 5. U.S.C. § 552(b)(4) because it contains proprietary and procurement sensitive information.

PII – This information is exempt from disclosure under 5 U.S.C. § 552(b)(6), which protects personally identifiable information.



Environmental Compliance Training System
Certificate of Accomplishment



Has successfully completed the following environmental competencies:

| Course | Credit/S/N Hours | Date |
|--------------------------------------------------------------------|---------------------|-------------|
| Air Quality for Contractors: Hawaii | 0.5 5894125 | Oct-17-2023 |
| Asbestos for Contractors: Hawaii | 0.5 5894128 | Oct-17-2023 |
| Building Construction, Demolition or Renovation | 0.5 5894139 | Oct-17-2023 |
| Drinking Water for Contractors: Hawaii | 0.5 5894141 | Oct-17-2023 |
| EMS Awareness Level Training: Hickam | 0.5 5894103 | Oct-17-2023 |
| EMS Awareness Training: Commander Navy Region Hawaii | 0.5 5894111 | Oct-17-2023 |
| Hazardous Materials: Hickam | 0.5 5894149 | Oct-17-2023 |
| Hazardous Waste for Contractors: Hawaii | 0.5 5894159 | Oct-17-2023 |
| Natural and Cultural Resources for Contractors: Hawaii | 0.5 5894161 | Oct-17-2023 |
| Overview of Environmental Compliance for Contractors: Hawaii | 0.5 5894095 | Oct-17-2023 |
| PCBs Management: Hickam | 0.5 5894164 | Oct-17-2023 |
| Pesticides for Contractors: Hawaii | 0.5 5894168 | Oct-17-2023 |
| Petroleum, Oils, and Lubricants Management for Contractors: Hawaii | 0.5 5894173 | Oct-17-2023 |
| Pollution Prevention: Hickam | 0.5 5894181 | Oct-17-2023 |
| Project Manager | 0.5 5894112 | Oct-17-2023 |
| Recycling | 0.5 5894190 | Oct-17-2023 |
| Solid Waste for Contractors: Hawaii | 0.5 5894205 | Oct-17-2023 |
| Spill Response | 0.5 5894219 | Oct-17-2023 |
| Storage Tanks for Contractors: Hawaii | 0.5 5894278 | Oct-17-2023 |
| Stormwater for Contractors: Hawaii | 0.5 5894299 | Oct-17-2023 |
| Waste Management Guidelines | 0.5 5894302 | Oct-17-2023 |
| Wastewater for Contractors: Hawaii | 0.5 5894304 | Oct-17-2023 |
| Wetlands for Contractors: Hawaii | 0.5 5894308 | Oct-17-2023 |





Distribution authorized to U.S. Government Agencies only;
Other requests shall be referred to NAVFAC HI.



Procurement sensitive and proprietary information – This information is exempt from disclosure under 5. U.S.C. § 552(b)(4) because it contains proprietary and procurement sensitive information.

PII – This information is exempt from disclosure under 5 U.S.C. § 552(b)(6), which protects personally identifiable information.



Environmental Compliance Assessment, Training, and Tracking System

ECATTS

Certificate of Accomplishment

[REDACTED]

Has successfully completed the following competencies:

| Course | Credit Hours | S/N | Date |
|--------------------------------------------------------------------|--------------|---------|-------------|
| Air Quality for Contractors: Hawaii | 0.5 | 5929875 | Nov-21-2023 |
| Asbestos for Contractors: Hawaii | 0.5 | 5929889 | Nov-21-2023 |
| Building Construction, Demolition or Renovation | 0.5 | 5929895 | Nov-21-2023 |
| Drinking Water for Contractors: Hawaii | 0.5 | 5929899 | Nov-21-2023 |
| EMS Awareness Level Training: Hickam | 0.5 | 5929852 | Nov-21-2023 |
| EMS Awareness Training: Commander Navy Region Hawaii | 0.5 | 5929859 | Nov-21-2023 |
| Hazardous Materials: Hickam | 0.5 | 5929903 | Nov-21-2023 |
| Hazardous Waste for Contractors: Hawaii | 0.5 | 5930162 | Nov-21-2023 |
| Natural and Cultural Resources for Contractors: Hawaii | 0.5 | 5930882 | Nov-22-2023 |
| Overview of Environmental Compliance for Contractors: Hawaii | 0.5 | 5929396 | Nov-20-2023 |
| PCBs Management: Hickam | 0.5 | 5930887 | Nov-22-2023 |
| Pesticides for Contractors: Hawaii | 0.5 | 5930889 | Nov-22-2023 |
| Petroleum, Oils, and Lubricants Management for Contractors: Hawaii | 0.5 | 5930955 | Nov-22-2023 |
| Pollution Prevention: Hickam | 0.5 | 5930957 | Nov-22-2023 |
| Project Manager | 0.5 | 5929861 | Nov-21-2023 |
| Recycling | 0.5 | 5930958 | Nov-22-2023 |
| Solid Waste for Contractors: Hawaii | 0.5 | 5930960 | Nov-22-2023 |
| Spill Response | 0.5 | 5930965 | Nov-22-2023 |
| Storage Tanks for Contractors: Hawaii | 0.5 | 5930969 | Nov-22-2023 |
| Stormwater for Contractors: Hawaii | 0.5 | 5930974 | Nov-22-2023 |
| Waste Management Guidelines | 0.5 | 5930978 | Nov-22-2023 |
| Wastewater for Contractors: Hawaii | 0.5 | 5930987 | Nov-22-2023 |
| Wetlands for Contractors: Hawaii | 0.5 | 5930990 | Nov-22-2023 |

[REDACTED]

Distribution authorized to U.S. Government Agencies only;
Other requests shall be referred to NAVFAC HI.

Procurement sensitive and proprietary information – This information is exempt from disclosure under 5. U.S.C. § 552(b)(4) because it contains proprietary and procurement sensitive information.

ATTACHMENT 3
SPILL KIT INSPECTION FORM

Distribution authorized to U.S. Government Agencies only;
Other requests shall be referred to NAVFAC HI.

Environmental Protection Plan – Clean Red Hill Tanks

SPILL KIT MONTHLY INSPECTION

| | | | |
|---------------------------|-----------|-----------------------------------------|------------------------------------------------------------|
| Inspector Name: (Printed) | Location: | Total Number of Spill Kits at Location: | Tamper Seal Installed on Spill Kit: (Y / N) Ser. No.: |
|---------------------------|-----------|-----------------------------------------|------------------------------------------------------------|

| Spill Kit Item (minimum required) | Date: | | Date: | | Date: | | Date: | | Comments &/or Corrective Actions |
|--------------------------------------|---------------------------|-----------------|---------------------------|-----------------|---------------------------|-----------------|---------------------------|-----------------|----------------------------------|
| | Signage Posted: (Y / N) | | Signage Posted: (Y / N) | | Signage Posted: (Y / N) | | Signage Posted: (Y / N) | | |
| | Expected Quantity | Actual Quantity | Expected Quantity | Actual Quantity | Expected Quantity | Actual Quantity | Expected Quantity | Actual Quantity | |
| Absorbent pads | | | | | | | | | |
| Absorbent granular | | | | | | | | | |
| Absorbent booms | | | | | | | | | |
| Trash bags | | | | | | | | | |
| Container (bucket) | | | | | | | | | |
| Broom & dust pan | | | | | | | | | |
| Gloves | | | | | | | | | |
| Goggles | | | | | | | | | |
| Coverall | | | | | | | | | |
| Tape | | | | | | | | | |
| Caution tape | | | | | | | | | |

| Additional Items | Expected Quantity | Actual Quantity | Expected Quantity | Actual Quantity | Expected Quantity | Actual Quantity | Expected Quantity | Actual Quantity | Comments &/or Corrective Actions |
|------------------|-------------------|-----------------|-------------------|-----------------|-------------------|-----------------|-------------------|-----------------|----------------------------------|
| Drain Seals | | | | | | | | | |
| | | | | | | | | | |
| | | | | | | | | | |
| | | | | | | | | | |
| | | | | | | | | | |
| | | | | | | | | | |
| | | | | | | | | | |
| | | | | | | | | | |
| | | | | | | | | | |
| | | | | | | | | | |

| | |
|--|--|
| | |
| | |

Procurement sensitive and proprietary information – This information is exempt from disclosure under 5. U.S.C. § 552(b)(4) because it contains proprietary and procurement sensitive information.

ATTACHMENT 4

[REDACTED] RED HILL CONTINGENCY PLAN

Distribution authorized to U.S. Government Agencies only;
Other requests shall be referred to NAVFAC HI.

Environmental Protection Plan – Clean Red Hill Tanks

Procurement sensitive and proprietary information – This information is exempt from disclosure under 5. U.S.C. § 552(b)(4) because it contains proprietary and procurement sensitive information.

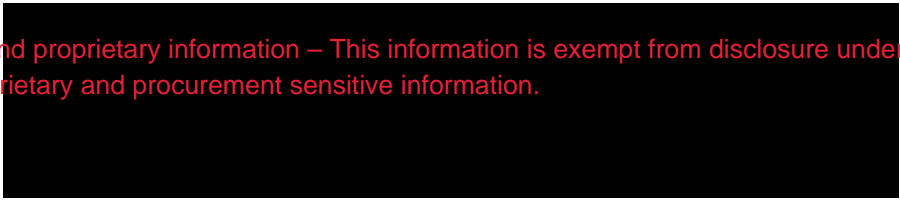

1.0 Introduction

The Contingency Plan shall act as the actionable preparedness plan for the Red Hill Project Site. The Plan addresses the responsible persons, actions, and emergency equipment and resources available and required to prevent incidents, contain spills, react to fires or explosions, and other types of emergency situations that have the potential to harm the environment, the site facility, personnel, or another critical aspect of [REDACTED]'s project site.

The Red Hill Contingency Plan shall be carried out immediately whenever there is a risk, threat, or sudden emergency situation with impact upon the project either directly or indirectly.

1.1 Scope

This procedure applies to all [REDACTED] employees, contractors, subcontractors and visitors associated with this site.

2.0 Site Orientation

█'s Red Hill Project Site is located onboard the bulk fuel storage base known as Red Hill, an annex of Joint Base Pearl Harbor-Hickam. A laydown area has been allotted along Icarus Way near the Adit 4 entrance. The laydown includes four office structures, four conex shipping containers for storage, hazardous material storage, outdoor equipment/material storage, industrial trash collection, restrooms and parking. A detailed image of █'s laydown can be found below. *[Figure 1]*

Various safety and emergency response equipment are readily available throughout █ Adit 4 laydown area. Equipment includes fire extinguishers, spill kits, eye wash stations, first-aid kits, and an automated external defibrillator (AED). The location of all response equipment located at █ laydown areas can be found below. *[Figure 2 and 2.1]*

Red Hill is located in a lower mountainous area of Oahu's Ko'olau Mountain Range. The highest outdoor elevation encountered is less than 400 ft above sea level.

The climate and weather patterns follow along with the tropical climate of Hawaii. Average summertime temperatures are 85°F from June to September. December through April, temperatures are lower averaging 78°F. Strong winds and heavy rainfall can be experienced throughout the year depending on the prevailing wind pattern and its effect upon the island chain.

█ Red Hill Project Site is not in a flood inundation zone. Although, during heavy rains select locations of the site will experience mild flooding along roads and parking lots resulting in muddy, slippery conditions.

Red Hill is not in a tsunami evacuation zone due to elevation. Island-wide, tsunami warning sirens are tested on the 1st of the month at 11:45 a.m., or the following Monday if the 1st falls on a weekend. There is no need to evacuate or respond if the warning sirens signal during this time.

Figure 1: [REDACTED] Red Hill Location Map



Figure 2: Adit 4 Laydown Emergency Response Equipment Location

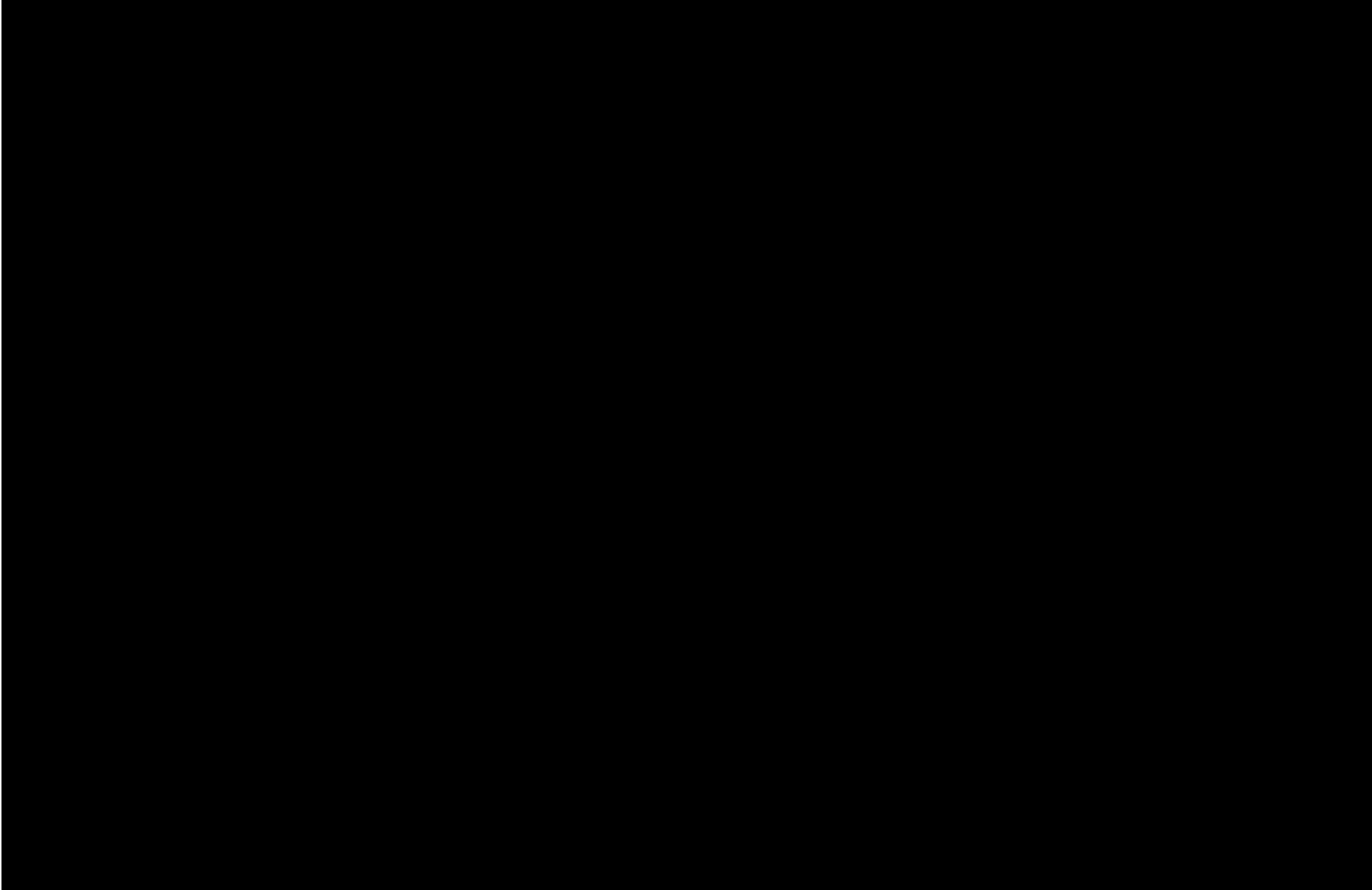
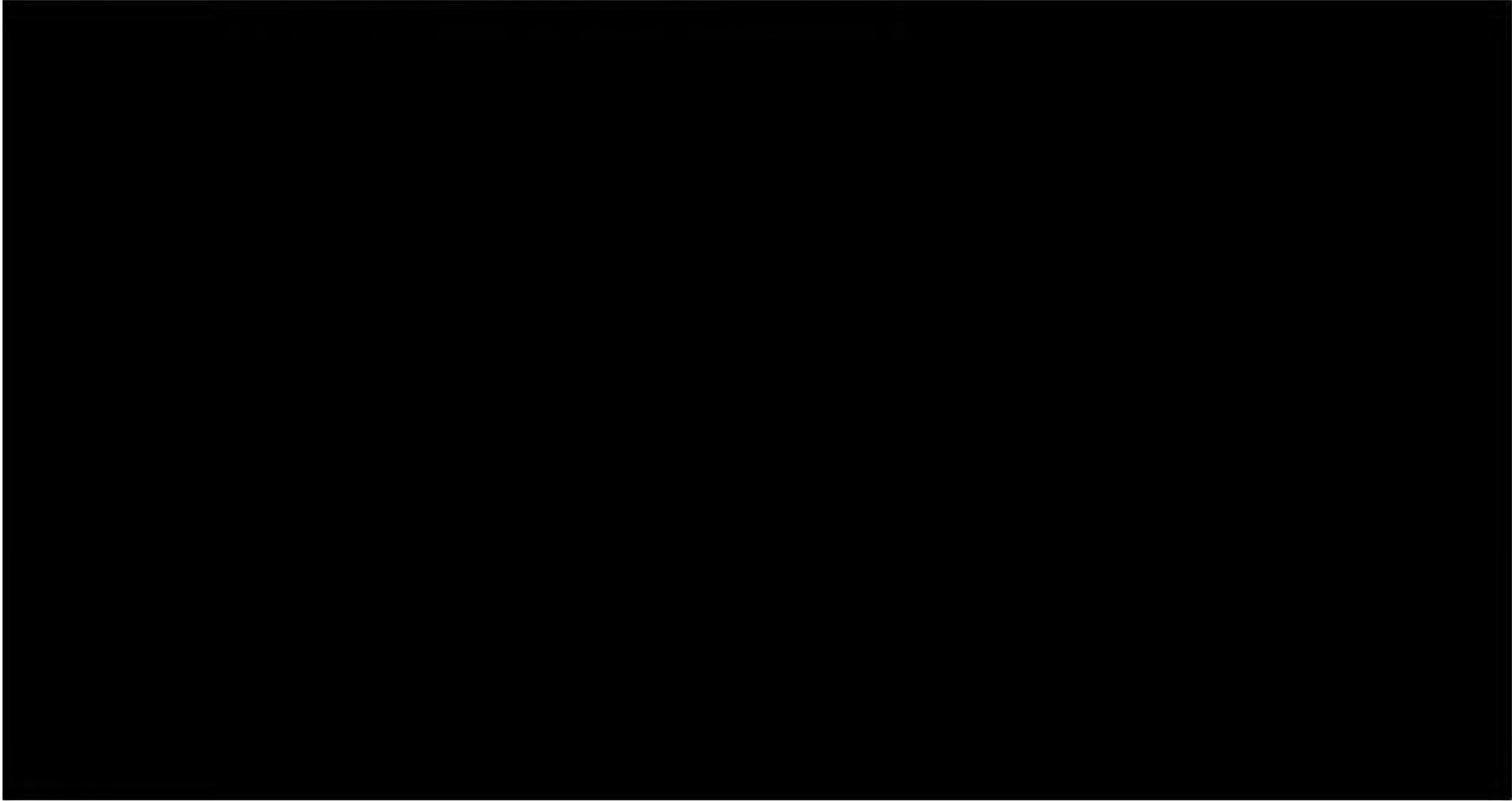

Figure 2.1: CAA Approximate Location and Emergency Response Equipment



Procurement sensitive and proprietary information – This information is exempt from disclosure under 5. U.S.C. § 552(b)(4) because it contains proprietary and procurement sensitive information.

PII – This information is exempt from disclosure under 5 U.S.C. § 552(b)(6), which protects personally identifiable information.

3.0 [REDACTED] Red Hill Emergency Action Committee

The Emergency Action Committee [Table 1] shall carry out all duties and responsibilities in the event emergency response occurs at the job site. The positions and responsibilities are as follows:

Table 1: Emergency Action Committee (EAC)

| Position | Primary | Alternate |
|-----------------------------------------------|------------|------------|
| Emergency Coordinator (Incident Commander) | [REDACTED] | [REDACTED] |
| Evacuation Coordinator | [REDACTED] | [REDACTED] |
| Communication Coordinator | [REDACTED] | [REDACTED] |
| Emergency Supplies Coordinator | [REDACTED] | [REDACTED] |

Emergency Coordinator shall:

- Be responsible for the implementation of all personnel and medical records.
- Make the decision to evacuate or take any other measures in the event communications are disrupted with the [REDACTED]
- Coordinate necessary actions with the client and other contractors in the area.
- Communicate and coordinate with various [REDACTED] sites and offices.

Evacuation Coordinator shall:

- Be responsible for the accounting of all personnel at the assembly point.
- Coordinate suitable transportation to the local airport, alternative airports, seaport or other locations.
- Collect and keep available details of all personnel and medical records.
- Contact Medical/Ambulance/Other Emergency Services.
- Procure tools, equipment and spare parts for vehicles used in evacuation.
- Be responsible for maintaining a sufficient quantity of reserve fuel for vehicles to be used in evacuation.

Communication Coordinator shall:

- Be responsible for relaying instructions and information from the Emergency Coordinator to all personnel.
- Immediately relay all information received to the Emergency Coordinator.
- Issue emergency news information to the [REDACTED] [REDACTED] as required.
- Maintain information on Next of Kin of personnel assigned to the Site, including Name, Relationship, Address and Telephone Number.

Emergency Supplies Coordinator shall:

- Ensure the procurement and delivery of adequate emergency supplies for anticipated emergencies are on hand to include emergency medical supplies, potable water, gasoline and diesel in sufficient quantities for all employees who may be standing by at our facility.

EAC Organizational Structure

The Red Hill Fuel Facility EPP organizational structure depicted below [Figure 3] identifies command relationships and functional responsibilities. This structure is intended for use as a whole or in part based on situational requirements.

Figure 3: [REDACTED] EAC Communication and Authority Structure

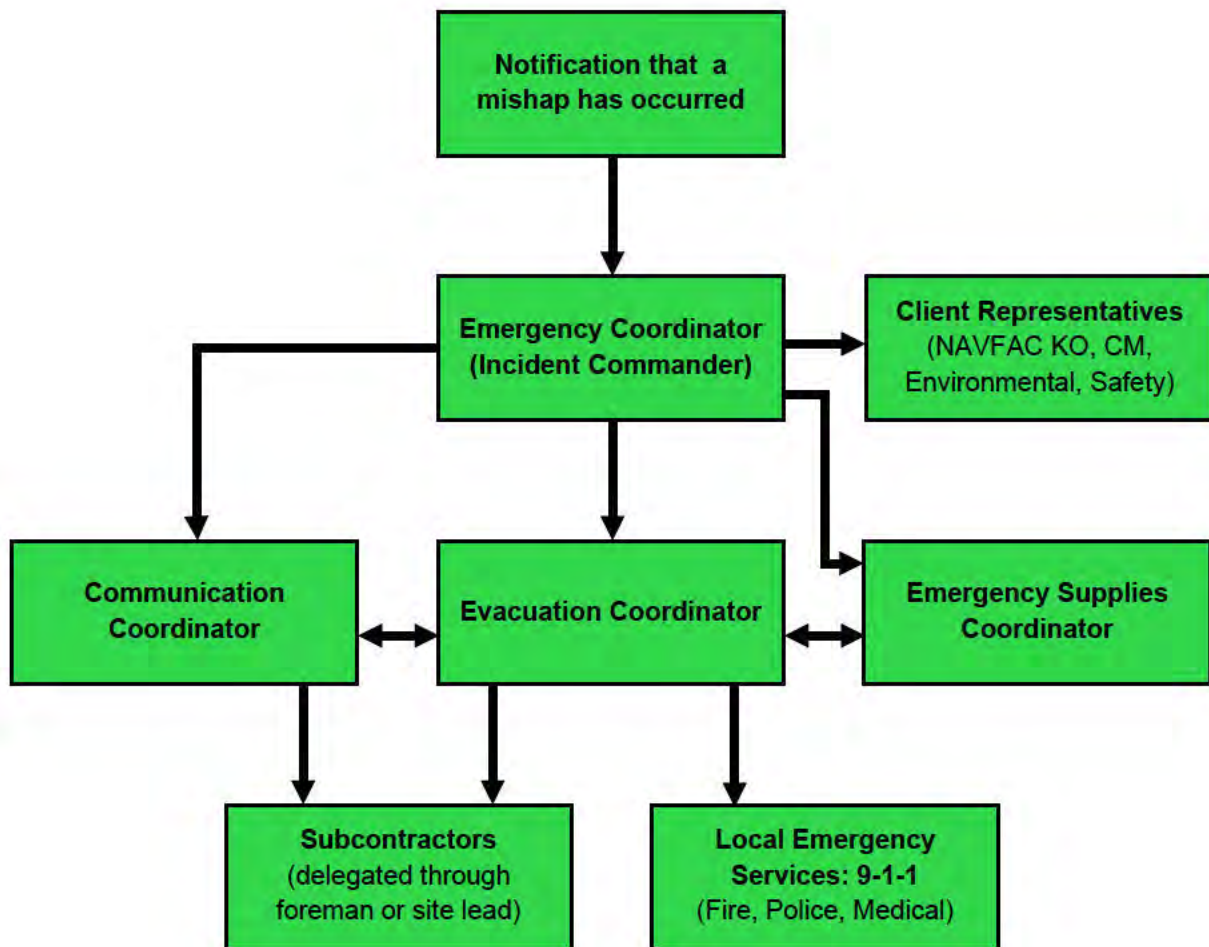

4.0 Emergency Communications

Primary mode of communication is use of 2-way radios using the tanks individual selected channel established prior to work during the Daily Safety Meeting. In the event of an emergency, Channel #1 will be utilized by all personnel for communication.

In the event radio communication is not available nor feasible, small portable airhorns are readily accessible for signaling. Communication is carried out through the performance of 1, 2 or 3 air blasts signaling different alerts and responses. 3 horn blasts signals STOP WORK and EVACUATE IMMEDIATELY.

Hardwired internal-only phone lines are routed as direct communication between worksites and [REDACTED] offices to signal personnel in the event an emergency is occurring at any location. Phones are located throughout the upper and lower tunnels of the tank gallery, various adits, throughout the harbor tunnel, and the [REDACTED] offices.

Outside of the Red Hill Underground Facility, cell phones are able to be utilized as communication.

5.0 Company Vehicle Operation

All employees driving and/or in company vehicles, to include golf carts, trucks, heavy machinery etc., shall follow all local, state, and federal laws.

The use of mobile devices to include cell phones, cameras, and music players is prohibited while operating company vehicles, except when a hands-free device is authorized.

██████ vehicles could be involved in incidents inside the boundary limits of the facility or outside. This could involve property damage, injury, or pollution. A flexible approach will be needed as many factors may be involved. Site management will liaise with the relevant police authority with regard to incidents involving its employees or any of its vehicles.

A damaged or improperly operating company vehicle shall be considered out of service until repaired.

If property damage, injury, hospitalization, or fatality occurs, determine severity level and correlating response action.

6.0 Security Threat

Employees have the responsibility to question any person(s) that may be unknown on site. Requests to see identification may be made or employees may alert facility security personnel to investigate.

Any suspicious activity or area that does not look safe and secure shall be reported to security forces.

Incidents caused by malevolent acts can be difficult to respond to. Support from local police forces may be needed considering the nature of security breaches, otherwise the emergency response follows the same pattern as other incidents.

EAC shall determine if security threat presents a threat or risk to the project and determine severity level and correlating response action.

7.0 Hazardous Spills or Release

All persons involved, including subcontractors to [REDACTED], with the possibility of a spill or release of a hazardous substance shall be made aware of any actions or responsibilities and able to perform them if necessary.

Non-permeable secondary containment shall be provided for all hazardous material and waste stored on-site.

Secondary containment for liquids shall be capable of holding at minimum 110% of the largest container within the containment.

[REDACTED]s Red Hill Facility is not required to develop a Spill Prevention Control and Countermeasures (SPCC) plan as it does not meet the requirements set forth by governing law.

A Spill Prevention Control and Countermeasures Plan is required by the Clean Water Act for sites that have a total of 1320 gallons of oil/fuel (660 in some states) stored above ground or 42,000 gallons stored below ground.

Spills and harmful releases severity level shall be determined and respective actions put into effect. If response clean-up can be accomplished without fatal or long-term exposure effects, spill response efforts shall commence.

The following steps shall be carried out in the event of a hazardous substance spill:

- Project personnel will stop the source of the spill; deactivate all applicable power sources and/or emergency stop buttons.
- Immediately notify environmental managers, site management and safety personnel, HSE manager, the customers' representatives, or other personnel designated on the EAC Communication and Authority Structure (Figure 3). Due to many worksites being underground without cell-service, on scene notifications shall be made in a manner that results in immediate confirmation of receipt such as by phone call or radio, or in person if possible.
- Clear the location of all persons except those trained to deal with the incident.
- Clean up shall be performed by qualified personnel only.
- Absorbents will be placed to clean up all products and prevent further spread of contamination.
- All absorbent materials and fluids must be contained in DOT-approved open-top drums.
- All absorbent materials and fluids must be assumed to be contaminated until demonstrated otherwise.

- Drums shall be clearly marked according to contents, accumulation date, and known or suspected hazard(s). Drums shall be marked “Pending Analysis” until such time as results have been received from the laboratory.
- Drums shall be segregated into a separate, marked holding area.
- Notify appropriate personnel when the spill has been successfully cleaned.
- Notify Waste Coordinator of all waste accumulated to ensure collection, storage, and disposal of all waste is conducted as required.
- Samples of the spill residue and materials used in the spill cleanup must be collected.
- Materials shall be disposed of in accordance with Department of Health and Environmental Protection Agency requirements.
- Copies of the sample analysis and a letter stating the disposition and location of the disposal will be provided to the NTR and the facility.
- Spilled materials, contaminated soils and water, absorbents, and miscellaneous spill related debris require proper handling. [REDACTED] will properly dispose of these materials and any other materials associated with spill containment and cleanup.

Once the spill is under control by [REDACTED] s Incident Commander, or when adequately possible, notification to first responders (i.e., installation Fire Department, the Installation, Command Duty Officer, Installation Environmental Office, the JBPHH Regional Dispatch Center, and the Contracting Officer) should be made in parallel with spill mitigation actions. To the extent practicable, notification must include date and time spill occurred or was discovered, location, specific substance spilled, spill volume, operation underway when the spill occurred, and response actions taken or planned.

Throughout the project worksites, and at active tank locations, emergency notification signage will be posted. Emergency contacts at a minimum shall include Environmental Managers, Site Superintendent, project management personnel, and emergency response contacts.

8.0 Fire and Explosion

It has been demonstrated that personnel who have been intensively drilled in the proper procedures to follow in a fire emergency, react swiftly and correctly to minimize danger to themselves and their fellow employees, and are better prepared to take fire control measures until local fire authorities arrive on the scene.

8.1 Discovering the Fire

Any person discovering a fire, should quickly and carefully remove anyone who is injured or in immediate danger. This person must be careful not to risk injury to themselves, as it is most important that they remain conscious and able to report the fire.

8.2 Reporting the Fire

CALL 9-1-1 or refer to section 11.0.

When possible, the nearest telephone should be used to report the fire, with the individual reporting the fire providing the following information:

- There is a fire
- What is on fire
- The specific location of the fire
- Name, phone number, location of person reporting the fire
- Report number and names of injured or missing personnel
- Request the response of emergency service vehicles
- Notify of any known road or access restrictions with the site

Time permitting, the manual pull fire alarm reporting system should be activated.

9.0 Emergency Notification-Sounding the Alarm

9.1 Audible Alarms

Air horns shall be available to warn employees inside underground storage tanks and tunnels of hazards or the need for evacuation.

- 3 horn blasts are used to signal immediate evacuation

Fire alarms are installed throughout the facility and includes a pre-recorded message. There is a public address system installed throughout the facility. The fire alarm requires all employees to evacuate to the nearest adit. After exiting an accountability check must be conducted by the SSHO assigned to each underground storage tank where work is being performed.

- Radio calls shall be made to all work sites to evacuate.
- If time permits, use internal phone system to notify all tanks and offices of fire and evacuation.
- Ensure all notified workers are properly aware of what the alarm represents and exit.

9.2 Visual Alarms

The Red Hill Fuel Facility is equipped with strobe lights. The lights and audible alarms operate in conjunction with each other and require all personnel to evacuate to the nearest adit.

10.0 Evacuation

When evacuation is necessary, there must be no hesitation in requiring personnel to immediately vacate the area. Follow emergency exits and other means of egress from the area.

Evacuate to muster location and do not return until all-clear given by authorized person(s).

10.1 Evacuation Routes

Evacuation routes are posted throughout the Red Hill Fuel Facility. Evacuation routes utilize the tunnels that are well lit and wide enough to accommodate the evacuating personnel. Weekly inspection of the evacuation routes will be conducted to ensure they are unobstructed, clear of debris and do not expose evacuating personnel to additional hazards. Evacuation route maps for Red Hill can be found in *Attachment 1.0*.

10.2 Assembly Points

In case of evacuation:

- Use nearest facility exit or Adit to your location.
 - Workers exiting via distant Adits (1, 2, or 3) shall report into [REDACTED] project team via phone or radio to notify of safe evacuation and to arrange transportation to primary assembly points if needed.
- Personnel will use the emergency assembly points as noted below.
- Assembly points are designated outside of Adit 4 and Adit 5.
- Employees must stay at least 50 feet away from access routes of emergency vehicles.

Table 4: Evacuation Assembly Points

| Location | Primary Assembly Point | Secondary Assembly Point |
|----------|----------------------------------|-----------------------------------|
| On-Site | Adit 4 (APTIM Office) | Adit 5 |
| Off-Site | Halawa Main Security Access Gate | Halawa Valley Correctional Center |

10.3 Personnel Accounting

Employees will be accounted for through the following method:

- Employees will gather at designated assembly points.
- Employees will remain in the assembly areas until released.
- A head count will be taken by the work site SSHO or Foreman.
- The SSHO or Foreman will provide the head count along with a list of personnel unaccounted for to the Evacuation Coordinator.

- The SSHO or Foreman will conduct a reconciliation between the primary and secondary assembly points, list of known visitors, and the attendance list.
- The SSHO or Foreman will provide a remaining list of unaccounted personnel to the Evacuation Coordinator.
- The Evacuation Coordinator will provide the list of unaccounted personnel to the Rescue Team Leader.
- The Rescue Team will attempt to locate unaccounted personnel in the affected area.
- Non-employees and visitors will be required to follow this plan and will be accounted for in a similar manner.

11.0 Coordination with Local Emergency Agencies.

The primary dispatch center for the facility is JBPHH Regional Dispatch Center (RDC) (808) 474-2222. All 9-1-1 calls made from the facility are routed to this number. They coordinate with Federal Fire Dept, law enforcement, security and local utilities to support critical needs based on the situation. Federal Fire HAZMAT is the primary agency to respond a fuel spill or chemical release.

- If Federal Fire HAZMAT is unable to respond immediately, Honolulu Fire Dept may be contacted to support spill response efforts.
- The National Response Center is available at 800-424-8802 to report an oil or chemical spill.
- Immediately after a reportable release, the owner or operator of a facility or vessel must notify the HEER Office (for the HSERC), the Local Emergency Planning Committee (LEPC) of the appropriate jurisdiction, and the National Response Center (NRC).

Any spills that involve release of fuel from pipelines or tanks with the Red Hill Fuel Storage facility also require a notification to the Red Hill Pump House by contacting 808-471-8081.

12.0 Critical Equipment Shutdown

████████ owned and operated power generators must be shut down after all employees have exited the facility. All auxiliary power to project equipment will be secured from electrical power at this time. The emergency coordinator is responsible for the shutdown of generators and the return to service conditions.

13.0 Emergency Equipment

13.1 Fire Extinguishers

Fire extinguishers owned and inspected by the Navy Fuels Group are located throughout the facility and available to use if needed.

At each work site location where operations are being conducted, fire extinguishers owned and maintained by [REDACTED] are located near the worksite, inside the alcoves, and each work platform (including suspended scaffolds and boom baskets).

[REDACTED] owned fire extinguishers are also located in each company vehicle and various locations around the Adit 4 laydown yard at the office complex.

13.2 Spill Kits

Emergency spill kits are located within the upper and lower alcoves of each active fuel tank and at various locations in the laydown yard where flammables or hazardous materials are stored or used. These are inspected monthly to ensure supplies are stocked to cover various releases of hazardous constituents.

13.3 First Aid Kits

First aid kits are located at each active worksite, tanks, on at Safety Bulletin Boards in the tunnel near upper alcove entrances.

First aid kits are also located inside company vehicles and on the Safety Bulletin Board located at the office complex.

13.4 Automated External Defibrillator (AED)

Automated external defibrillators are available for cardiac emergencies. AEDs are located at the Adit 4 laydown office complex on the safety message board, and will be available at or near active worksites throughout the facility as the project progresses. A training device is kept onsite and incorporated into training events.

13.5 Rescue Kit

A Gravitec G4 Rescue and Evacuation Kit (descender, anchor straps, pulleys, rope and carabiners), SKED personnel recovery device, Stokes stretcher basket, and Quick-Pick rescue pole are located in the alcoves of each active tank to assist confined space rescue or injured personnel movement in the event of an emergency.

13.6 Eye Wash Station

Large emergency eye wash stations with a minimum 15-minute discharge time are provided at each active alcove inside the facility. Smaller 32oz eye wash bottles are also provided throughout and at the Adit 4 laydown and near the hazardous material storage flammable cabinets. Eye wash stations may be used at any time necessary to include when irritation is experienced due to a foreign object in the eye of an employee.

13.7 Self-Contained Self-Rescue (SCSR) Escape Breathing Device

In the event an emergency occurs that requires escape through a hazardous atmosphere, Ocenco emergency breathing devices are provided in the lower tunnel system near active work sites. The devices are located in a marked rolling toolbox.

The EBA 6.5 is a self-contained, closed circuit breathing apparatus using compressed oxygen as a source rather than generating oxygen from chemicals. The rugged clear case allows the worker to quickly and accurately visually assess the condition of the device. The oxygen delivery system allows the user to inhale immediately from the device when donned and provides up to 100 liters of oxygen flow during high work rates. Manual adjustment of the oxygen valve will provide a user at rest up to 8 hours of respiratory protection.

Instructions for donning and use of breathing devices are located on the toolbox and on the device cover itself. [REDACTED] has the SCSR training device onsite and incorporates its use during exercises. New workers to the site are trained initially in its use and function.

14.0 Emergency and Medical Services

██████ will provide rapid first-aid and trauma response at the casualty location, followed by stabilization and evacuation to a specialized medical care facility.

The Red Hill project has multiple personnel trained and certified in the application of first-aid, CPR, and AED units. All ██████ employees shall receive retraining as necessary.

Urgent Care and Emergency medical facilities are located within a short distance of the Red Hill Facility. A map [*Attachment 2.0*] is provided showing the fastest routes and average travel time.

14.1 Off-Site Emergency Medical Services:

Pali Momi Medical Center
98-1079 Moanalua Road
Aiea, Hawaii 96701
(808) 486-6000

Kaiser Permanente Moanalua Road Emergency Department
3288 Moanalua Road
Honolulu, Hawaii 96819
(808) 432-0000

Additional emergency and medical care contact numbers can be found in *Attachment 3.1*.

Notification of injury or illness shall be reported to the employee's management as soon as possibly achievable.

If any employee under ██████'s job site responsibility must be admitted into medical care, a designated ██████ representative shall accompany them at the facility. Transportation to and from shall be coordinated by the Site Project Manager and Site HSE Manager.

15.0 Rescue

15.1 Assisted Rescue

Rescue Services are available and provided by JBPHH Federal Fire Department. Fed Fire can provide medical, confined space, elevated high rescue, fire, and IDLH rescue scenarios.

Federal Fire Department is located at:
650 Center Drive
Building 284
Joint Base Pearl Harbor-Hickam 96860
(808) 471-3303, or dial 9-1-1

15.2 Self-Rescue

█ and Red Hill subcontractor █ have successfully developed and accomplished confined space tank rescue drills. In the event a rescue must be performed, trained qualified individuals shall perform or lead the rescue effort per the site-specific Rescue Plan.

If a rescue is performed and medical services have not yet arrived at the adit or tunnels, rescue teams are trained to continue down the road as far as possible to reach emergency service vehicles. Complications such as base access, traffic, or tight access roads may arise as an unseen delay. It is of note, the rescue team should remain in contact with emergency call center personnel to notify that the response location is changing.

16.0 Critique of Response

Whenever the Contingency Plan is implemented in response to an incident or a drill, an internal critique of the response shall be conducted and documented.

Attachments

- | | |
|-----------------------------------|---------------------------------------|
| 1.0 Evacuation Maps | 1.1 Upper Tunnel Evacuation Map |
| | 1.2 Lower Tunnel Evacuation Map |
| 2.0 Medical Care Facility Maps | 2.1 Kaiser Permanente Emergency Room |
| | 2.2 Pali Momi Urgent Care Facility |
| 3.0 Emergency Contacts | 3.1 Project Emergency Contact Numbers |

Red Hill Upper Tunnel Exit Plan

Primary exit location determined based upon current location in upper tunnel

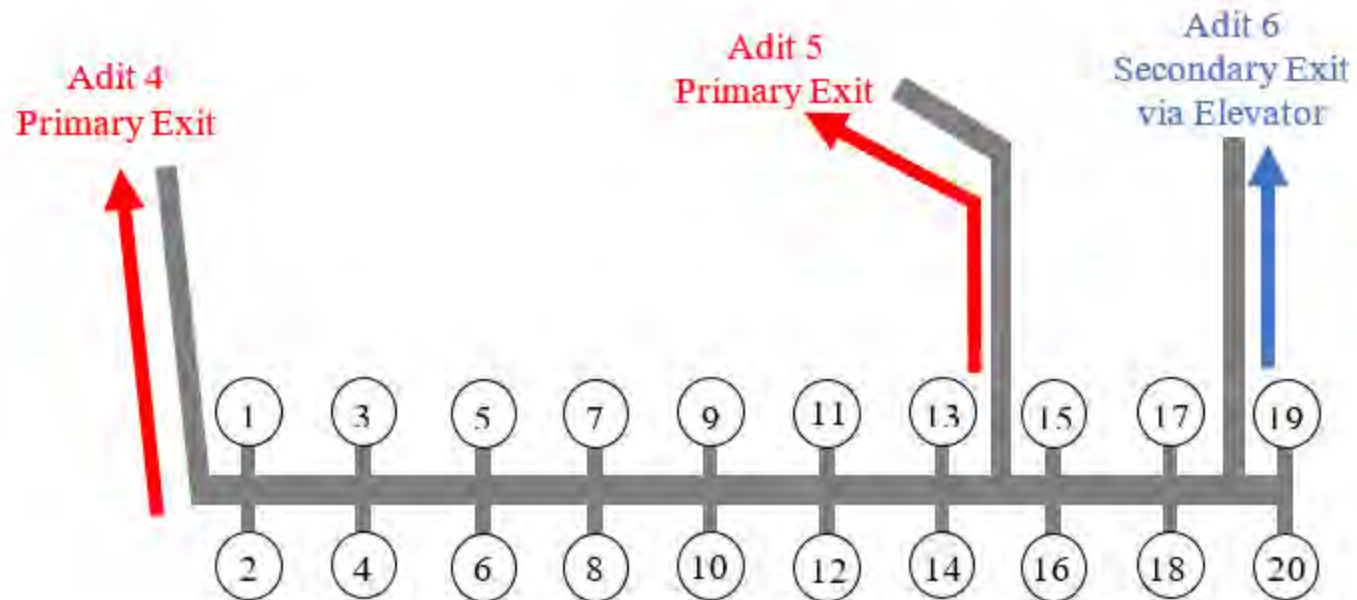

Red Hill Lower Tunnel Exit Plan

Primary exit location determined based upon current location in lower tunnel

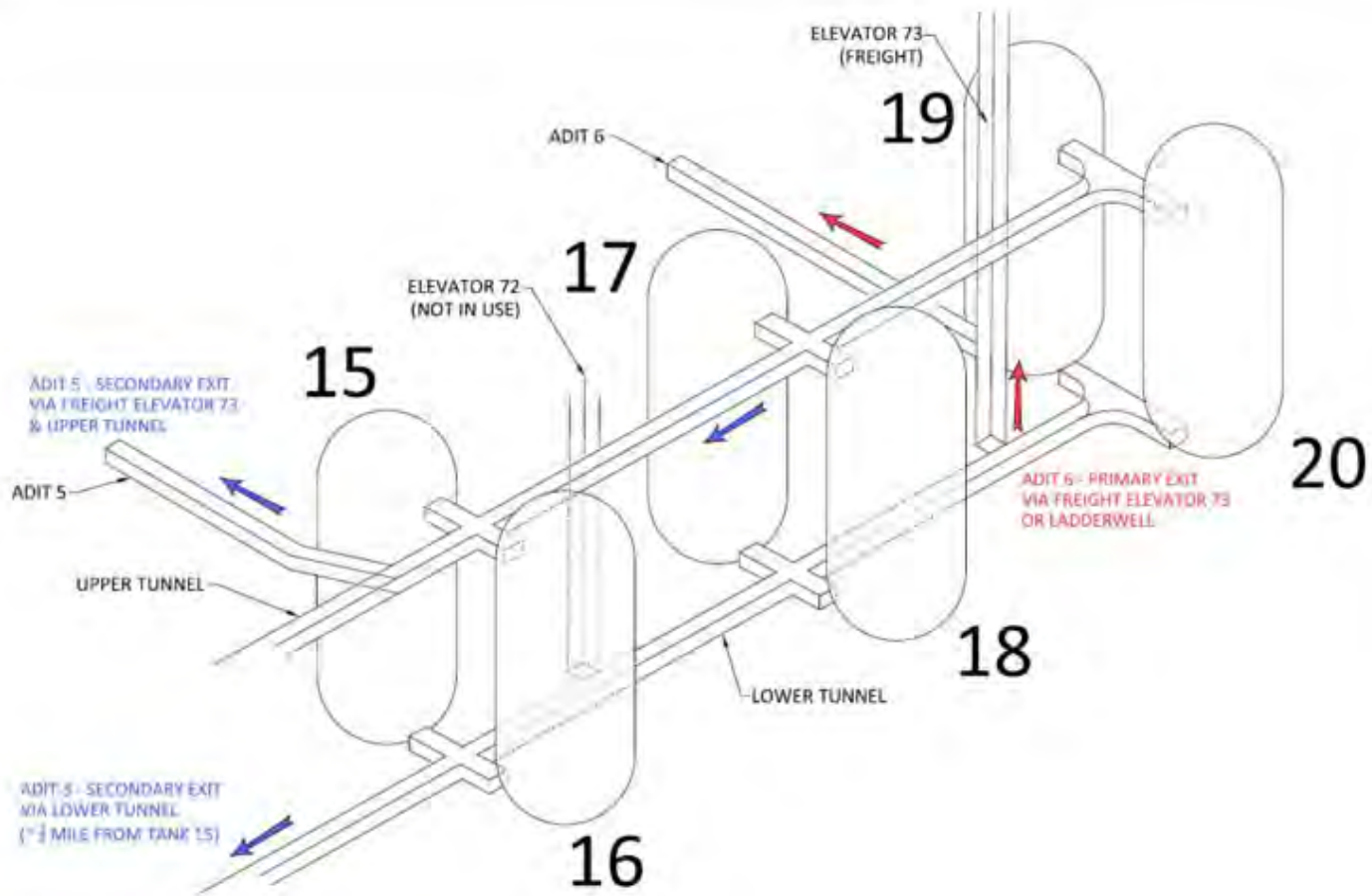

[Attachment 2.1]

12 min (4.0 miles)
via Halawa Valley St
Fastest route, despite the usual traffic

Aiea
Hawaii 96701

- > Take Halawa Valley St to Ulune Extension in Halawa
4 min (1.6 mi)
- > Take I-H-201 E to Moanalua Rd. Take exit 2 from I-H-201 E
3 min (1.5 mi)
- > Continue on Moanalua Rd to your destination
3 min (1.0 mi)

Kaiser Permanente Moanalua
3288 Moanalua Fwy, Honolulu, HI 96819

Halawa
Aiea, HI 96701
Moanalua Golf Club
Kaiser Permanente Moanalua
MOANALUA

ALIAMANU - SALT LAKES - FOSTER VILLAGE

12 min
4 miles

[Attachment 2.2]

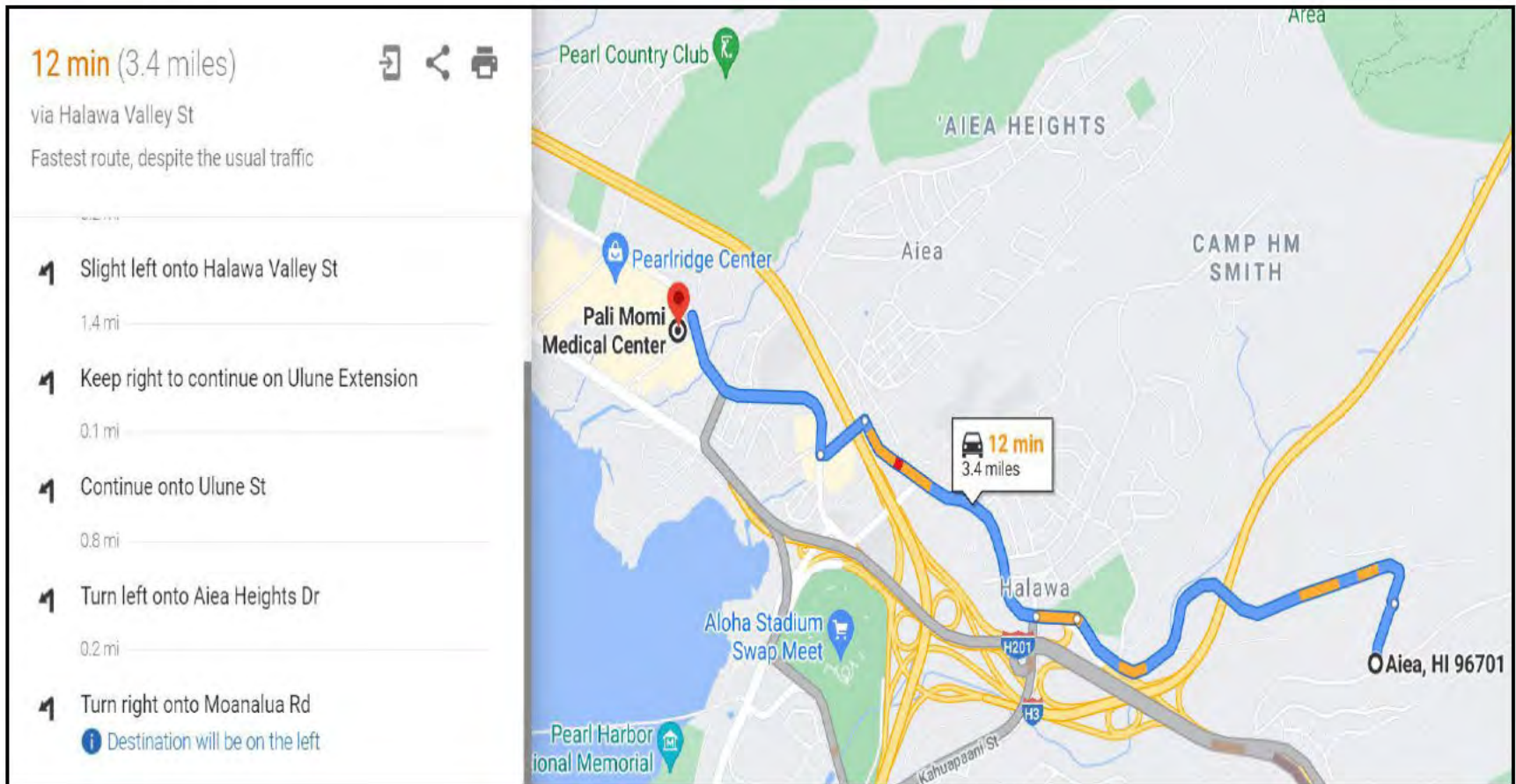

[Attachment 3.1]

IN CASE OF EMERGENCY

Important Emergency Phone Numbers

| | |
|---------------------------------------------------|----------------|
| Emergency Services | 9-1-1 |
| JBPHH Regional Dispatch Center (RDC) | (808) 471-7117 |
| JBPHH Federal Fire Department | (808) 471-3303 |
| NAVFAC CDO | (808) 397-8289 |
| JBPHH QI (Qualified Individual) | (808) 864-2463 |
| NOSC-R (Navy On-Scene Coordinator Representative) | (808) 371-0448 |
| NAVFAC Environmental Branch | (808) 471-3858 |
| National Poison Control Hotline | (800) 222-1222 |
| National Response Center | (800) 424-8802 |

Government Contacts

| | |
|-----------------------------|----------------|
| Red Hill Pump House (PAPA) | (808) 471-8081 |
| NAVFAC Construction Manager | [REDACTED] |
| NAVFAC Construction Manager | [REDACTED] |

| | |
|----------------------|----------------|
| Core Health Networks | (877) 347-7429 |
|----------------------|----------------|

| | |
|----------------------------------------|------------|
| [REDACTED] | [REDACTED] |
| Project Manager | [REDACTED] |
| Deputy Project Manager | [REDACTED] |
| Construction Manager | [REDACTED] |
| Site Superintendent | [REDACTED] |
| Quality Control Manager | [REDACTED] |
| Build Engineer | [REDACTED] |
| Health, Safety and Environment Manager | [REDACTED] |
| Site Safety and Health Officer (SSHO) | [REDACTED] |
| Site Safety and Health Officer (SSHO) | [REDACTED] |

Medical Facilities

| | |
|---------------------------------------------|----------------|
| Kaiser-Permanente Moanalua - Emergency Dept | (808) 432-0000 |
| Pali Momi Medical Center | (808) 486-6000 |

ATTACHMENT 6B: WASTE MANAGEMENT PLAN - REDACTED

[RETURN TO TABLE OF CONTENTS](#)



JANUARY 2024

WASTE MANAGEMENT PLAN

**Clean Red Hill Tanks, JBPHH, Hawaii
Joint Base Pearl Harbor-Hickam Oahu, Hawaii**

Naval Facilities Engineering Command
[REDACTED]

[REDACTED]

Revision: 0

Submitted by:

[REDACTED]

[REDACTED]

CONTENTS

| | |
|-------------------------------------------------------------------------------|-----------|
| 1.0 Introduction..... | 1 |
| 2.0 Waste Coordinators..... | 2 |
| 3.0 Identification of Waste Streams | 3 |
| 4.0 Waste Characterization..... | 4 |
| 5.0 Waste Packaging | 5 |
| 5.1 Waste Packing..... | 5 |
| 5.2 Waste Labeling and Marking..... | 5 |
| 6.0 Waste Transportation..... | 6 |
| 7.0 Treatment and Disposal | 7 |
| 7.1 Treatment/Disposal Facility Selection | 7 |
| 8.0 Waste Documentation..... | 10 |
| 8.1 Hazardous and Non-Hazardous Waste Shipment Documentation Procedures | 10 |
| 8.2 Exception Reports..... | 11 |
| 8.3 Discrepancy Reports | 11 |
| 8.4 Recordkeeping | 11 |
| 9.0 Waste Management | 12 |
| 9.1 Containers and Labeling | 12 |
| 9.2 Container Selection, Management, and Secondary Containment | 13 |
| 9.3 Accumulation Areas..... | 13 |
| 9.4 Disposal | 16 |
| 9.5 Procedures for Handling Rejected Load of Hazardous Waste | 16 |
| 9.6 Hazardous Material (including waste) Transportation..... | 17 |
| 9.7 On-island or Off-Island Disposal of Non-Hazardous Waste..... | 17 |
| 9.8 Off-Island Disposal of Hazardous Waste..... | 18 |
| 10.0 Contingency Plan | 19 |
| 11.0 References | 20 |

LIST OF ACRONYMS AND ABBREVIATIONS

| | |
|-----------------------------------------------------------------------------------|-----------------------------------------------------------------------------------|
|  |  |
| ASD | Accumulation Start Date |
| CFR | Code of Federal Regulation |
| CY | cubic yard |
| DOT | U.S. Department of Transportation |
| EPA | U.S. Environmental Protection Agency |
| LDR | Land Disposal Restrictions |
| NAVFAC | Naval Facilities Engineering Systems Command |
| PPE | Personal Protective Equipment |
| RCRA | Resources Conservation and Recovery Act |
| SAA | Satellite Accumulation Area |
| TSDF | Treatment, Storage and Disposal Facility |

LIST OF TABLES

| | |
|---------|---------------------------------------------------------|
| Table 1 | Waste Coordinators |
| Table 2 | Summary of Anticipated Waste Streams |
| Table 3 | Waste Testing Requirements |
| Table 4 | Waste Recycle/Disposal Method and Proposed Facilities |
| Table 5 | Less Than 90-day Central Accumulation Area Requirements |
| Table 6 | Satellite Accumulation Area (SAA) Requirements |

LIST OF APPENDIXES

| | |
|------------|---------------------------------|
| Appendix 1 | Universal Waste Management Plan |
|------------|---------------------------------|

1.0 INTRODUCTION

The purpose of this Waste Management Plan is to ensure that all waste generated during tank cleaning activities will be managed in compliance with the state and local government regulations and to leave the site in no worse condition after project completion. This plan governs the minimalization, generation, management, storage, and transport and disposal of waste that are routinely encountered during tank cleaning. [REDACTED] has been tasked to conduct tank cleaning operations at Red Hill Bulk Fuel Storage Facility, Oahu, Hawaii through Contract number [REDACTED] Order [REDACTED]

All work will be conducted in accordance with Statement of Work entitled “Clean Fuel Storage Tanks for Closure, Joint Base Pearl Harbor-Hickam, Hawaii,” dated Fiscal Year 2023.

PII – This information is exempt from disclosure under 5 U.S.C. § 552(b)(6), which protects personally identifiable information.

2.0 WASTE COORDINATORS

Waste onboard [REDACTED] site is identified, documented, stored, and disposed of by a qualified Waste Coordinator. The qualified person(s) is responsible for maintaining compliance with the [REDACTED] Waste Management Plan and Title 29, 40, and 49 Code of Federal Regulations.

Waste Coordinators shall remain current with training qualifications such as Hazardous Waste Operations and Emergency Response (HAZWOPER) and training in line with 49 CFR part 172 “Hazardous Materials Table, Special Provisions, Hazardous Materials Communications, Emergency Response Information, Training Requirements, and Security Plans”. Training certifications are provided in the Project Environmental Protection Plan.

The Waste Coordinators have completed the online Environmental Compliance Assessment Training and Tracking System (ECATTS) training. Prior to waste handling, training will be documented for [REDACTED] and subcontractor personnel. On-site training will be conducted to familiarize employees of the requirements following [REDACTED] procedures and contract requirements.

The [REDACTED] Waste Coordinators (Table 1) prepare the hazardous and non-hazardous waste documentation for review and signature by authorized government personnel, unless otherwise specified.

A project waste management meeting will be held with the Contracting Officer to discuss the proposed Waste Management Plan and establish a mutual understanding relative to the management of waste and how diversion requirements will be met. The coordination and mutual understanding meeting may be used to settle this requirement. Waste management goals and project timelines will be discussed at the preconstruction meeting, regular quality control meetings, and morning safety tailgate meetings when applicable to the project job tasks for that day.

Prior to project evolutions that will result in the accumulation of hazardous or non-hazardous waste, Waste Coordinators will conduct a meeting to address details such as:

- Identify the production process
- Potential spill scenarios and control measures
- Waste containers to be used
- Secondary containment
- Spill kit contents and locations
- Waste documentation forms and information to be sent for government approval
- Accumulation areas if applicable

TABLE 1: WASTE CORRINATORS

| Name | Project Position | Phone Number | Email |
|------------|------------------------------------------------|--------------|------------|
| [REDACTED] | Dep. Project Manager, Environmental Manager | [REDACTED] | [REDACTED] |
| [REDACTED] | SSHO | [REDACTED] | [REDACTED] |

3.0 IDENTIFICATION OF WASTE STREAMS

Table 2 will be used as a guideline for the management of anticipated waste streams for this project.

TABLE 2: SUMMARY OF ANTICIPATED WASTE STREAMS

| Potential Waste Stream | Description | Estimated Quantity |
|----------------------------------------------------------------|--------------------------------------------------------------------------------------------------------------------------------------------------------------------------------------------------------------|----------------------------------------------------------------------------|
| Residual fuel, sludge, sediment, or deleterious material | Non-flowable residual product after tank draining | ~3,000 gallons or 72 barrels per tank |
| Oily water/tank wash water | Tank cleaning with detergent wash water | ~36,000 gallons per tank (estimated from previous tank cleaning performed) |
| Spent personal protective equipment (PPE) and absorbent debris | Spent PPE and absorbent pads/rags | 2 each 55-gallon drums per tank |
| Ordinary trash | Ordinary trash will consist of paper materials, plastic cups and plastic bags, trash bags, and food waste. Ordinary trash will be bagged and disposed off-site at an approved solid waste facility on island | ~1 cubic yard (CY) per tank (estimated per previous project) |
| Scrap metal | Scrap metal accumulated from tank piping, ventilation, and tank demolition and fabrication; waste metal containers | ~5 CY per tank (estimated per previous project) |

Additional process related waste relating the project tasks shall be managed accordingly to [REDACTED] Universal Waste Management Plan, this plan, and applicable Title 40 and 49 CFR regulations. This waste streams could include dead batteries, inoperable bulbs, cleaning material, and generator maintenance waste.

4.0 WASTE CHARACTERIZATION

To ensure proper disposal, all project wastes must be characterized in accordance with 40 Code of Federal Regulations (CFR) Parts 261, 262, and 279, applicable state laws and regulations. Table 3 summarizes the testing requirements and analytical laboratories to perform the tests for each waste stream.

TABLE 3: WASTE TESTING REQUIREMENTS

| Potential Waste Stream | Testing Requirements (U.S. Environmental Protection Agency Method) | Estimated # of samples | Testing Laboratories |
|----------------------------------------------------|-----------------------------------------------------------------------------------------------------------------------------------------------------------------------------------------------------------------------------------------------------------------------------|------------------------|------------------------------------------------------------------|
| Residual fuel | Total halogen (field screening test, SW-846 Method 9077) | 1 per tank | Not applicable, [REDACTED] will perform the field screening test |
| Residual sludge, sediment, or deleterious material | TPH-diesel (Method 8015M), Toxicity Characteristic Leaching Procedure (TCLP) 8 Resource Conservation and Recovery Act (RCRA) metals (1311/6010B/7470A), Volatile Organic Compound (VOC) (8260B), Polycyclic aromatic hydrocarbons (PAHs) (8270SIM), and Flash Point (7.1.2) | 1 per tank | [REDACTED] |
| Oily water/tank wash water | Total halogen (field screening test, SW-846 Method 9077) | 3 per tank | Not applicable, [REDACTED] will perform the field screening test |
| Ordinary trash | None | None | Not applicable |
| Scrap metal | None | None | Not applicable |

Laboratories providing environmental testing services must be accredited by a nationally recognized and/or DoD recognized laboratory accreditation body (e.g., National Environmental Laboratory Accreditation Program – NELAP, Department of Defense Environmental Laboratory Accreditation Program – DoD ELAP) for the applicable matrix (e.g., solid, water, etc.), test method (e.g., EPA 1311, 6010, 7471, 8082 etc.) and analyte (e.g. lead, cadmium, chromium, mercury, polychlorinated biphenyls, etc.) to be tested.

5.0 WASTE PACKAGING

5.1 Waste Packing

Residual water and oily wash water will be pumped into the S-311 fuel oil recovery (FOR) tank located outside of Adit 3 prior to hauling out to disposal/recycling facilities. The oily sludge/sediment and spent PPE/absorbent debris will be packed into 55-gallon open head steel drums with drum liners. All waste containers will remain closed at all times except for when waste is being added or removed.

Ordinary trash will be collected as general refuse in a 15 CY roll-off bin located at the Adit 4 [REDACTED] laydown yard. Ordinary trash typically consists of office waste, which will be packed in plastic garbage bags.

Scrap metal will be collected in a 15 CY roll-off bin located at the Adit 4 [REDACTED] laydown yard. Scrap metal will be recycled at a State of Hawaii approved facility.

All storage tanks and drums will be stored on secondary containment. Equipment to be used for waste packaging includes vacuum truck, pumps, and hoses.

5.2 Waste Labeling and Marking

After packaging, residual water and oily wash water shall be marked as “Oily Water Pending Testing.” Oily Sludge/sediment shall be marked as “Sludge Pending Analytical.” After the waste characterization, each container will be marked and labeled with an appropriate waste marking and U.S. Department of Transportation (DOT) hazardous labels and markings (if hazardous) for transportation. Hazardous waste containers will be marked with a hazardous waste label with generator’s information, date of accumulation, waste codes, manifest number, proper DOT shipping name, and shipping description. Hazardous waste containers will be also labeled with appropriate DOT hazard labels and markings (e.g., Flammable or Class 9, marine pollutants, etc.)

6.0 WASTE TRANSPORTATION

A hazardous waste manifest with Land Disposal Restriction (LDR) notification forms or a non-hazardous waste manifest will be prepared prior to transportation. The manifest with LDR forms or a non-hazardous waste manifest will be submitted by [REDACTED] for obtaining signatures from the Contracting Officer or Representative. After the waste materials have been characterized, packaged, properly labeled, marked, and manifested, they will be loaded onto a shipping truck. The truck will be placarded with appropriate hazard classes in compliance with 49 CFR requirements. Transporters will be licensed and/or permitted for the classification of hazardous waste, universal waste, or used oil being transported in affected jurisdiction(s).

Facilities or subcontractors offering construction waste transport on-site or off-site must ensure that proper shipping orders, bill of lading, manifests, or other shipping documents containing waste diversion information meet requirements of 40 CFR 273 Universal Waste Management, 49 CFR 173 Shippers – General Requirements for Shipments and Packagings, and 49 CFR 178 Specifications for Packaging. Individuals signing manifest or other shipping documents should meet the minimum training requirements.

7.0 TREATMENT AND DISPOSAL

7.1 Treatment/Disposal Facility Selection

Each waste stream will be evaluated to ensure it meets the waste acceptance criteria and packaging requirements for the proposed treatment, storage, and disposal facility (TSDF) prior to transport. Hazardous waste will be transported off-site to a duly permitted hazardous waste TSDF, along with all paperwork. The disposal facility must operate in a compliant manner and meet all applicable federal and state regulations and requirements.

The facility must demonstrate a properly designed system and it must presently operate (and historically have operated) in a manner that controls the types of materials accepted for disposal. Invoices and certificates of disposal will be returned by the TSDF operators verifying that the waste was received and disposed properly. The certificate of disposal will reference the following:

- waste profile sheet number
- manifest number and shipment date
- quantity disposed
- all waste disposed
- disposal facilities (U.S. Environmental Protection Agency [EPA] identification number, name, location, and phone number)
- disposal method
- date of final disposal
- signature of the person responsible for adequate and appropriate disposition of the waste

Table 4 summarizes the anticipated waste recycling/disposal method and facilities.

TABLE 4: WASTE RECYCLE/DISPOSAL METHOD, PROPOSED FACILITIES, AND PROPOSED TRANSPORTERS

| Potential Waste Stream | Disposal Methods | Recycle/Disposal Facilities | Transporters |
|------------------------|-----------------------------------|-----------------------------|--------------|
| Residual fuel | Recovery and recycle, or disposal | [REDACTED] | [REDACTED] |

Procurement sensitive and proprietary information – This information is exempt from disclosure under 5. U.S.C. § 552(b)(4) because it contains proprietary and procurement sensitive information.

| Potential Waste Stream | Disposal Methods | Recycle/Disposal Facilities | Transporters |
|--------------------------------|---------------------------------------------------------------------|-----------------------------|--------------|
| | | [REDACTED] | [REDACTED] |
| Oily water | Treatment and recycle | [REDACTED] | [REDACTED] |
| Oily sludge/sediment | If hazardous with heavy metal, it will be stabilized and landfilled | [REDACTED] | [REDACTED] |
| | If non-hazardous, it will be solidified and landfilled | [REDACTED] | [REDACTED] |
| Spent PPE and absorbent debris | If hazardous with heavy metal, it will be stabilized and landfilled | [REDACTED] | [REDACTED] |
| | If non-hazardous, it will be solidified and landfilled | [REDACTED] | [REDACTED] |

Distribution authorized to U.S. Government Agencies only;
Other requests shall be referred to NAVFAC HI.

Procurement sensitive and proprietary information – This information is exempt from disclosure under 5. U.S.C. § 552(b)(4) because it contains proprietary and procurement sensitive information.

| Potential Waste Stream | Disposal Methods | Recycle/Disposal Facilities | Transporters |
|------------------------|--------------------------|-----------------------------|--------------|
| Ordinary trash | Burn for energy recovery | [REDACTED] | [REDACTED] |
| Scrap metal | Recycled for reuse | [REDACTED] | [REDACTED] |

8.0 WASTE DOCUMENTATION

██████████ will prepare and process waste disposal documentation in accordance with the procedures for on-island or off-island disposal of non-hazardous waste and off-island disposal of hazardous waste per the details of this Waste Management Plan.

The ██████████ Waste Coordinators will prepare the hazardous and non-hazardous waste documentation for review and signature by authorized government personnel, unless otherwise specified. Documentation will include the following, as applicable:

- Waste profile sheets (forms supplied by the destination TSDF with supporting waste documentation (material safety data sheet, analysis)
- Permit from TSDF accepting waste for disposal as supplied on the waste profile sheet
- Hazardous waste manifests, as required
- Non-hazardous waste manifests or bills of lading, as required
- Land disposal restriction notification/certifications (forms supplied by TSDFs), as required
- Review Sheet for Waste Characterization and Disposal (Naval Facilities Engineering Systems Command [NAVFAC] Environmental Department)
- Waste Documentation Form CNRH N465 (NAVFAC Environmental Department)

8.1 Hazardous and Non-Hazardous Waste Shipment Documentation Procedures

Before allowing a manifested hazardous or non-hazardous waste to leave the property, the following procedures must be followed:

- Government-authorized personnel must sign the uniform hazardous waste manifest or a non-hazardous waste manifest.
- All containers must be properly packaged, marked, labeled, and placarded in accordance with DOT 49 CFR 171 regulations, Resource Conservation and Recovery Act (RCRA), or Toxic Substance Control Act (TSCA) requirements (if applicable). As hazardous material shipment off-site in quantities that require placarding are not currently anticipated, a hazardous materials security plan is not required. The initial waste transporter must sign and print the date of acceptance on the manifest.
- One copy of the uniform hazardous waste manifest, or non-hazardous waste manifest, must be pulled as the generator copy after the initial waste transporter signs the manifest.
- The remaining copies of the uniform hazardous waste manifest, or non-hazardous waste manifest, must be given to the transporter, along with the land disposal restriction certifications, if required.

8.2 Exception Reports

Each waste stream and/or shipment will be tracked from the time it leaves the site until the waste is received and disposed at the Final TSDF. If a signed copy of the original terminal manifest is not received by the 35th day after the original transporter signature, the waste coordinator will contact the TSDF and/or transporters to obtain the status of the waste. If the signed copy is not received by the 45th day after original transporter signature, an EPA exception report must be filed. The exception report draft will be submitted to the [REDACTED]/Government no later than the 37th day, and then forwarded to the EPA by [REDACTED]/Government on or by the 45th day. All calls or other efforts undertaken to locate shipments must be documented along with the exception report.

8.3 Discrepancy Reports

Discrepancies due to differences between the quantities of hazardous waste designated on the manifest or shipping papers and the quantity of hazardous waste a facility actually received will be reported to the [REDACTED]/Government and rectified within 15 days after the TSDF receives the waste. An EPA discrepancy report will be submitted by the [REDACTED] and/or Government representative at least five days before the EPA requires it.

8.4 Recordkeeping

In accordance with Title 40 CFR 262.40, records of signed manifest shall be maintained by the generator for three years or until a signed copy from the designated facility which received the waste is provided.

All waste accumulated shall be logged within the appropriate site accumulation log. Information tracked shall include individual log number, accumulation start date, quantity, description, manifest number, and be initialed by the Waste Coordinator logging the waste.

9.0 WASTE MANAGEMENT

If waste or unused material is determined to be a RCRA hazardous waste or acute hazardous waste, on-site management of the waste must comply with the following hazardous waste management standards such as labeling and marking, container selection and use, and storage and accumulation requirements specified in 40 CFR 260-279.

As stated in the Closure Plan, non-hazardous solid waste will be managed in a similar fashion as hazardous as a best management practice.

9.1 Containers and Labeling

The container and labeling requirements for hazardous waste are summarized below:

- Place all hazardous waste into appropriate United Nations-specification, DOT-approved containers that are compatible with the waste. Ensure the weight limitations for the containers (i.e., drums, super sacks, tri-wall boxes, or roll-off type containers) are not exceeded.
- The containers must be in good condition. If a container is not in good condition or begins to leak, the waste must be transferred to a container that is in good condition.
- Label each container with a hazardous waste label and hazard class DOT label (or placard for bulk containers such as roll-offs or Conex boxes) so they are clearly visible. Supply all information requested on the label including the state/EPA identification number, the generator's name and address, the manifest document number, and the DOT proper shipping description.
- Uncharacterized wastes pending sample results must be marked, "This Container on Hold Pending Analysis." They should also be marked with the date of sampling, the sample identification number, and its suspected hazard class (flammable, corrosive, etc.).
- Containers must remain closed at all times, except when it is necessary to add or remove waste.
- Incompatible wastes must not be placed in the same container or placed in an unwashed container that previously held incompatible waste.
- Containers holding waste that is incompatible (flammable, reactive, etc.) with any waste or materials stored nearby in other containers or piles must be separated from the other materials or protected from them by a dike, berm, wall, or other device.
- If the container will not be used again after disposal, the container must be legally empty. This means that all wastes are removed using practices commonly employed to remove materials from that type of container and no more than 1 inch of waste or less than 3 percent of the total capacity of the container for containers less than 100 gallons.

9.2 Container Selection, Management, and Secondary Containment

All hazardous waste generated on site shall be packaged and shipped in accordance with Hazardous Materials Transportation Act and Regulations (49 CFR 171-180).

Container Selection - Containers shall be:

- Inspected prior to use to ensure they are in good condition. Containers that are not in good condition (leaky, rusted, severely dented, or lids or bungs damaged) will not be used.
- Evaluated prior to use to determine if the container is compatible with the waste. Incompatible containers will not be used to contain any wastes.
- DOT approved (e.g., United Nations-specified drums, super sacks, conex boxes, or roll off type containers).
- Verified to be properly rated for weight of waste to be contained.

Container Management – Container shall be:

- Inspected every 7 days while in use to ensure they are in good condition. Closed at all times, except when waste is being added or removed. Liquid containers will be closed and secured. Solid waste containers will have snug-fitting lids.
- Re-used only for the same waste streams, except uncontaminated overpack containers.
- Positioned so that labels are clearly visible and properly completed. Stored so that adequate aisle space is maintained between each row of containers.
- Allowed 4 to 6 inches of freeboard headspace in liquid drums for expansion of the liquids within the drum during transit.
- Secondary containment required when accumulating: a liquid, flammable liquid, or reactive waste.
- All drums must be placed fully over secondary containment and protected from rain. A covered containment must hold 110 percent of the volume of largest container. An uncovered area also has to have the capacity to hold 13 inches of rainfall in addition to holding 10% of the volume of all containers or 110 percent the volume of the largest container.

9.3 Accumulation Areas

This section provides a summary of the various accumulation area requirements that may be encountered during the project.

Less Than 90-day Accumulation

Contractor shall establish a less than 90-day accumulation site for wastes expected to be characterized as hazardous waste if the hazardous waste in excess of 55 gallons (or 1 quart if acute hazardous waste) cannot be removed from the site within 3 calendar days. Notify the Contracting Officer of the need to establish a less than 90-day accumulation site. Approval by the Contracting Officer is required prior to establishing a 90-day accumulation site. At least 10 working days prior to accumulating waste, submit a request in writing to the Contracting Officer and provide the following information: contract number; contractor; hazardous waste or regulated waste POC; phone number; type of waste, source of waste, emergency POC; phone number; location of the site; site plan.

Contractor shall follow 40 CFR 260-268 requirements for less than 90-day accumulation sites which include, but are not limited to: personnel training, weekly inspections, contingency plan, access to communications or alarm system, arrangements with local authorities. These requirements shall be in place prior to using a less than 90-day accumulation site. Requirements for a less than 90-day accumulation site are significantly more stringent and labor intensive than for a satellite accumulation area. Planning ahead by preparing disposal paperwork and contacting waste transporters can minimize the need for a less than 90-day accumulation site.

Satellite Accumulation Areas

A satellite accumulation area (SAA) shall be designated in areas where hazardous or suspected hazardous wastes are generated and accumulated on-site. The SAA shall be at or near the point of generation and under the control of the operator. Once an SAA exceeds a maximum of 55 gallons of hazardous waste or 1 quart of acute hazardous waste, the waste containers shall be labeled with the accumulation start date (ASD). When over 55 gallons of HW, 1 quart of liquid acute HW, or 2.2 lbs of solid acute HW is expected, contractor shall take appropriate, timely actions (such as scheduling and expediting waste pickup and HW manifest preparation and review) prior to generating waste. Do not generate in excess of 55 gallons of HW, 1 quart of liquid acute HW, or 2.2 lbs of solid acute HW until a waste pickup date is scheduled that will comply with the 3-day regulatory limit. Contractor shall provide manifest/waste documentation for Government review at least 10 working days prior to scheduled pickup date.

Contractor shall follow 40 CFR 262 requirements for SAAs that include, but are not limited to, the requirements in Table 5 and the following:

- The area must be marked clearly with —No Smoking or other appropriate warning signs and a sign that designates it as an SAA.
- The waste must be stored in a manner consistent with the inspection log requirements.
- The amount of waste in excess of 55 gallons of hazardous waste and 1 quart of acute hazardous waste shall be removed from the SAA within 3 days of the accumulation start date.

TABLE 5: LESS THAN 90-DAY CENTRAL ACCUMULATION AREA REQUIREMENTS

| | |
|----------------------------------------------------------|---------------------------------------------------------------------------------------------------------------------------------------------------------------------------------------------------------------------------------------------------------------------------------------------------------------------------------------------------------------------------------------------------------------------------------------------------------------------------------------------------------------------------------------------------------------------------------------------------------------------------------------------------------------------------------------------------------------------------------------------------------------------------------------------------------------------------------------------------------------------------------------------------------------------------------------------------------------------------------------------------------------------------------------------------------------------------------------------------------------------------------------------------------------------------------------------------------------------------------------------------------------------------------------------------------------------------------------------------------------------------------------------------------------------------------------------------------------------------------------------------------------------------------------------------------------------------------------------------------------------------------------------------------------------------------------------------------------------------------------------------------------------------------------------------------------------------------------------------------------------------------------------------------------------------------------------------------------------------------------------------------------------------------------------------------------------------------------------------------------------------------------------------------------------------------------------------------------------------------------------------------------------------------------------------------------------------------------------------------------------------------------------------------------------------------------------------------------------------------------------------------------------------------------------------------------------------------------------------|
| <p>Less Than 90-Day Central Accumulation Area</p> | <p>The following procedures apply in the event a waste is characterized as hazardous waste and a CAA must be established:</p> <ul style="list-style-type: none"> • Establish a less than 90-day accumulation area. • Use the area only for storage of waste and not for storing nonrelated materials, equipment, or functions. • CAA must be located at least 50 feet from property line and secure against unauthorized access. • Located on surface which does not show any cracks or gaps and is impervious to the hazardous waste being stored. • Follow container requirements. • Post the emergency spill response procedures and have a spill kit in the area. • Spill kits shall at a minimum contain the necessary equipment and material to respond to a release of the accumulated waste within an accumulation area. Included contents of the spill kit may consist of: absorbent pads and booms, absorbent granules, PPE (i.e., goggles, gloves, tyvek), trash bags, 5-gal bucket, broom and dust pan, shovel, duct tape, and caution tape. • Keep a fire extinguisher in the area. • Make an emergency shower/eyewash station immediately available, tested weekly, and functioning. • Maintain adequate aisle space and position labels so they are visible and properly labeled. • Secure access to the accumulation area when authorized personnel are not present. • If the less than 90-day accumulation area is not covered, secondary containment for all containers is mandatory and must be capable of containing 10 percent of the volume of all containers or the entire volume of the largest container, plus freeboard for rainwater accumulations. • Post HAZARDOUS WASTE ACCUMULATION AREA and DANGER UNAUTHORIZED PERSONNEL KEEP OUT signs at the entrance. • Conduct inspections every seven days using the 90-day weekly inspection logs. Copies of these inspections will be maintained in the project files. Keep a logbook that includes the date, time, findings, actions taken, and inspector's signature. • Post “NO SMOKING” OR “OPEN FLAME” signs. • Remove or decontaminate all containers, liners, and soil prior to closure. • A roll off container that contains bulk hazardous waste must be managed as a 90- day accumulation area because the volume capacity is greater than 55 gallons. A lined super sack is considered in secondary containment as long as the liner is intact. |
|----------------------------------------------------------|---------------------------------------------------------------------------------------------------------------------------------------------------------------------------------------------------------------------------------------------------------------------------------------------------------------------------------------------------------------------------------------------------------------------------------------------------------------------------------------------------------------------------------------------------------------------------------------------------------------------------------------------------------------------------------------------------------------------------------------------------------------------------------------------------------------------------------------------------------------------------------------------------------------------------------------------------------------------------------------------------------------------------------------------------------------------------------------------------------------------------------------------------------------------------------------------------------------------------------------------------------------------------------------------------------------------------------------------------------------------------------------------------------------------------------------------------------------------------------------------------------------------------------------------------------------------------------------------------------------------------------------------------------------------------------------------------------------------------------------------------------------------------------------------------------------------------------------------------------------------------------------------------------------------------------------------------------------------------------------------------------------------------------------------------------------------------------------------------------------------------------------------------------------------------------------------------------------------------------------------------------------------------------------------------------------------------------------------------------------------------------------------------------------------------------------------------------------------------------------------------------------------------------------------------------------------------------------------------|

TABLE 6: SATELLITE ACCUMULATION AREA (SAA) REQUIREMENTS

| | |
|------------------------------------|----------------------------------------------------------------------------------------------------------------------------------------------------------------------------------------------------------------------------------------------------------------------------------------------------------------------------------------------------------------------------------------------------------------------------------------------------------------------------------------------------------------------------------------------------------------------------------------------------------------------------------------------------------------------------------------------------------------------------------------------------------------------------------------------------------------------------------------------------------------------------------------------------------------------------------------------------------------------------------------------------------------------------------------------------------------------------------------------------------------------------------------------------------------------------------------------------------------------------------------------------------------------------------------------------------------------------------------------------------------------------------------------------------------------------------------------------------------------------------------------------------------------------------------------------------------------------------------------------------------------------------------------------------------------------------------------------------------------------------------------------------------------------------------------------------------------------------------------------------------------------------------------------------------------------------------------------------------------------------------------------------------------------------------------------------------------------------------------------------------------------|
| Satellite Accumulation Area | <p>The following procedures apply in the event an SAA is needed:</p> <ul style="list-style-type: none"> • Use the area only for storage of waste and not for storing nonrelated materials, equipment, or functions. • SAA shall be located at or near the point of generation where wastes initially accumulate. • Follow all container requirements specified above. The container must be marked with the contents and labeled as appropriate with a hazardous waste label and appropriate DOT label. All labels should be on the upper one-third of the container, where practicable. • Post the emergency spill response procedures and have a spill kit nearby. • Spill kits shall at a minimum contain the necessary equipment and material to respond to a release of the accumulated waste within an accumulation area. Included contents of the spill kit may consist of: absorbent pads and booms, absorbent granules, PPE (i.e., goggles, gloves, tyvek), trash bags, 5-gal bucket, broom and dust pan, shovel, duct tape, and caution tape • Keep a fire extinguisher at the area or nearby if any of the waste is flammable. • Make sure emergency shower/eyewash stations are immediately available, tested weekly, and functioning. • Ensure the SAA is secured to prevent improper mixing or unauthorized addition of waste to the containers. • Conduct weekly inspections using the SAA inspection logs. Keep a logbook that includes the date, time, findings, actions taken, and inspector’s signature. • Post “HAZARDOUS WASTE ACCUMULATION AREA” signs so they are visible from a distance of 25 feet. • When 55 gallons or more of a hazardous waste stream or 1 quart of acutely hazardous waste is present in an SAA, fill in the start date on the hazardous waste label and transfer all waste of that particular waste stream to a 90-day accumulation area within 3 days from the start date. • Remove or decontaminate all containers, liners, and waste prior to closure. |
|------------------------------------|----------------------------------------------------------------------------------------------------------------------------------------------------------------------------------------------------------------------------------------------------------------------------------------------------------------------------------------------------------------------------------------------------------------------------------------------------------------------------------------------------------------------------------------------------------------------------------------------------------------------------------------------------------------------------------------------------------------------------------------------------------------------------------------------------------------------------------------------------------------------------------------------------------------------------------------------------------------------------------------------------------------------------------------------------------------------------------------------------------------------------------------------------------------------------------------------------------------------------------------------------------------------------------------------------------------------------------------------------------------------------------------------------------------------------------------------------------------------------------------------------------------------------------------------------------------------------------------------------------------------------------------------------------------------------------------------------------------------------------------------------------------------------------------------------------------------------------------------------------------------------------------------------------------------------------------------------------------------------------------------------------------------------------------------------------------------------------------------------------------------------|

9.4 Disposal

Hazardous waste disposal is described in Section 6.

9.5 Procedures for Handling Rejected Load of Hazardous Waste

If a load of hazardous waste is rejected from the TSDF, immediately notify the project manager. This notification should occur as soon as anyone becomes aware of the load rejection. The notification must include a contact name and number for someone who is aware of the waste and the reason for rejection.

The project manager will immediately notify the Government Contracting Officer. The following information will be provided:

- manifest number
- generator of manifest
- the date of waste rejection
- who rejected the waste at the TSDF (include contact name/telephone number)
- the reason for waste rejection
- where the waste is located

A rejected load of hazardous waste, if [REDACTED] is the generator, will need to be coordinated by [REDACTED] to be delivered back onsite due to the remote location and site access restrictions. In the event a load is returned, [REDACTED] may request to establish a CAA as a temporary holding location. CAA establishment shall follow all applicable regulations and must conform to this Waste Management Plan.

Immediate notification of the NTR should occur even if all the information is not available. However, the information should be obtained and transmitted to the [REDACTED]/Government as soon as possible. After notification, proceed with the technical direction from the [REDACTED]/Government representative.

9.6 Hazardous Material (including waste) Transportation

Hazardous material (including wastes) must be shipped in accordance with DOT requirements. Hazardous material transported on U.S. land and in U.S. waters must be properly classed, described, packaged, marked, and labeled for shipment as required by the DOT Hazardous Materials Regulations 49 CFR 171. All DOT functions must be performed by properly trained personnel, as discussed in Section 5.0.

Requirements under 49 CFR 171 will apply to all off-site shipments of hazardous materials. The definition of hazardous materials includes hazardous wastes. Personnel trained under hazardous materials 126-F requirements will perform all DOT functions. The information contained in this section is intended to be a general guide. Requirements specific to each hazardous material must be determined in the field. It is the responsibility of each DOT-trained individual to ensure the requirements of 49 CFR 171 are met. The Waste Coordinator will verify DOT requirements are met before the waste shipment leaves the site. Any issues or questions regarding the proper shipment of hazardous materials are to be directed to the waste coordinator.

9.7 On-island or Off-Island Disposal of Non-Hazardous Waste

Before transporting any non-hazardous construction and/or demolition debris and waste off Government Property, submit the waste documentation package including laboratory results, lab accreditation package, Waste Documentation Form, Additional Information for Construction and Demolition Waste form, and Review Sheet for Waste Characterization and Disposal to the Installation Environmental Office via the Contracting Officer.

Procurement sensitive and proprietary information – This information is exempt from disclosure under 5. U.S.C. § 552(b)(4) because it contains proprietary and procurement sensitive information.

Comply with Department of Transportation (DOT) regulations and implement applicable DOT requirements (e.g., proper shipping name, packaging, marking, labeling, placarding, Commercial Driver License with Hazardous Material endorsement, and non-hazardous waste manifest). Prepare the required shipping papers in accordance with DOT regulations, to include proper certification statement required by 49 CFR 172.204(a), and submit to the Installation Environmental Office via Contracting Officer. Allow 10 working days for Government review. Once Government comments are adequately addressed, Installation Environmental Office staff will sign the appropriate waste documentation as the Generator/Property Owner.

For non-DOT regulated, non-hazardous waste, prepare and sign any additional documentation similar to a non-hazardous waste manifest when required by the waste disposal facility.

9.8 Off-Island Disposal of Hazardous Waste

Dispose of hazardous waste at permitted off-island treatment, storage, and disposal facility. Before transporting hazardous waste off Government property, submit hazardous waste manifest, land disposal restriction (LDR) form as applicable, laboratory results, lab accreditation package, Waste Documentation Form, Additional Information for Construction and Demolition Waste form, and Review Sheet for Waste Characterization and Disposal to the Installation Environmental Office via the Contracting Officer. Allow 10 working days for Government review.

The Installation Environmental Office will sign the hazardous waste manifests as the generator. Contractor transporting hazardous waste off Government property must have transporter EPA Identification Number, appropriate DOT training, and appropriate driver's license endorsements required to transport hazardous waste.

10.0 CONTINGENCY PLAN

An unexpected sudden or non-sudden release of any hazardous materials storage and shipped on the site may create a release of hazardous waste to the air, soil or surface water at the facility. As such, the Project Contingency Plan addresses the responsible persons, actions, and emergency equipment required to contain spills and other types of emergency situations, that can be either external threats (natural disasters, hurricane, earthquake) or internal threats (spill, fire, security breach, power outage, etc.)

11.0 REFERENCES

Test Methods for Evaluating Solid Waste, Physical/Chemical Methods, EPA publication SW-846, Third Edition, Final Updates I (1993), II (1995), IIA (1994), IIB (1995), III (1997), IIIA (1999), IIIB (2005), IV (2008), and V (2015).

United States Code of Federal Regulations, 40 CFR Part 171

United States Code of Federal Regulations, 40 CFR Part 261

United States Code of Federal Regulations, 40 CFR Part 262

United States Code of Federal Regulations, 40 CFR Part 279

Procurement sensitive and proprietary information – This information is exempt from disclosure under 5. U.S.C. § 552(b)(4) because it contains proprietary and procurement sensitive information.

Appendix 1

Universal Waste Management Plan

PROCEDURE

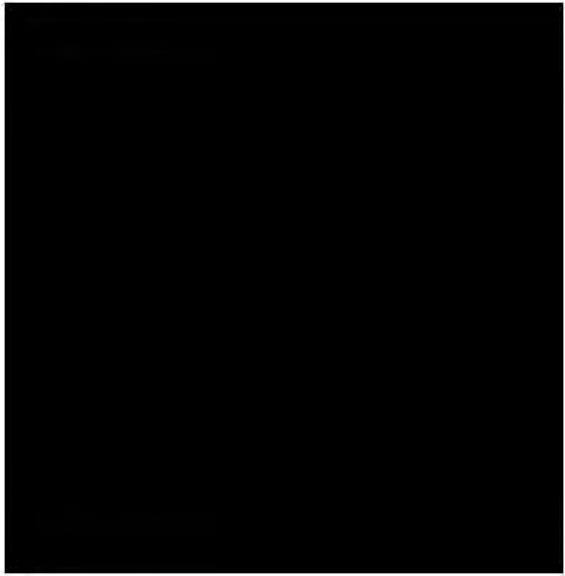
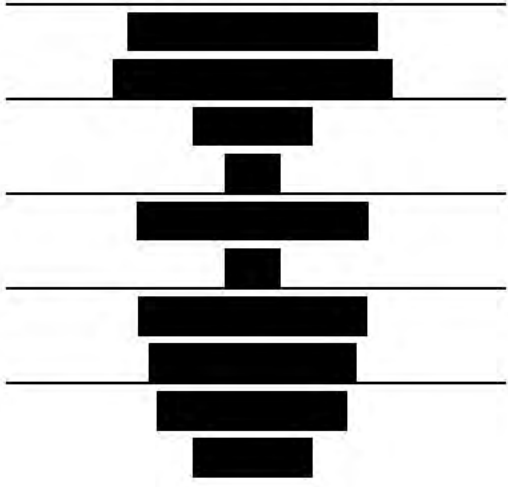

UNIVERSAL WASTE MANAGEMENT

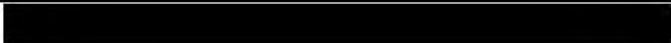



UNIVERSAL WASTE MANAGEMENT

■ [Redacted]

[Redacted]

■ [Redacted]

[Redacted]

■ [Redacted]

[Redacted]

■ [Redacted]

■ [Redacted]

■ [Redacted]

[Redacted]

■ [Redacted]

[Redacted]

■ [Redacted]

■ [Redacted]

■ [Redacted]

■ [Redacted]

■ [Redacted]

■ [Redacted]

UNIVERSAL WASTE MANAGEMENT

[REDACTED]

- [REDACTED]
 - [REDACTED]
 - [REDACTED]
- [REDACTED]
- [REDACTED]
- [REDACTED]
- [REDACTED]
 - [REDACTED]
 - [REDACTED]
 - [REDACTED]
 - [REDACTED]
 - [REDACTED]
 - [REDACTED]
 - [REDACTED]
 - [REDACTED]
- [REDACTED]
- [REDACTED]
- [REDACTED]
- [REDACTED]

Procurement sensitive and proprietary information – This information is exempt from disclosure under 5. U.S.C. § 552(b)(4) because it contains proprietary and procurement sensitive information.

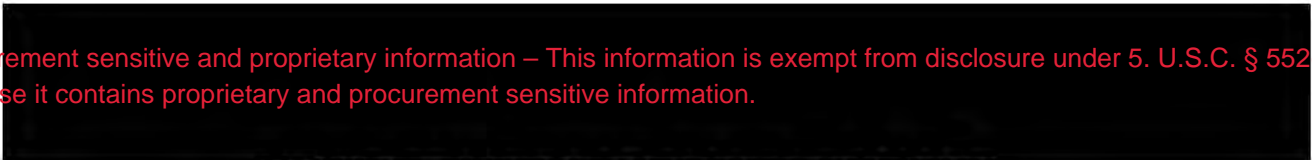

UNIVERSAL WASTE MANAGEMENT

[Redacted]

■ [Redacted]

■ [Redacted]

■ [Redacted]

■ [Redacted]

[Redacted]

■ [Redacted]

■ [Redacted]

■ [Redacted]

■ [Redacted]

■ [Redacted]

■ [Redacted]

■ [Redacted]

■ [Redacted]

■ [Redacted]

■ [Redacted]

■ [Redacted]

■ [Redacted]

■ [Redacted]

UNIVERSAL WASTE MANAGEMENT

[REDACTED]

[REDACTED]

[REDACTED]

[REDACTED]

[REDACTED]

[REDACTED]

[REDACTED]

[REDACTED]

[REDACTED]

[REDACTED]

[REDACTED]

[REDACTED]

[REDACTED]

[REDACTED]

[REDACTED]

[REDACTED]

[REDACTED]

[REDACTED]

[REDACTED]

UNIVERSAL WASTE MANAGEMENT

-
- [Redacted]
 - [Redacted]
 - [Redacted]
 - [Redacted]
 - [Redacted]
 - [Redacted]
 - [Redacted]
 - [Redacted]
 - [Redacted]
 - [Redacted]
 - [Redacted]

| [Redacted] | [Redacted] |
|------------|------------|
| [Redacted] | [Redacted] |
| [Redacted] | [Redacted] |

UNIVERSAL WASTE MANAGEMENT

| | |
|------------|------------|
| [REDACTED] | [REDACTED] |
| [REDACTED] | [REDACTED] |
| [REDACTED] | [REDACTED] |
| [REDACTED] | [REDACTED] |
| [REDACTED] | [REDACTED] |
| [REDACTED] | [REDACTED] |
| [REDACTED] | [REDACTED] |
| [REDACTED] | [REDACTED] |
| [REDACTED] | [REDACTED] |
| [REDACTED] | [REDACTED] |
| [REDACTED] | [REDACTED] |
| [REDACTED] | [REDACTED] |
| [REDACTED] | [REDACTED] |
| [REDACTED] | [REDACTED] |
| [REDACTED] | [REDACTED] |
| [REDACTED] | [REDACTED] |
| [REDACTED] | [REDACTED] |
| [REDACTED] | [REDACTED] |

UNIVERSAL WASTE MANAGEMENT

| | |
|------------|------------|
| [REDACTED] | [REDACTED] |
| [REDACTED] | [REDACTED] |
| [REDACTED] | [REDACTED] |
| [REDACTED] | [REDACTED] |
| [REDACTED] | [REDACTED] |
| [REDACTED] | [REDACTED] |
| [REDACTED] | [REDACTED] |
| [REDACTED] | [REDACTED] |
| [REDACTED] | [REDACTED] |
| [REDACTED] | [REDACTED] |

Procurement sensitive and proprietary information – This information is exempt from disclosure under 5. U.S.C. § 552(b)(4) because it contains proprietary and procurement sensitive information.

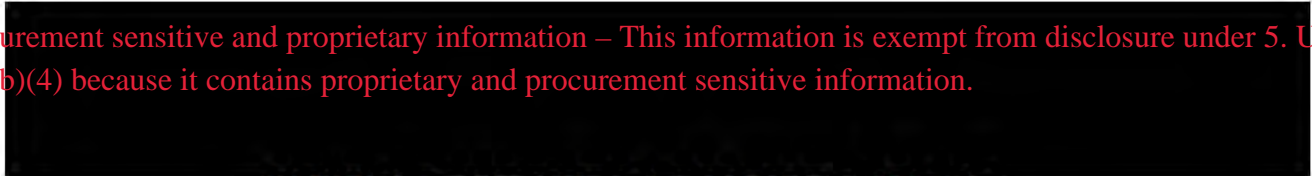

UNIVERSAL WASTE MANAGEMENT

| | | | |
|---|------------|------------|--|
| ■ | [Redacted] | | |
| ■ | [Redacted] | | |
| | | | |
| ■ | [Redacted] | | |
| | [Redacted] | [Redacted] | |
| | [Redacted] | [Redacted] | |
| | [Redacted] | [Redacted] | |
| | [Redacted] | [Redacted] | |
| | [Redacted] | [Redacted] | |
| | [Redacted] | [Redacted] | |
| | [Redacted] | [Redacted] | |
| ■ | [Redacted] | | |
| | [Redacted] | [Redacted] | |
| | [Redacted] | [Redacted] | |
| | [Redacted] | [Redacted] | |
| ■ | [Redacted] | | |
| | [Redacted] | [Redacted] | |
| | [Redacted] | [Redacted] | |

Procurement sensitive and proprietary information – This information is exempt from disclosure under 5. U.S.C. § 552(b)(4) because it contains proprietary and procurement sensitive information.

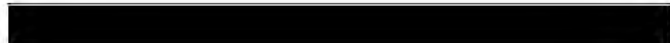

UNIVERSAL WASTE MANAGEMENT

Example Universal Waste Labels

Examples of Universal Waste labels that are available for use.

A purple rectangular label with the text "UNIVERSAL WASTE" in large white letters at the top. Below this, there are four horizontal lines for text, each preceded by a label: "CONTENTS", "ACCUMULATION START DATE", "SHIPPER", "ADDRESS", and "CITY, STATE, ZIP".

A purple rectangular label with "UNIVERSAL WASTE" at the top. On the left side, there are four horizontal lines for text, each preceded by a label: "SHIPPER", "ADDRESS", "CITY, STATE, ZIP", and "ACCUMULATION START DATE". On the right side, the text "USED BATTERIES" is written in white.

A brown rectangular label with "USED BATTERIES" written in white, slanted, large letters at the top. Below this, there are four horizontal lines for text, each preceded by a label: "SHIPPER", "ADDRESS", "CITY, STATE, ZIP", and "CONTENTS". At the bottom, "USED BATTERIES" is written again in white.

A purple rectangular label with "UNIVERSAL WASTE" at the top. On the left side, there are four horizontal lines for text, each preceded by a label: "SHIPPER", "ADDRESS", "CITY, STATE, ZIP", and "ACCUMULATION START DATE". On the right side, the text "USED LAMPS" is written in white.

ATTACHMENT 7: TANK 1 HYDROTEST WATER LAB ANALYSIS

[RETURN TO TABLE OF CONTENTS](#)



January 7, 2022

Pacific Commercial Services, LLC
PO Box 235117
Honolulu, HI
96823

Dear Daniel Barragan:

Please find enclosed the analytical report for:

| | |
|----------------|--------------------------------|
| Project Name: | Aptim Red Hill Hydrotest water |
| AAL Project#: | X7 |
| Date Received: | 01/04/2022 |
| MIS Prep: | No |

The results, applicable reporting limits, QA/QC data, invoice, and copy of COC are included.

Advanced Analytical Laboratory appreciates the opportunity to provide analytical services for this project. If you have any questions regarding this project, please don't hesitate to contact AAL.

Thank you for your business and continuing support.

Sincerely,

Uwe Baumgartner, Ph.D
Owner

Elisa M. Young
Owner

544 Ohohia St. Unit 10, HONOLULU HAWAII 96819
tel (808) 836-2252



AAL Project #X7

Pacific Commercial Services, LLC

Client Project #: 303472-01 Method 8015M
 Client Project Name: Aptim Red Hill Hydrotest water Matrix: Water

| CLIENT SAMPLE ID | TPH-DIESEL [mg/L] | TPH-OIL [mg/L] | SURROGATE RECOVERY | FLAGS | DATE ANALYZED |
|------------------|-------------------|----------------|--------------------|-------|---------------|
| Blank | nd | nd | 96% | | 1/6/2022 |
| Tank 01 | 0.108 | nd | MI | | 1/6/2022 |
| PQL | 0.050 | 0.100 | Acceptable Range | | |
| MDL | 0.010 | 0.032 | 70%-130% | | |

QA/QC DATA

| QC BATCH # | TPH-DIESEL [mg/L] | TPH-OIL [mg/L] | Acceptable Range |
|-------------------------|-------------------|----------------|------------------|
| 010622 | | | |
| Lab Control Spike (LCS) | 0.492 | 0.472 | 0.350-0.650 |
| Matrix Spike (MS) | 0.497 | 0.479 | 0.350-0.650 |
| Matrix Spike Dup (MSD) | 0.496 | 0.476 | 0.350-0.650 |
| Recovery LCS | 98% | 94% | 70%-130% |
| Recovery MS | 99% | 96% | 70%-130% |
| Recovery MSD | 99% | 95% | 70%-130% |
| RPD of MS/MSD | 0.2% | 0.6% | 20% |

Analyst: U. Baumgartner, Ph.D.
 Data review: E. Young



12524 130th Lane NE
Kirkland WA 98034

Tel: (425) 214-5858
(425) 214-5868
Email: lisa@accu-lab.com
website: www.accu-lab.com

Analytical Report

| | | |
|------------------------|---------------------------------------------------------------------------------------|--------------------------------|
| Client | Advanced Analytical Laboratory 544 Ohohia Street #10 Honolulu, HI, 96819 | Acculab WO# 22-AL0106-4 |
| Project Manager | Uwe Baumgartner/ Elisa Young | Date Sampled 1/4/2022 |
| Project Name | Aptim Red Hill Hydrotest water | Date Received 1/6/2022 |
| Client Project# | 303472-01 | Date Reported 1/7/2022 |
| Project# | X7 | |

TPH-GRO in Water by EPA 8260D/5030B

Accu Lab Batch# AL010622-1

| Client sample ID | | | Tank 01 | MS | MSD | RPD | | |
|-------------------------------|------|------|----------|----------|---------------|---------------|---------------|---------------|
| Lab ID | MRL | Unit | MTH BLK | LCS | 22-AL0106-4-1 | 22-AL0106-0-1 | 22-AL0106-0-1 | 22-AL0106-0-1 |
| Matrix | | | Water | Water | Water | Liquid | Liquid | Liquid |
| Date Analyzed | | | 1/6/2022 | 1/6/2022 | 1/6/2022 | 1/6/2022 | 1/6/2022 | 1/6/2022 |
| Gasoline Range Organics (GRO) | 0.25 | mg/l | nd | 95% | nd | 103% | 95% | 8% |
| Surrogate Recoveries | | | | | | | | |
| Dibromofluoromethane | | | 87% | 85% | 85% | 81% | 83% | |
| 4-Bromofluorobenzene | | | 90% | 89% | 90% | 88% | 85% | |

Acceptable Recovery Limits:
 Surrogates/LCS 70-130%
 MS/MSD 65-135%
 Acceptable RPD limit: 30%

*This report is issued solely for the use of the person or company to whom it is addressed.
 Any use, copying or disclosure other than by the intended recipient is unauthorized.*



12524 130th Lane NE
Kirkland WA 98034

Tel: (425) 214-5858
(425) 214-5868
Email: lisa@accu-lab.com
website: www.accu-lab.com

Analytical Report

| | | | |
|-----------------|--------------------------------------------------------------------------------|---------------|-------------|
| Client | Advanced Analytical Laboratory 544 Ohohia Street #10 Honolulu, HI, 96819 | Acculab WO# | 22-AL0106-4 |
| Project Manager | Uwe Baumgartner/ Elisa Young | Date Sampled | 1/4/2022 |
| Project Name | Aptim Red Hill Hydrotest water | Date Received | 1/6/2022 |
| Client Project# | 303472-01 | Date Reported | 1/7/2022 |
| Project# | X7 | | |

Volatiles in Water by EPA 8260C/5030B

Accu Lab Batch# AL010622-1

| Client sample ID | | | | | Tank 01 | MS | MSD | RPD |
|-----------------------------|-----|------|----------|----------|---------------|---------------|---------------|---------------|
| Lab ID | MRL | Unit | MTH BLK | LC S | 22-AL0106-4-1 | 22-AL0106-0-1 | 22-AL0106-0-1 | 22-AL0106-0-1 |
| Matrix | | | Water | Water | Water | Liquid | Liquid | Liquid |
| Date Analyzed | | | 1/6/2022 | 1/6/2022 | 1/6/2022 | 1/6/2022 | 1/6/2022 | 1/6/2022 |
| Chloromethane | 2.0 | ug/l | nd | | nd | | | |
| Vinyl chloride | 2.0 | ug/l | nd | 81% | nd | 77% | 76% | 2% |
| Bromomethane | 2.0 | ug/l | nd | | nd | | | |
| Chloroethane | 2.0 | ug/l | nd | | nd | | | |
| Trichlorofluoromethane | 2.0 | ug/l | nd | | nd | | | |
| 1,1-Dichloroethene | 2.0 | ug/l | nd | | nd | | | |
| Methylene Chloride | 2.0 | ug/l | nd | | nd | | | |
| Methyl T-Butyl Ether (MTBE) | 0.5 | ug/l | nd | 76% | nd | 78% | 80% | 3% |
| trans-1,2-Dichloroethene | 1.0 | ug/l | nd | | nd | | | |
| 1,1-Dichloroethane | 1.0 | ug/l | nd | 78% | nd | 80% | 79% | 2% |
| 2,2-Dichloropropane | 1.0 | ug/l | nd | | nd | | | |
| cis-1,2-Dichloroethene | 1.0 | ug/l | nd | | nd | | | |
| Methyl Ethyl Ketone (MEK) | 1.0 | ug/l | nd | | nd | | | |
| Chloroform | 1.0 | ug/l | nd | | nd | | | |
| 1,1,1-Trichloroethane | 1.0 | ug/l | nd | | nd | | | |
| Carbon tetrachloride | 1.0 | ug/l | nd | | nd | | | |
| 1,1-Dichloropropene | 1.0 | ug/l | nd | | nd | | | |
| Benzene | 0.5 | ug/l | nd | 90% | nd | 92% | 90% | 2% |
| 1,2-Dichloroethane (EDC) | 1.0 | ug/l | nd | | nd | | | |
| Trichloroethene | 1.0 | ug/l | nd | 100% | nd | 103% | 92% | 11% |
| 1,2-Dichloropropane | 1.0 | ug/l | nd | | nd | | | |
| Dibromomethane | 1.0 | ug/l | nd | | nd | | | |
| Bromodichloromethane | 1.0 | ug/l | nd | | nd | | | |
| Toluene | 1.0 | ug/l | nd | 114% | 7.2 | 111% | 109% | 1% |
| 1,1,2-Trichloroethane | 1.0 | ug/l | nd | | nd | | | |
| Tetrachloroethene | 1.0 | ug/l | nd | 123% | nd | 132% | 130% | 2% |
| 1,3-Dichloropropane | 1.0 | ug/l | nd | | nd | | | |
| Dibromochloromethane | 1.0 | ug/l | nd | | nd | | | |
| 1,2-Dibromoethane (EDB) | 1.0 | ug/l | nd | | nd | | | |

*This report is issued solely for the use of the person or company to whom it is addressed.
Any use, copying or disclosure other than by the intended recipient is unauthorized.*



12524 130th Lane NE
Kirkland WA 98034

Tel: (425) 214-5858
(425) 214-5888
Email: lisa@accu-lab.com
website: www.accu-lab.com

Analytical Report

| | | | |
|-----------------|--------------------------------------------------------------------------------|---------------|-------------|
| Client | Advanced Analytical Laboratory 544 Ohohia Street #10 Honolulu, HI, 96819 | Acculab WO# | 22-AL0106-4 |
| Project Manager | Uwe Baumgartner/ Elisa Young | Date Sampled | 1/4/2022 |
| Project Name | Aptim Red Hill Hydrotest water | Date Received | 1/6/2022 |
| Client Project# | 303472-01 | Date Reported | 1/7/2022 |
| Project# | X7 | | |

Volatiles in Water by EPA 8260C/5030B

Accu Lab Batch# AL010622-1

| Client sample ID | Tank 01 | | | | MS | MSD | RPD | |
|-----------------------------|---------|------|----------|----------|---------------|---------------|---------------|---------------|
| Lab ID | MRL | Unit | MTH BLK | LCS | 22-AL0106-4-1 | 22-AL0106-0-1 | 22-AL0106-0-1 | 22-AL0106-0-1 |
| Matrix | | | Water | Water | Water | Liquid | Liquid | Liquid |
| Date Analyzed | | | 1/6/2022 | 1/6/2022 | 1/6/2022 | 1/6/2022 | 1/6/2022 | 1/6/2022 |
| Chlorobenzene | 1.0 | ug/l | nd | 122% | nd | 122% | 120% | 1% |
| 1,1,1,2-Tetrachloroethane | 1.0 | ug/l | nd | | nd | | | |
| Ethyl benzene | 0.5 | ug/l | nd | 108% | nd | 108% | 108% | 0% |
| m,p-Xylenes | 2.0 | ug/l | nd | 126% | 4.9 | 124% | 123% | 1% |
| o-Xylene | 1.0 | ug/l | nd | 122% | 2.6 | 121% | 120% | 1% |
| Styrene | 1.0 | ug/l | nd | | nd | | | |
| Bromoform | 2.0 | ug/l | nd | | 3.5 | | | |
| Isopropyl benzene | 0.5 | ug/l | nd | | nd | | | |
| 1,2,3-Trichloropropane | 1.0 | ug/l | nd | | nd | | | |
| Bromobenzene | 0.5 | ug/l | nd | | nd | | | |
| 1,1,2,2-Tetrachloroethane | 0.5 | ug/l | nd | | nd | | | |
| n-Propylbenzene | 0.5 | ug/l | nd | | nd | | | |
| 2-Chlorotoluene | 0.5 | ug/l | nd | | nd | | | |
| 4-Chlorotoluene | 0.5 | ug/l | nd | | nd | | | |
| 1,3,5-Trimethylbenzene | 0.5 | ug/l | nd | | 2.2 | | | |
| tert-Butylbenzene | 0.5 | ug/l | nd | | nd | | | |
| 1,2,4-Trimethylbenzene | 0.5 | ug/l | nd | | 6.8 | | | |
| sec-Butylbenzene | 0.5 | ug/l | nd | | nd | | | |
| 1,3-Dichlorobenzene | 0.5 | ug/l | nd | | nd | | | |
| p-Isopropyltoluene | 0.5 | ug/l | nd | | nd | | | |
| 1,4-Dichlorobenzene | 0.5 | ug/l | nd | | nd | | | |
| 1,2-Dichlorobenzene | 0.5 | ug/l | nd | | nd | | | |
| n-Butylbenzene | 0.5 | ug/l | nd | | nd | | | |
| 1,2-Dibromo-3-Chloropropane | 2.0 | ug/l | nd | | nd | | | |
| 1,2,4-Trichlorobenzene | 2.0 | ug/l | nd | | nd | | | |
| Hexachlorobutadiene | 2.0 | ug/l | nd | | nd | | | |
| Naphthalene | 2.0 | ug/l | nd | 82% | 11 | 105% | 112% | 7% |
| 1,2,3-Trichlorobenzene | 2.0 | ug/l | nd | | nd | | | |

*This report is issued solely for the use of the person or company to whom it is addressed.
Any use, copying or disclosure other than by the intended recipient is unauthorized.*



12524 130th Lane NE
Kirkland WA 98034

Tel: (425) 214-5858
(425) 214-5868
Email: lisa@accu-lab.com
website: www.accu-lab.com

Analytical Report

| | | | |
|------------------------|---------------------------------------------------------------------------------------|----------------------|--------------------|
| Client | Advanced Analytical Laboratory 544 Ohohia Street #10 Honolulu, HI, 96819 | Acculab WO# | 22-AL0106-4 |
| Project Manager | Uwe Baumgartner/ Elisa Young | Date Sampled | 1/4/2022 |
| Project Name | Aptim Red Hill Hydrotest water | Date Received | 1/6/2022 |
| Client Project# | 303472-01 | Date Reported | 1/7/2022 |
| Project# | X7 | | |

Volatiles in Water by EPA 8260C/5030B

Accu Lab Batch# AL010622-1

| Client sample ID | Tank 01 | | | | MS | MSD | RPD | |
|------------------|---------|------|----------|----------|---------------|---------------|---------------|---------------|
| Lab ID | MRL | Unit | MTH BLK | LCS | 22-AL0106-4-1 | 22-AL0106-0-1 | 22-AL0106-0-1 | 22-AL0106-0-1 |
| Matrix | | | Water | Water | Water | Liquid | Liquid | Liquid |
| Date Analyzed | | | 1/6/2022 | 1/6/2022 | 1/6/2022 | 1/6/2022 | 1/6/2022 | 1/6/2022 |

Surrogate Recoveries

| | | | | | | | | |
|-----------------------|--|--|-----|------|-----|-----|-----|--|
| Dibromofluoromethane | | | 87% | 85% | 85% | 81% | 83% | |
| 1,2-Dichloroethane-d4 | | | 82% | 82% | 78% | 80% | 80% | |
| Toluene-d8 | | | 99% | 101% | 96% | 97% | 99% | |
| 4-Bromofluorobenzene | | | 90% | 89% | 90% | 88% | 85% | |

Acceptable Recovery Limits:

| | |
|-----------------------|---------|
| Surrogates/LCS | 70-130% |
| MS/MSD | 65-135% |
| Acceptable RPD limit: | 30% |

*This report is issued solely for the use of the person or company to whom it is addressed.
Any use, copying or disclosure other than by the intended recipient is unauthorized.*



12524 130th Lane NE
Kirkland WA 98034

Tel: (425) 214-5858
(425) 214-5888
Email: lisa@accu-lab.com
website: www.accu-lab.com

Analytical Report

| | | | |
|------------------------|--------------------------------------------------------------------------------|----------------------|-------------|
| Client | Advanced Analytical Laboratory 544 Ohohia Street #10 Honolulu, HI, 96819 | Acculab WO# | 22-AL0106-4 |
| Project Manager | Uwe Baumgartner/ Elisa Young | Date Sampled | 1/4/2022 |
| Project Name | Aptim Red Hill Hydrotest water | Date Received | 1/6/2022 |
| Client Project# | 303472-01 | Date Reported | 1/7/2022 |
| Project# | X7 | | |

PAHs in Water by 8270D/3010C GC/MS-SIM

Accu Lab Batch# AL010622-5

| Client sample ID | Tank 01 | | | | DUP | RPD | |
|------------------|---------|------|----------|---------------|----------|----------|----------|
| Lab ID | MRL | Unit | MTH BLK | 22-AL0106-4-1 | LCS/MS | LCS/MS | LCS/MS |
| Matrix | | | Water | Water | Water | Water | Water |
| Date Extracted | | | 1/6/2022 | 1/6/2022 | 1/6/2022 | 1/6/2022 | 1/6/2022 |
| Date Analyzed | | | 1/7/2022 | 1/7/2022 | 1/7/2022 | 1/7/2022 | 1/7/2022 |
| Naphthalene | 0.05 | ug/l | nd | 7.4 | 115% | 98% | 16% |
| Acenaphthene | 0.05 | ug/l | nd | 0.12 | 75% | 79% | 6% |
| Fluoranthene | 0.05 | ug/l | nd | nd | 77% | 76% | 1% |
| Benzo(a)pyrene | 0.025 | ug/l | nd | nd | 89% | 87% | 2% |

Surrogate Recoveries

| | | | | |
|------------------|------|------|-----|-----|
| 2-Fluorobiphenyl | 138% | 119% | 88% | 90% |
| Terphenyl-d14 | 108% | 87% | 76% | 77% |

Acceptable Recovery Limits:

| | |
|-----------------------|---------|
| Surrogates/LCS | 50-150% |
| MS/MSD | 50-150% |
| Acceptable RPD Limit: | 15% |

*This report is issued solely for the use of the person or company to whom it is addressed.
Any use, copying or disclosure other than by the intended recipient is unauthorized.*



12524 130th Lane NE
Kirkland WA 98034

Tel: (425) 214-5858
(425) 214-5888
Email: lisa@accu-lab.com
website: www.accu-lab.com

Analytical Report

| | | | |
|------------------------|---------------------------------------------------------------------------------------|----------------------|--------------------|
| Client | Advanced Analytical Laboratory 544 Ohohia Street #10 Honolulu, HI, 96819 | Acculab WO# | 22-AL0106-4 |
| Project Manager | Uwe Baumgartner/ Elisa Young | Date Sampled | 1/4/2022 |
| Project Name | Aptim Red Hill Hydrotect water | Date Received | 1/6/2022 |
| Client Project# | 303472-01 | Date Reported | 1/7/2022 |
| Project# | X7 | | |

Polychlorinated Biphenyls in Water by EPA 8082A/3510C

Accu Lab Batch# AL010622-4

| Client sample ID | Tank 01 | | | | DUP | RPD |
|------------------|---------------|----------|----------|----------|----------|----------|
| | Lab ID | MRL | Unit | MTH BLK | | |
| | 22-AL0106-4-1 | LCS/MS | LCS/MS | LCS/MS | | |
| Matrix | | Water | Water | Water | Water | Water |
| Date Extracted | | 1/6/2022 | 1/6/2022 | 1/6/2022 | 1/6/2022 | 1/6/2022 |
| Date Analyzed | | 1/6/2022 | 1/6/2022 | 1/6/2022 | 1/6/2022 | 1/6/2022 |
| A1016 | 0.10 | ug/l | nd | nd | | |
| A1221 | 0.10 | ug/l | nd | nd | | |
| A1232 | 0.10 | ug/l | nd | nd | | |
| A1242 | 0.10 | ug/l | nd | nd | | |
| A1248 | 0.10 | ug/l | nd | nd | | |
| A1254 | 0.10 | ug/l | nd | nd | | |
| A1260 | 0.10 | ug/l | nd | nd | 93% | 94% |
| A1262 | 0.10 | ug/l | nd | nd | | 0.5% |

Surrogate Recoveries

| | | | | |
|----------------------|------|------|------|------|
| Decachlorobiphenyl | 99% | 78% | 99% | 99% |
| Tetrachloro-m-xylene | 129% | 127% | 117% | 119% |

Acceptable Recovery Limits:
 Surrogates/LCS 60-150%
 MS/MSD 50-150%
 Acceptable RPD limit: 30%

This report is issued solely for the use of the person or company to whom it is addressed. Any use, copying or disclosure other than by the intended recipient is unauthorized.



12524 130th Lane NE
Kirkland WA 98034

Tel: (425) 214-5858
(425) 214-5888
Email: lisa@accu-lab.com
website: www.accu-lab.com

Analytical Report

| | | | |
|------------------------|---------------------------------------------------------------------------------------|----------------------|--------------------|
| Client | Advanced Analytical Laboratory 544 Ohohia Street #10 Honolulu, HI, 96819 | Acculab WO# | 22-AL0106-4 |
| Project Manager | Uwe Baumgartner/ Elisa Young | Date Sampled | 1/4/2022 |
| Project Name | Aptim Red Hill Hydrotest water | Date Received | 1/8/2022 |
| Client Project# | 303472-01 | Date Reported | 1/7/2022 |
| Project# | X7 | | |

Dissolved Metals in Water by EPA 6020B/EPA3005A

Accu Lab Batch# AL010622-10

| Client sample ID | Tank 01 | | | | MS | MSD | RPD | |
|------------------|---------|------|----------|----------|---------------|---------------|---------------|------|
| Lab ID | MRL | Unit | MTH BLK | LCS | 22-AL0106-4-1 | 22-AL0106-4-1 | 22-AL0106-4-1 | |
| Matrix | | | Water | Water | Water | Water | Water | |
| Date Prepared | | | 1/8/2022 | 1/6/2022 | 1/8/2022 | 1/8/2022 | 1/8/2022 | |
| Date Analyzed | | | 1/8/2022 | 1/6/2022 | 1/8/2022 | 1/8/2022 | 1/8/2022 | |
| Antimony (Sb) | 1.0 | ug/l | nd | 101% | 1.7 | 82% | 81% | 0.5% |
| Arsenic (As) | 5.0 | ug/l | nd | 104% | nd | 111% | 110% | 1% |
| Beryllium (Be) | 1.0 | ug/l | nd | 108% | nd | 101% | 100% | 1% |
| Cadmium (Cd) | 1.0 | ug/l | nd | 103% | nd | 96% | 96% | 0.8% |
| Chromium (Cr) | 2.0 | ug/l | nd | 104% | nd | 97% | 96% | 1% |
| Copper (Cu) | 5.0 | ug/l | nd | 104% | nd | 88% | 88% | 0.5% |
| Lead (Pb) | 1.0 | ug/l | nd | 112% | nd | 101% | 102% | 1% |
| Nickle (Ni) | 1.0 | ug/l | nd | 104% | 7.6 | 95% | 94% | 1% |
| Selenium (Se) | 2.0 | ug/l | nd | 102% | nd | 100% | 100% | 0.2% |
| Silver (Ag) | 2.0 | ug/l | nd | 100% | nd | 88% | 83% | 6% |
| Thallium (Tl) | 1.0 | ug/l | nd | 103% | nd | 96% | 97% | 0.8% |
| Zinc (Zn) | 5.0 | ug/l | nd | 104% | 14 | 90% | 91% | 0.9% |
| Mercury (Hg) | 0.20 | ug/l | nd | 99% | nd | 88% | 88% | 0.9% |
| Barium (Ba) | 5.0 | ug/l | nd | 103% | 49 | 101% | 94% | 8% |

Acceptable Recovery Limits:

| | |
|-----------------------|---------|
| LCS | 80-120% |
| MS/MSD | 75-125% |
| Acceptable RPD limit: | 20% |

*This report is issued solely for the use of the person or company to whom it is addressed.
Any use, copying or disclosure other than by the intended recipient is unauthorized.*



12524 130th Lane NE
Kirkland WA 98034

Tel: (425) 214-5858
(425) 214-5868
Email: lisa@accu-lab.com
website: www.accu-lab.com

Analytical Report

| | | | |
|------------------------|---------------------------------------------------------------------------------------|----------------------|--------------------|
| Client | Advanced Analytical Laboratory 544 Ohohia Street #10 Honolulu, HI, 96819 | Acculab WO# | 22-AL0106-4 |
| Project Manager | Uwe Baumgartner/ Elisa Young | Date Sampled | 1/4/2022 |
| Project Name | Aptim Red Hill Hydrotest water 303472-01 | Date Received | 1/6/2022 |
| Project# | X7 | Date Reported | 1/7/2022 |

pH by SM4500-H+ B

| Client sample ID | Accu Lab ID | Matrix | pH | Date Analyzed | Note |
|------------------|---------------|--------|-----|---------------|------|
| Tank 01 | 22-AL0104-8-1 | Water | 7.0 | 1/6/2022 | |

*This report is issued solely for the use of the person or company to whom it is addressed.
Any use, copying or disclosure other than by the intended recipient is unauthorized.*



12524 130th Lane NE
Kirkland WA 98034

Tel: (425) 214-5858
(425) 214-5888
Email: lisa@accu-lab.com
website: www.accu-lab.com

Analytical Report

| | | | |
|------------------------|--------------------------------------------------------------------------------|----------------------|--------------------|
| Client | Advanced Analytical Laboratory 544 Ohohia Street #10 Honolulu, HI, 96819 | Acculab WO# | 22-AL0106-4 |
| Project Manager | Uwe Baumgartner/ Elisa Young | Date Sampled | 1/4/2022 |
| Project Name | Aptim Red Hill Hydrotest water | Date Received | 1/6/2022 |
| Client Project# | 303472-01 | Date Reported | 1/7/2022 |
| Project# | X7 | | |

Data Qualifiers and Comments:

- MRL-** Method Reporting Limit
- nd-** Indicates the analyte is not detected at the listing reporting limit.
 - C-** Coelution with other compounds.
 - M-** % Recovery of surrogate, MS/MSD is out of the acceptable limit due to matrix effect.
 - B-** Indicates the analyte is detected in the method blank associated with the sample.
 - J-** The analyte is detected at below the reporting limit.
 - E-** The result reported exceeds the calibration range, and is an estimate.
 - D-** Sample required dilution due to matrix. Method Reporting Limits were elevated due to dilutions.
 - H-** Sample was received or analyzed past holding time
 - Q-** Sample was received with head space, improper preserved or above recommended temperature.
 - I-** Due to insufficient sample, LCS/LCS DUP were analyzed in place of MS/MSD.
 - R-** The recovery of this analyte in QC sample failed high, but the analyte was not detected in all related samples. No action was taken.
 - R-1-** The RPD value for the MS/MSD was outside of QC acceptance limits however both recoveries were acceptable. All related samples were "nd". No action was taken.
 - R-2-** The recovery of the surrogate in sample failed high, but all related analytes were not detected in the sample. No action was taken.